

Modifikations for the bandpassfilters in K2

Some bandpassfilters in the K2 are not optimal but can easily be modified. I found some mod's on Elecraft's homepage /1/ and in the internet /2/, other mods resulted from my own experiments. The alignment requires a sweeper for best performance, the tuning for maximum at only one frequency - as described in the K2-manual - may result in distorted curves, especially when they are broad and „double-humped“.

The following modifications have been made in my K2 with S.-Nr. 3191.

1. 10m-/12m-BPF

The 10m-BPF is too narrow – especially for satellite-downlink at 29.500MHz.

Some builders propose to increase C45 from 1pF to app. 2pF.

That's correct but affects also the 12m-BPF, which becomes „double-humped“ with a bandwidth greater than 500kHz(!), but the 12m-BPF is too broad even with C45 = 1pF.

Therefore it's proposed to reduce C45 = 0,75pF (better for 12m) and to install an additional C=2,2pF at pins 4 and 7 of K6 (at the bottom, see picture 7). This C is only active on 10m (in series with C44 and C46) and increases C45 to 2pF. On 12m the C is grounded via K6 and therefore not active (picture 1). The C45 is realised by two C=1p5 in series (picture 2).

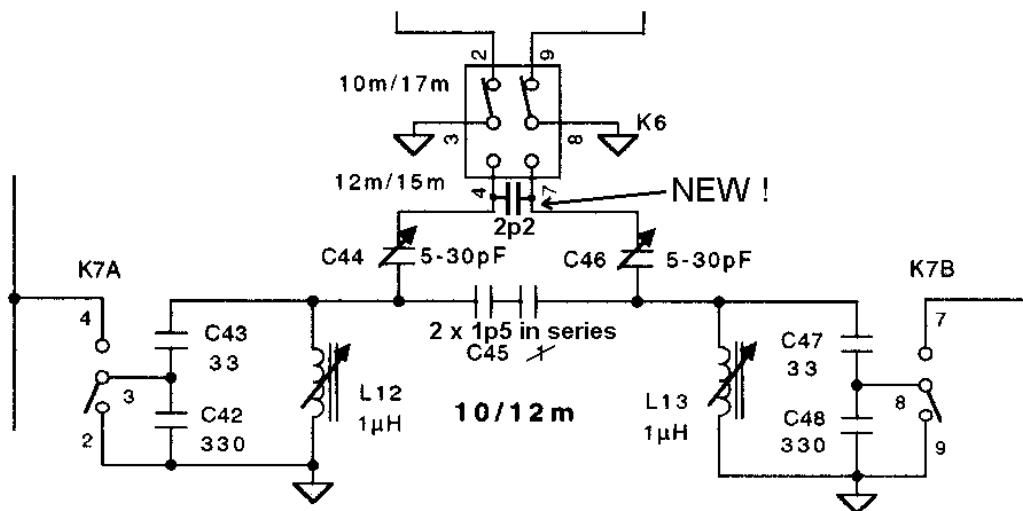

Picture 1: 10m/12m-BPF-Modifications

Unfortunately the additional C is in series with the trimmers. But their values are much larger than 5pF, so the resulting capacity C44 – 2p2 – C46 is app. 2pF. A value of 1p8 or 2p7 can also be chosen for the C, it depends on the tolerances and the required bandwidth on 10m.

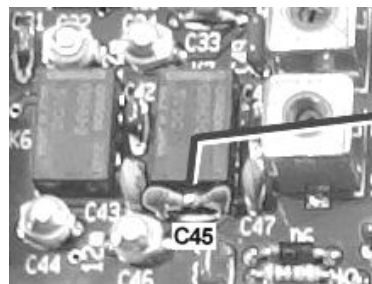

C45:
replace
by 2x1,5p
in series

Picture 2: C45

2. 15m-/17m-BPF

The BPF is too broad on 15m and on 17m. A change of C33 from 2,2pF to 1,5pF is proposed (picture 3).

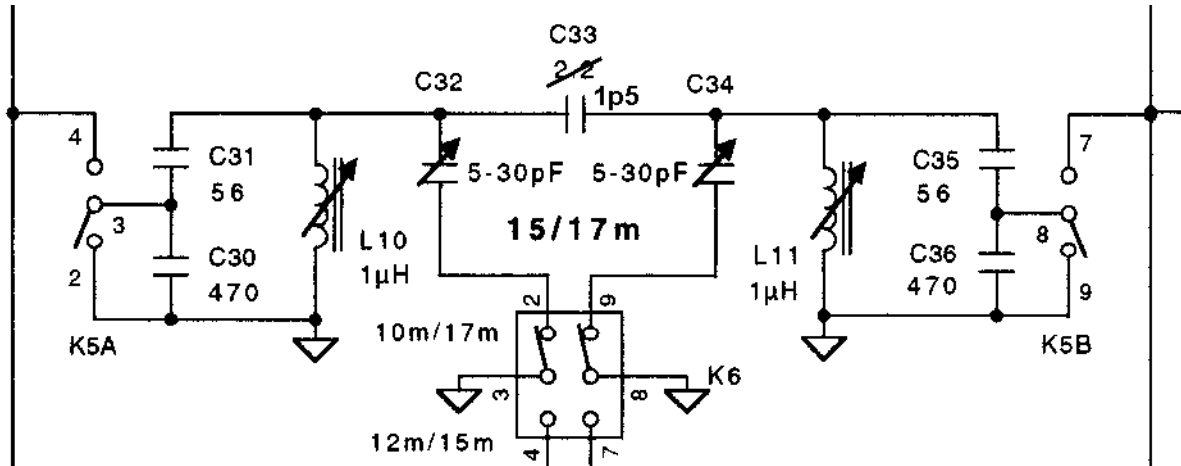

Picture 3: 15m/17m-BPF-Modifications

3. 20m-/30m-BPF

The BPF is too wide on both bands. It's proposed to increase C19/C25 to 470pF and to reduce C22 to 2,2pF. But this is too broad for 30m and too small for 20m. I changed C19/C25 to 470pF and C22 to 1pF (good for 30m) and connected an additional C=1,5pF at the pins 4 and 7 of K3 (at the bottom, see picture 7). This C is only active on 20m and gives sufficient bandwidth on 20m (picture 4).

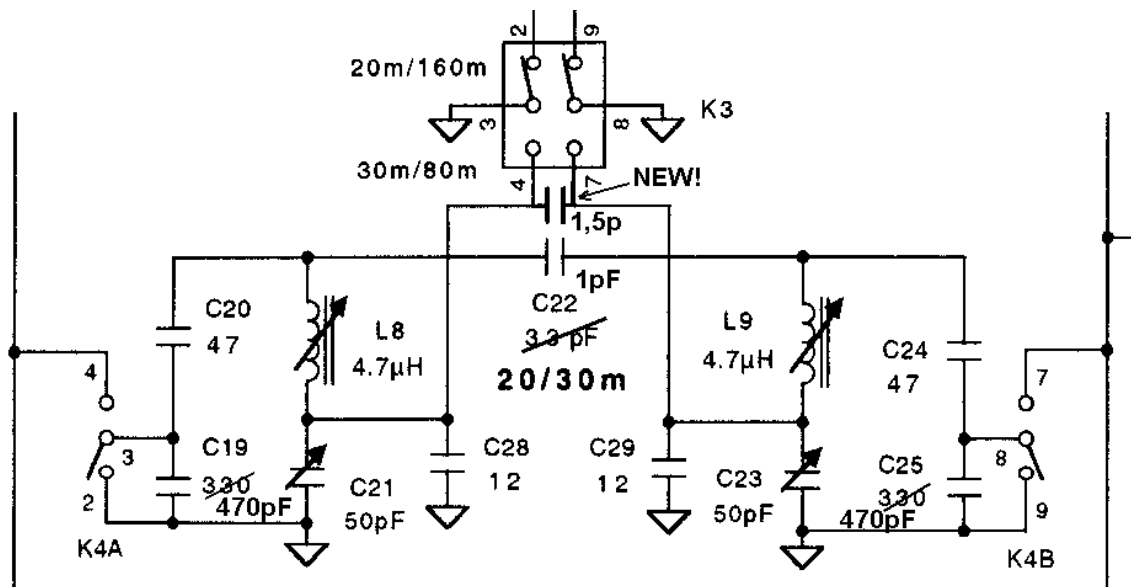

Picture 4: 20m/30m-BPF-Modifications

4. 40m-BPF

The original 40m-BPF is more than 300kHz broad. For us in Europe, a bandwidth of 100kHz or 200kHz is required. Some K2-builders propose following values for the C's in the BPF:

C4, C8 = 1500pF, C5, C7 = 120pF, C6 = 2,2pF.

This will result in a bandwidth of app. 100kHz.

With C6 = 3p3 (C4, C8 = 1500pF, C5, C7 = 120pF), the Bandwidth will increase to app. 200kHz (picture 5).

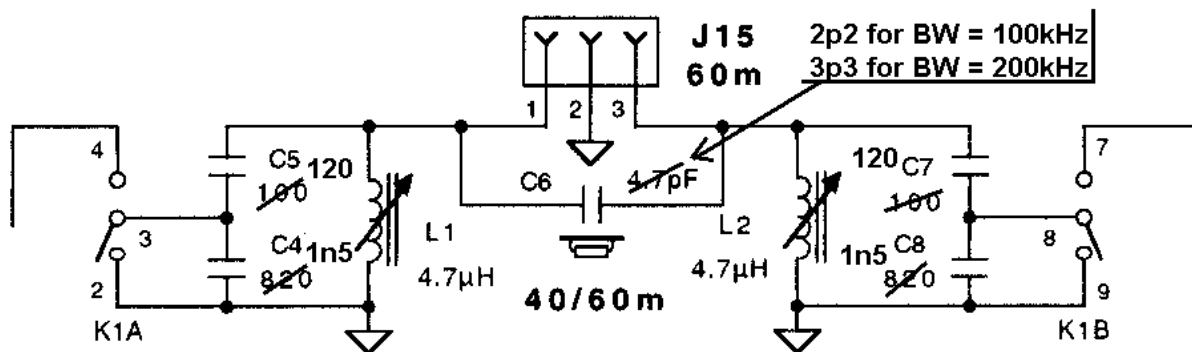

Picture 5: 40m-BPF-Modification / B = 100kHz and 200kHz

The effect on the 60m-option is not known to me.

5. 80m-/160m-BPF

5.1. „Narrow“-version for 160m

The original bandwidths for 80m (500kHz) and 160m (250kHz) are too broad for us.

The inductor L5 = 33µH in the 160-/80m-BPF is a compromise between 80m and 160m.

Therefore it's proposed to use two inductors: A value of app. 40µH is required for 80m and 68µH for 160m. This can be achieved by replacing L5 with a L = 68µH and an additional L = 82µH at the pins 2 and 9 of K3 (at the bottom, see picture 7).

Principle (picture 6):

On 160m the additional L is grounded and not effective. Therefore on 160m only L5 = 68µH is active (together with C13/C14).

On 80m the additional L = 82µH is in parallel with L5, so the resulting inductivity is $68 // 82 \mu\text{H} = 37 \mu\text{H}$. The both C's (C13, C14) in series with the additional L are not very essential, because their capacitive reactance is much lower than the inductive reactance of 82µH.

The two C's C11 and C16 should be increased from 1800pF to 3900pF for a better Q of the circuits.

Additionally for 160m, two capacitors C = 120pF are proposed in parallel with C13 and C14 (at the bottom, see picture 7) for a lower BPF-centerfrequency.

5.2. „Wide“-version for 160m

If a bandwidth of 200kHz (1810 ... 2000kHz) is required, it's proposed to change L5 to 47uH and add also the two capacitors with 150p. The additional inductor (82uH) – added in the „narrow“-version - is not necessary for the „wide“-version.

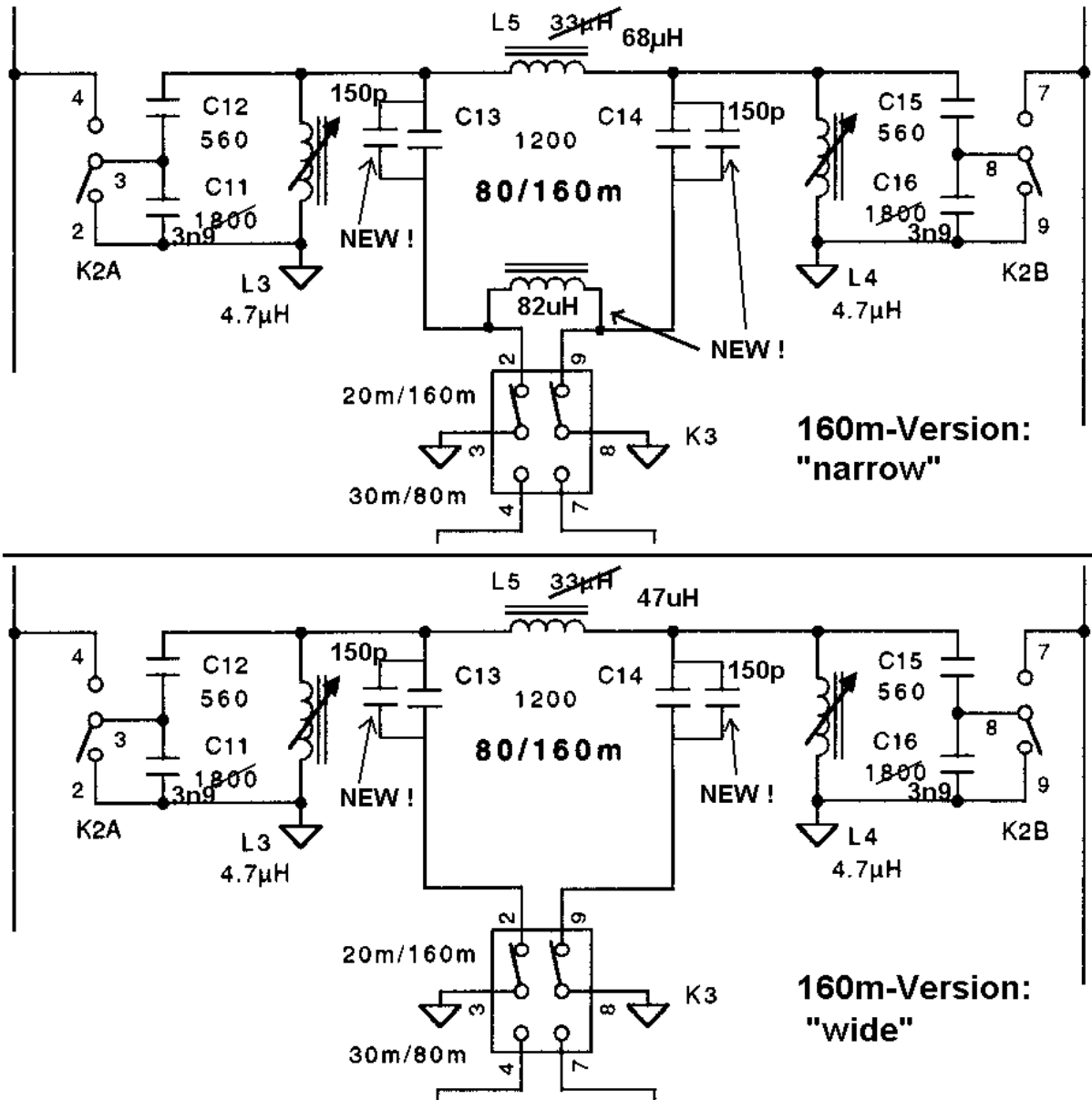

Picture 6: 80m/160m-BPF-Modifications

In both 160m-versions, the resulting bandwidth on 80m is 300kHz.

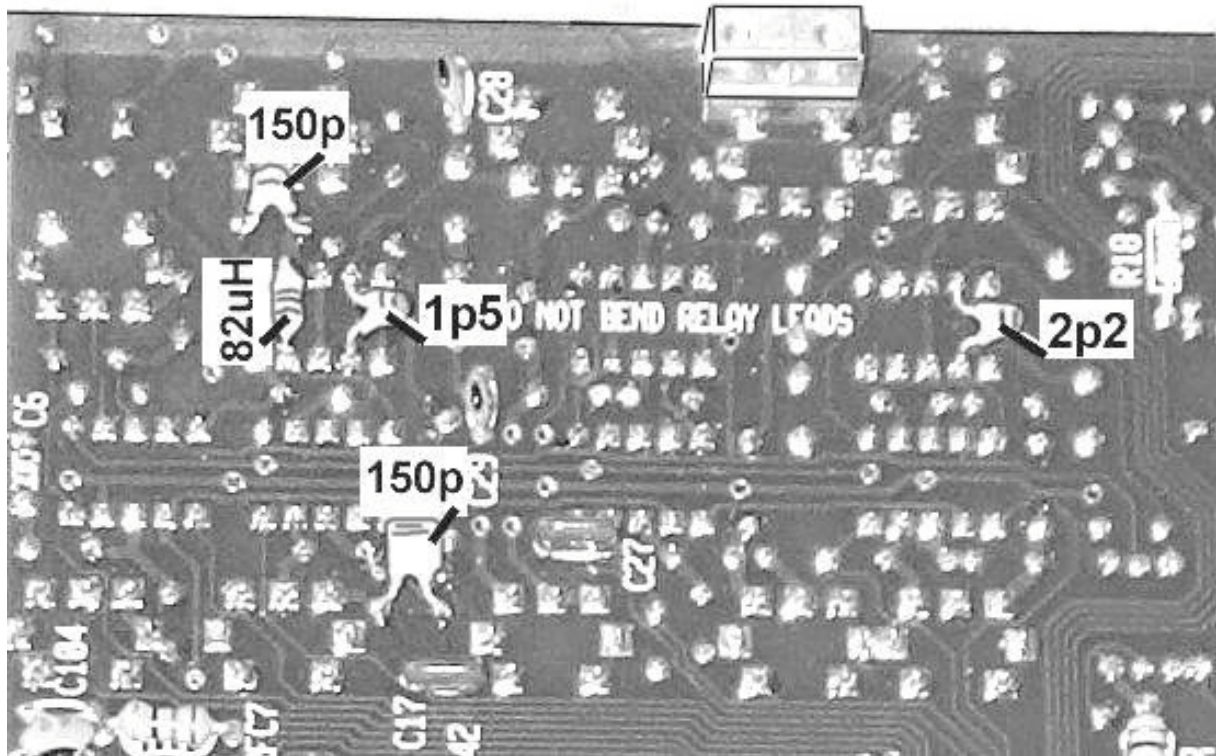

Picture 7: Additional components for 160m, 80m, 20m and 10m

Note: The Inductor 82uH is only necessary for narrow-Version for 160m

6. How to align the BPF's

As mentioned before, the optimal filter-alignment requires a sweeper.
Here is the connection of a sweeper or generator and the probe (1MOhm):

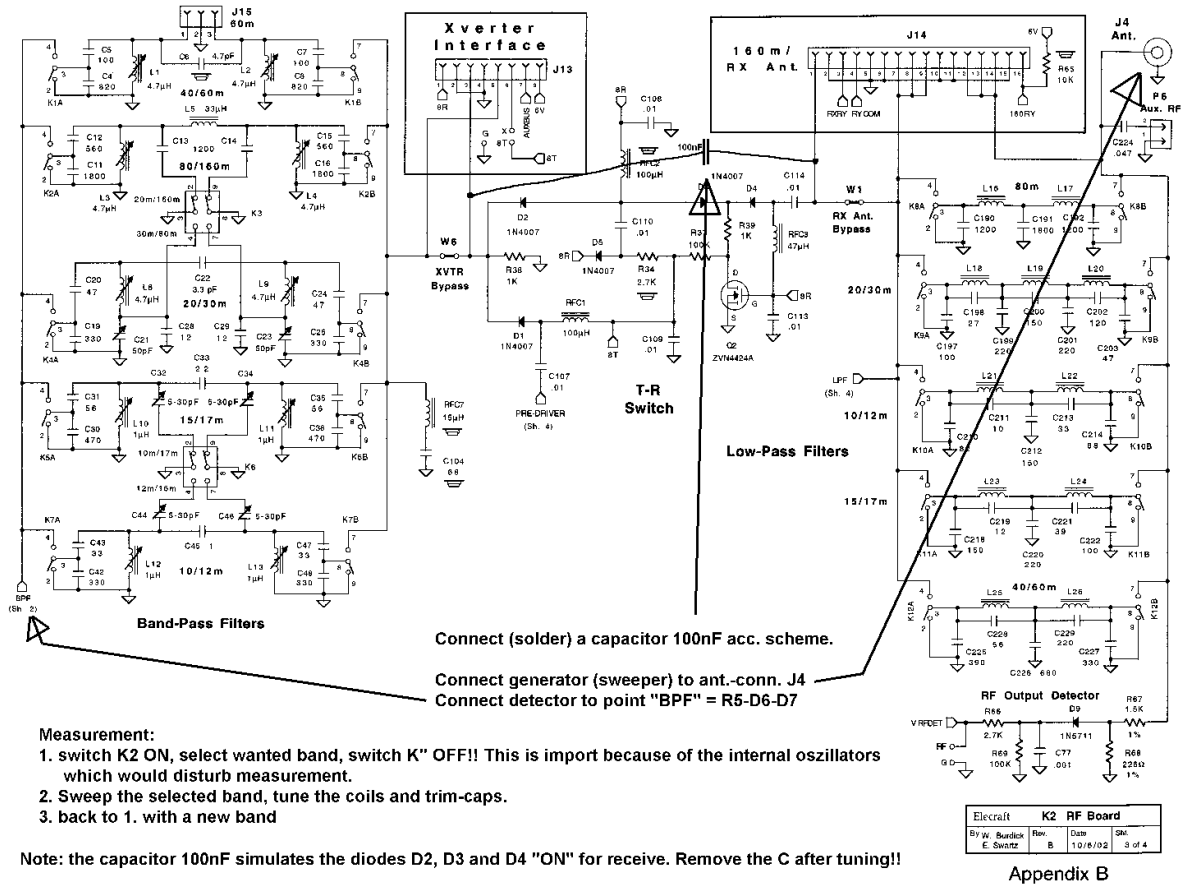

Picture 8: Schematic for connection of sweeper

An additional capcopr only for measurement is proposed. Then it's possible to switch the K2 off during measurements; the latching relays hold the selected band.
See also picture 8 and 9.

NOTE:

When the K2 is switched on, the curves are damped because of the load of the mixer-input.
So the tuning should be done with the K2 Off and be checked, when the K2 is on.

My experience is, that only the amplitudes but not the centerfrequencies of the BPF's are affected.

Don't forget to remove the 100nF after alignment!!

Alignment-procedure (proposed):

The K2 is always switched OFF during alignment. Only for selection of the band, the K2 is switched on and then off again.

A. 10/12m-alignment:

First align 10m-band with L12 and L13 .

Then align 12m-band with C44 and C46.

Go back to 10m-band and realign L12 and L13 if necessary, because C44/C46 have an influence (via the new C) also on the 10m-Band.

Then align 12m-band with C44 and C46 again.

Repeat steps above, until no more alignment is necessary – should be the case after two or three reruns.

B. 15/17m-alignment:

First align 15m-band with 10 and L11.

Then align 17m-band with C32 and C34.

C. 20/30m-alignment:

First align 30m-band with L8 and L9.

Then align 20m-band with C21 and C23.

D. 40m.-alignment:

Align L1 and L2.

Note: The curve should be shifted down some kHz for the purpose of more attenuation for BC-stations.

E. 80/160m-alignment:

The alignment has an influence on both bands, therefore the 80m-band should be aligned first. Then check 160m, whether it's OK – if not, the two additional C's (here: 150pF) should be modified. Higher values result in a lower frequency on 160m and viceversa. Both C's are proposed to be equal.

„Narrow“ for 160m:

Alternatively the inductors can be modified for the bandwidth. More inductivity result in a smaller coupling and therefore in a smaller bandwidth and viceversa.

Note that L5 is active both on 160m and 80m and the additional L (here: 82uH) is active only on 80m. That means if you want to change bandwidth on 160m you have to change L5 AND change the additional L also for the wanted bandwidth on 80m. If you want to change the bandwidth on 80m, it's sufficient to change the additional L.

„Wide“ for 160m:

There is only one coupling inductor (L5) for both bands.

That means, the bandwidths for 160m and 80m can only be changed in parallel.

The increased bandwidth for 160m causes a double-humped filter-curve; the maximum relative loss is 6dB, which is only one S-unit and should not be critical.

The resulting bandwidth for 80m is (nearly) independent from the 160m-version – see pictures for 80m „wide“ and „narrow“ at the end of this document.

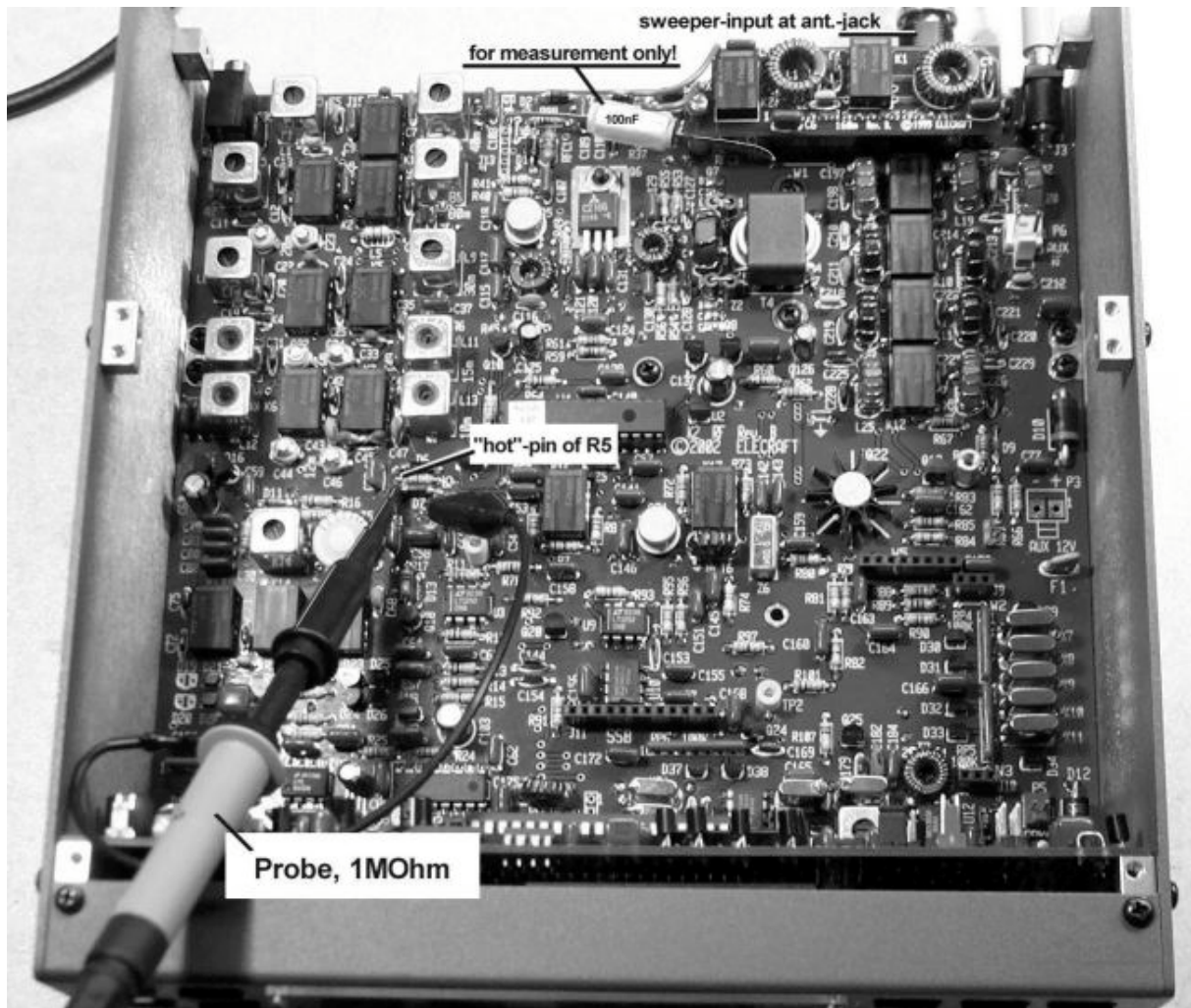

Picture 9: Connection of sweeper and probe for detector

Don't forget to remove the 100nF after alignment!!

7. Method and results of Measurements

The following pictures show the actual BPF-curves after the modifications and alignment with a sweeper as described above.

They have been measured from the antenna-jack to the AF-output of the K2 according the scheme in picture 10.

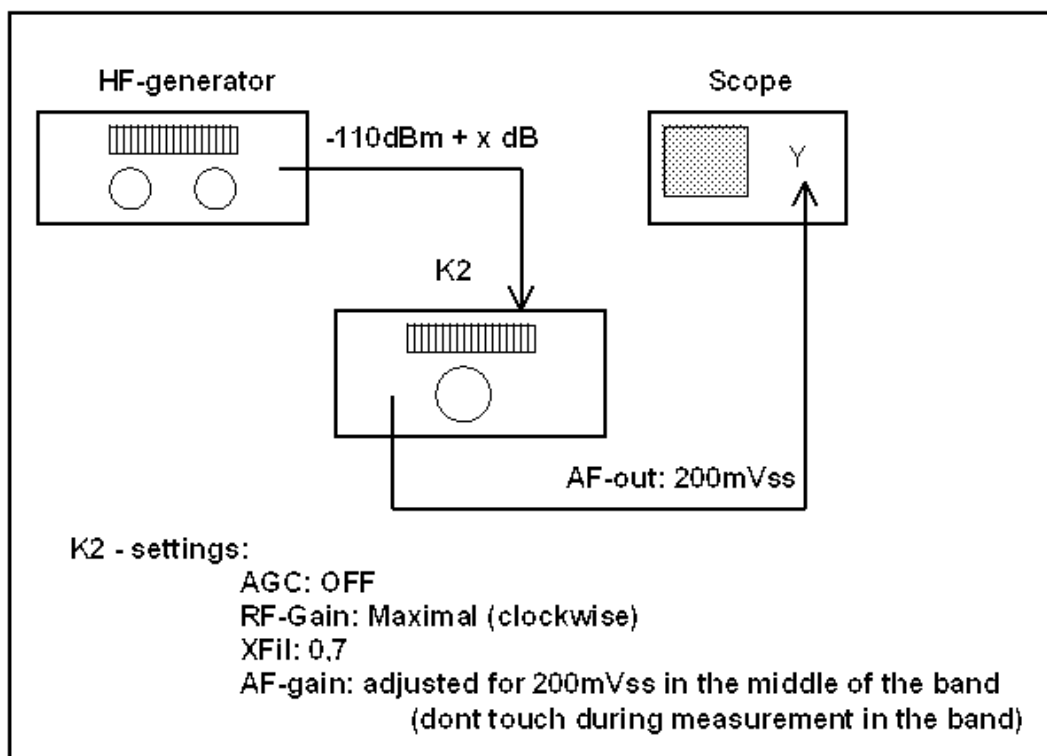

Picture 10: BPF-measurement

The K2 is set acc. Picture 10. In the middle of each band (most sensitive frequency), the K2 is maximum-tuned to the HF-generator at -110dBm and it's audio-output is set to 200mVss on the scope (look for distortions, ignore the noise). Then the generator is set and the K2 is (maximum) tuned to the various frequencies. The output of the HF-generator is increased at each measuring point, until the audio reaches the same amplitude as before.

The settings of the AF- and RF-gain may not be changed!

The K2 must operate with constant gain from RF-in to AF-out !

The necessary increase of the HF-generator-output (in dB) at the various frequencies for a constant AF-output gives a true image of the BPF-selection in the K2.

Unfortunately, the frequencyrange is limited because of the PLL in the K2.

Don't align the filters according the K2-manual and keep your fingers away from the filters after alignment with a sweeper!

Filtercurves

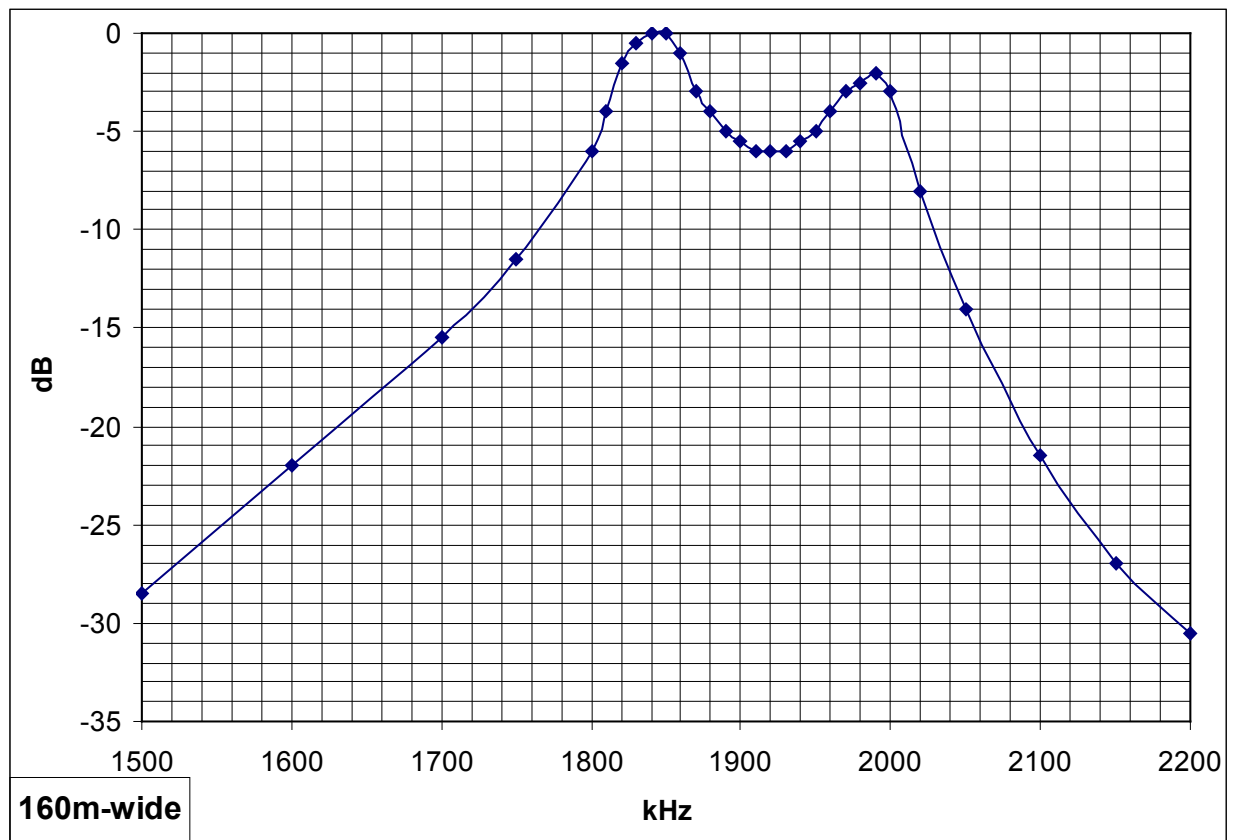
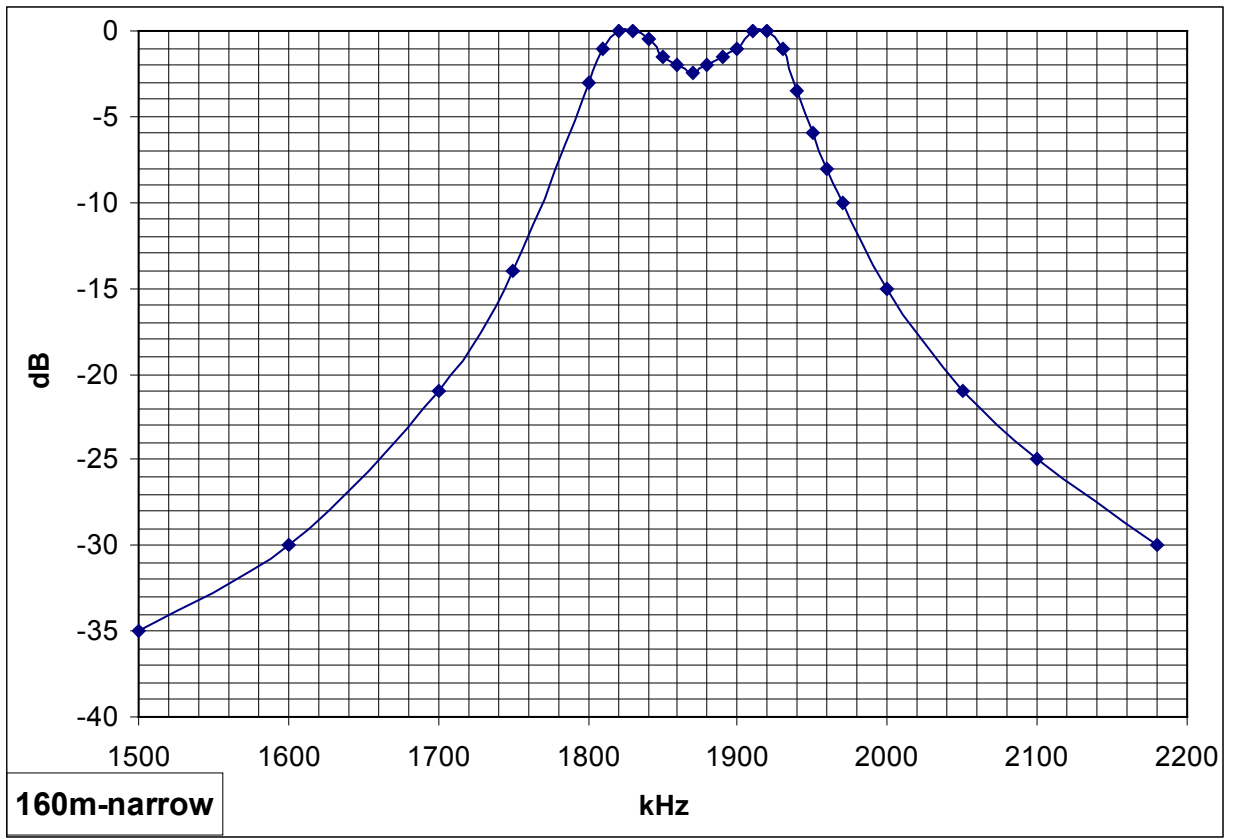

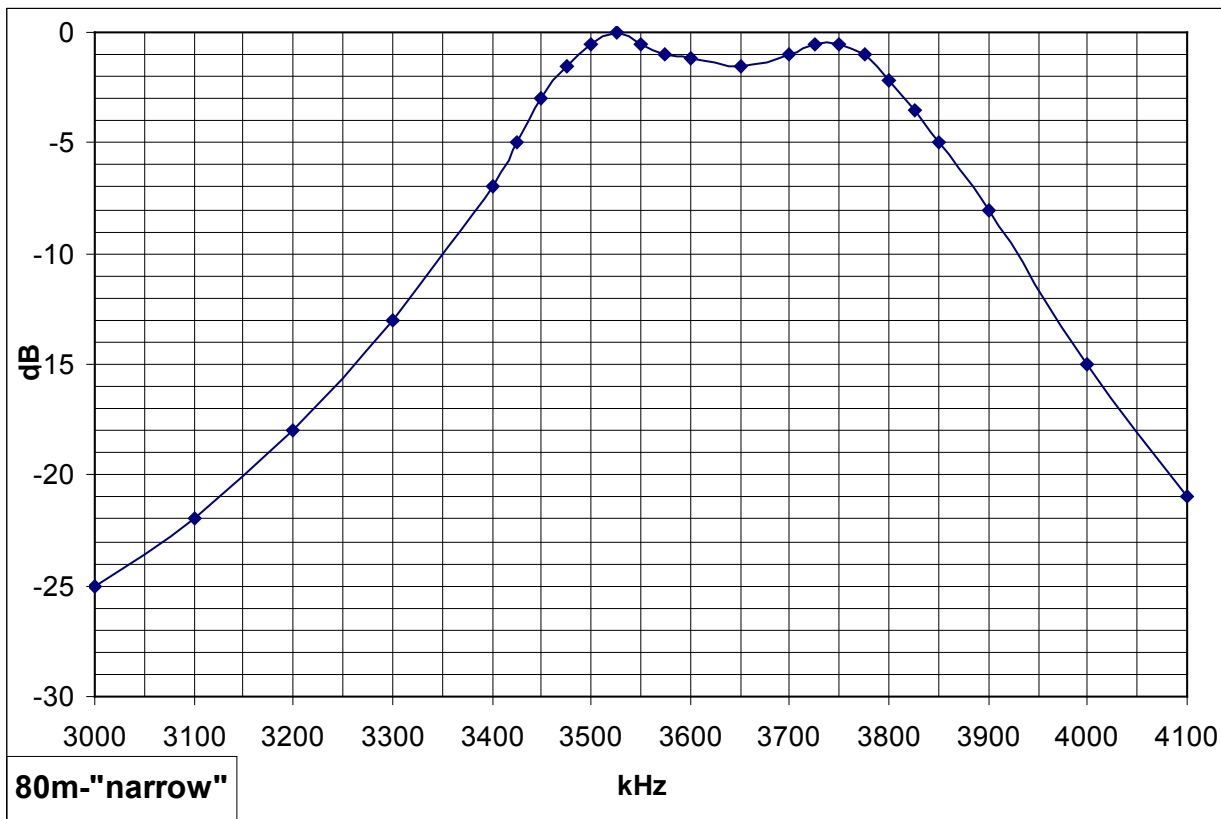

„narrow“ and „wide“ refers to Mods on 160m; on 80m both BW's are nearly identical

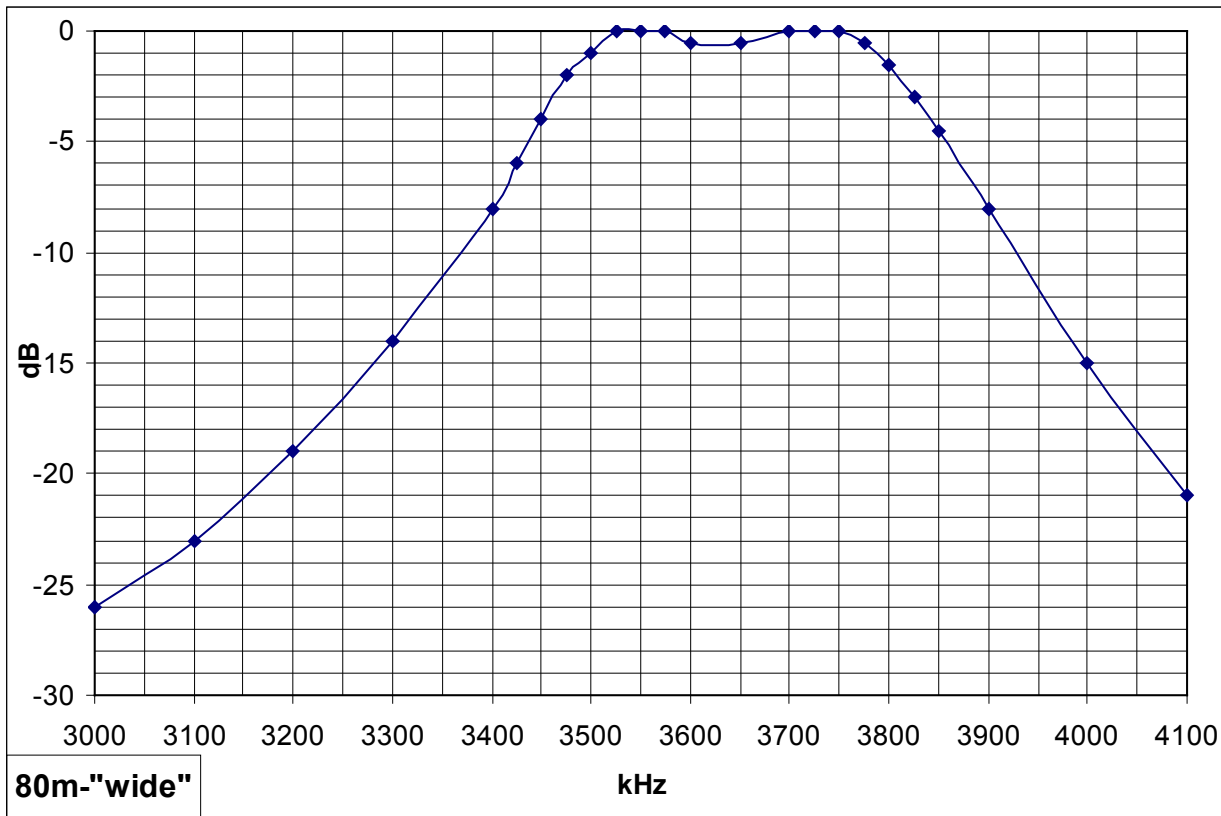

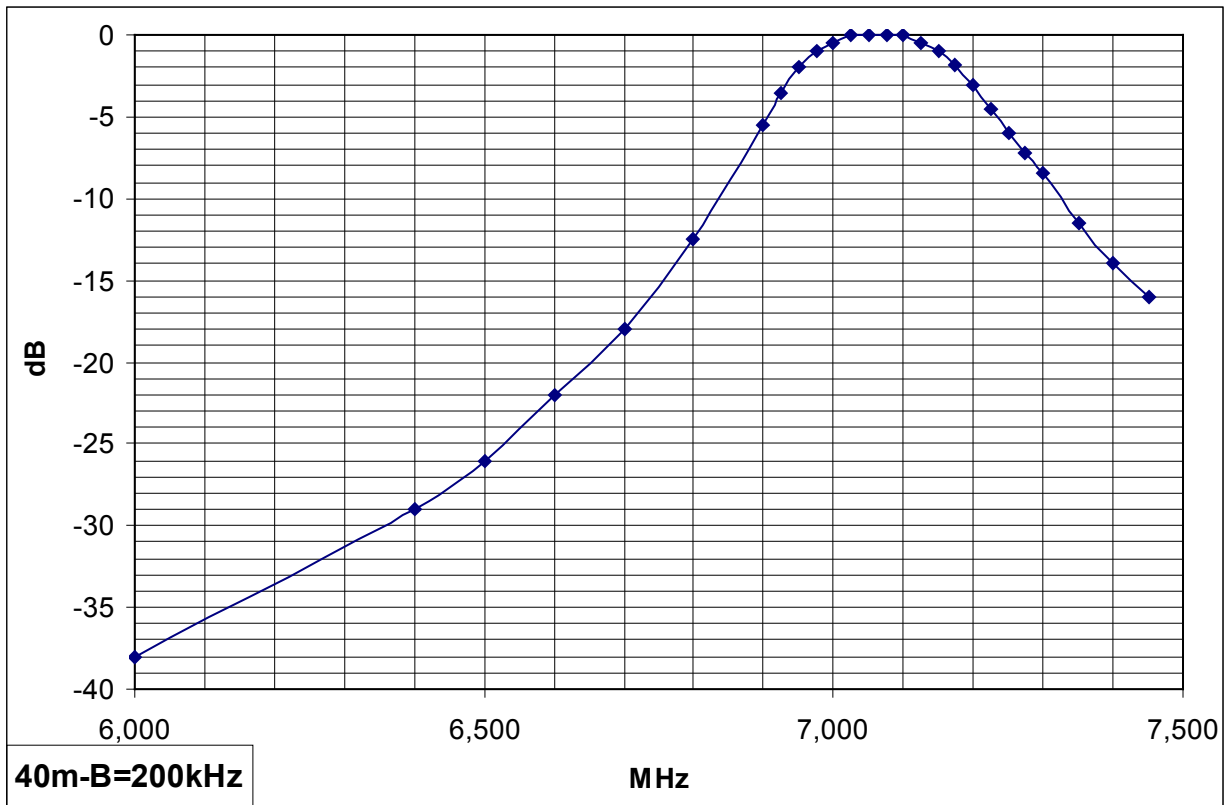
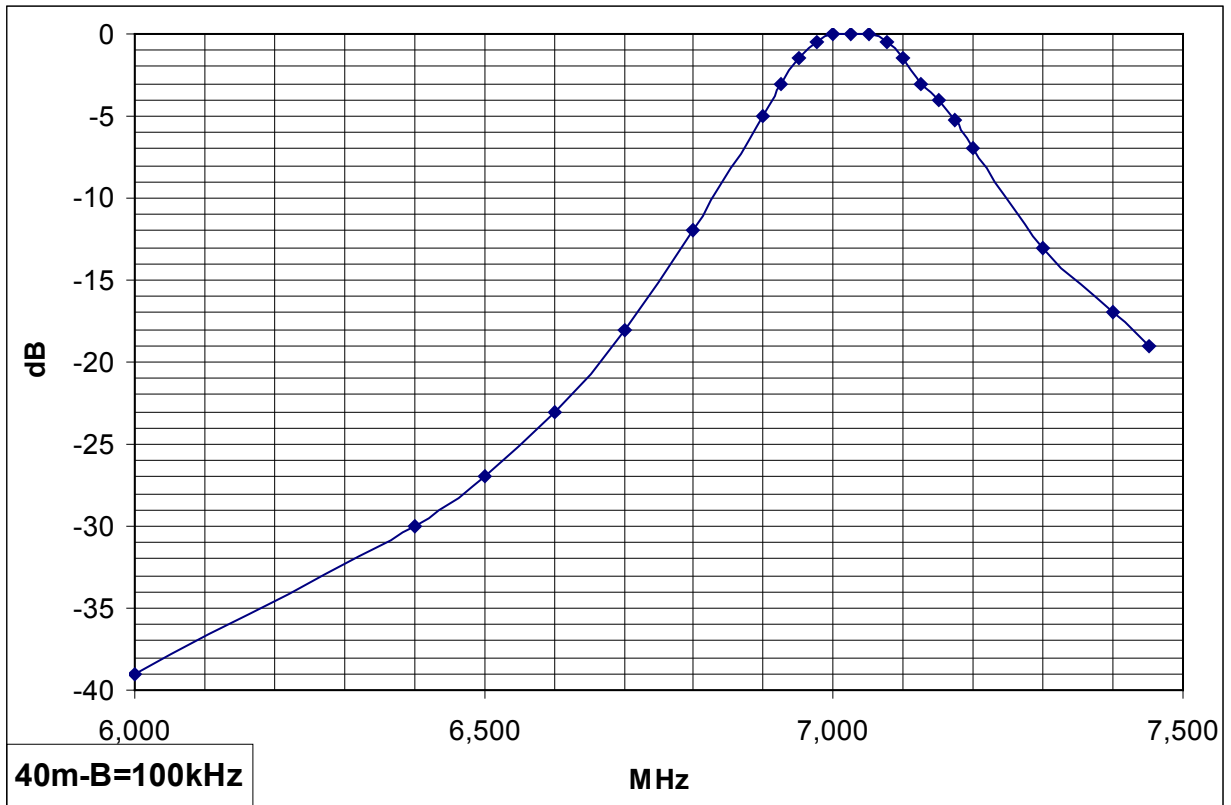

(The curves are shifted down some kHz for the purpose of more attenuation for BC-stations)

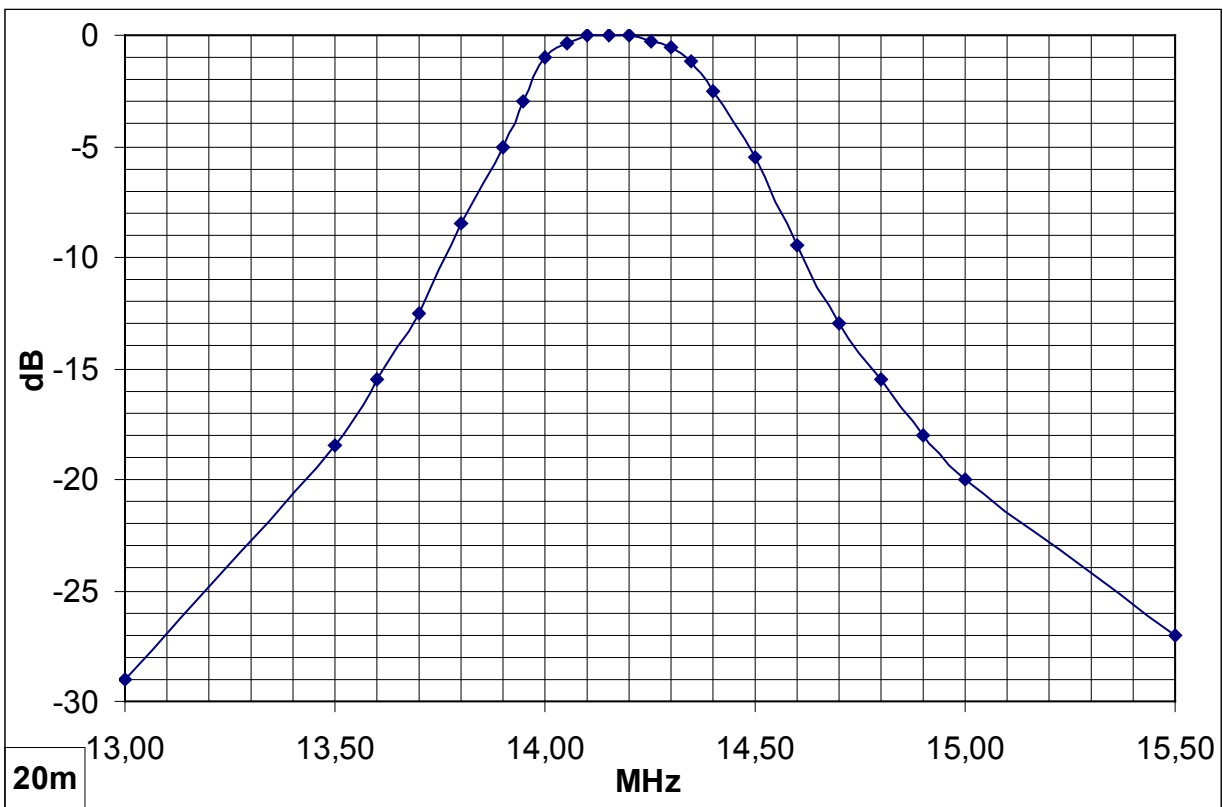
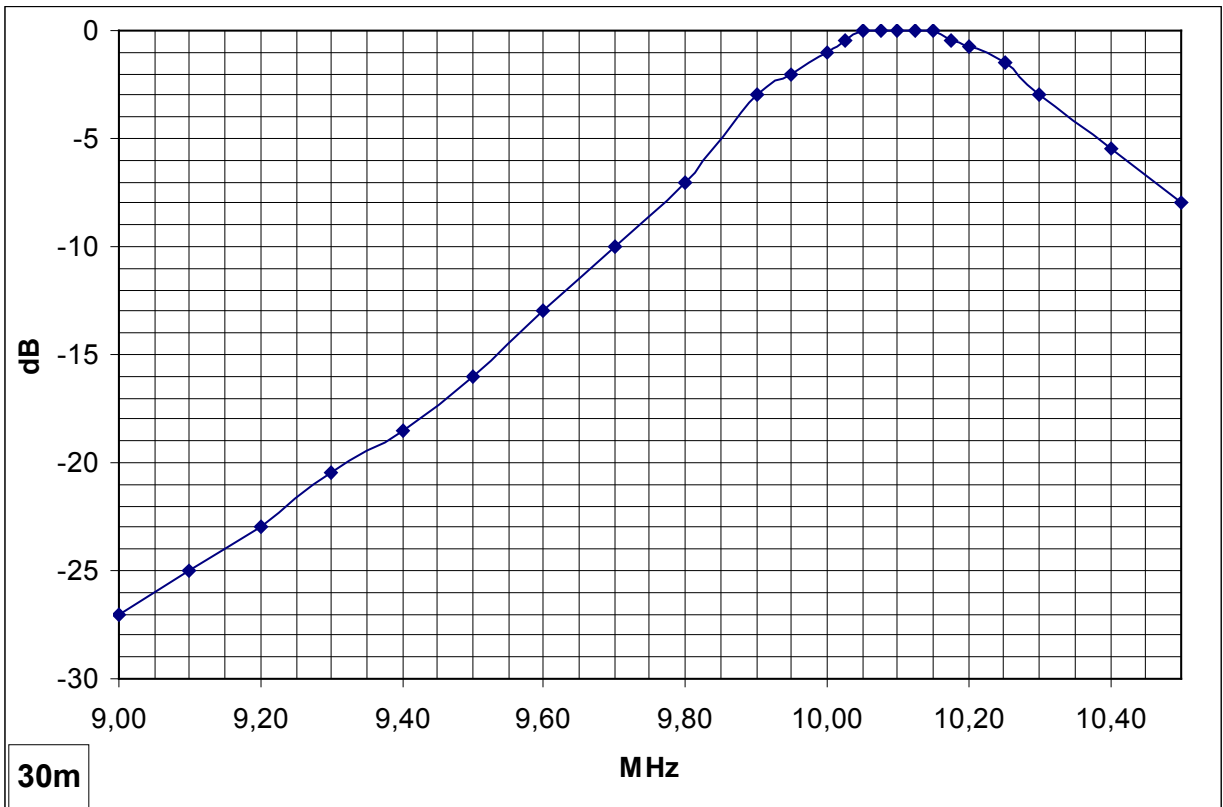

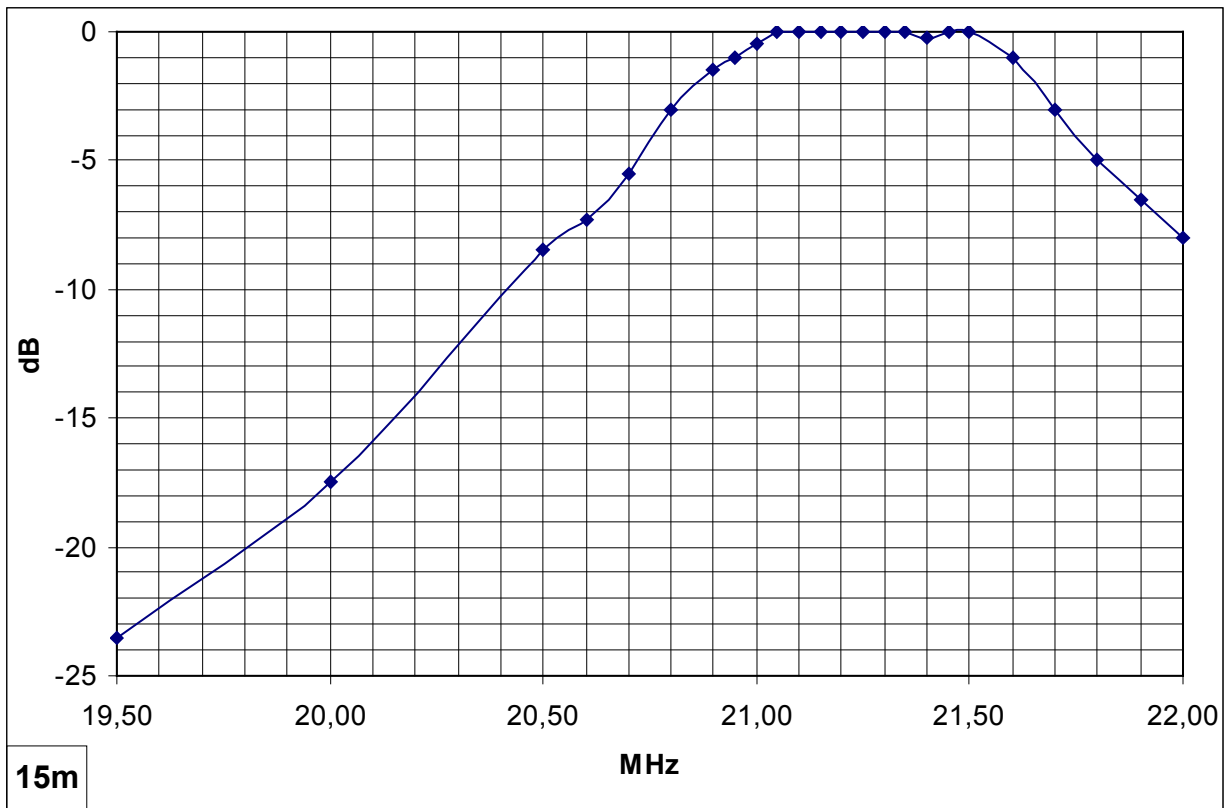
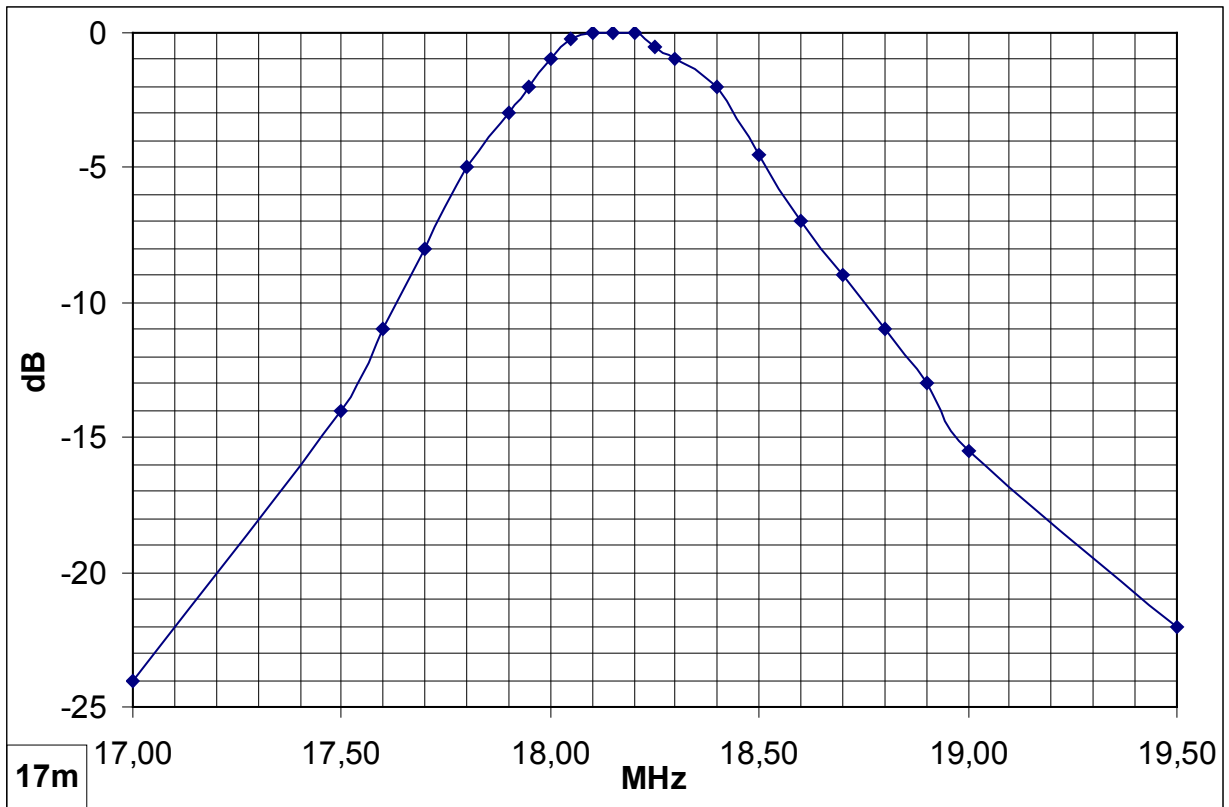

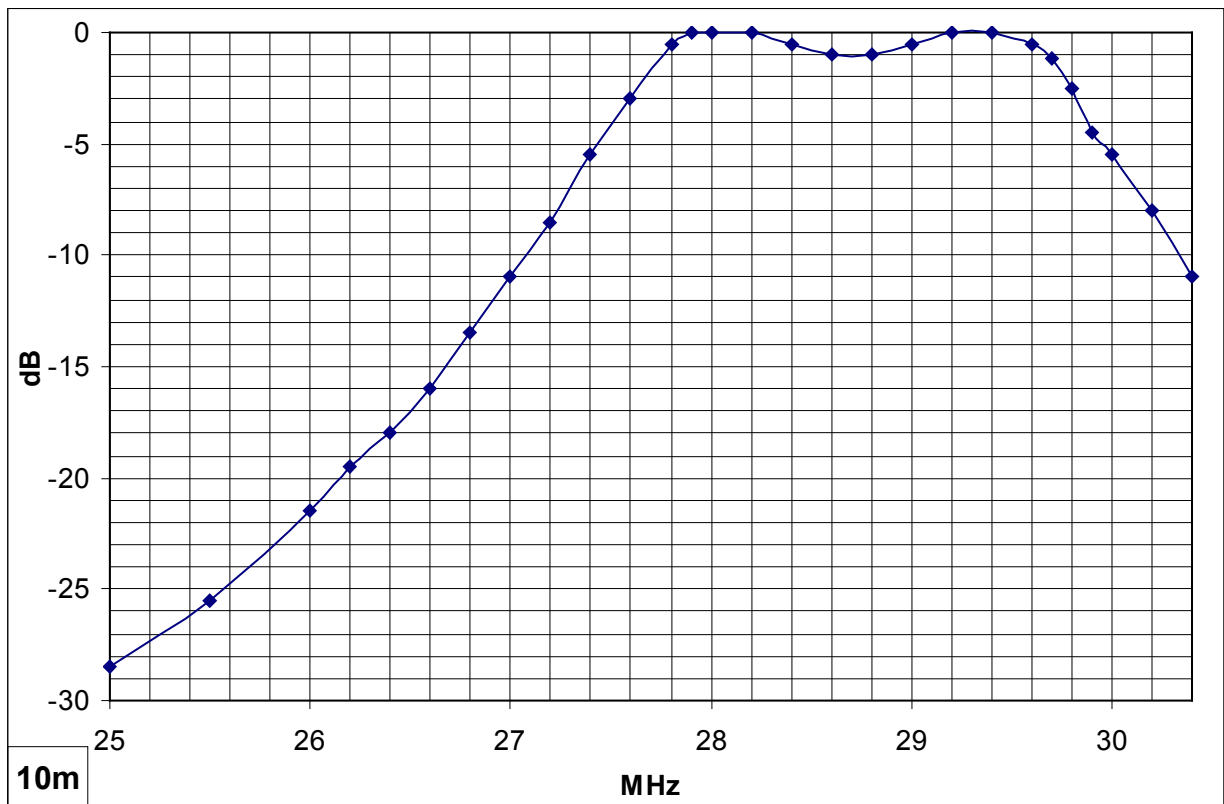
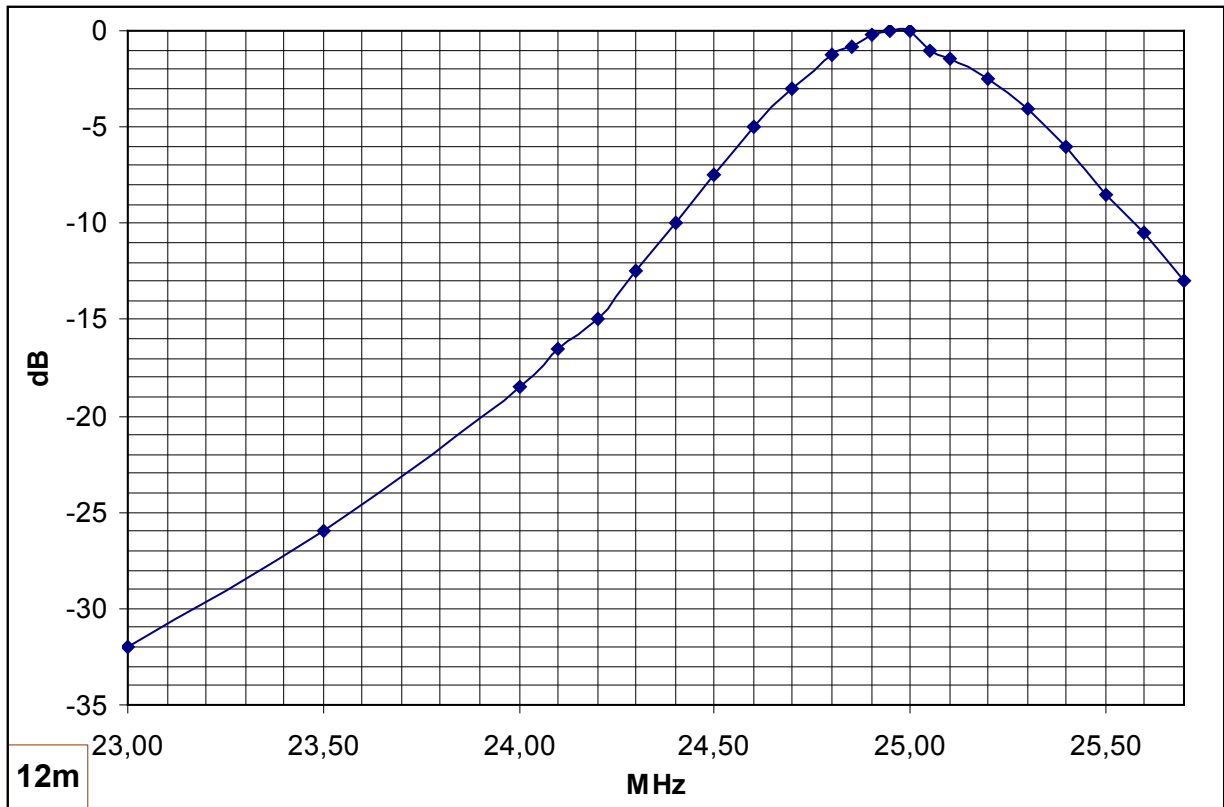

Ham-bands in Germany

160m: 1.810 – 2.000kHz
80m: 3.500 - 3.800kHz
40m: 7.000 - 7.100kHz; in future: 7.000 – 7.200kHz
30m: 10.100 - 10.150kHz
20m: 14.000 - 14.350kHz
17m: 18.068 - 18.168kHz
15m: 21.000 - 21.450kHz
12m: 24.890 – 24.990kHz
10m: 28.000 – 29.700kHz

More information: www.darc.de/bandplan

If you want to contact the author:
Stefan Steger, DL7MAJ, eMail: dl7maj@darc.de
Homepage: www.dl7maj.de (german language)

Internet-sources:

/1/ www.elecrafft.com
/2/ www.qsl.net/la3za/k2/mod.html

Revisions:

Rev.		date
A	Changed modifications for 160m and 40m. Caused by increased bandwidths (new regulations) in Germany	06/18/2006