

HIGH FREQUENCY 7660 DC-TO-DC VOLTAGE CONVERTER

FEATURES

- Pin Compatible with 7660, High Frequency Performance DC-to-DC Converter
- Low Cost, Two Low Value External Capacitors Required (1.0 μ F)
- Converts +5V Logic Supply to \pm 5V System
- Wide Input Voltage Range 1.5V to 10V
- Voltage Conversion 99.7%
- Power Efficiency 85%
- Available in 8-Pin SOIC and 8-Pin PDIP Packages

GENERAL DESCRIPTION

The TC7660H is a pin-compatible, high frequency upgrade to the Industry standard TC7660 charge pump voltage converter. It converts a +1.5V to +10V input to a corresponding - 1.5V to - 10V output using only two low-cost capacitors, eliminating inductors and their associated cost, size and EMI.

The TC7660H operates at a frequency of 120kHz (versus 10kHz for the TC7660), allowing the use of 1.0 μ F external capacitors. Oscillator frequency can be reduced (for lower supply current applications) by connecting an external capacitor from OSC to ground.

The TC7660H is available in 8-pin DIP and small outline (SOIC) packages in commercial and extended temperature ranges.

PIN CONFIGURATION (DIP and SOIC)

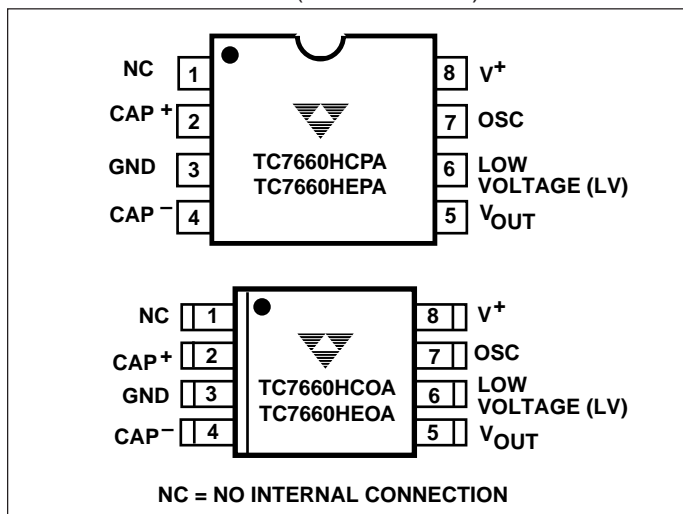

ORDERING INFORMATION

Part No.	Package	Temperature Range
TC7660HCOA	8-Pin SOIC	0°C to +70°C
TC7660HCPA	8-Pin Plastic DIP	0°C to +70°C
TC7660HEOA	8-Pin SOIC	- 40°C to +85°C
TC7660HEPA	8-Pin Plastic DIP	- 40°C to +85°C
TC7660EV	Evaluation Kit for Charge Pump Family	

FUNCTIONAL BLOCK DIAGRAM

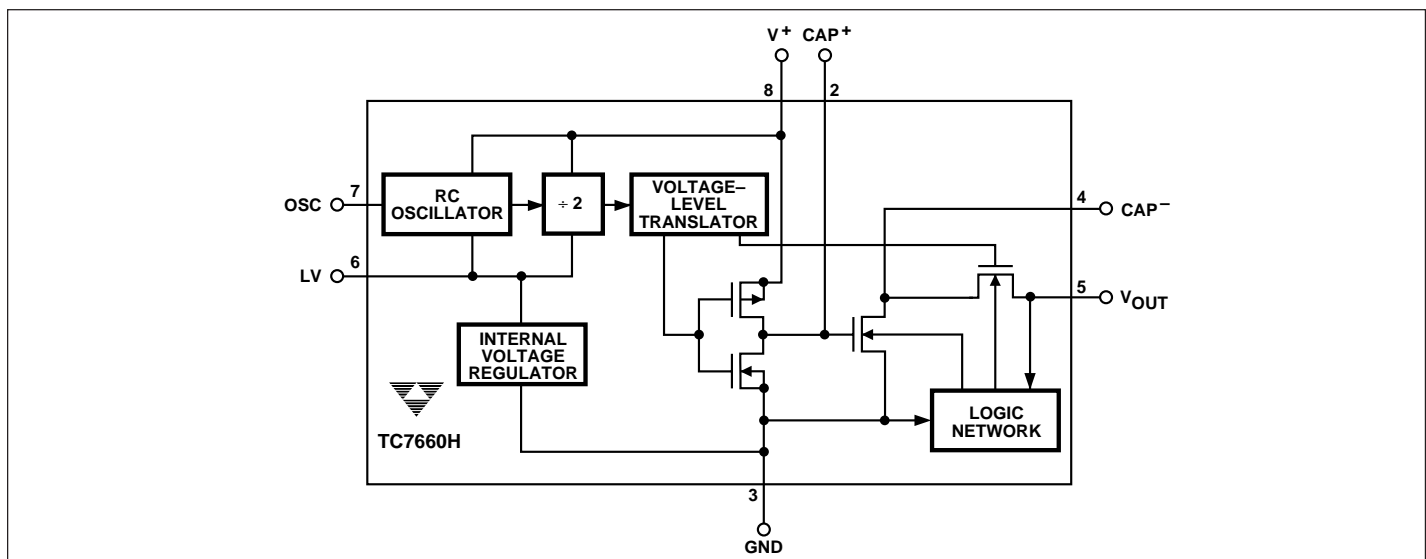

HIGH FREQUENCY 7660 DC-TO-DC VOLTAGE CONVERTER

TC7660H

ABSOLUTE MAXIMUM RATINGS*

Supply Voltage	+10.5V
LV and OSC Inputs	
Voltage (Note 1)	- 0.3V to (V ⁺ + 0.3V)
	for V ⁺ < 5.5V
	(V ⁺ - 5.5V) to (V ⁺ + 0.3V)
	for V ⁺ > 5.5V
Current Into LV (Note 1)	20μA for V ⁺ > 3.5V
Output Short Duration (V _{SUPPLY} ≤ 5.5V)	Continuous
Power Dissipation (T _A ≤ 70°C) (Note 2)	
SOIC	470mW
Plastic DIP	730mW

Operating Temperature Range

C Suffix	0°C to +70°C
E Suffix	- 40°C to +85°C
Storage Temperature Range	- 65°C to +150°C
Lead Temperature (Soldering, 10 sec)	+300°C

*Static-sensitive device. Unused devices must be stored in conductive material. Protect devices from static discharge and static fields. Stresses above those listed under "Absolute Maximum Ratings" may cause permanent damage to the device. These are stress ratings only and functional operation of the device at these or any other conditions above those indicated in the operation sections of the specifications is not implied. Exposure to absolute maximum rating conditions for extended periods may affect device reliability.

ELECTRICAL CHARACTERISTICS: Over Operating Temperature Range with V⁺ = 5V
C₁ = C₂ = 1μF, C_{OSC} = 0, Test Circuit (Figure 1), unless otherwise indicated.

Symbol	Parameter	Test Conditions	Min	Typ	Max	Unit
I ⁺	Supply Current	R _L = ∞	—	0.46	1.0	mA
V _H ⁺	Supply Voltage Range, High	Min ≤ T _A ≤ Max, R _L = 5kΩ, LV Open	3	—	10	V
V _L ⁺	Supply Voltage Range, Low	Min ≤ T _A ≤ Max, R _L = 5kΩ, LV to GND	1.5	—	3.5	V
R _{OUT}	Output Source Resistance	I _{OUT} = 20mA, T _A = 25°C	—	55	80	Ω
		I _{OUT} = 20mA, 0°C ≤ T _A ≤ +70°C (C Device)	—	—	95	Ω
		I _{OUT} = 20mA, - 40°C ≤ T _A ≤ +85°C (E Device)	—	—	110	Ω
		V ⁺ = 2V, I _{OUT} = 3mA, LV to GND 0°C ≤ T _A ≤ +70°C	—	150	250	Ω
F _{OSC}	Oscillator Frequency		—	120	—	kHz
P _{EFF}	Power Efficiency	I _{OUT} = 10mA, Min ≤ T _A ≤ Max	81	85	—	%
V _{EFF}	Voltage Efficiency	R _L = ∞	99	99.7	—	%

- NOTES:**
1. Connecting any input terminal to voltages greater than V⁺ or less than GND may cause destructive latch-up. It is recommended that no inputs from sources operating from external supplies be applied prior to "power up" of the TC7660H.
 2. Derate linearly above 50°C by 5.5mW/°C.

HIGH FREQUENCY 7660 DC-TO-DC VOLTAGE CONVERTER

TC7660H

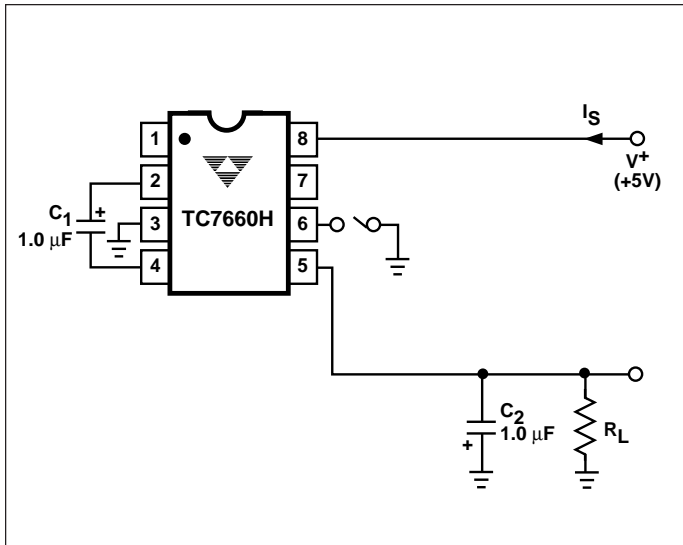

Figure 1. TC7660H Test Circuit

Detailed Description

The TC7660H contains all the necessary circuitry to implement a voltage inverter, with the exception of two external capacitors, which may be inexpensive 1.0μF non-polarized capacitors. Operation is best understood by considering Figure 2, which shows an idealized voltage inverter. Capacitor C₁ is charged to a voltage, V⁺, for the half cycle when switches S₁ and S₃ are closed. (Note: Switches S₂ and S₄ are open during this half cycle.) During the second half cycle of operation, switches S₂ and S₄ are closed, with S₁ and S₃ open, thereby shifting capacitor C₁ negatively by V⁺ volts. Charge is then transferred from C₁ to C₂, such that the voltage on C₂ is exactly V⁺, assuming ideal switches and no load on C₂.

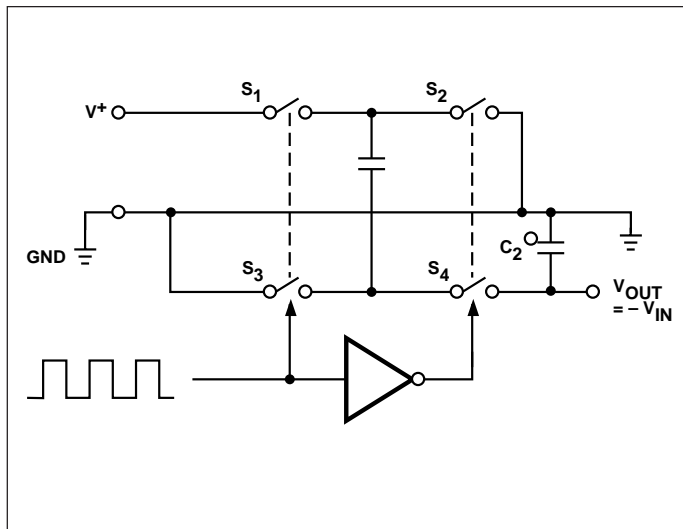

Figure 2. Idealized Charge Pump Inverter

To improve low-voltage operation, the LV pin should be connected to GND. For supply voltages greater than 3.5V, the LV terminal **must be left open to ensure latch-up-proof operation and prevent device damage.**

Theoretical Power Efficiency Considerations

In theory, a capacitive charge pump can approach 100% efficiency if certain conditions are met:

- (1) The drive circuitry consumes minimal power.
- (2) The output switches have extremely low ON resistance and virtually no offset.
- (3) The impedances of the pump and reservoir capacitors are negligible at the pump frequency.

The TC7660H approaches these conditions for negative voltage multiplication if large values of C₁ and C₂ are used. **Energy is lost only in the transfer of charge between capacitors if a change in voltage occurs.** The energy lost is defined by:

$$E = 1/2 C_1 (V_1^2 - V_2^2)$$

V₁ and V₂ are the voltages on C₁ during the pump and transfer cycles. If the impedances of C₁ and C₂ are relatively high at the pump frequency (refer to Figure 1), compared to the value of R_L, there will be a substantial difference in voltages V₁ and V₂. Therefore, it is not only desirable to make C₂ as large as possible to eliminate output voltage ripple, but also to employ a correspondingly large value for C₁ in order to achieve maximum efficiency of operation.

Do's and Don'ts

- Do not exceed maximum supply voltages.
- Do not connect LV terminal to GND for supply voltages greater than 3.5V.
- Do not short circuit the output to V⁺ supply for voltages above 5.5V for extended periods; however, transient conditions including start-up are okay.
- When using polarized capacitors in the inverting mode, the + terminal of C₁ must be connected to pin 2 of the TC7660H and the + terminal of C₂ must be connected to GND Pin 3.

HIGH FREQUENCY 7660 DC-TO-DC VOLTAGE CONVERTER

TC7660H

Simple Negative Voltage Converter

Figure 3 shows typical connections to provide a negative supply where a positive supply is available. A similar scheme may be employed for supply voltages anywhere in the operating range of +1.5V to +10V, keeping in mind that pin 6 (LV) is tied to the supply negative (GND) only for supply voltages below 3.5V.

The output characteristics of the circuit in Figure 3 are those of a nearly ideal voltage source in series with 70Ω. Thus, for a load current of -10 mA and a supply voltage of +5V, the output voltage would be -4.3V.

The dynamic output impedance of the TC7660H is due, primarily, to capacitive reactance of the charge transfer capacitor (C₁). Since this capacitor is connected to the output for only 1/2 of the cycle, the equation is:

$$X_C = \frac{2}{2\pi f C_1} = 2.12\Omega,$$

where $f = 150\text{kHz}$ and $C_1 = 1.0\mu\text{F}$.

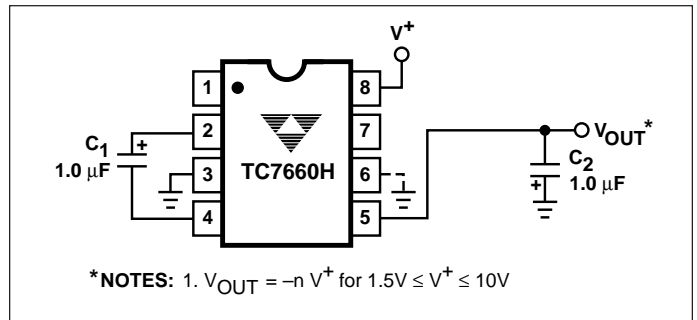

Figure 3. Simple Negative Converter

Paralleling Devices

Any number of TC7660H voltage converters may be paralleled to reduce output resistance (Figure 4). The reservoir capacitor, C₂, serves all devices, while each device requires its own pump capacitor, C₁. The resultant output resistance would be approximately:

$$R_{OUT} = \frac{R_{OUT} \text{ (of TC7660H)}}{n \text{ (number of devices)}}$$

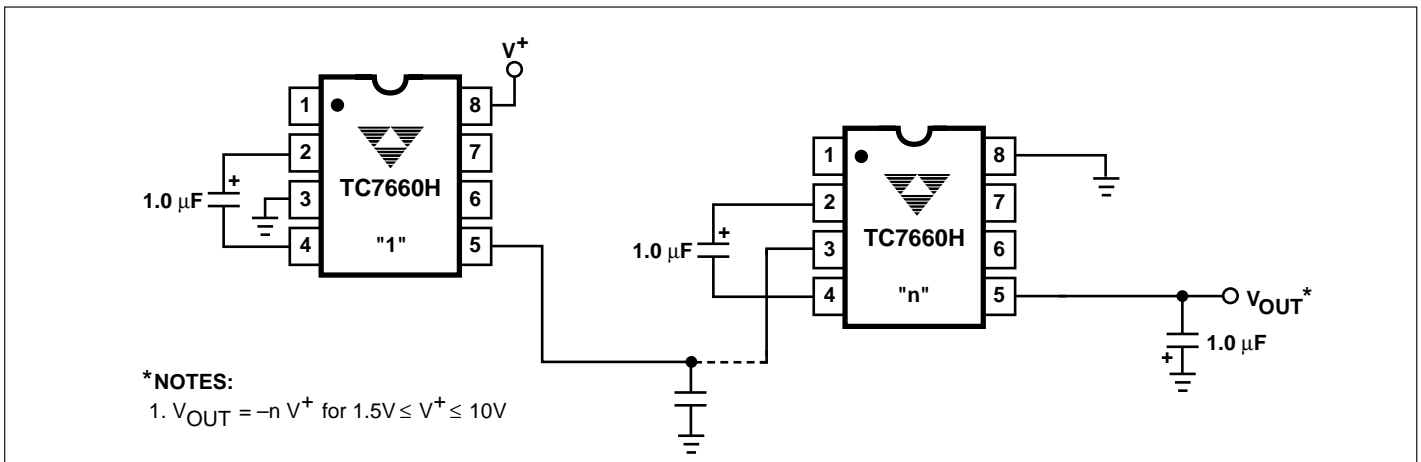

Figure 4. Increased Output Voltage by Cascading Devices

Cascading Devices

The TC7660H may be cascaded as shown in (Figure 4) to produce larger negative multiplication of the initial supply voltage. However, due to the finite efficiency of each device, the practical limit is probably 10 devices for light loads. The output voltage is defined by:

$$V_{OUT} = -n (V_{IN})$$

where n is an integer representing the number of devices cascaded. The resulting output resistance would be approximately the weighted sum of the individual TC7660H R_{OUT} values.

Changing the TC7660H Oscillator Frequency

It may be desirable in some applications (due to noise or other considerations) to increase or decrease the oscillator frequency. This can be achieved by overdriving the oscillator from an external clock, as shown in Figure 6. In order to prevent possible device latch-up, a 1kΩ resistor must be used in series with the clock output. In a situation where the designer has generated the external clock frequency using TTL logic, the addition of a 10kΩ pull-up resistor to V⁺ supply is required. Note that the pump frequency with external clocking, as with internal clocking, will be 1/2 of the clock frequency. Output transitions occur on the positive-going edge of the clock.

HIGH FREQUENCY 7660 DC-TO-DC VOLTAGE CONVERTER

TC7660H

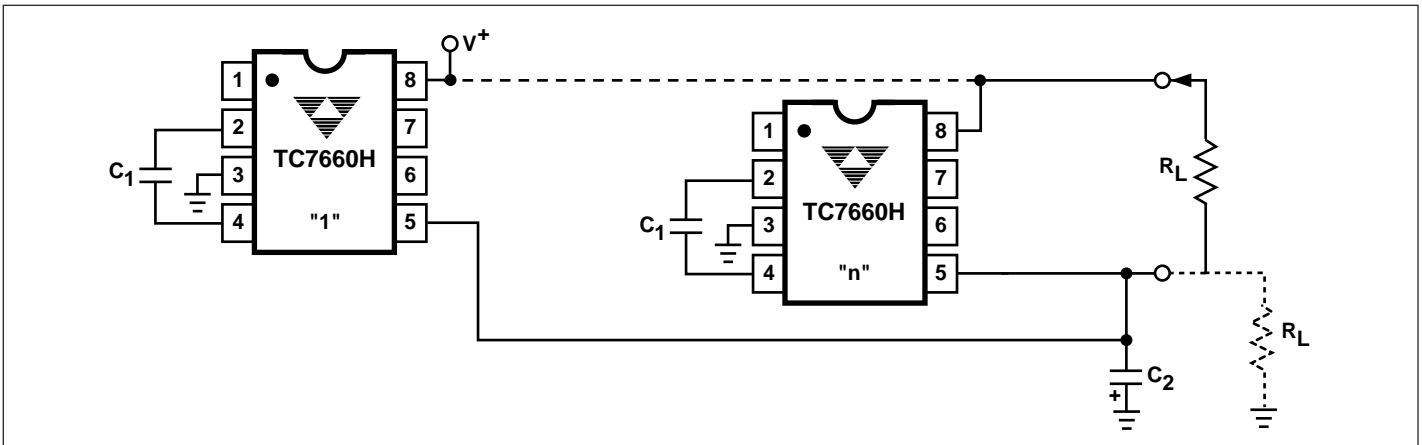

Figure 5. Paralleling Devices Lowers Output Impedance

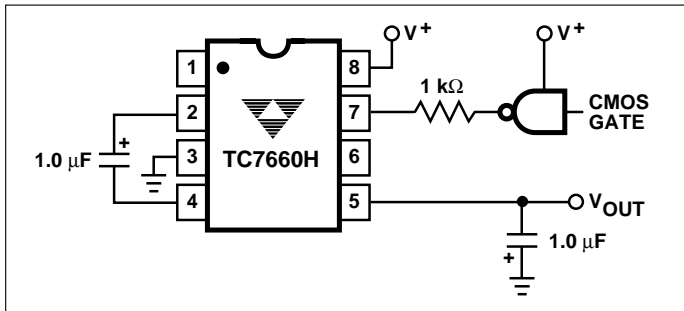

Figure 6. External Clocking

Positive Voltage Multiplication

The TC7660H may be employed to achieve positive voltage multiplication using the circuit shown in Figure 7. In this application, the pump inverter switches of the TC7660H are used to charge C_1 to a voltage level of $V^+ - V_F$ (where V^+ is the supply voltage and V_F is the forward voltage drop of diode D_1). On the transfer cycle, the voltage on C_1 plus the supply voltage (V^+) is applied through diode D_2 to capacitor C_2 . The voltage thus created on C_2 becomes $(2V^+) - (2V_F)$, or twice the supply voltage minus the combined forward voltage drops of diodes D_1 and D_2 .

The source impedance of the output (V_{OUT}) will depend on the output current, but for $V^+ = 5V$ and an output current of 10mA, it will be approximately 60Ω.

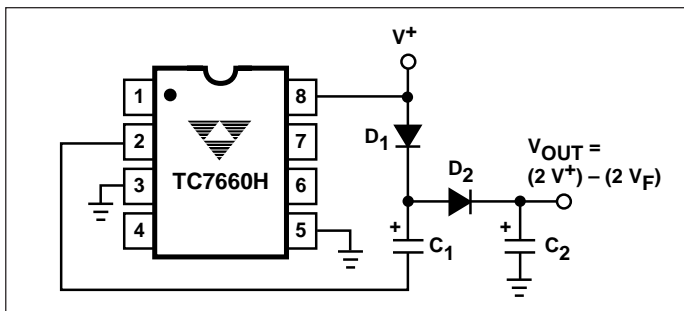

Figure 7. Positive Voltage Multiplier

Combined Negative Voltage Conversion and Positive Supply Multiplication

Figure 8 combines the functions shown in Figures 3 and 8 to provide negative voltage conversion and positive voltage multiplication simultaneously. This approach would be, for example, suitable for generating +9V and -5V from an existing +5V supply. In this instance, capacitors C_1 and C_3 perform the pump and reservoir functions, respectively, for the generation of the negative voltage, while capacitors C_2 and C_4 are pump and reservoir, respectively, for the multiplied positive voltage. There is a penalty in this configuration which combines both functions, however, in that the source impedances of the generated supplies will be somewhat higher due to the finite impedance of the common charge pump driver at pin 2 of the device.

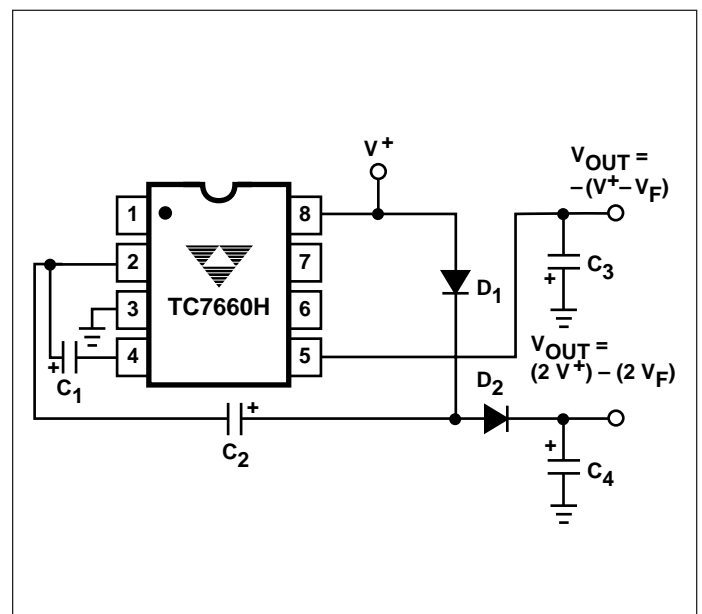

Figure 8. Combined Negative Converter and Positive Multiplier

HIGH FREQUENCY 7660 DC-TO-DC VOLTAGE CONVERTER

TC7660H

Efficient Positive Voltage Multiplication/Conversion

Since the switches that allow the charge pumping operation are bidirectional, the charge transfer can be performed backwards as easily as forwards. Figure 9 shows a TC7660H transforming $-5V$ to $+5V$ (or $+5V$ to $+10V$, etc.). The only problem here is that the internal clock and switch-drive section will not operate until some positive voltage has been generated. An initial inefficient pump, as shown in Figure 9, could be used to start this circuit up, after which it will bypass the diode and resistor shown dotted in Figure 9.

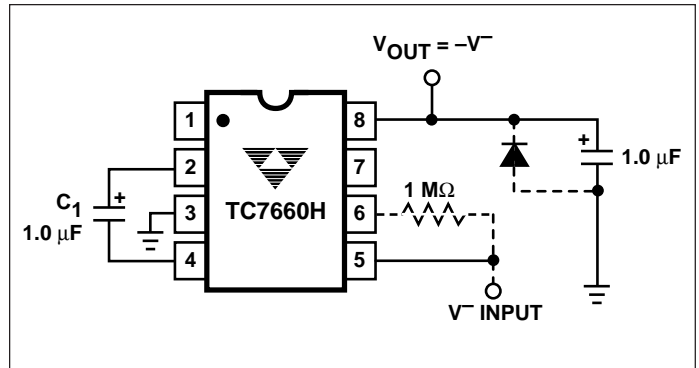
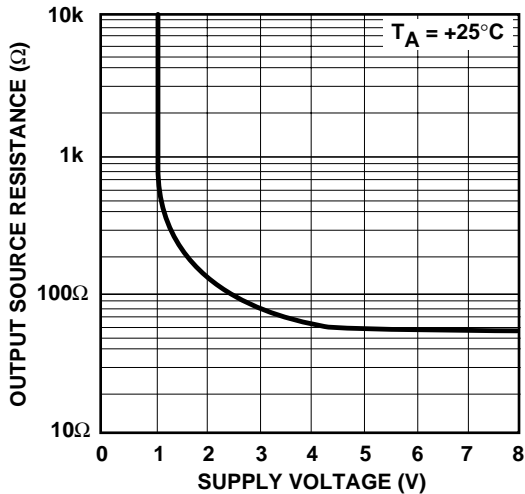

Figure 9. Positive Voltage Conversion

TYPICAL PERFORMANCE CHARACTERISTICS (Circuit of Figure 1)

Output Source Resistance vs. Supply Voltage



Output Source Resistance vs. Temperature

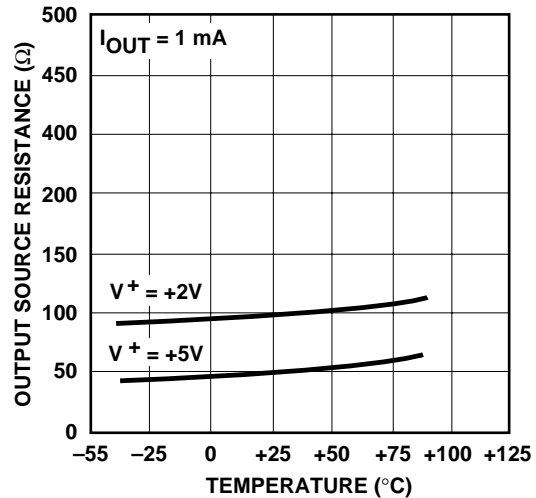

Output Voltage vs. Output Current

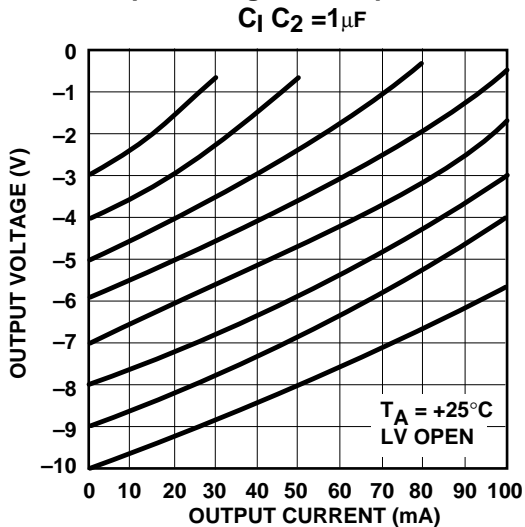

Output Voltage vs. Load Current

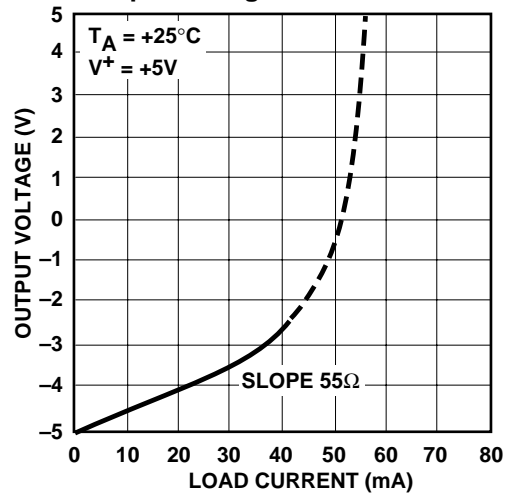

HIGH FREQUENCY 7660 DC-TO-DC VOLTAGE CONVERTER

TC7660H

PACKAGE DIMENSIONS

8-Pin Plastic DIP

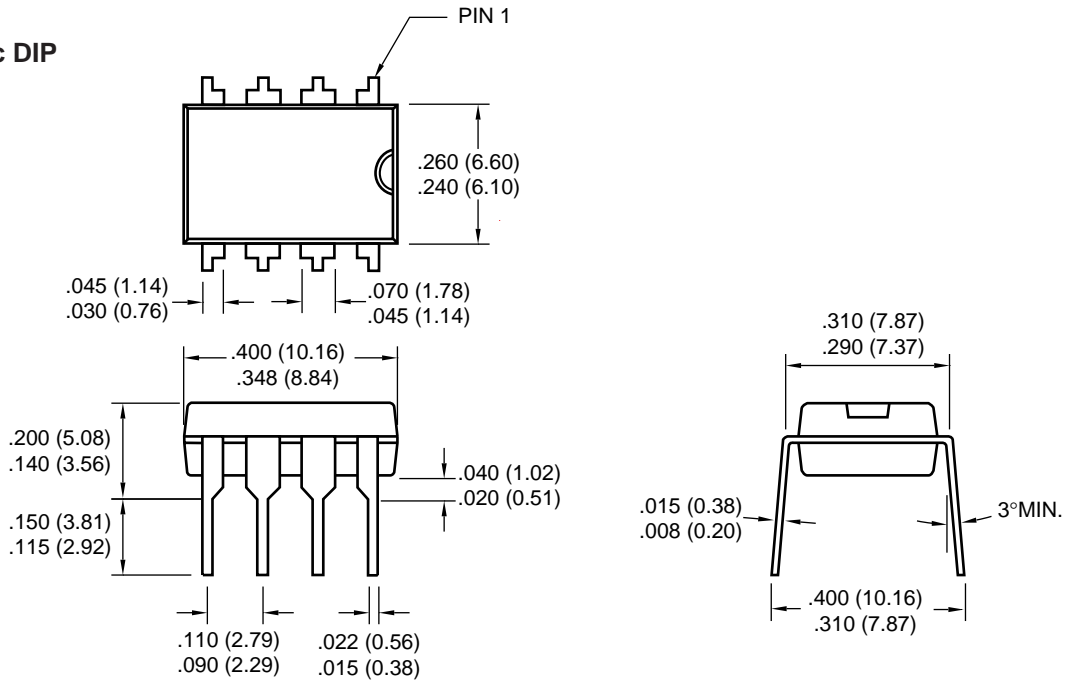

8-Pin SOIC

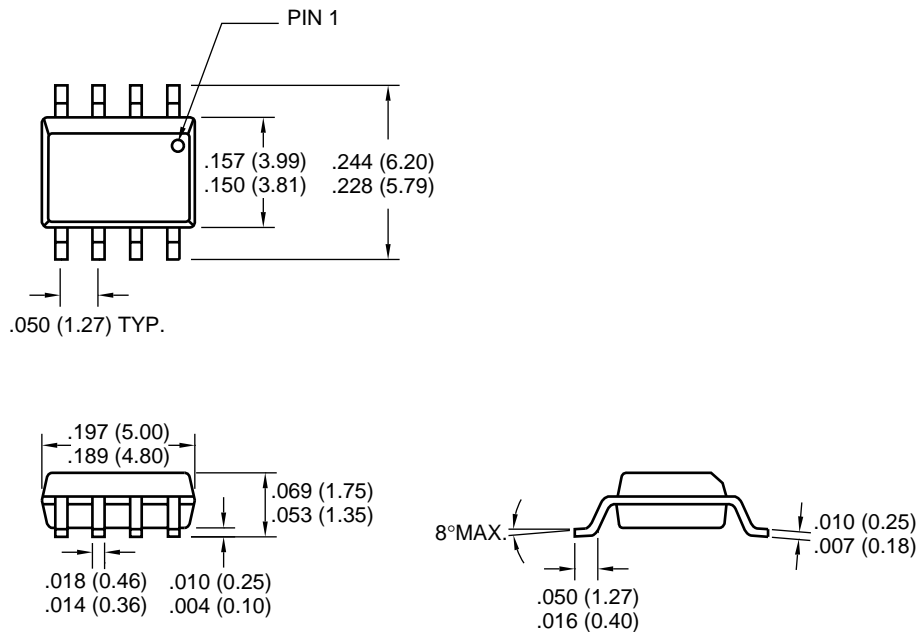

Dimensions: inches (mm)

Sales Offices

TelCom Semiconductor
1300 Terra Bella Avenue
P.O. Box 7267
Mountain View, CA 94039-7267
TEL: 415-968-9241
FAX: 415-967-1590
E-Mail: liter@c2smtp.telcom-semi.com

TelCom Semiconductor
Austin Product Center
9101 Burnet Rd. Suite 214
Austin, TX 78758
TEL: 512-873-7100
FAX: 512-873-8236

TelCom Semiconductor H.K. Ltd.
10 Sam Chuk Street, Ground Floor
San Po Kong, Kowloon
Hong Kong
TEL: 852-2324-0122
FAX: 852-2354-9957