



TRIO

# SERVICE MANUAL

## JR-310



# PARTS DESCRIPTION LIST

■ MAIN CHASSIS (LC1JM) SECTION				
PRINTED CIRCUIT				
-	VFO	Block	UC0116J1	
-	IF	Block	UC1210J	
-	BFO	Block	UC1211J	
-	AF	Block	UC1306J	
-	RF	Block	UC1117J	
Symbol No.	Description		Part No.	Remarks
CAPACITORS				
C2	Ceramic		0.001 $\mu$ F +100% -0%	
C3	Electrolytic Tubular		10 $\mu$ F 15WV	
C4	Ceramic		0.01 $\mu$ F +100% -0%	
C5	Ceramic		0.05 $\mu$ F +100% -0%	
C6~10	Ceramic		0.01 $\mu$ F +100% -0%	
C11~13	Electrolytic Block		40 $\mu$ F 350WV	
C14	Electrolytic Tubular		20 $\mu$ F 350WV	
RESISTORS				
R1, 2	Fixed Carbon Composition		1k $\Omega$ $\pm$ 10% 1/2W	
R3	Fixed Carbon Composition		3.3k $\Omega$ $\pm$ 10% 1/2W	
R4	Metallic Oxide Film		1k $\Omega$ $\pm$ 10% 8W	
R5	Resin Coated		2.2k $\Omega$ $\pm$ 5% 8W	
R6	Metallic Oxide Film		22k $\Omega$ $\pm$ 10% 3W	
R7	Fixed Carbon Composition		82 $\Omega$ $\pm$ 10% 1/2W	
R9	Metallic Oxide Film		4.7k $\Omega$ $\pm$ 5% 8W	
R11	Fixed Carbon Composition		1.8k $\Omega$ $\pm$ 10% 1/2W	
POTENTIOMETERS				
VR1	5k $\Omega$ (B)	RF GAIN		R01-1130
VR2	10k $\Omega$	RIT ADJ.		R10-59
VR3	5k $\Omega$ (B)	RIT VR		R01-1102
VR4	500 $\Omega$ (B)	S-ADJ.		R01-0155
VR5	500k $\Omega$ (A)	AF GAIN		R01-1102
SWITCHES				
S1	Selectivity (Rotary)	M.1.4.3		S04-141
S2	Function (Rotary)	Y.2.4.6		S03-681
S3	Power Switch (Push)			S11-22
S4	Line Switch (Slide)			S10-22R
DIODES/THERMISTOR				
D1	SZ-200-9			
D2, 3	SW-05-(Gray)			
D4	1N60			
TH1	5T-31			
MISCELLANEOUS				
-	Case			A01-LB0J
-	Chassis			A03-LC1JM
-	Panel Framework			A20-1052-03
-	Panel			A20-0153-03
-	Sole Plate			A08-LC1J
-	Decorated Board			A67-12
-	Spring			A62-12

## PARTS DESCRIPTION LIST

Symbol No.	Description	Part No.	Remarks
—	Bronzed Stick	A64-45	
—	Bronzed Pipe	A64-44	
—	Ammeter Holder (A)	A5053	
—	Ammeter Holder (B)	A5054	
—	Switch Holder	A5059	
—	Side Escutcheon	B01-0005-04	
—	A Certificate	B42-0009-04	
—	Pulley	D04-29	
—	U.S. Socket	E01-38A	
—	P.L. Holder x 2	E02-02F	
—	Lug	E04-101	
—	Terminal Block	E06-12J	
—	Terminal Block	E06-13C	
—	U.S. Plug	E09-580	
—	9P Plug	E09-890	
—	U.S. Juck	E16-09	
—	Beaded Band	E4099	
—	Rubber Band	G03-46	
—	Leg x 4	G10-02	
—	Leg x 2	G10-08	
—	Cord Bushing	G11-01	
—	Corrugated Cardboard Case	H01-0098-03	
—	Polyethylene Cover	H02-122	
—	Instruction Manual	H05-LC1JM	
—	Polyethylene Bag (for Accessory)	H08-04B	
—	Accessory of Corrugated Cardboard Case	H09-LB0JA	
—	Accessory of Corrugated Cardboard Case	H09-LB0JB	
—	Name Plate (for Adjustment)	H29-LC1J	
—	Instructions (for AC Power Supply)	H4190	
—	Instructions	H4191	
—	Knob	K21-0001-04	
—	Trap Coil	H13-159	
—	Decorative Screw (4φ) x 4	N11-41	
—	Colored Pipe	N13-510	
—	Thumb Screw	N4006	
—	Shaft Stopper	N4104	
—	Bearing	N4105	
—	Knob x 2	S14-275	
—	Knob	S14-332	
—	Knob x 2	S14-333	
—	Knob	S14-441	
—	Knob	S14-627	
—	Fuse Holder	S15-03B	
P.L.	Pilot Lamp x 2	S16-22	
F	Fuse (2A)	S17-02	
—	Acryl Board	S20-42	
—	Flange Knob	S4135	
—	Switch Stopper	S4103	
P.T.	Power Transformer	T04-222W	
M	S-Meter	T11-94	
—	Stranded Wire Yellow 0.2m	W01-34	
—	P.V.C. Insulated Wire (red 0.8φ) 0.2m	W02-82	

# PARTS DESCRIPTION LIST

Symbol No.	Description	Part No.	Remarks
—	P.V.C. Insulated Wire (blue 0.8φ) 0.6m	W02-86	
—	P.V.C. Insulated Wire (white 0.8φ) 1m	W02-89	
—	P.V.C. Insulated Wire (black 0.5φ) 0.8m	W02-50	
—	P.V.C. Insulated Wire (red 0.5φ) 3.5m	W02-52	
—	P.V.C. Insulated Wire (yellow 0.5φ) 2m	W02-54	
—	P.V.C. Insulated Wire (blue 0.5φ) 1.8m	W02-56	
—	P.V.C. Insulated Wire (white 0.5φ) 2.3m	W02-59	
—	Tinned Wire 0.8φ 1.1m	W03-08	
—	Tinned Wire 1.2φ 2.5m	W03-12	
—	Insulating Sleeve 1.2m	W06-154	
—	AC Cord	W09-01	
—	Single-Core Shielded Wire 2.5m	W11-010B	
—	Single-Core Shielded Wire 2.5m	W11-012	
—	Double-Core Shielded Wire 0.45m	W51-020	
—	Reticular Wire 0.03m	W14-01	
—	Decorative Screw (⊕ MH3 x 6 - F.B) x 3		
—	Screw (M6 x 18 - F)		
—	Washer (Special W6 x 13 x 1 - F) x 2		
—	Nut (N6 - F)		
—	Spring Washer (SW6 - S)		
—	Pan Head Screw (⊕ P3 x 4 - F) x 25		
—	Pan Head Screw (⊕ P3 x 6 - F) x 40		
—	Tapping Screw (⊕ TM3 x 6 - F) x 75		
—	Tapping Screw (⊕ TS3 x 6 - F) x 2		
—	Nut (N3 - F) x 10		
—	Nut (N32.6 - B)		
—	Flat Head Washer (W3 - F) x 6		
—	Spring Washer (SW2.6 - S)		
—	Nut (N3 - F - ISO) x 4		
<b>■ UC1117J</b>			
<b>CAPACITORS</b>			
C1~8	Ceramic	0.01μF +100%, -0%	
C9	Ceramic	100pF ±10%	
C10	Ceramic	0.01μF +100%, -0%	
C11	Ceramic	2pF ±0.5pF	
C12~14	Ceramic	0.01μF +100%, -0%	
C15~17	Ceramic	100pF ±10%	
C18	Ceramic	0.002μF ±20%	
C19	Ceramic	0.01μF +100%, -0%	
C20	FM Capacitor	82pF ±10%	
C21~24	Ceramic	0.01μF +100%, -0%	
—	Variable Capacitor		D01-167
—	Variable Capacitor		D01-168
—	Trimmer		C09-40E
—	Trimmer		C4047
<b>RESISTORS</b>			
R3	Fixed Carbon Composition	1MΩ ±10% 1/2W	
R4	Fixed Carbon Composition	33Ω ±10% 1/2W	
R5	Fixed Carbon Composition	220Ω ±10% 1/2W	
R6	Fixed Carbon Composition	1kΩ ±10% 1/2W	
R7	Fixed Carbon Composition	3.3kΩ ±10% 1/2W	

## PARTS DESCRIPTION LIST

Symbol No.	Description	Part No.	Remarks
R8	Fixed Carbon Composition 10Ω ±10% 1/2W		
R9	Fixed Carbon Composition 1MΩ ±10% 1/2W		
R10	Fixed Carbon Composition 330Ω ±10% 1/2W		
R11	Fixed Carbon Composition 470kΩ ±10% 1/2W		
R12	Fixed Carbon Composition 1kΩ ±10% 1/2W		
R13	Fixed Carbon Composition 47kΩ ±10% 1/2W		
R14	Fixed Carbon Composition 1MΩ ±10% 1/2W		
R15	Fixed Carbon Composition 3.9kΩ ±10% 1/2W		
R16, 17	Fixed Carbon Composition 1kΩ ±10% 1/2W		
R18	Fixed Carbon Composition 8.2kΩ ±10% 1/2W		
R19	Fixed Carbon Composition 68kΩ ±10% 1/2W		
<b>COILS/QUARTZ-OSCILLATORS</b>			
X1	35.055 MHz	L77-0001-05	
X2	34.455 MHz	T13-112	
X3	33.955 MHz	T13-111	
X4	26.955 MHz	T13-110	
X5	19.955 MHz	T13-109	
X6	12.955 MHz	T13-108	
X7	9.455 MHz	T13-107	
—	Coil Pack	L60-0001-02	
L7	OSC Coil	L11-93	
L6	OSC Coil	L11-94	
L5	OSC Coil	L11-95	
L4	OSC Coil	L11-96	
L3, 8	OSC Coil	L11-97	
IFT1	IFT	L01-91	
L11	Trap Coil	L13-155	
—	Ferri-Inductor FL5H-102J		
<b>TUBES</b>			
V1	6BZ6		
V2	6BL8		
V3	6CB6		
<b>MISCELLANEOUS</b>			
—	Sub-Chassis	A04-UC1117J	
—	V.C. Cover	A90-UC1117J	
—	V.C. Holder (A)	A5053	
—	V.C. Holder (B)	A5054	
—	7P Molded Socket x 2	E01-17A	
—	9P Molded Socket x 2	E01-19A	
—	Lug x 4	E04-101B	
—	Lug x 3	E04-202	
—	Lug x 5	E04-202B	
—	Shield Case	E24-01	
—	Shield Case Washer	E24-02	
—	Shield Case	E24-06	
—	Shield Case Washer	E24-07	
—	Rubber Cushion x 2	G13-0002-04	
<b>■ UC0116J<sub>1</sub></b>			
<b>CAPACITORS</b>			
C1	Temperature Compensating Ceramic 47pF ±5%		

# PARTS DESCRIPTION LIST

Symbol No.	Description	Part No.	Remarks
C2, 3	Temperature Compensating Ceramic 150pF ±5%		
C4	Temperature Compensating Ceramic 70pF ±5%		
C5	Temperature Compensating Ceramic 470pF ±5%		
C6	Temperature Compensating Ceramic 220pF ±5%		
C7, 8	Super Mica 1500pF		
C9	Hi Q Mica 3pF ±0.5pF		
C10	Ceramic 0.02μF +80%, -20%		
C11, 12	Cermiac 0.04μF +80%, -20%		
C13	Ceramic 0.02μF +80%, -20%		
C14	Ceramic 33pF ±0.5%		
C15	Ceramic 5pF ±0.5pF		
C16	Ceramic 10pF ±0.5pF		
C17	Ceramic 5pF ±0.5pF		
C18	Ceramic 0.01μF +80%, -20%		
C20	Temperature Compensating Ceramic (CC94CG1H100J)		
<b>RESISTORS</b>			
R1	Fixed Carbon Composition 270kΩ ±5% 1/4W		
R2	Fixed Carbon Composition 100Ω ±5% 1/4W		
R3, 4	Fixed Carbon Composition 1MΩ ±5% 1/4W		
R5	Fixed Carbon Composition 330Ω ±5% 1/4W		
R6	Fixed Carbon Composition 33kΩ ±5% 1/4W		
R7	Fixed Carbon Composition 47kΩ ±5% 1/4W		
R8	Fixed Carbon Composition 1kΩ ±5% 1/4W		
R9	Fixed Carbon Composition 100Ω ±5% 1/4W		
<b>COILS</b>			
L2~4	Ferrite Inductor (FL5H-102K)		
L5	Ferrite Inductor (FL5H-220K)		
L6~7	Ferrite Inductor (FL5H-102K)		
L	OSC Coil	L11-78	
<b>TRANSISTORS/DIODES</b>			
Q1	3SK22 (Y)		
Q2	2SK19 (Y)		
Q3, 4	2SC460 (B)		
D1	SD111		
D2, 3	1N60		
<b>MISCELLANEOUS</b>			
-	Printed Circuit Board	J25-0019-04	
-	Dial Scale	A07-UC0110J	
-	Name Plate	B42-0010-04	
V.C.	Variable Capacitor	C01-0001-05	
V.C.	Midget Capacitor	C03-0001-05	
-	Trimmer (ECV-1ZW 10P12)	C4036	
-	Dial	C4036	
-	V.F.O. Box (A)	F11-0004-13	
-	V.F.O. Box (B)	F11-0005-04	
-	V.F.O. Box (C)	F11-0006-03	
-	V.F.O. Box (D)	F11-0007-04	
-	V.F.O. Box (E)	F11-0008-04	
-	V.F.O. Box (F)	F11-0013-04	
-	V.F.O. Box (G)	F11-0010-04	

# PARTS DESCRIPTION LIST

Symbol No.	Description	Part No.	Remarks
—	V.F.O. Box (H)	F11-0011-04	
—	V.F.O. Box (I)	F11-0012-04	
—	Lug	E04-101B	
—	Acme Terminal	E4071	
—	Terminal x 5	N4085	
—	Earth Lug	N28-0.32	
—	Shaft Coupling	S4082	
—	P.V.C. Insulated Wire 0.5/s. 0.3m	W02-50	
—	P.V.C. Insulated Wire 0.2m	W02-52	
—	P.V.C. Insulated Wire 0.3m	W02-54	
—	P.V.C. Insulated Wire 0.2m	W02-56	
—	Tinned Wire 0.8/s. TCW 0.2m	W03-08	
—	Pan Head Screw (⊕P2 x 4-F) x 3		
—	Pan Head Screw (⊕P3 x 6-F) x 38		
—	Flat Head Washer (W3-F) x 4		
—	Pan Head Screw (⊕P3 x 4-F)		
<b>■ UC1210J</b>			
<b>CAPACITORS</b>			
C1	Ceramic 0.01μF +100%, -0%		
C2	Polystyrene Film 470pF ±5%		
C3	Ceramic 0.01μF +100%, -0%		
C5~13	Ceramic 0.01μF +100%, -0%		
C14	MP Capacitor 0.5μF ±20%		
C15~17	Ceramic 0.01μF ±100%, -0%		
C18	Ceramic 0.1μF		
C19	Ceramic 2pF ±5pF		
C20	Ceramic 100pF ±10%		
C21	Ceramic 0.01μF +100%, -0%		
C22	MP Capacitor 0.1μF ±20%		
C23~25	Ceramic 0.01μF +100%, -0%		
C26	Ceramic 0.001μF +100%, -0%		
<b>RESISTORS</b>			
R1, 2	Fixed Carbon Composition 10kΩ ±10% 1/2W		
R3	Fixed Carbon Composition 100kΩ ±10% 1/2W		
R4	Fixed Carbon Composition 220Ω ±10% 1/2W		
R5	Fixed Carbon Composition 22kΩ ±10% 1/2W		
R6	Fixed Carbon Composition 1kΩ ±10% 1/2W		
R7	Fixed Carbon Composition 2.2MΩ ±10% 1/2W		
R8	Fixed Carbon Composition 100kΩ ±10% 1/2W		
R10	Fixed Carbon Composition 22kΩ ±10% 1/2W		
R11	Fixed Carbon Composition 1kΩ ±10% 1/2W		
R12, 13	Fixed Carbon Composition 470Ω ±10% 1/2W		
R14~17	Fixed Carbon Composition 330Ω ±10% 1/4W		
R18	Fixed Carbon Composition 1MΩ ±10% 1/2W		
R19, 20	Fixed Carbon Composition 470kΩ ±10% 1/2W		
<b>TUBE/DIODES</b>			
V1, 2	6BA6		
D1~12	1N60		
<b>MISCELLANEOUS</b>			
—	Printed Circuit Board	S23-304	

## PARTS DESCRIPTION LIST

Symbol No.	Description	Part No.	Remarks
—	Ferri-Inductor FL-5H102J		
—	Ferri-Inductor FL-10H563J		
—	IFT	L01-66	
—	IFT	L01-92	
—	Ceramic Filter	L4016	
—	Matching Transformer	L51-19	
—	Shielding Case	E24-06	
—	7P Socket (for Printed Circuit Board)	E51-71A	
—	Terminal (for Printed Circuit Board) x 13	N4085	
—	P.V.C. Insulated Wire (yellow 0.5φ) 0.2m	W02-54	
—	P.V.C. Insulated Wire (blue 0.5φ) 0.2m	W02-56	
—	Tinned Wire 0.8φ 0.1m	W03-08	
<b>■ UC1211J</b>			
<b>CAPACITORS</b>			
C1	Polystyrene Film Capacitor 1000pF ±5%		
C2, 3	Ceramic 0.04μF +80%, -20%		
<b>RESISTORS</b>			
R1	Fixed Carbon Composition 47kΩ ±10% 1/4W		
R2	Fixed Carbon Composition 3.3kΩ ±10% 1/4W		
R3	Fixed Carbon Composition 1.5kΩ ±10% 1/4W		
<b>TRANSISTOR/QUARTZ-OSCILLATORS</b>			
Q1	2SC 373		
X1	453.5kHz	T13-113	
X2	456.5kHz	T13-114	
<b>MISCELLANEOUS</b>			
—	Printed Circuit Board	S23-306	
T	Output Transformer	T02-65	
—	Terminal (for Printed Circuit Board) x 7	N4085	
<b>■ UC1306J</b>			
<b>CAPACITORS</b>			
C1, 2	Ceramic 0.01μF +100%, -0%		
C3	Electrolytic Tubular 10μF 16WV		
C4	Electrolytic Tubular 10μF 350WV		
C5	Electrolytic Tubular 100μF 25WV		
C6	Electrolytic Tubular 10μF 350WV		
C7	Oil Impregnated Paper 0.005μF		
C9	Ceramic 0.001μF		
<b>RESISTORS</b>			
R1	Fixed Carbon Composition 470kΩ ±10% 1/2W		
R2	Fixed Carbon Composition 1kΩ ±10% 1/2W		
R3	Fixed Carbon Composition 100kΩ ±10% 1/2W		
R4	Fixed Carbon Composition 470kΩ ±10% 1/2W		
R5	Fixed Carbon Composition 330Ω ±10% 2W		
R6	Fixed Carbon Composition 1kΩ ±10% 1/2W		
R7	Fixed Carbon Composition 3.3kΩ ±10% 1/2W		
<b>TUBE</b>			
V1	6BM8		



# PARTS DESCRIPTION LIST

Symbol No.	Description	Part No.	Remarks
<b>MISCELLANEOUS</b>			
—	Printed Circuit Board	S23-305	
—	Output Transformer	T02-64	
—	9P Socket (for Printed Circuit Board)	E51-91B	
—	Terminal (for Printed Circuit Board) x 7		

# CHASSIS TOP VIEW

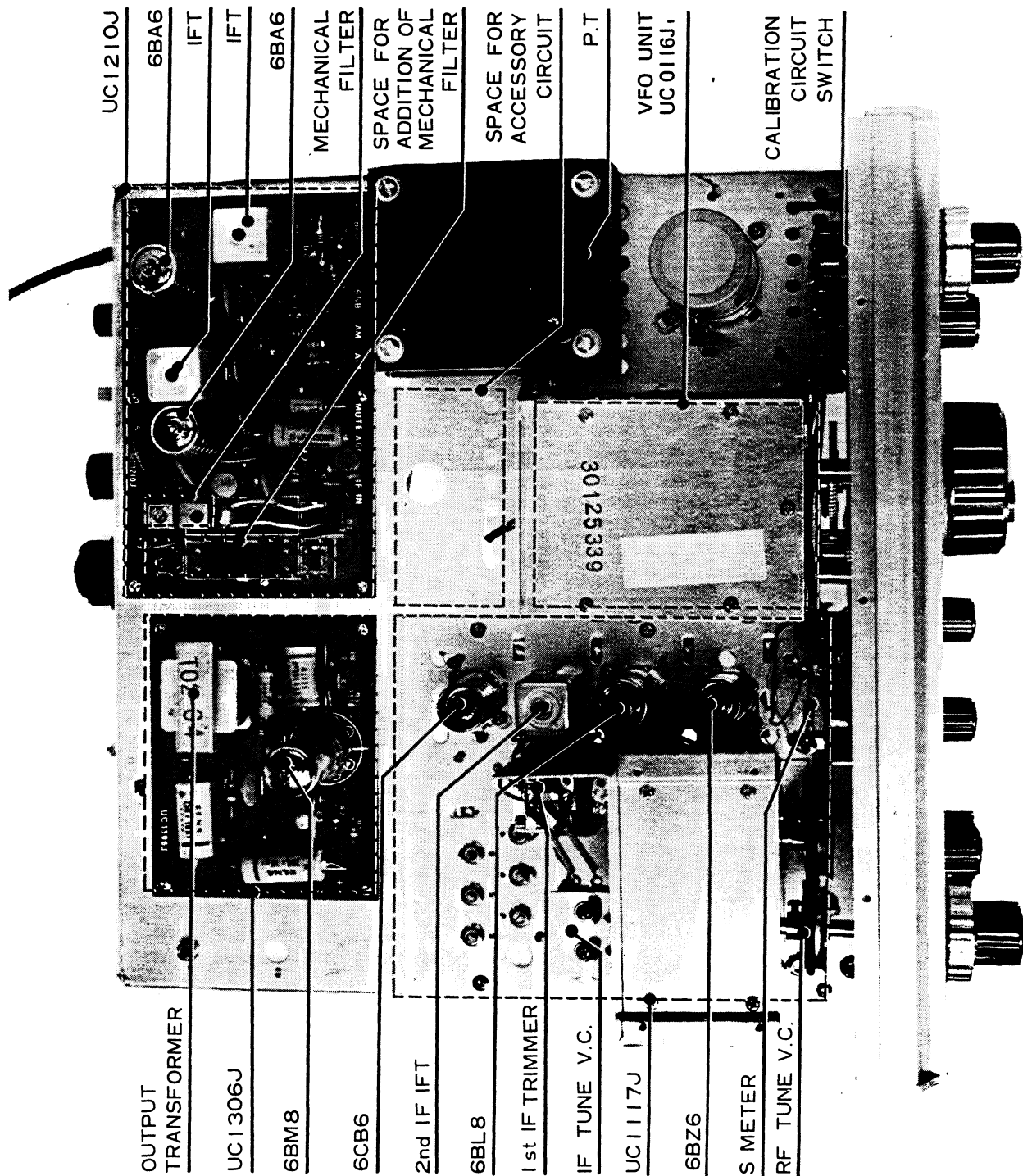

# CHASSIS BOTTOM VIEW

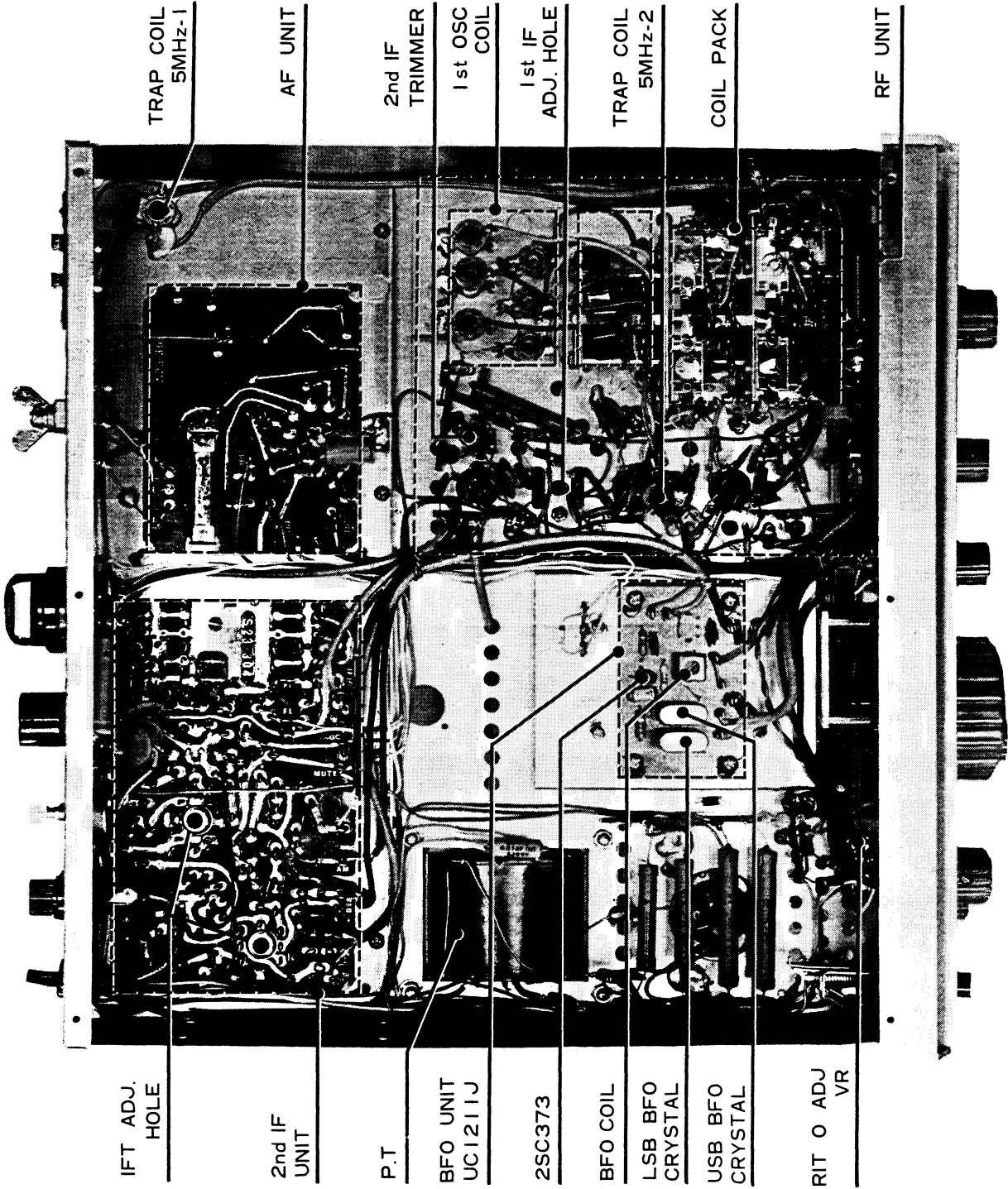

IFT ADJ.  
HOLE

2nd IF  
UNIT

P.T

BFO UNIT  
UC1211J

25C373

BFO COIL

LSB BFO  
CRYSTAL

USB BFO  
CRYSTAL

RIT O ADJ  
VR

TRAP COIL  
5MHz-1

AF UNIT

2nd IF  
TRIMMER

1st OSC  
COIL

1st IF  
ADJ. HOLE

TRAP COIL  
5MHz-2

COIL PACK

RF UNIT

# BLOCK DIAGRAM

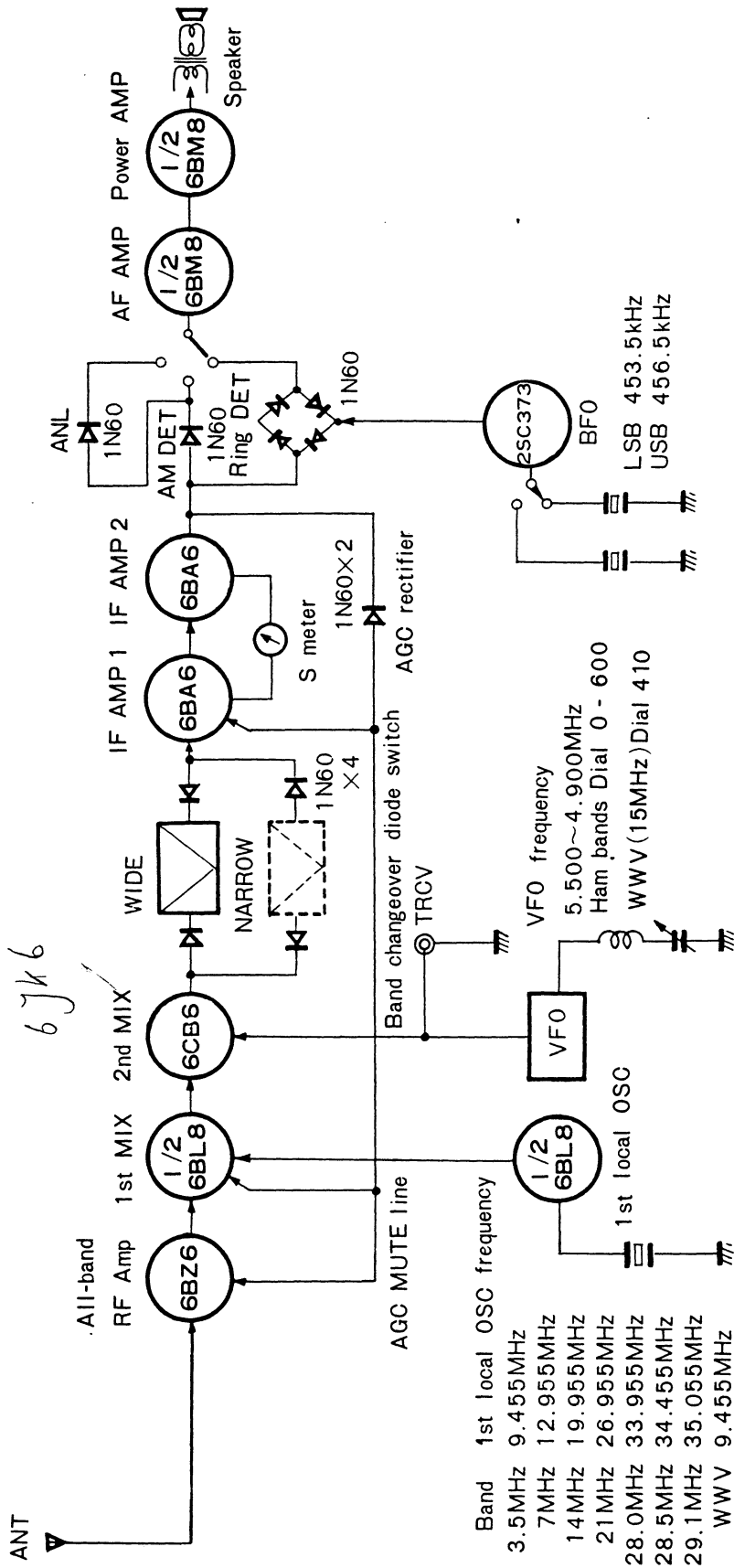

**SEALED CIRCUIT ASSEMBLIES-PHANTOM VIEWS**

UC0116J1 - VFO

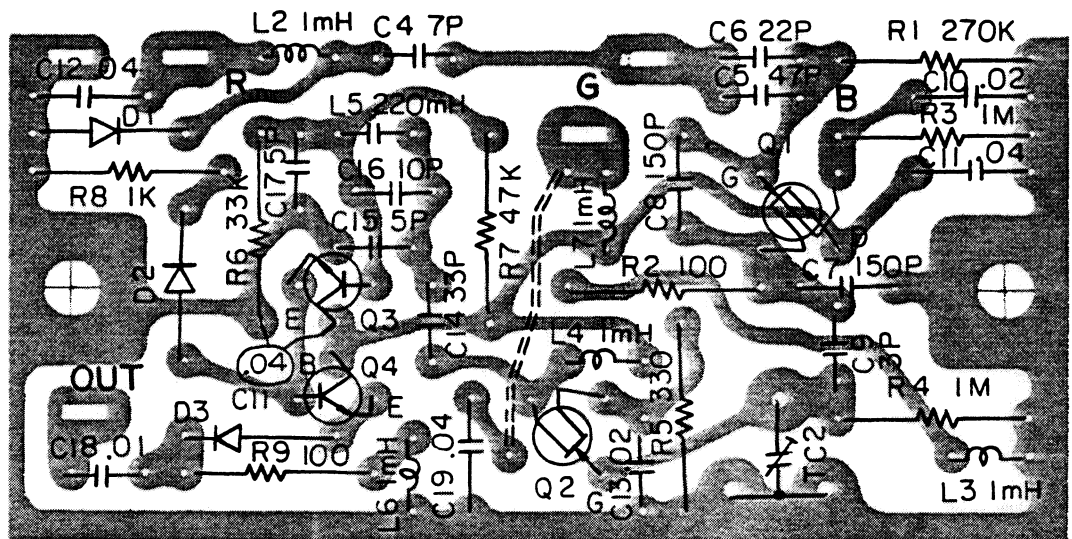

Q1 3SK22(Y), Q2 2SK19(Y), Q3,4 2SC460(B), D SDIII, D2,3 IN60

3SK22(Y)



2SK19Y



2SC460(B)

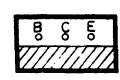

UC1211J - BFC

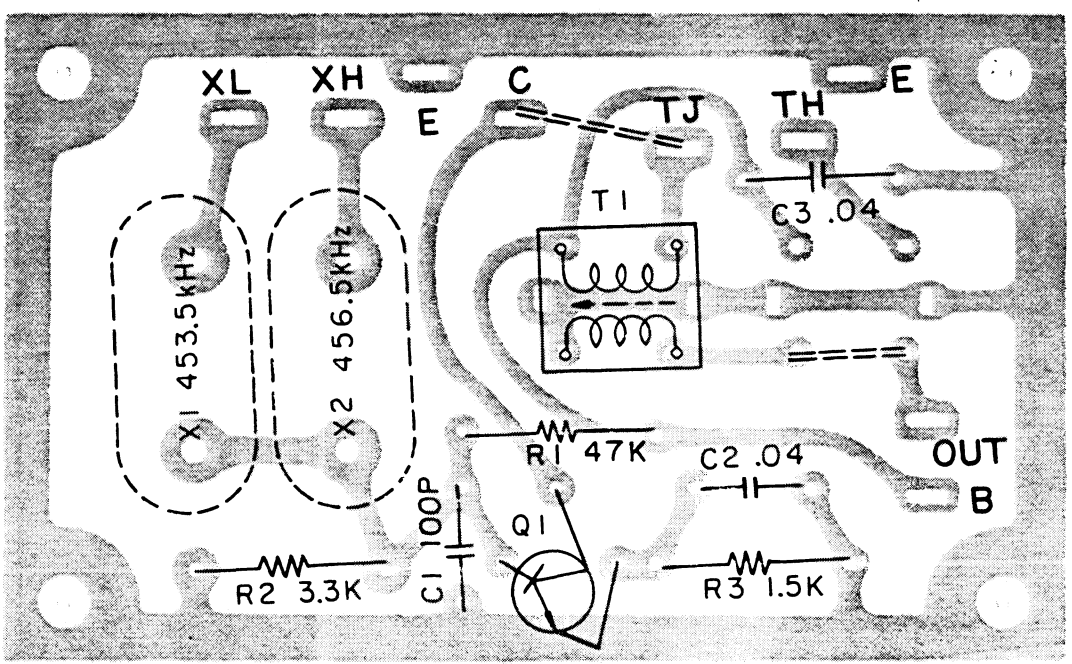

Q1 2SC373

2SC373



**SEALED CIRCUIT ASSEMBLIES-PHANTOM VIEWS**

UC1306J

- AF - 11 x 9 cm wave graphite

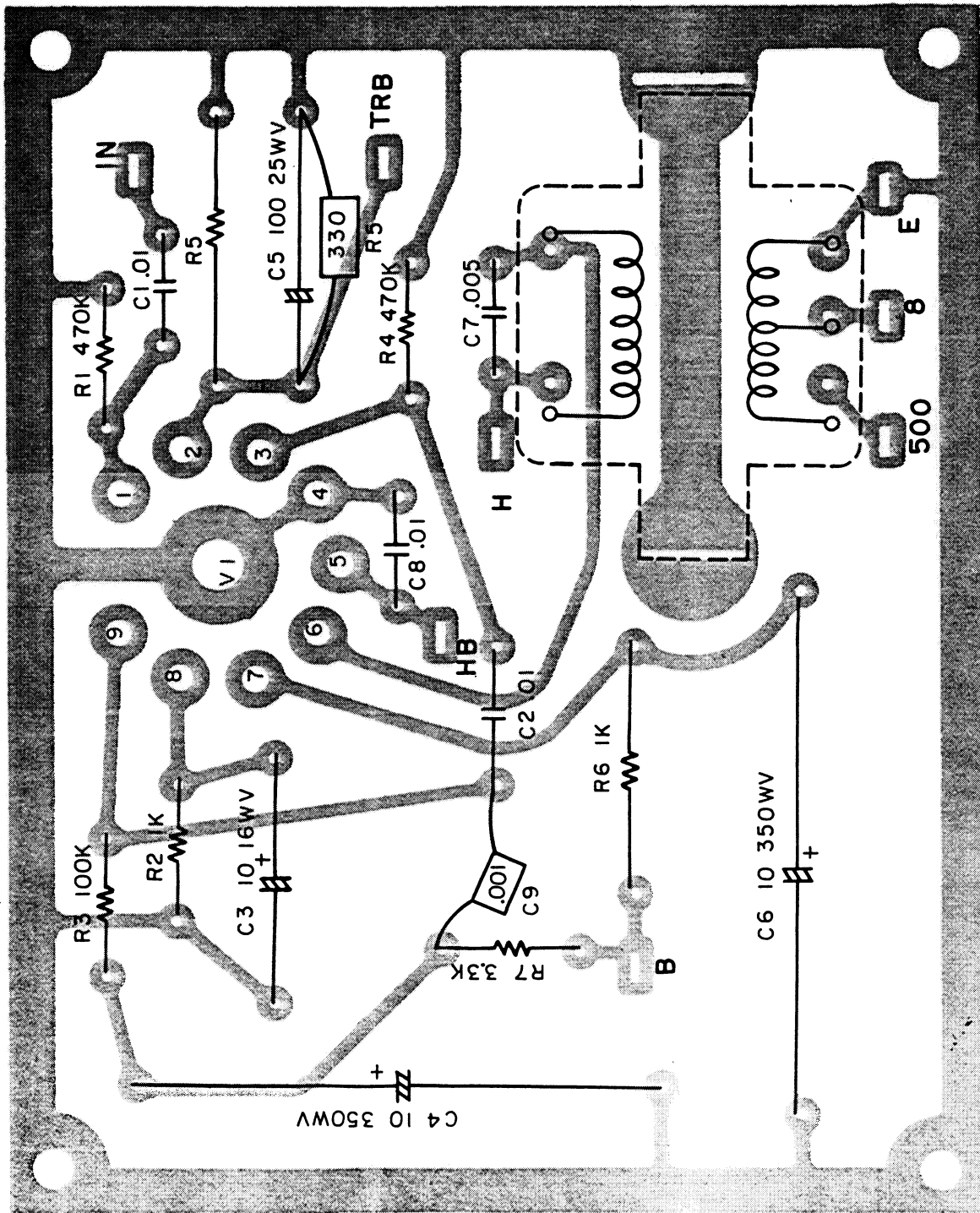

VI 6BM 8

# SEALED CIRCUIT ASSEMBLIES-PHANTOM VIEWS

UC1210J

- JF - 16 x 10 cm wave guide.

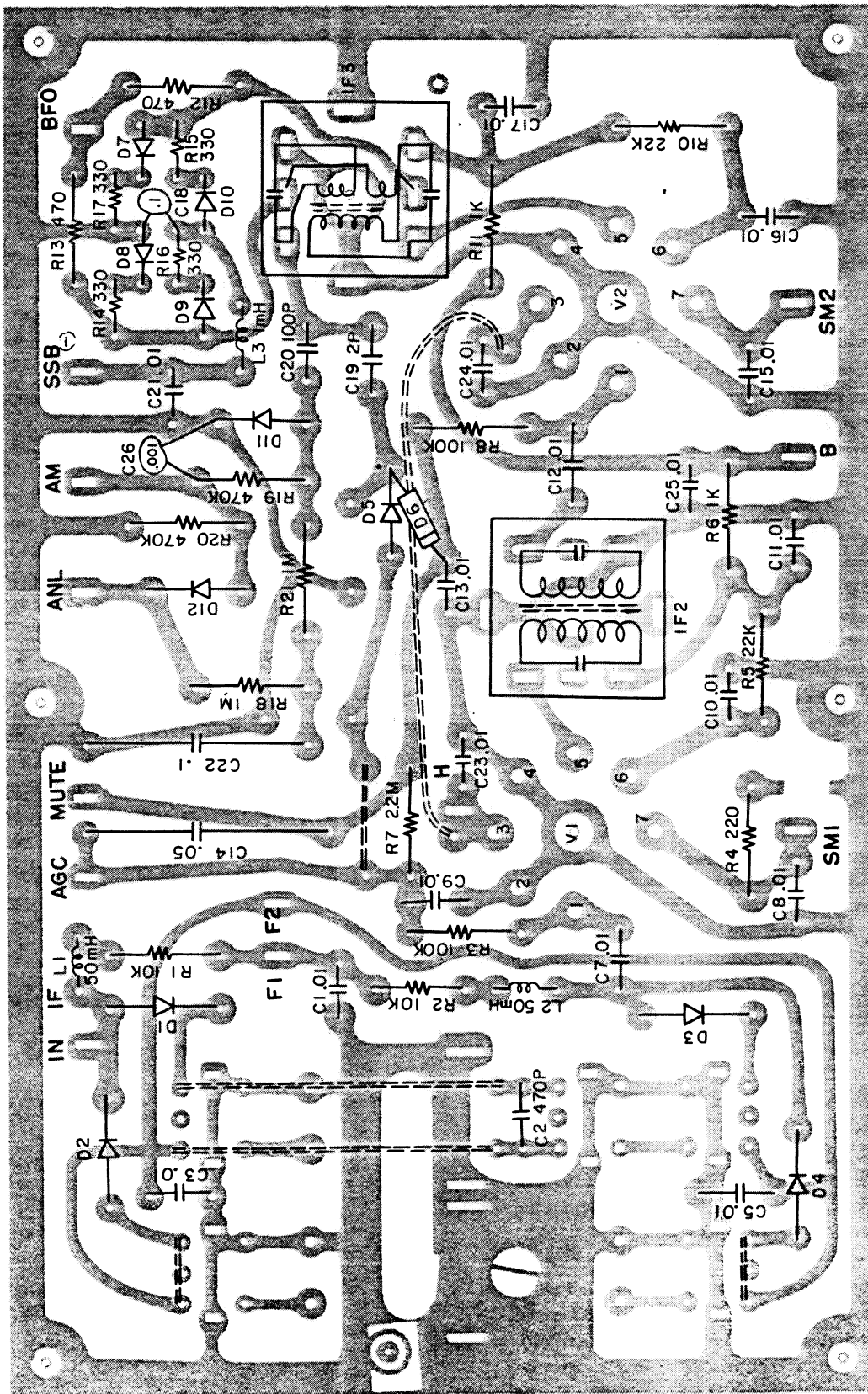

VI,2 6BA6 DI~I2 I N60

# ALIGNMENT PROCEDURE

## I. General

This manual contains information for the alignment and adjustment of communications receiver model JR-310.

## II. Preliminary Operations

### 1. Check of Parts

- 1) Check the REMOTE ant TRCV terminals for normal attachment of the plugs supplied.
- 2) Check the PHONE terminal for normal connection of a  $8\Omega$ , 3W dummy resistor.

### 2. Setting Operating Controls

- 1) Front panel.  
BAND at 3.5  
FUNCTION at AM  
SELECTIVITY at WIDE  
RF GAIN at fully clockwise position
- 2) S · ADJ at center position.
- 3) Set other controls at arbitrary positions.

## III. Adjustment

### 1. The 2nd IF Stage

- 1) Purpose  
To adjust all IF transformers so as to make the 2nd IF stage provide the specified selectivity, gain and sensitivity.
- 2) Measuring sets required  
Standard signal generator (SSG)  
Oscilloscope  
AF vacuum tube voltmeter (VTVM)
- 3) Alignment procedure
  - (1) Connect the oscilloscope and AF vacuum tube voltmeter across the  $8\Omega$  dummy resistor connected to the PHONE terminal.
  - (2) Connect the SSG output to pin 1 (G1) of 6CB6 type tube V3 in RF unit UC-1117J.  
Set up the SSG for an output frequency of 455kHz at 1,000Hz, 30% modulation with the ATT set at approx. 50dB.
  - (3) Check to see that the FUNCTION switch is in the AM position, the SELECTIVITY switch is in the WIDE position, and the RF GAIN control is in the fully clockwise position. Turn the AF GAIN control to the fully clockwise position with other controls left in arbitrary positions.
  - (4) Adjust IF trimmer TC3 in RF unit UC-1117J and the mechanical filter and the cores of matching transformers IFT 2 and 3 in IF unit UC-1210J until the receiver provides the maximum output.
  - (5) Repeat step 4 about three times. If some item is aligned properly and the receiver is saturated with the test signal, continue the alignment with the ATT on the SSG turned down to around 30dB.

### 2. The 1st IF Stage

- 1) Purpose  
To make tracking of the 1st IF turning circuit so as to make the 1st IF stage provide the specified gain.
- 2) Measuring sets required  
Standard signal generator (SSG)  
Oscilloscope  
AF vacuum tube voltmeter (VTVM)
- 3) Alignment procedure
  - (1) Connect the SSG output to pin 2 (G1) of 6BL8 type tube V2 in RF unit UC-1117J.  
Set up the SSG for an output frequency of the 5MHz order at 1,000Hz, 30% modulation with the ATT set at approx. 30dB.
  - (2) Connect the oscilloscope and the AF VTVM across the  $8\Omega$  dummy resistor connected to the PHONE terminal.  
Check to see that the FUNCTION switch is in the AM position, the SELECTIVITY switch is in the WIDE position, and the RF GAIN and AF GAIN controls in the fully clockwise positions. Leave other controls in arbitrary positions.
  - (3) With the main dial and the IF TUNE control knob set to graduations 500 respectively, set the output frequency of the SSG to 5.455MHz. Adjust both the upper and lower cores of IF transformer IFT1 in RF unit UC-1117J until the receiver provides the maximum output.
  - (4) With the main dial and the IF TUNE control set to graduations 100 respectively, set the output frequency of the SSG to 5.855MHz. Adjust 1st IF trimmers TC1 and TC2 in RF unit UC-1117J until the receiver provides the maximum output.
  - (5) Repeat steps (3) and (4) about three times. If some item aligned properly and the receiver is saturated with the test signal, continue the alignment with the ATT on the SSG turned down to around 10dB.

### 3. BRO

- 1) Purpose  
To check the ring detector for normal carrier oscillation.
- 2) Measuring set required.  
RF vacuum tube voltmeter (VTVM).
- 3) Alignment procedure
  - (1) Set the FUNCTION switch at the USB position with other controls left arbitrary positions.
  - (2) Connect the probe of the RF VTVM to the OUT pin in BFO unit UC-1211J. Adjust the core of BFO tuning coil T1 until the BFO delivers the maximum output. Note that the RF VTVM should be used with its measuring range set to the 1V range.



# ALIGNMENT PROCEDURE

## The 1st OSC

- 1) Purpose  
To insure the stable operation of the 1st local oscillator in the 1st mixer circuit.
- 2) Measuring set required  
RF vacuum tube voltmeter (VTVM)
- 3) Alignment procedure
  - (1) Connect the probe of the RF VTVM to pin 2 (G1) of 6BL8 type tube V2 in RF unit UC-1117J. Set the VTVM to a measuring range of approx. 10V.
  - (2) Place the BAND switch in position 3.5. Set the FUNCTION switch at the AM position with other controls left at arbitrary positions.
  - (3) Adjust the core of 3.5MHz oscillator coil L7 until the 1st OSC provides the maximum output. Rotate the core counterclockwise one complete turn from the above position to make the oscillator operation stable and fix the core in that position.
  - (4) Turn the BAND switch to position 7. Adjust the core of 7MHz oscillator coil L6 in the same manner as mentioned in step 3 above. Adjust oscillator coil L5 for Band 14, oscillator coil L4 for Band 21 and oscillator coil L3 for Band 28.0 in the same manner as described in steps (2) and (3).  
For Band 28.5, check the 1st OSC for normal operation only.

## Coil Pack

- 1) Purpose  
To make tracking of the receiver for its operation with the maximum sensitivity through tuning of each coil trimmer in the coil pack to a desired receiving frequency.
- 2) Measuring sets required  
Standard signal generator (SSG)  
Oscilloscope  
AF vacuum tube voltmeter (VTVM)
- 3) Alignment procedure
  - (1) Set the panel controls as follows:
    - a) IF TUNE at graduation 300
    - b) Main dial at graduation 300
    - c) RF GAIN at fully clockwise position
    - d) AF GAIN at fully clockwise position
    - e) FUNCTION at AM
    - f) SELECTIVITY at WIDE
    - g) RIT at a counterclockwise position (position RIT OFF)
    - h) Operate the BAND switch and the RF TUNE control as instructed for each alignment.
  - (2) Connect the oscilloscope and AF VTVM across the 8Ω dummy resistor connected to the PHONE

terminal.

- (3) Connect the SSG output to the ANT terminal on the rear panel. Set up the SSG for 1,000Hz, 30% modulation with the ATT set to around 40dB.
- (4) Alignment of low-band ANT and RF coils
  - a) With the BAND switch placed in position 3.5, set the RF TUNE control around the center of the 3.5 scale band.
  - b) Set the output frequency of the SSG to 3.8MHz and adjust the 3.5MHz cores for the ANT and the RF coils until the receiver provides the maximum output.
  - c) With the BAND switch turned to position 14, set the RF TUNE control around the center of the 14 scale band.
  - d) Set the output frequency of the SSG, and adjust the 14MHz trimmer for the ANT and the RF coils.

Repeat steps a) through d) three times to complete the alignment of the low-band ANT and RF coils.
- (5) Alignment of high-band ANT and RF coils
  - a) With the BAND switch placed in position 21, set the RF TUNE control around the center of the 21 scale band.
  - b) Set the output frequency of the SSG to 21.3MHz and adjust the 21MHz cores for the ANT and the RF coils until the receiver provides the maximum output.
  - c) With the BAND switch placed in position 28.0, set the RF TUNE control near the left limit of the 28 scale band.
  - d) Set the output frequency of the SSG to 28.3MHz and adjust the 28MHz trimmers for the ANT and the RF coils.

Repeat steps a) through d) three times to complete the alignment of the high-band ANT and RF coils.

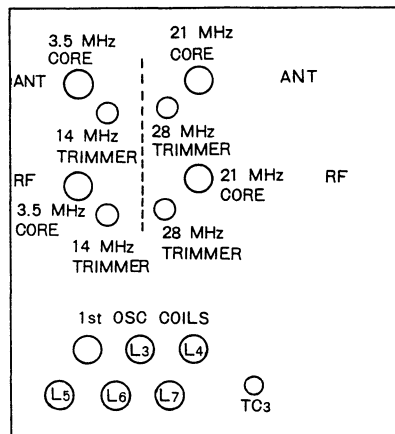

Reference: Layout of ANT. and RF Coil trimmers in RF Unit UC-1117J.

## ALIGNMENT PROCEDURE

- (6) Where the receiver sensitivity is raised with progress of the alignment, continue the alignment with the ATT on the SSG turned down to approx. 10dB. Also, adjust the AF GAIN control so that it is roughly set for the standard output.

### 6. S Meter

#### 1) Purpose

To set the S meter for zero deflection.

#### 2) Measuring set required

No measuring set is required.

#### 3) Alignment procedure

- (1) Set up the receiver for a condition where the alignment of the 14MHz band is completed in the coil pack alignment given in item (5). above.
- (2) With the ANT terminals short-circuited, adjust the S.ADJ control until the needle of S meter is set to zero. In this case, be sure that the meter is not set to an apparent zero point, because the meter incorporates an anti-deflection circuit which prevents the needle from deflecting in the minus direction beyond the zero point.

### 7. 5MHz Trap Coil

#### 1) Purpose

To attenuate the interference signal having the same frequency as the 5MHz order of the 1st IF for improvement of the IF interference ratio.

#### 2) Measuring sets required

Standard signal generator (SSG)

Oscilloscope

AF vacuum tube voltmeter (VTVM)

#### 3) Alignment procedure

- (1) Adjustment of 5MHz trap coil by ANT terminals
  - a) Place the receiver in the condition where the alignment of the low-band ANT and RF coils are completed in the coil pack alignment given in item 5 and receive the 7MHz band with the maximum sensitivity.  
Set up the SSG for an output frequency of 7.3MHz at 1,000Hz, 30% modulation with the ATT set to 10dB.  
With the BAND switch set at position 7 and the main dial and IF TUNE control at graduations 300 on the receiver, turn the RF TUNE control to a setting around graduation 7 to tune the receiver for the output frequency of the SSG.
  - b) Leave the receiver under the above condition and change the output frequency of the SSG to 5.655MHz with the ATT set around 60dB. Apply the output of the SSG to the receiver and check to see that the receiver delivers an output.

Adjust the 5MHz trap until the receiver provides the minimum output.

Note that the ATT setting on the SSG may be varied within the range where the minimum output of the receiver is easily checked up.

#### (2) Adjustment of 5MHz trap coil in RF unit UC-1117J

- a) Place the receiver in the condition where the alignment of the low-band ANT and RF coils are completed in the coil pack alignment given in item 5.

Proceed just in the same manner as described in (1), a) to receive the 7.1MHz output of the SSG except that the output frequency of the SSG is set to 7.1MHz and that the main dial and the IF TUNE control on the receiver are set to graduations 100.

- b) Turn the RF TUNE control counterclockwise by about 20° from the setting for the 7.1MHz to the point where noise appears. Fix the RF TUNE control to the point where the maximum noise appears. This noise is the 5MHz order noise. So, adjust the 5MHz trap coil in the UC-1117J until the receiver delivers the minimum noise output.

### 8. RIT

#### 1) Purpose

To coincide the transmitting and receiving frequencies with each other at the 0 position of RIT switch when this receiver is operated with the model TX-310 on a combined transmitter-receiver basis.

#### 2) Measuring sets required

Standard signal generator (SSG)

Oscilloscope

AF generator

#### 3) Alignment procedure

- (1) Place the receiver in the condition where the alignment of the high-band ANT and RF coils are completed in the coil pack alignment given in item 5. and receive the 14MHz band with the maximum sensitivity.

Set up the SSG for an output frequency of 14.2MHz under no modulation with the ATT set at 40dB.

With the BAND switch set at position 14 and the main dial and IF TUNE control at graduations 200 on the receiver, turn the RF TUNE control to a setting around graduation 14 to tune the receiver for the output frequency of the SSG.

Note that the FUNCTION switch should be switched from AM to USB.

- (2) With the oscilloscope set for sweep range EXT

## ALIGNMENT PROCEDURE

HORIZONTAL, apply the 1,000Hz, 1V output of the AF generator to terminal H.

- (3) Set the RIT control to 0 correctly and then finely adjust the main tuning dial until the Lissajous' figure on the oscilloscope comes to a standstill to form a circular pattern.
- (4) Turn the RIT control counterclockwise to the RIT OFF position. Adjust the RIT 0 ADJ control until the Lissajous' figure turns into the circular pattern again. Mind that step (4) should be completed within one min. Otherwise, repeat steps (3) and (4).
- (5) Additional matter  
RIT may be accomplished by zero beating the VFO with the test signal in lieu of its zero adjustment, which is conducted through the use of an oscilloscope set up for representation of Lissajous' figure.

### III. Specifications of Measuring Sets Required

- 1) Standard signal generator (SSG)  
Frequency: 250kHz to 30MHz  
Output: 0 to 100dB/ $\mu$ V  
Should contain little FM component under no modulation.
- 2) Oscilloscope Equivalent to model CO · 505S
- 3) AF vacuum tube voltmeter (VTVM)  
Frequency: 100Hz to 10kHz  
Input resistance: More than 1M $\Omega$   
Range: 10mV to 30V FS
- 4) AF generator  
Output impedance: Less than 600 $\Omega$   
Output voltage: 1V max.  
Frequency: 300Hz to 5kHz  
Distortion factor: Less than 0.5% (1,500Hz)
- 5) RF vacuum tube voltmeter (VTVM)  
Input impedance: More than 1M $\Omega$  ;  
Less than 20pF  
Range: 10mV to 300V, FS  
(Operable with ATT)