

**ICOM**

INSTRUCTION/PROGRAMMING MANUAL

VHF FM TRANSCEIVER

**IC-V68**

UHF FM TRANSCEIVER

**IC-U68**

---

Icom Inc.

---

---

## IMPORTANT

---

**READ ALL INSTRUCTIONS** carefully and completely before using the transceiver.

**SAVE THIS INSTRUCTION MANUAL**—This instruction manual contains important operating instructions.

This transceiver has both channel indication and frequency indication modes. Before operating in channel indication mode, each channel must be programmed in frequency indication mode. Refer to pg. 27, 41 for details.

---

## EXPLICIT DEFINITIONS

---

The explicit definitions below apply to this instruction manual.

WORD	DEFINITION
<b>⚠ WARNING</b>	Personal injury, fire hazard or electric shock may occur.
<b>CAUTION</b>	Equipment damage may occur.
<b>NOTE</b>	If disregarded, inconvenience only. No risk of personal injury, fire or electric shock.

---

## CAUTIONS

---

**⚠ WARNING! NEVER** hold the transceiver so that the antenna is very close to, or touching exposed parts of the body, especially the face or eyes, while transmitting. The transceiver will perform best if the microphone is 5 to 10 cm (2 to 4 in) away from the lips and the transceiver is vertical.

**⚠ WARNING! NEVER** operate the transceiver with a headset or other audio accessories at high volume levels. Hearing experts advise against continuous high volume operation. If you experience a ringing in your ears, reduce the volume level or discontinue use.

**NEVER** connect the transceiver to an AC outlet or to a power source of more than 16 V DC. Such a connection will damage the transceiver.

**NEVER** connect the transceiver to a power source that is DC fused at more than 5 A. Accidental reverse connection will be protected by this fuse, higher fuse values will not give any protection against such accidents and the transceiver will be ruined.

**NEVER** attempt to charge alkaline or dry cell batteries. Beware that external DC power connections will charge batteries inside the battery case. This will damage not only the battery case but also the transceiver.

**DO NOT** push the PTT when not actually desiring to transmit.

**DO NOT** allow children to play with any radio equipment containing a transmitter.

**DO NOT** operate the transceiver near unshielded electrical blasting caps or in an explosive atmosphere.

**AVOID** using or placing the transceiver in direct sunlight or in areas with temperatures below  $-10^{\circ}\text{C}$  ( $+14^{\circ}\text{F}$ ) or above  $+60^{\circ}\text{C}$  ( $+140^{\circ}\text{F}$ ).

**BE CAREFUL!** When transmitting for a long time at high output power, the rear panel will become hot.

The use of non-Icom battery packs/chargers may impair transceiver performance and invalidate the warranty.

Even when the transceiver power is OFF, a slight current still flows in the circuits. Remove the battery pack or case from the transceiver when not using it for a long time. Otherwise, the battery pack or installed dry cell batteries will become exhausted.

## UNPACKING

The following accessories are included with the transceiver:

- ① Flexible antenna ..... 1
- ② Belt clip ..... 1
- ③ Battery case (the BP-99 comes attached to the transceiver) .. 1

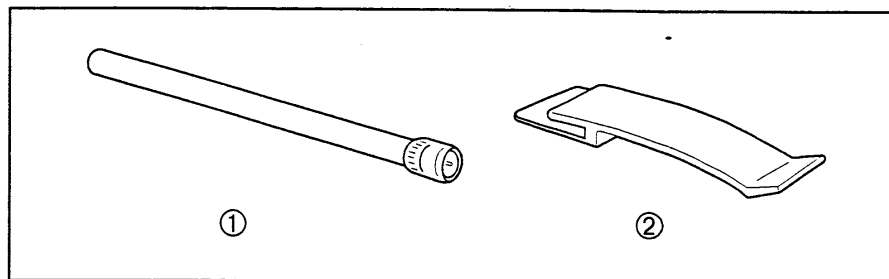

---

# TABLE OF CONTENTS

---

IMPORTANT .....	i	■ Memory channel selection .....	11
EXPLICIT DEFINITIONS .....	i	■ Memory write .....	11
CAUTIONS .....	i	■ Memory clearing .....	11
UNPACKING .....	ii	■ Receive and transmit .....	12
TABLE OF CONTENTS .....	iii-iv	■ Functions for receive .....	12
<b>1 PANEL DESCRIPTION .....</b>	<b>1 – 4</b>	◇ Monitor function .....	12
■ Front, side and top panels .....	1	◇ Power saver .....	12
◇ Keypad .....	2	■ Functions for transmit .....	13
■ Function display .....	4	◇ Transmit inhibit .....	13
<b>2 BATTERY PACK AND ACCESSORIES .....</b>	<b>5 – 8</b>	◇ Transmit inhibit while busy .....	13
■ Battery case .....	5	◇ Time-out timer .....	14
◇ Dry cell battery installation .....	5	◇ Setting output power .....	14
◇ Battery pack cautions .....	5	<b>4 REPEATER OPERATION .....</b>	<b>15</b>
■ Charging when Ni-Cd batteries are installed .....	6	■ General .....	15
■ Operation with an optional cable .....	6	■ Setting offset frequencies .....	15
■ Accessory attachment .....	7	<b>5 SUBAUDIBLE TONE AND SCRAMBLER .....</b>	<b>16 – 18</b>
◇ Antenna .....	7	■ Pre-setting .....	16
◇ Belt clip .....	7	■ Setting the tone encoder .....	16
■ Optional battery pack .....	7	■ Setting the tone decoder .....	17
◇ Battery pack life .....	7	◇ Available tone frequencies .....	17
◇ Rapid charging with the BC-119 .....	8	■ Tone squelch and voice scrambler operation .....	18
◇ Multiple charging with the BC-121 .....	8	◇ Tone squelch operation .....	18
<b>3 BASIC OPERATION .....</b>	<b>9 – 14</b>	◇ Voice scrambler operation .....	18
■ Setting a frequency .....	9	■ Noise mute function .....	18
◇ Read me first .....	9	<b>6 DTMF MEMORY ENCODER .....</b>	<b>19 – 20</b>
◇ Operation .....	9	■ Programming a DTMF code .....	19
■ Tuning steps .....	10	■ Transmitting a DTMF code .....	19
◇ 1 MHz tuning .....	10	◇ Manual transmission .....	19
■ Lock function .....	10	◇ DTMF memory transmission .....	19

■ Function restrictions for channel indication mode .....	20	■ Other settings for ANI operation .....	31
<b>7 SCAN FUNCTIONS .....</b>	<b>21 – 22</b>	◇ Code memory indication .....	31
■ Scan types .....	21	◇ Code memory overwrite .....	31
◇ Empty scan .....	21	◇ Code transmit delay time .....	31
◇ Busy scan .....	21	◇ Scan function .....	31
■ Pre-settings .....	21	◇ Code transmit delay time .....	31
◇ Turning the scan function ON/OFF during channel indication .....	21	<b>10 OTHER FUNCTIONS .....</b>	<b>32</b>
◇ Selecting the scan type .....	21	■ Reversing the display .....	32
■ Scan start/stop .....	22	■ Confirmation beeps .....	32
■ Setting skip channels .....	22	■ Display lighting .....	32
<b>8 PAGER AND CODE SQUELCH .....</b>	<b>23 – 26</b>	◇ 5 sec. timer .....	32
■ Pager function .....	23	◇ Continuous lighting .....	32
■ Code programming .....	23	■ CPU resetting .....	32
◇ Before programming .....	23	<b>11 COMMON SET MODE .....</b>	<b>33 – 37</b>
◇ Code channel assignment .....	23	■ General .....	33
◇ Code programming .....	24	■ Item descriptions .....	33
■ Pager operation .....	25	<b>12 CLONING OPERATION .....</b>	<b>38</b>
◇ Calling a specific station .....	25	■ General .....	38
◇ Waiting for a call from a specific station .....	25	◇ Connections .....	38
■ Code squelch .....	26	■ Cloning between transceivers .....	38
<b>9 ANI FUNCTION .....</b>	<b>27 – 31</b>	■ Cloning error .....	38
■ Function description .....	27	<b>13 OPTIONS INSTALLATION .....</b>	<b>39</b>
◇ Mode selection .....	27	<b>14 SPECIFICATIONS AND OPTIONS .....</b>	<b>40</b>
■ Preparation .....	28	■ Specifications .....	40
■ Operation (in channel indication mode) .....	29	■ Options .....	40
◇ Calling a specific station .....	29	<b>15 MODE FLOW CHART .....</b>	<b>41–42</b>
◇ Calling group stations .....	29		
◇ Using other selective codes .....	29		
◇ Waiting for a call .....	30		

# 1

## PANEL DESCRIPTION

### ■ Front, side and top panels

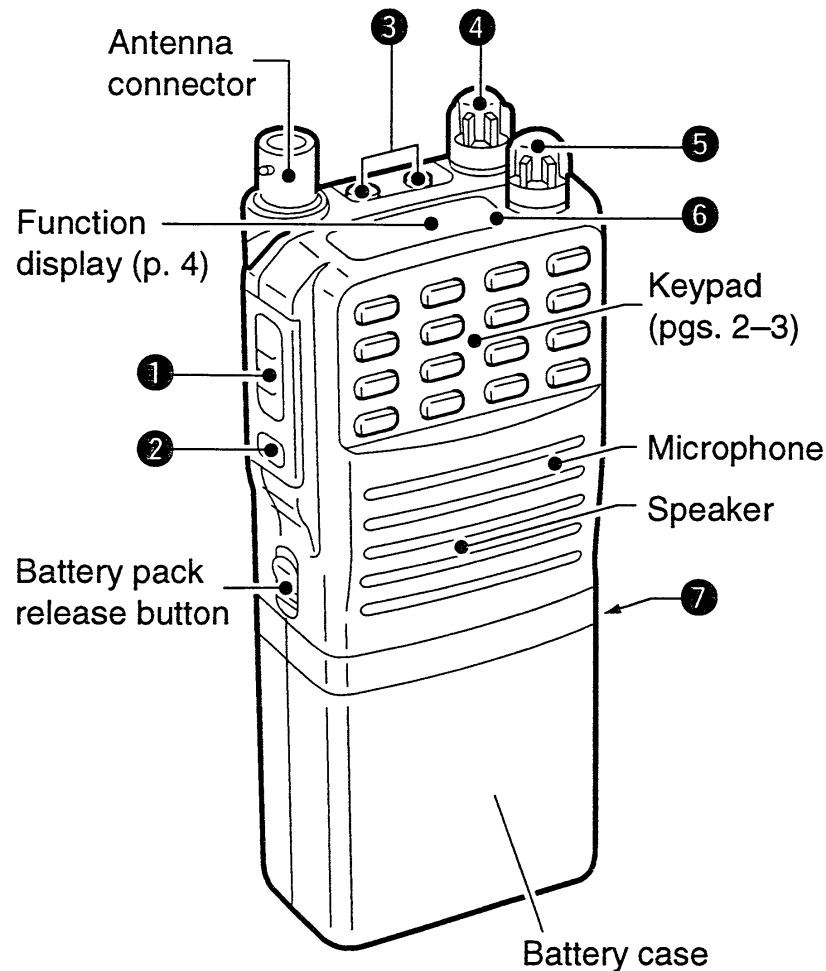

#### ① PTT SWITCH [PTT] (p. 12)

- ➔ Push and hold for voice transmission; release to receive.
- ➔ Push momentarily for control code transmission while the ANI function is in use.

#### ② FUNCTION SWITCH [FUNC]

- ➔ Activates secondary functions of other switches. (pgs. 3–4)
- ➔ When pushed once, then immediately pushed and held a second time, activates the monitor function. (p. 15)

#### ③ EXTERNAL SPEAKER AND MICROPHONE JACKS [SP], [MIC]

Connect an optional speaker-microphone or headset, if desired. The internal microphone and speaker will not function when either is connected.

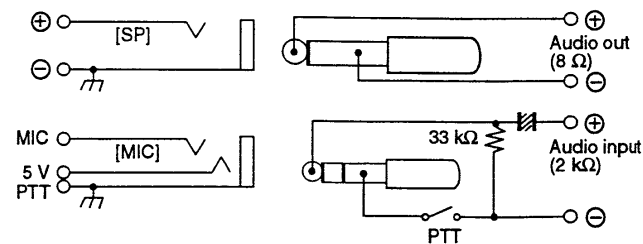

This connection does not apply when a condenser microphone is connected.

#### ④ POWER/VOLUME CONTROL [OFF/VOL] (p. 12)

- ➔ Turns the power ON and OFF, and adjusts the audio.
- ➔ When turning power ON, channel indication and frequency indication can be toggled. (pgs. 27, 41)

◇ Keypad

5 TUNING DIAL [DIAL] (pgs. 9–11)

- Selects the operating channel or frequency depending on the display mode.
- Selects the frequency in 1 MHz steps or memory channels while pushing [FUNC] during frequency indication.

6 TRANSMIT/BUSY INDICATOR (p. 12)

- Lights red while transmitting.
- Lights green while the channel is busy.

7 EXTERNAL DC POWER JACK [DC 12.5 V] (p. 6)

- Connects a wall charger or a 12–16 V DC power source for charging.
- Connects a 6–16 V DC power source for operation.

**CAUTION:** Operation with an external DC power source simultaneously charges batteries inside the battery case or the battery pack. When using dry cell batteries this may cause battery leakage and damage the transceiver; when using a Ni-Cd battery pack this may cause battery overcharging and shorten the life of the battery pack.

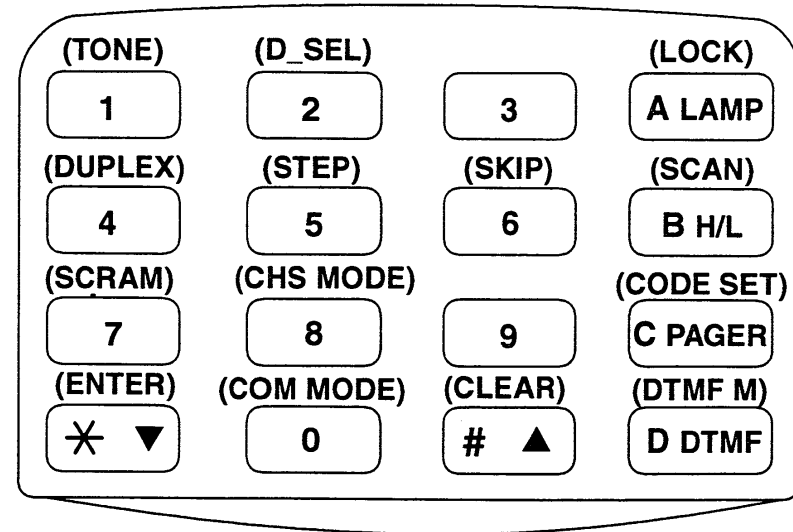

The illustration above is labeled with individual key functions for your reference—the actual keypad is only labeled with 0 to 9, # \* and A to D.

Functions in brackets are secondary functions and are accessed while pushing [FUNC]. (See the table on the following page.)

While pushing [PTT], DTMF codes can be manually transmitted with any of the keys.

# 1 PANEL DESCRIPTION

KEY	FUNCTION	SECONDARY FUNCTION	KEY	FUNCTION	SECONDARY FUNCTION
(TONE) 1	Direct frequency input.	Toggles tone encoder and tone squelch ON/OFF. (pgs. 16, 18)	9	Direct Frequency input.	None.
(D_SEL) 2		Toggles dial select function, MHz↔M CH (p. 11) The dial select function can be used with the tuning dial while pushing [FUNC].	(COM MODE) 0		Selects common set mode. (p. 33)
3		None.	(ENTER) * ▼	Increment/decrement the memory channel.	Programs frequency, etc. into memory channels.
(DUPLEX) 4		Toggles semi duplex ON/OFF. (p. 15) “-” or “+” indicates – duplex or + duplex, respectively.	(CLEAR) # ▲		Clears memory channels. • Cleared memories flash during freq. indication; do not appear during ch. indication.
(STEP) 5		Selects tuning step setting display. (p. 10)	(LOCK) A LAMP	Push to toggle the display backlight ON and OFF. • Backlight goes OFF after 5sec.; push and hold to light continuously.	Toggles the lock function ON/OFF. (p. 10)
(SKIP) 6		Toggles the skip setting ON/OFF for memory skip scan. (p. 22)	(SCAN) B H/L	Selects high/low output power.	Starts/stops the scan function. (p. 22)
(SCRAM) 7		Toggles voice scrambler operation ON/OFF. (p. 18) • An optional UT-88 is required.	(CODE SET) C PAGER	Toggles pager/code squelch or ANI ON/OFF.	Selects code memory set mode. (p. 24)
(CHS MODE) 8		Selects channel specific set mode. (p. 41)	(DTMF M) D DTMF	Selects DTMF code transmit.	Selects DTMF memory set mode. (p. 19)



## ■ Function display

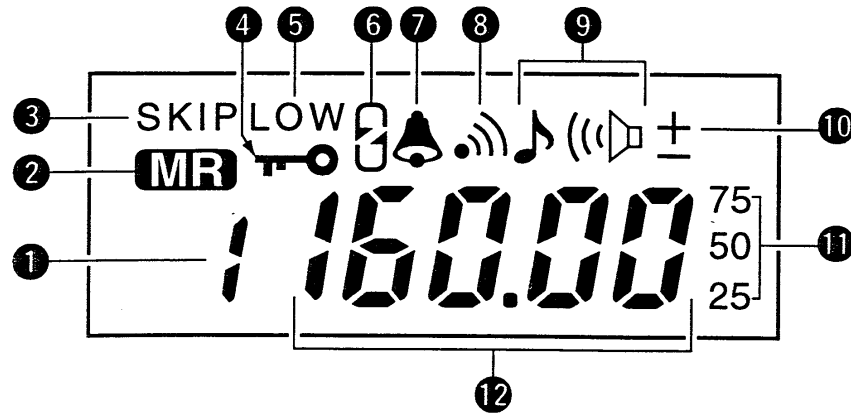

- ① MEMORY CHANNEL NUMBER**  
Indicates the selected memory channel.
- ② MEMORY INDICATOR**  
Appears during regular mode and flashes during scan operation.
- ③ SKIP INDICATOR**  
Appears when the channel is set as a skip channel.
- ④ LOCK INDICATOR**  
Appears while the lock function is activated.
- ⑤ LOW POWER INDICATOR**  
Appears when a channel is set for low power.
- ⑥ VOICE SCRAMBLER INDICATOR**  
Appears when the (optional) voice scrambler is set for a channel.

- ⑦ CODE SQUELCH INDICATOR**  
Appears when code squelch is set for a channel.
- ⑧ PAGER/ANI INDICATOR**  
Appears when the pager/ANI function is set for a channel.
- ⑨ TONE INDICATORS**  
♪ or ♪((( ))) appear when the tone encoder or tone squelch function is set for a channel, respectively.
- ⑩ SEMI DUPLEX INDICATORS**  
+ or - appears when semi duplex is set for a channel (indicates shift direction).
- ⑪ kHz INDICATORS**  
Indicate the last digit of the selected frequency and are related to the selected tuning step.
- ⑫ FREQUENCY INDICATORS**  
Indicate the selected frequency.

## ■ Battery case

*To remove:*

Push and hold the battery release button upwards, then slide the battery case to the right with the transceiver facing you.

*To attach:*

Mate the notched ends of the transceiver and the battery case, and slide the battery case into place until a click sounds.

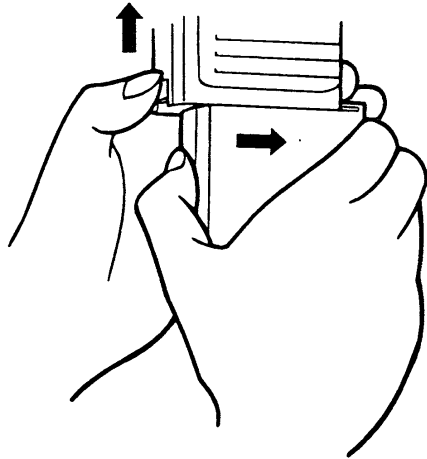

## ◇ Dry cell battery installation

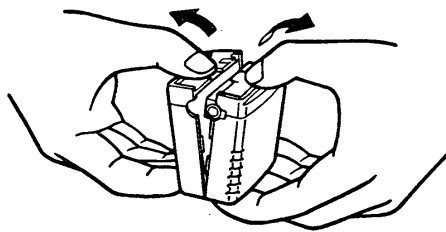

Open the battery case.

Install AA (R6) × 6 dry cell batteries.

- Pay attention to the polarities.

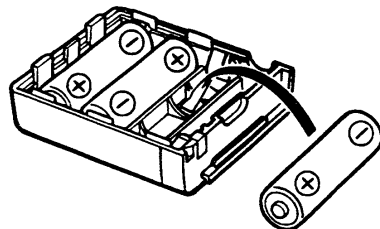

## ◇ Battery pack cautions

*When installing Ni-Cd batteries:*

- **Make sure** all Ni-Cd cells are the same brand, type and capacity.
  - **Never** mix old and new batteries.
- Either of the above may cause a fire hazard or damage the transceiver.

*When installing dry cell or alkaline batteries:*

- **Never** connect DC power to the transceiver. Such a connection always charges the installed batteries and will damage the transceiver.

*For both Ni-Cd and dry cell batteries:*

- **Never** incinerate used battery cells since internal battery gas may cause them to rupture.
- **Never** expose a detached battery case to water. If the battery case gets wet, be sure to wipe it dry before using.

## ■ Charging when Ni-Cd batteries are installed

(for supplied BP-99 only)

**CAUTION:** Only Ni-Cd batteries can be charged. NEVER connect a wall charger when dry cell batteries are installed—the transceiver and/or battery case may be damaged.

Connect the optional BC-105A/D/V to the [DC] jack on the battery pack.

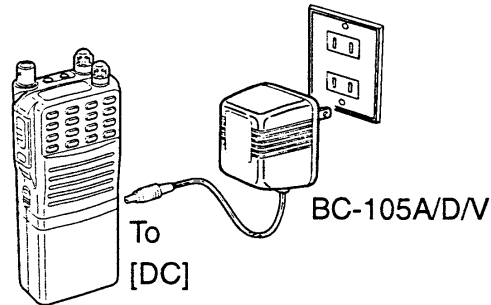

- Approx. charging period: 15 hr.
- DO NOT turn power ON while connecting the BC-105A/D/V. Current capacity is insufficient.
- The optional CP-13L cigarette lighter cable with noise filter or OPC-288L DC power cable with a 12 to 16 V DC power source can also be used. In this case, the transceiver can be left ON while charging.

## ■ Operation with an optional cable (for supplied BP-99 only)

Connect an optional charger or cable to the transceiver as illustrated below. Be careful of battery overcharging as the connected battery is charged simultaneously.

**CAUTION:** Remove dry cell batteries from the BP-99 battery case when using an external power source.

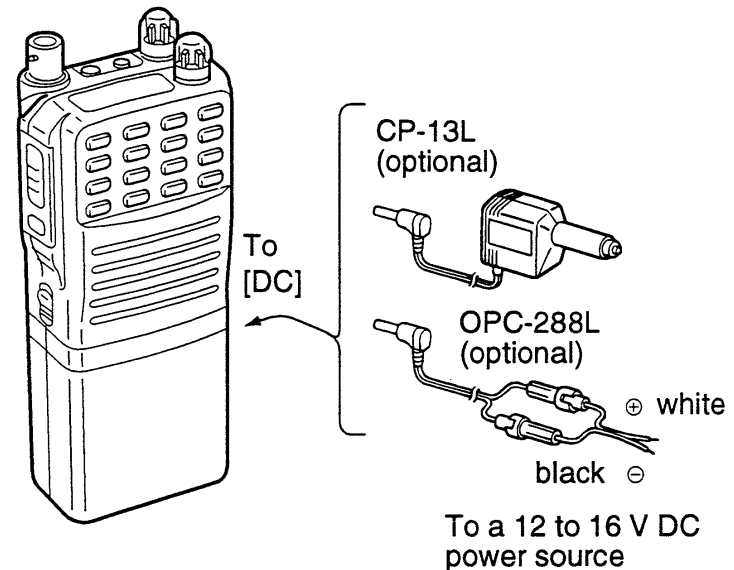

## 2 BATTERY PACK AND ACCESSORIES

### ■ Accessory attachment

#### ◇ Antenna

Connect the supplied flexible antenna to the antenna connector and rotate the antenna clockwise.

/// **CAUTION:** Transmitting without an antenna may damage the transceiver.

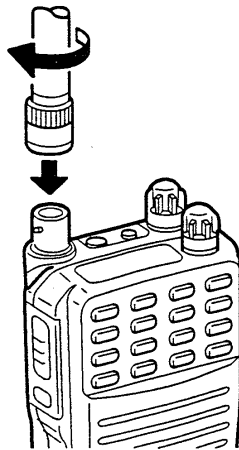

#### ◇ Belt clip

*To attach:*

Slide the belt clip into the plastic loop on the back of the transceiver.

*To remove:*

Push the top of the belt clip towards the transceiver and at the same time, push it downward and free of the plastic loop.

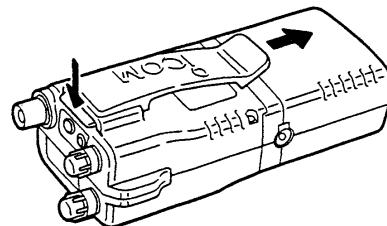
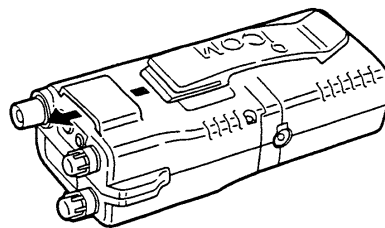

### ■ Optional battery pack

The optional BP-157A, BP-160 or BP-174 battery pack include rechargeable Ni-Cd batteries and can be charged approx. 300 times. Charge the battery pack before first operating the transceiver or when the battery pack becomes exhausted.

If you want to be able to charge the battery pack more than 300 times, the following points should be observed:

1. Avoid overcharging. The charging period should be less than 48 hours.
2. Use the battery until it becomes almost completely exhausted under normal conditions. We recommend battery charging just after transmitting becomes impossible.

#### ◇ Battery pack life

When the operating period becomes extremely short even after charging the battery pack fully, a new battery pack is needed.

### ◇-Rapid charging with the BC-119

The optional BC-119 provides rapid charging of optional Ni-Cd battery packs. The following are additionally required:

- One AD-66
- An AC adapter (may be supplied with the BC-119 depending on version).

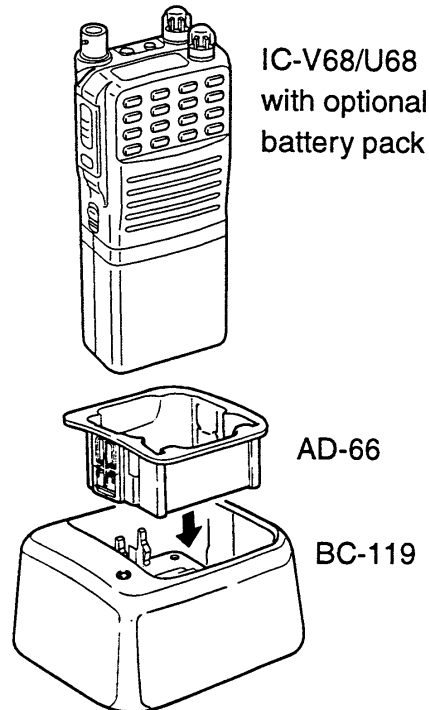

Approx. charging period:  
1.5 to 2 hrs.

### ◇ Multiple charging with the BC-121

The optional BC-121 allows up to 6 Ni-Cd batteries to be charged simultaneously. The following are additionally required:

- Six AD-66's
- An AC adapter (may be supplied with the BC-121 depending on version)

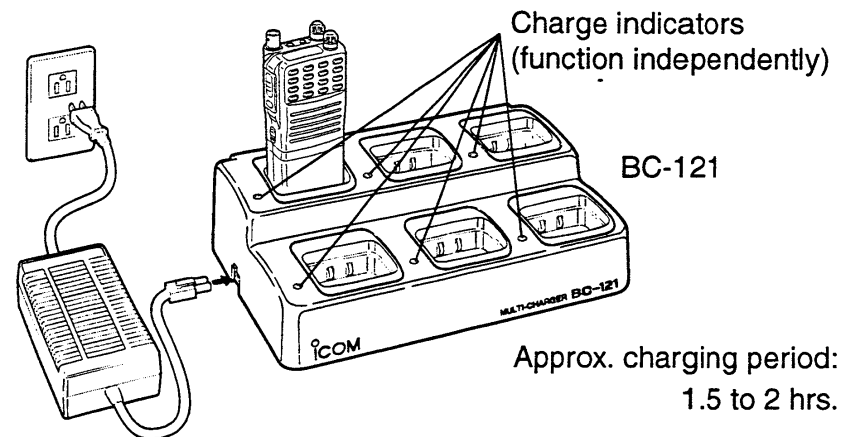

#### NOTE:

- *When the indicator goes off while a battery pack is inserted:*  
May be a poor connection—re-insert the battery pack.
- *When the indicator flashes orange:*  
The connected AC (or DC) power has dropped—check the power source.
- *When the indicator flashes red:*  
The internal protection circuit has activated—indicating a

battery pack (or charger) problem. Re-insert the battery pack. If the flashing continues, contact your dealer.

#### CAUTION:

The transceiver power **MUST** be turned **OFF** during charging otherwise:

- The battery will not be charged correctly.
- The battery life may be shortened.

*The transceiver cannot be operated while charging.*

# 3

## BASIC OPERATION

### ■ Setting a frequency

#### ◇ Read me first

The IC-V68/U68 has 2 basic operating modes: channel indication mode and frequency indication mode. To set a frequency, the transceiver must be in frequency indication mode. See p. 27 for details on mode selection.

The transceiver uses memory channels for storage of frequencies (as well as tuning steps, tones, etc.). When turning power OFF or changing memory channels, the previously displayed frequency cannot be recalled unless it has been stored into a memory channel. Therefore, when you want to keep a displayed frequency for later recall, you must program it into a memory channel by pushing [FUNC] + [\*] for 1 sec.

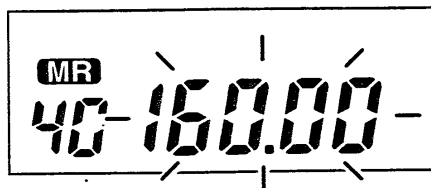

Frequency readout blinks until [FUNC] + [\*] are pushed for 1 sec.

#### ◇ Operation

① Push [\*] or [#] to select the memory channel to be programmed.

- The dial select function may be convenient for channel selection (see p. 10).

② Push 5 digit keys starting from the 10 MHz digit (within 2 sec. of each other) to input the desired frequency.

- The 5th digit is for kHz entry (0, 2.5, 5.0 or 7.5).
- [DIAL] rotation also changes the frequency (in the set tuning steps—see next page).
- Acceptable frequency range:  
IC-V68 → 136 to 174 MHz  
IC-U68 → 400 to 470 MHz

③ While pushing [FUNC], push and hold [\*] to program the selected frequency.

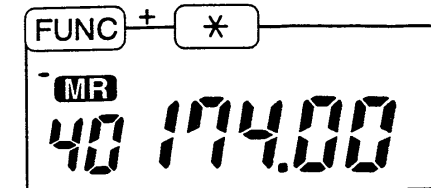
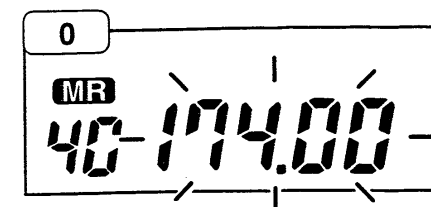
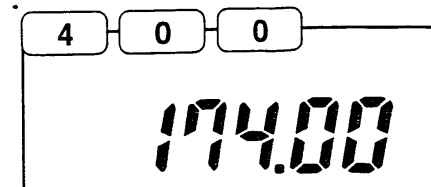
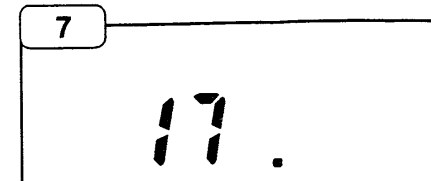
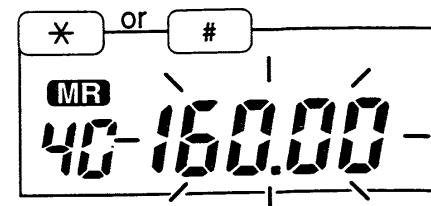

## ■ Tuning steps

Tuning steps should be selected to match the transceiver's area of operation. The following tuning steps are available:

5 kHz	10 kHz	12.5 kHz	15 kHz
20 kHz	25 kHz	50 kHz	100 kHz

To select a tuning step:

- ① While pushing [FUNC], push [5].
  - "tS" and the previously selected tuning step appears.
- ② Rotate [DIAL] to select the desired tuning step.
- ③ Push [FUNC] + [5] to return to normal operation.

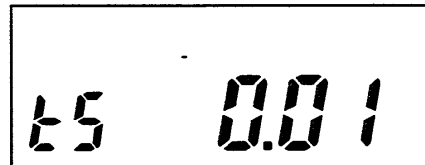

10 kHz step is selected

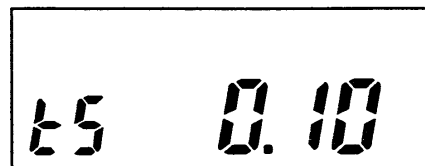

100 kHz step is selected

## ◇ 1 MHz tuning

When rotating [DIAL], 1 MHz tuning increments can be obtained by pushing the [FUNC] switch.

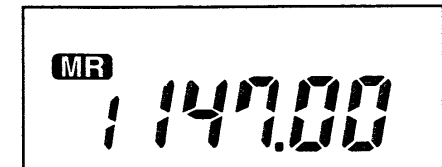
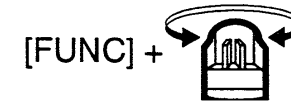

Frequency changes in 1 MHz steps

/// **NOTE:** If [FUNC] + [DIAL] changes the memory channel, push [FUNC] + [2] to activate MHz tuning.

## ■ Lock function

The lock function allows you to inhibit front panel key operation except for high/low power and manual DTMF operation.

Push [FUNC] + [A] to toggle the lock function ON and OFF.

Appears when the lock function is activated.

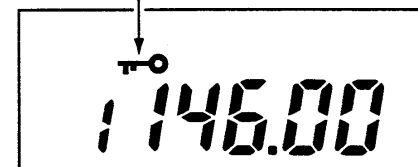

## 3 BASIC OPERATION

### ■ Memory channel selection

Push [✳] or [#] to select a memory channel.

When the display shows “160.00” and blinks, the contents are not programmed into the channel. The channel will not appear when channel indication mode is selected.

#### • Dial select function

While pushing [FUNC], rotate [DIAL] to change the memory channel.

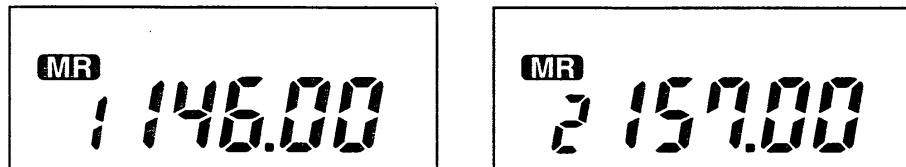
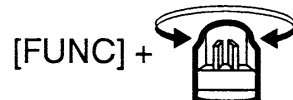

Memory channel changes

/// **NOTE:** If [FUNC] + [DIAL] changes the 1 MHz digit of the freq., push [FUNC] + [2] to activate the dial select function.

#### • Automatic ch 1 selection at power ON for channel indication mode

For channel indication mode the transceiver can be set for automatic selection of channel 1 at power ON.

In common set mode, set the second bit of item “F3” to 0.

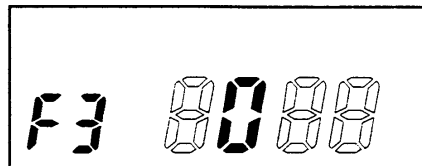

### ■ Memory write

- ① Select the memory channel to be programmed using [✳] or [#].
- ② Set the desired frequency using the keypad or tuning dial.
- ③ Set desired functions such as tone encoder, ANI, tuning step, etc.
- ④ While pushing [FUNC], push and hold [✳] to program the selected frequency.

### ■ Memory clearing

- ① Select the memory channel to be cleared using [✳] or [#].
- ② While pushing [FUNC], push and hold [#] to clear the channel.

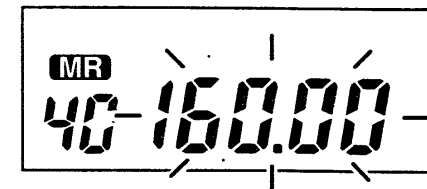

- The channel shows 160.00 and blinks.
- The channel will not appear when channel indication mode is selected.



## Receive and transmit

/// The following describes non-ANI operation. When you require ANI operation refer to pgs. 29 and 30 for details.

- ① Turn power ON and set the [VOL] control to the 10 to 12 o'clock position.
- ② Select the desired channel or frequency.
- ③ Received signals are emitted from the speaker.
  - Further adjustment of [VOL] may be necessary at this point.
- ④ Push and hold [PTT] to transmit.
  - The transmit/busy indicator lights red.
- ⑤ Speak into the microphone at a normal voice level.
  - DO NOT hold the transceiver too close to your mouth or speak too loudly. This may distort the signal.
  - Depending on programming, transmitting may not be possible when the transmit/busy indicator lights green.
- ⑥ Release [PTT] to return to receive.

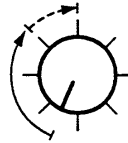

## Functions for receive

### ◆ Monitor function

The monitor function allows you to temporarily open the squelch and is particularly useful during repeater operation (p. 15).

Push [FUNC] momentarily, then immediately push and hold [FUNC] again to temporarily monitor a channel.

- All signals are received, including weak ones and those not directed to you specifically.
- The monitor function can be inhibited in common set mode: set the 3rd bit of item F1 to "0" to inhibit the monitor function; set to "1" to allow the monitor function.

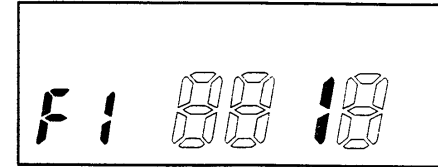

Monitor function available

### ◆ Power saver

During standby, the power saver function reduces the current drain for battery conservation. This function can be turned ON or inhibited in common set mode (p. 33). Note that even when turned ON in set mode it *does not* function during scan.

The power saver activates after the transceiver remains in the standby condition for 3 sec. and has a duty cycle of:  
circuit idle : circuit standby =  
1 sec. : 0.15 sec.

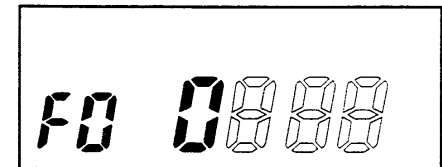

Power saver activates

Turn OFF the power saver function when the pager/code squelch or ANI function is in use. The power saver function may prevent proper reception of the connected signal.

## 3 BASIC OPERATION

### ■ Functions for transmit

#### ◇ Transmit inhibit

This function inhibits transmit on specified channels.

*To program this function:*

- ① Push [\*] or [#] to select a channel.
- ② Push [FUNC] + [8] to enter channel specific set mode.
- ③ Push [\*] or [#] to select the transmit inhibit condition.  
• “t i” appears.
- ④ Rotate [DIAL] to select the desired setting:  
ON: Transmit inhibit  
OFF: Transmit possible
- ⑤ Push [FUNC] + [8] to exit channel specific set mode.



#### ◇ Transmit inhibit while busy

This function electronically inhibits transmission while the transmit/busy indicator lights green (meaning a carrier signal is present).

*To program this function:*

- ① Push [\*] or [#] to select a channel.
- ② Push [FUNC] + [8] to enter channel specific set mode.
- ③ Push [\*] or [#] to select the transmit inhibit condition.  
• “t i” appears.
- ④ Rotate [DIAL] to select the desired setting:  
ON: Transmit inhibit while busy  
OFF: Transmit possible even while busy
- ⑤ Push [FUNC] + [8] to exit channel specific set mode.



◇ **Time-out timer**

This function automatically returns the transceiver to receive after a pre-set period of continuous transmission. This is useful to prevent accidental, continuous transmissions for long periods. The time-out timer can be set from 30 sec. to 7 min. 30 sec. and OFF (time-out timer will not activate). This function can be adjusted in common set mode (p. 33).

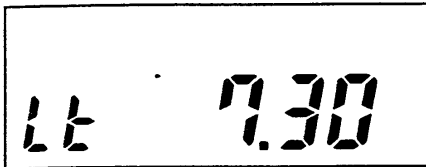

/// **NOTE:** A separate time-out timer function is available for ANI operation. See item "F7" in common set mode on p. 37 for details.

◇ **Setting output power**

Output power can be set to high (5 W) or low (500 mW). Push [B] to toggle between the two output powers.

- "LOW" appears when low output power is selected.
- During channel indication mode, output power selection may be inhibited. See below.

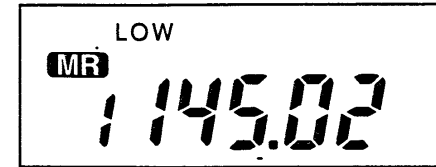

• **Power selection during channel indication**

Power selection during channel indication mode can be inhibited in common set mode (p. 35).

The display at right shows that power selection is allowed during channel indication (default).

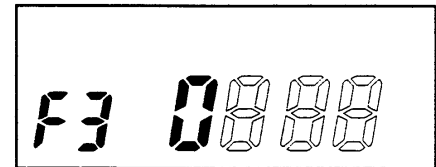

## ■ Pre-setting

In order to use the subaudible tone encoder and/or decoder with scrambler functions, the optional UT-86 (without scrambler) or UT-88 must be installed and selected in common set mode.

*To select the tone unit for subaudible tone operation:*

- ① Push [FUNC] + [0], then push [\*] or [#] to select the common set mode item "F0."
- ② Set the second bit to "1" for optional tone unit if installed.
- ③ Push [FUNC] + [0] to return to normal operation.

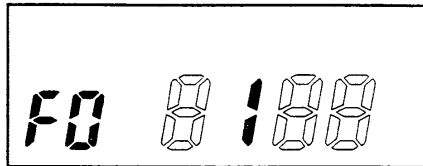

*To activate the scrambler switch function during channel indication:*

- ① Push [FUNC] + [0], then push [\*] or [#] to select the common set mode item "F4."
- ② Set the second bit to "0" for optional voice scrambler ON/OFF capability or set to "1" for ON/OFF switch inhibit during channel indication.
- ③ Push [FUNC] + [0] to return to normal operation.

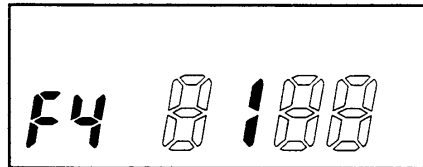

## ■ Setting the tone encoder

The tone encoder can be used independently for each channel.

- ① Push [FUNC] + [8] to enter channel specific set mode, then push [\*] or [#] until "tt" appears (for transmit tone).

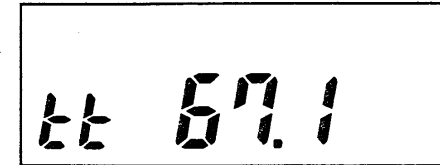

- ② Rotate the dial to select a tone frequency (see p. 17 for available tone frequencies).

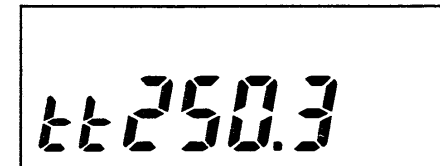

- ③ Push [FUNC] + [8] to return to regular operating mode.

- ④ Program the selected tone frequency into a channel.

- Push [FUNC] + [1], once or twice to select the tone encoder (♪) or tone squelch (♪((♯))).

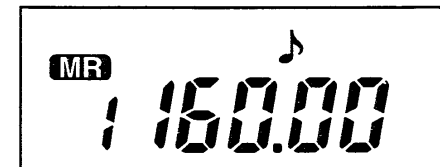

- Be sure the tone decoder frequency is set separately when using the tone squelch.
- Push [FUNC] + [\*] for 1 sec. to program.

# 4

## REPEATER OPERATION

### ■ General

When using a repeater, your transmit frequency is shifted from your receive frequency by the offset frequency. It is convenient to program repeater information into memory channels.

- ① Set the receive frequency (or select a channel).
- ② Push [FUNC] + [4] once or twice to select + or – semi duplex.
  - To change the offset frequency, see right.
- ③ Push [FUNC] + [1] to activate the subaudible tone encoder, according to repeater requirements (p. 16).
  - “♪” appears.
  - To change the tone frequency, see page opposite.
- ④ Push and hold [PTT] to transmit.
  - The displayed frequency automatically changes to the transmit frequency (repeater input frequency).
- ⑤ Release [PTT] to receive.
- ⑥ Push [FUNC] momentarily, then immediately push and hold [FUNC] again to activate the monitor function (p. 12) and check whether the other station’s transmit signal can be directly received or not.
- ⑦ If frequency, offset and tone settings need to be programmed, push [FUNC] + [\*] for 1 sec.

### ■ Setting offset frequencies

Offset frequencies can be programmed independently for each channel.

- ① Push [FUNC] + [8] to enter channel specific set mode.
  - An offset frequency appears.

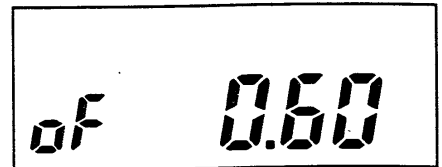

- ② Rotate [DIAL] to select the desired offset frequency (0 to 99.9950 MHz).

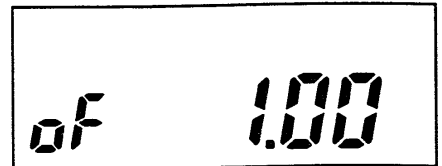

- The frequency changes according to the selected tuning step.
  - Pushing [FUNC] while rotating [DIAL] changes the frequency in 1 MHz steps.
- ③ Push [FUNC] + [8] to return to regular operating mode.

- ④ Program the selected offset into the channel.

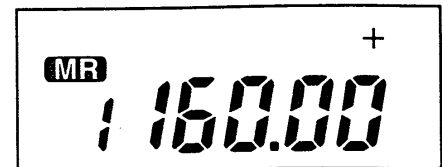

- Push [FUNC] + [4], once or twice, to select + or – semi duplex.
- Push [FUNC] + [\*] for 1 sec. to program.

## 5 SUBAUDIBLE TONE AND SCRAMBLER

### ■ Setting the tone decoder

Like the tone encoder, the tone decoder can be used with the tone squelch independently for each channel.

- ① Push [FUNC] + [8] to enter channel specific set mode, then push [\*] or [#] until "rt" appears (for receive tone).

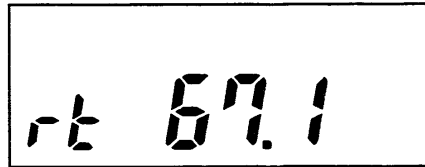

- ② Rotate the dial to select a tone frequency (see table at right for available tone frequencies).

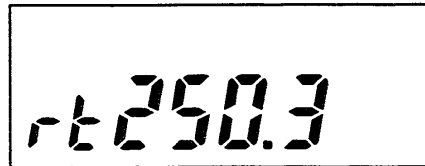

- ③ Push [FUNC] + [8] to return to regular operating mode.

- ④ Program the selected tone frequency into a channel.

- Push [FUNC] + [1] twice to select the tone squelch (♪ (Ⓜ)).
- Be sure the tone encoder frequency is set separately when using the tone squelch.
- Push [FUNC] + [\*] for 1 sec. to program.

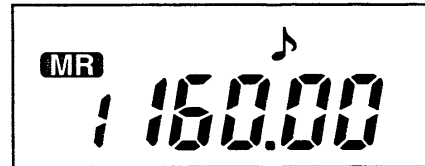

### ◇ Available tone frequencies (unit: Hz)

67.0	82.5	97.4	114.8	136.5	162.2	192.8	233.6
71.9	85.4	100.0	118.8	141.3	167.9	203.5	241.8
74.4	88.5	103.5	123.0	146.2	173.8	210.7	250.3
77.0	91.5	107.2	127.3	151.4	179.9	218.1	
79.7	94.8	110.9	131.8	156.7	186.2	225.7	

## ■ Tone squelch and voice scrambler operation

### ◇ Tone squelch operation

The tone squelch opens only when receiving a signal containing a matching subaudible tone. You can silently wait for calls from group members using the same tone.

- ① Check the following:
  - An optional UT-86 or UT-88 is installed.
  - The installed tone unit is activated (p. 16, upper left).
  - Tone encoder and decoder frequencies are set separately (pgs. 16, 17).
- ② Set the operating frequency (or select a memory channel).
- ③ While pushing [FUNC], push [1] twice to activate the tone squelch.
  -  appears.
- ④ Operate the transceiver in the normal way.
- ⑤ To cancel the tone squelch, push [FUNC] + [1]; or, to program the tone squelch function to the selected channel, push and hold [FUNC] + [\*] for 1 sec.

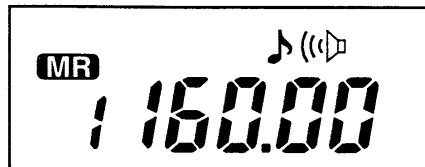

### ◇ Voice scrambler operation

The voice scrambler provides private communications since your transmitted audio is scrambled and other transceivers cannot demodulate the signals; only those which have the same scrambler unit can.

- ① Check the following:
  - An optional UT-88 is installed.
  - For channel indication use, set the scramble function switch to permitted.
  - Tone encoder and decoder frequencies are set separately (pgs. 16, 17)
- ② Set the operating frequency (or select a memory channel).
- ③ While pushing [FUNC], push [7] to toggle the function ON and OFF.
  -  appears when the function is activated.
- ④ Operate the transceiver in the normal way.
- ⑤ To cancel the voice scrambler, push [FUNC] + [7]; or, to program the scrambler function for the selected channel, push [FUNC] + [\*] for 1 sec.

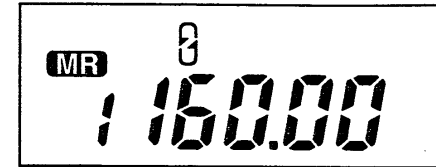

## ■ Noise mute function

Normally, the moment a signal disappears, audio noise is emitted as the squelch is closed. When using an optional tone squelch unit, this noise can be eliminated.

- ① Push [FUNC] + [0], then push [\*] or [#] to select the common set mode item "F1."
- ② Set the fourth bit to "0" activate the noise mute function.
- ③ Push [FUNC] + [0] to return to normal operation.

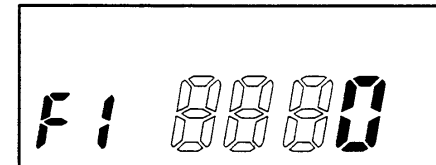

## ■ Programming a DTMF code

- ① Push [FUNC] + [D] to enter DTMF code set mode.
- A DTMF channel appears.

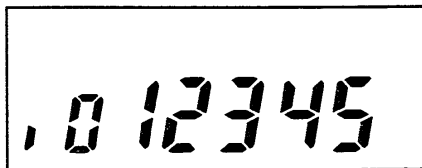

- ② Rotate [DIAL] to select the desired DTMF channel, 0 to 9.

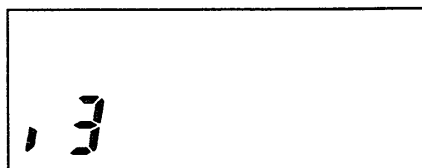

- ③ Push the corresponding keys for the desired DTMF code in sequence.
- Up to 16 digits can be input.

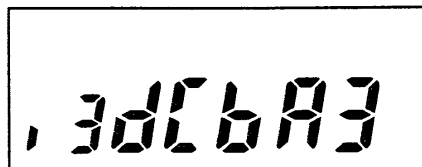

- ④ Push [FUNC] + [\*] to program the DTMF code into the selected channel.
- ⑤ Repeat steps ② to ④ to program additional channels or push [FUNC] + [D] to exit DTMF code set mode.

### NOTE:

- Pushing [FUNC] + [\*] before inputting digits will clear any previously programmed DTMF contents.
- When inputting the maximum 16 digits, DO NOT push [FUNC] + [\*], otherwise the contents will be cleared.
- Pushing [FUNC] + [D] before pushing [FUNC] + [\*] exits DTMF code set mode without changing the contents.

- The character at the bottom left of the DTMF code set mode display indicates the range of digits being viewed:
  - ! digits 1 to 5
  - ∩ digits 6 to 10
  - ∩ digits 11 to 15
  - ∩ digit 16 only

## ■ Transmitting a DTMF code

### ◇ Manual transmission

While pushing [PTT], push one of the keys to transmit the corresponding DTMF code sequentially.

- This function can be inhibited in common set mode (p. 34).

### ◇ DTMF memory transmission

DTMF memory channels, when programmed, can be transmitted instantly.

To transmit a DTMF memory, push [D], then push one of the digit keys (0–9) within 2 sec.

- The corresponding DTMF memory channel is automatically transmitted.

While “d” appears, push the desired DTMF memory channel number. The DTMF tones can be heard as they are transmitted.

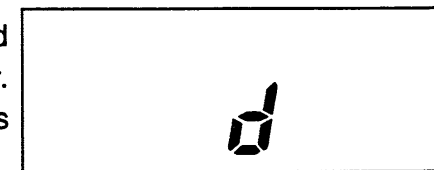



## ■ Function restrictions for channel indication mode

Using common set mode, several DTMF-related functions can be restricted during channel indication.

- ① Push [FUNC] + [0], then push [\*] or [#] to select a common set mode item.
- ② Set the appropriate bit value.
- ③ Push [FUNC] + [0] to return to normal operation.

Manual DTMF transmission during channel indication

- "0" OK (default)  
"1" inhibited

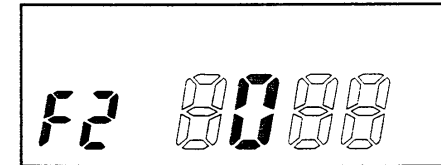

DTMF memory overwrite during channel indication

- "0" OK  
"1" inhibited (default)

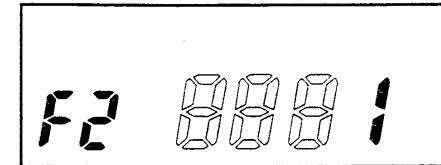

Entering DTMF set mode during channel indication

- "0" OK (default)  
"1" inhibited

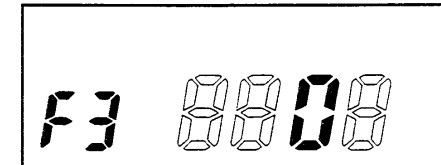

DTMF memory operation during channel indication

- "0" OK (default)  
"1" inhibited

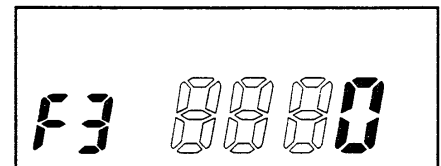

## ■ Scan types

There are 2 scan types available. Before activating the scan function, program the desired scan type in common set mode (p. 33).

### ◇ Empty scan

Channels are searched in sequence and scan pauses on unoccupied (empty) channels.

- If no signal appears within 2 seconds after pausing, scan is cancelled.
- If a signal appears within 2 seconds after pausing, scan resumes.

### ◇ Busy scan

Channels are searched in sequence and scan pauses on occupied (busy) channels.

- If the channel remains busy for 3 seconds, scan resumes.
- If the signal disappears, scan resumes 2 seconds after that.

## ■ Pre-settings

### ◇ Turning the scan function ON/OFF during channel indication

The scan function can be inhibited during operation in channel indication mode.

- ① Push [FUNC] + [0] to enter common set mode; then, push [✳] or [#] one or more times until "F4" is selected.

- ② Rotate [DIAL] to set the 3rd bit.

- "0" indicates scan can be used (default); "1" indicates scan is inhibited.

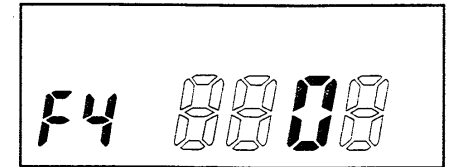

### ◇ Selecting the scan type

- ① Push [FUNC] + [0] to enter common set mode; then, push [✳] or [#] one or more times until "F0" is selected.

- ② Rotate [DIAL] to set the 3rd bit (for scan type).

- "0" indicates busy scan is selected; "1" indicates empty scan is selected.

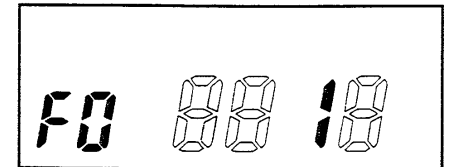

/// **NOTE:** During ANI operation, scan functions as busy scan regardless of the scan type chosen in common set mode.

## ■ Scan start/stop

Push [FUNC] + [B] to toggle scan ON and OFF.

- During scan “MR” flashes and the memory channel and frequency readouts are searched for signals.

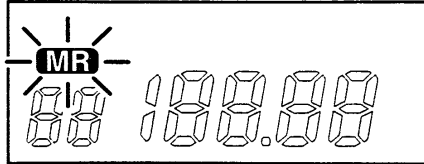

- When transceiver power is turned OFF during scan operation, scan resumes when power is turned ON again.

## ■ Setting skip channels

Channels which are not necessary to scan may be programmed as skip channels. This is useful for speeding up the scan interval and avoiding pauses on unwanted channels.

- ① Select the desired channel to be skipped.
- ② Push [FUNC] + [6] to toggle the skip function ON and OFF for the selected channel.
  - “SKIP” appears when the channel is programmed as a skip channel.
- ③ Push [FUNC] + [\*] for 1 sec. to program the skip setting to the selected channel.



## ■ Pager function

This function uses DTMF codes for paging and can be used as a “message pager” to inform you of a caller’s identity even when you leave the transceiver temporarily unattended.

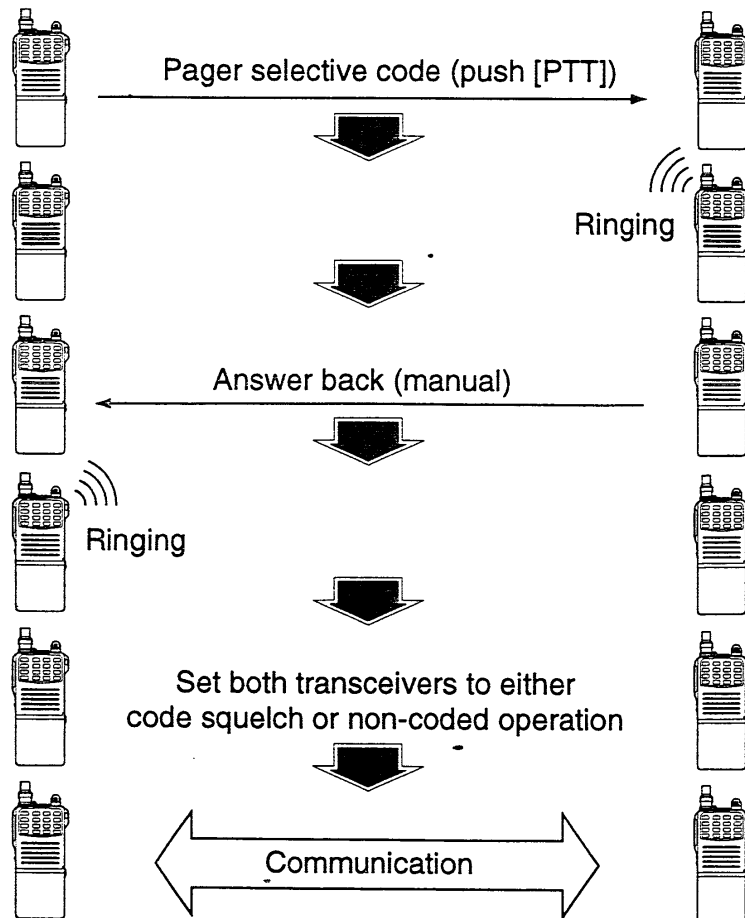

## ■ Code programming

### ◇ Before programming

The pager and code squelch functions require ID codes and a group code. These codes are 3-digit DTMF codes and must be written into the code channels before operation.

- ① Decide the ID code of each transceiver and a group code for your group.
- ② Decide whether you want to return to normal operation or code squelch operation after a connection is made.
- ③ Program the ID code, group code and transmit codes (other station’s ID codes) as below.

### ◇ Code channel assignment

ID OR GROUP CODE	CODE CHANNEL NUMBER	“RECEIVE ACCEPT” OR “RECEIVE INHIBIT”
Your ID code	0	“Receive accept” only.
Other parties’ ID code	1–6	“Receive inhibit” should be programmed in each channel.
Group code	One of 1–6	“Receive accept” must be programmed.
Memory space*	P	“Receive inhibit” only.

\*Channel CP automatically memorizes an ID code when receiving a pager call. The contents in channel CP cannot be changed manually.

### ◇ Code programming

An ID code **MUST** be programmed into code channel C0. Up to 6 transmit codes are programmable into code channels, C1 to C6, if required.

- ① Push [FUNC] + [C] to enter code set mode.
  - One of “CP,” or “C0” to “C6” appears.
  - “C0” is the ID code and “C1” to “C6” are transmit codes.

- ② Rotate [DIAL] to select code channel C0.

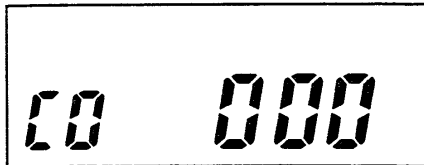

- A different ID code **MUST** be programmed into each transceiver.

- ③ Push 3 digit keys to set the desired ID code.

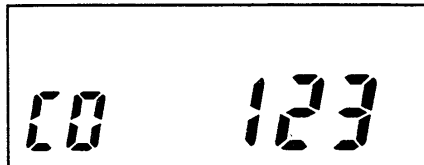

- Group code “D” cannot be programmed.

- ④ Rotate [DIAL] to select a transmit code channel from C1 to C6.

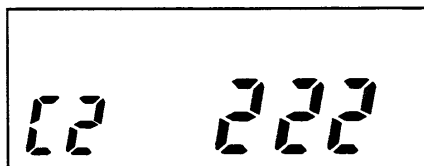

- ⑤ Push 3 digit keys to set the desired transmit code.

- ⑥ Push and hold [FUNC] + [C] to set the channel for “receive inhibit” or “receive accept.”

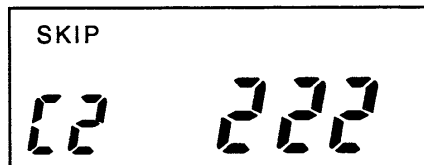

- When “receive inhibit” is set, “SKIP” appears as above.

- Code channel C0 cannot be set as “receive inhibit.”
- See table below for “receive accept” and “receive inhibit” details.
- ⑦ Repeat steps ④ and ⑤ to set additional transmit code channels, if desired.
- ⑧ Push [FUNC] + [C] or [PTT] to exit code set mode.

### • Receive accept/receive inhibit

- “Receive accept” (“SKIP” indicator does not appear) accepts pager calls when the transceiver receives a signal with a code the same as that in the code channel.
- “Receive inhibit” (“SKIP” indicator appears) rejects calls even when the transceiver receives a code the same as that in the code channel. Transmit codes should therefore be programmed for “receive inhibit,” otherwise the transceiver will not reject unnecessary calls.

▨ **NOTE:** This receive accept/inhibit setting is effective for pager and code squelch and does not affect the ANI function.

- **Pager/code squelch operation during channel indication**  
To use these functions in channel indication, the F0 display’s 4th bit must be set to “0.” See p. 33 for details.

---

## 8 PAGER AND CODE SQUELCH

### ■ Pager operation

#### ◇ Calling a specific station

- ① Program the needed code channel in advance (p. 24).
- ② Set the operating frequency (or select a memory channel).
- ③ Push [C] one or more times to turn the pager function ON, if necessary.
  - “” appears.
- ④ Select the desired transmit code channel:
  - ➔ Push [FUNC] + [C].
  - ➔ Rotate [DIAL] to select the desired code.
  - ➔ Push [FUNC] + [C] to exit the setting display.
- ⑤ Push [PTT] to transmit the pager code.
- ⑥ Wait for an answer back.
  - When the transceiver receives an answer back code, the function display shows the other member's ID or group code.
- ⑦ After confirming a connection push [C] once to select the code squelch or twice to select the non-selective calling system.
  - DO NOT push any digit keys while code channels C0 to C6 are displayed, or code channel contents are changed.
- ⑧ Communicate with the other party as normal: push [PTT] to transmit; release to receive.

#### ◇ Waiting for a call from a specific station

- ① Set the operating frequency (or select a memory channel).
- ② Push [C] once or twice to turn the pager function ON.
  - “” appears.
- ③ Wait for a call.
  - When receiving a call, the caller's ID or group code appears as shown at right.
  - DO NOT push any digit keys while code channels C0 to C6 are displayed, or code channel contents are changed.
- ④ Push [PTT] to send an answer back call and display the operating frequency.
- ⑤ Push [C] once to select the code squelch or twice to select the non-selective calling system.

**PERSONAL CALLS**

This display appears when you are called with your ID code and the calling station's ID code is 123.

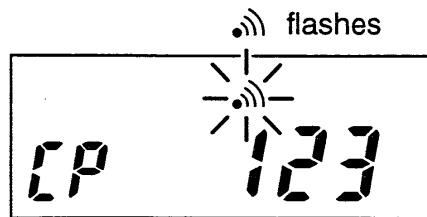
**GROUP CALLS**

This display appears when you are called with the group code, 888, and 888 has been programmed into code channel C6.

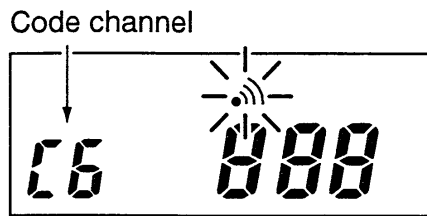
**ERROR INFORMATION**

When the transceiver receives an incomplete signal, "EP" and "Edd" appear.

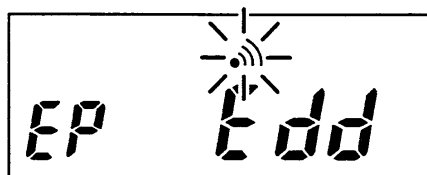
**Code squelch**

Code squelch provides communications with quiet standby since you will only receive calls from stations which know your ID or group code. Each push of [PTT] sends a 3-digit code in order to open the receiving station's code squelch prior to voice transmission.

- ① Set the operating frequency (or select a memory channel).
- ② Push [C] one or more times until "▲" appears, if necessary.

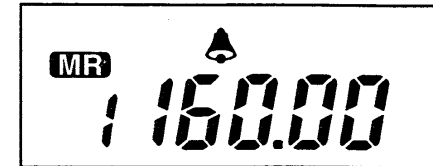

- ③ Select the desired transmit code channel:
  - ➔ Push [FUNC] + [C].
  - ➔ Rotate [DIAL] to select the desired code.
  - ➔ Push [FUNC] + [C] to exit the setting display.

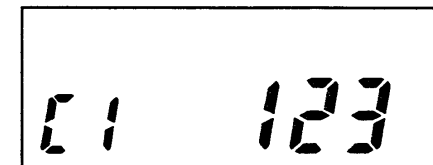

- ④ Operate the transceiver in the normal way (push [PTT] to transmit; release [PTT] to receive).
- ⑤ To cancel the code squelch, push [C]; or program the function into the selected channel, push [FUNC] + [\*] for 1 sec.
  - "▲" disappears when the function is cancelled.

## ■ Function description

The ANI function is only available during channel indication (see below). ANI provides selective calling and features an answer back function. This allows you to confirm whether or not a call has reached the receiving party even if the operator is temporarily away from the transceiver.

### ◇ Mode selection

Channel indication mode and frequency indication mode can be toggled as illustrated below (see also p. 41).

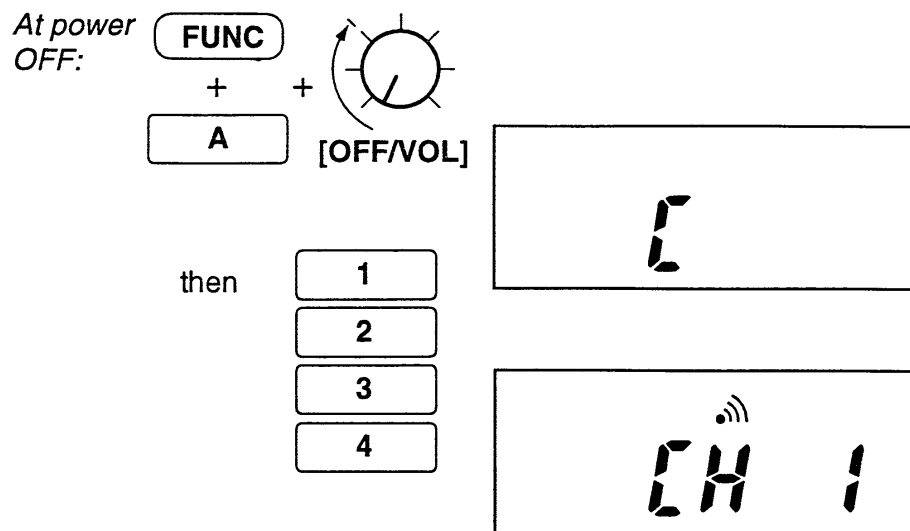

**NOTE:** In channel indication mode only pre-programmed channels are selectable and frequencies cannot be input. Also, selectable functions depend on programming in common set mode (p. 33).

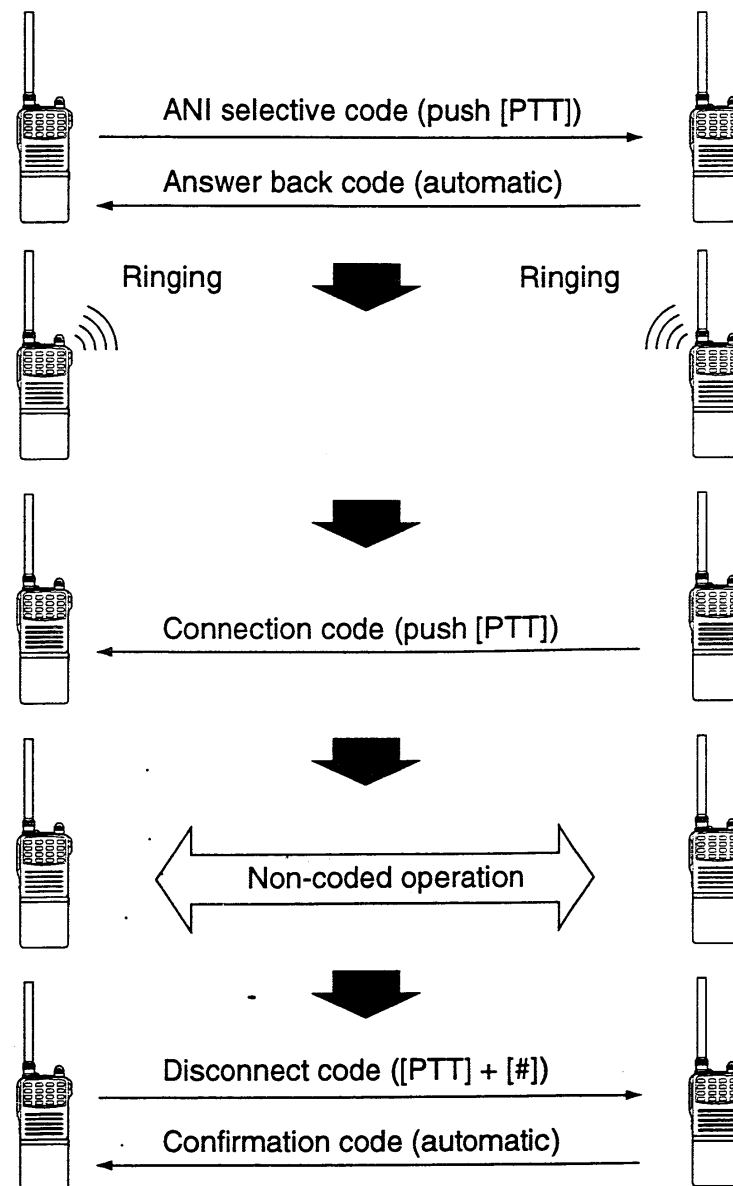



## ■ Preparation

① Select frequency indication mode (see page at left).

② Enter common set mode and make sure the setting allows ANI use (p. 33).

- Push [FUNC] + [0].
- Rotate [DIAL] to set the 4th bit of "F0."
- "1": ANI operation.
- "0": pager/code squelch

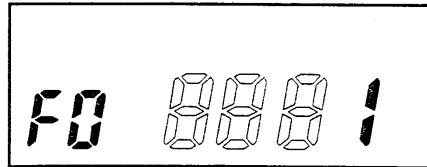

③ Program your ID and the destination ID.

- Set your ID into channel C0 and destination ID's into channels C1 to C6.
- Push [FUNC] + [C], set the channel with [DIAL], then input 3 digits.
- Push [FUNC] + [C] again to exit.

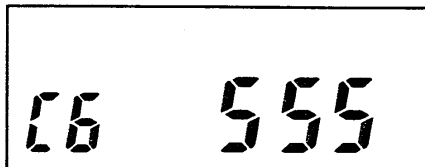
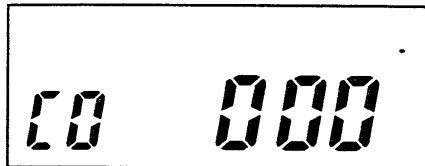

④ Select the memory channel and its frequency for using the ANI function.

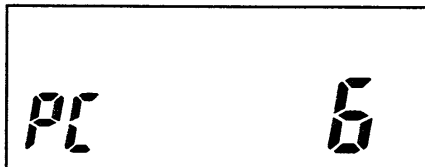

⑤ Turn the ANI function ON.

- Push [C] once to indicate "📶."

⑥ Assign the transmit code.

- Push [FUNC] + [8], then push



[#] to indicate the "PC" display.

- Rotate [DIAL] to select the code channel where the desired destination ID is programmed.

⑦ Program the setting into the selected channel.

- Push [FUNC] + [\*] for 1 sec.

⑧ Program other channels in the same manner as steps ④ to ⑦.



⑨ Select the pager code memory overwrite during channel indication acceptance.

- Push [FUNC] + [0].
- Push [#] to select the F2 display.
- Rotate [DIAL] to set the 1st bit:
  - "0": transmit allowed.
  - "1": transmit inhibited.

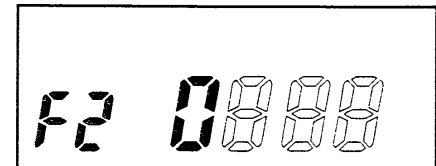

⑩ Set the transceiver to channel indication mode.





- While pushing [FUNC] + [A], turn power ON.
- Enter [1], [2], [3] and [4] via the keypad.



## 9 ANI FUNCTION

### ■ Operation (in channel indication mode)

#### ◇ Calling a specific station

- ① Turn power ON and set the [VOL] control to the 10 or 12 o'clock position.
- ② Rotate the [DIAL] to set the desired channel.
  - “” appears on ANI usable channels.
- ③ Push [PTT] once to connect to the selected station.
  - The transceiver transmits the pre-programmed selective code.
  - To use another selective code, see right “Using other selective codes.”
- ④ When the transceiver rings (an answer back is received), wait for a connection code from the connected station; when the transceiver doesn't ring, push [PTT] again to exit the standby condition, then try again from step ③ after waiting awhile.
- ⑤ When the connection code is received, a beep sounds, then “” flashes; when the connection code is not received within 15 sec., the transceiver transmits a disconnect code automatically (“” does not flash). Try again from step ③ after waiting awhile, in such a case.
- ⑥ While “” flashes, you can converse with the connected station.
  - Push to transmit; release to receive.



- ⑦ When your conversation is finished, transmit the disconnect code.
  - While pushing [PTT], push [#].
  - Some transceivers cannot transmit a disconnect code depending on programming.

/// **NOTE:** When your conversation extends into the ANI timeout time, the transceiver transmits a disconnect code automatically.

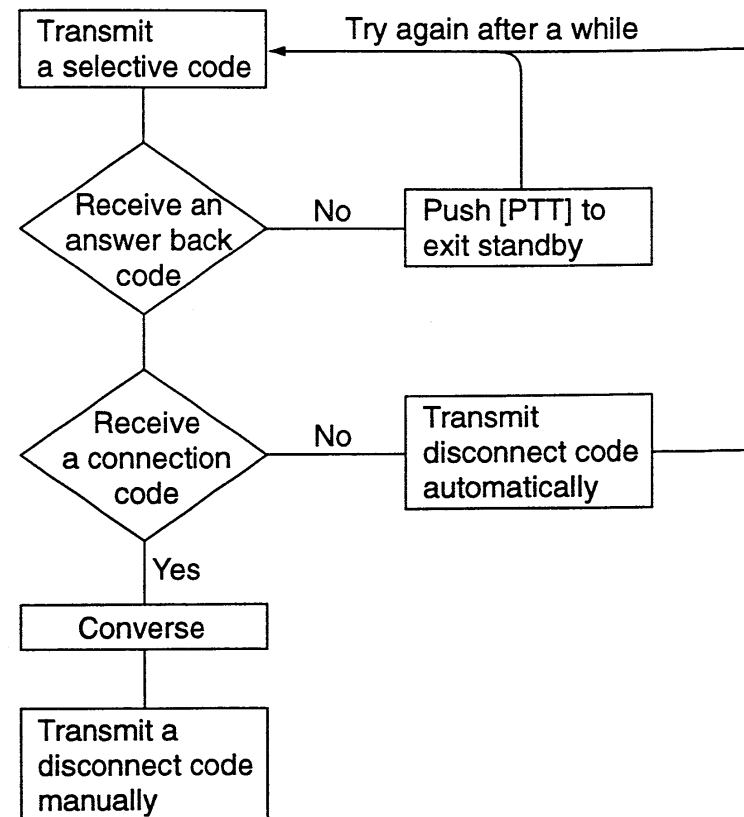

### ◇ Calling group stations

- ① Turn power ON, then select the desired ANI setting channel.
- ② Push [C], then input 3 digits for the desired stations group, including [D] at least once, to transmit a group code.
  - When making group calls the transceiver does not ring and no answer back connection code is received.
  - You can make an announcement to your group immediately without a connection procedure.
- ③ Use [PTT] in the regular way to communicate.
- ④ When your conversation is finished, while pushing [PTT], push [#] to transmit a disconnect code.

### ◇ Group call code examples

#### [Example 1]

If "11D" is transmitted, transceivers with receive codes "110" to "119" are called.

#### [Example 2]

If "1D3" is transmitted, transceivers with receive codes "103," "113," ... "183" and "193" are called.

/// **NOTE:** "DDD" transmits to all transceivers.

### ◇ Using other selective codes

#### • Using pre-programmed codes

Preprogrammed code channels can be selected depending on settings. The code channel returns to its original settings when changing the operating channel after turning power OFF.

- ① Push [FUNC] + [C] to indicate the code channel.

- ② Rotate [DIAL] to select the desired channel.
- ③ Push [PTT] to transmit the selected code, or push [FUNC] + [C] to return to the previous display.

#### • Using direct input

A selective ID can be transmitted via the keypad.

Push [C], then input 3 digits for the desired station.

- The selected call is automatically transmitted.

### ◇ Waiting for a call

- ① Turn power ON, then set the [DIAL] to the desired ANI setting channel (or start scan).
- ② When you receive a selective call, the display changes as at right, then a "ringing" is heard.

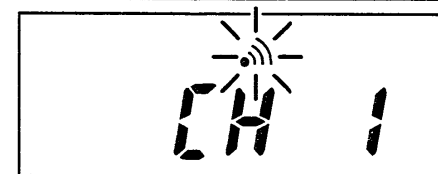
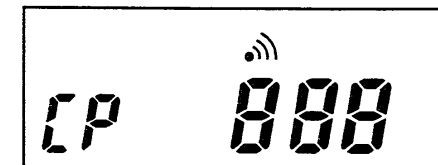
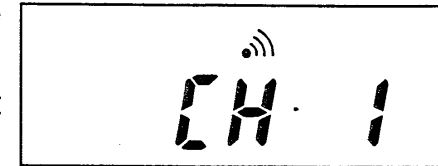

- ③ Push [PTT] to send a connection code within 15 sec.
- ④ While "📶" flashes, converse with the connected station.
- ⑤ When your conversation is finished, you may receive a disconnect code.
  - Transmitting the disconnect code from your side (push [PTT] + [#]) is also possible (except for group call receive).
  - "📶" stops flashing.

## 9 ANI FUNCTION

### ■ Other settings for ANI operation

These can only be made while in frequency indication mode.

#### ◇ Code memory indication

ANI code channels can be selected during channel indication. Push [FUNC] + [0] to display the 4th bit of F4.

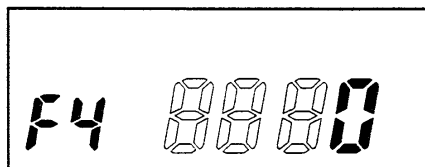

0: display and select  
1: DO NOT display

#### ◇ Code memory overwrite

ANI codes can be programmed during channel indication. The 1st bit of F4 must be set to "0" to allow this (above).

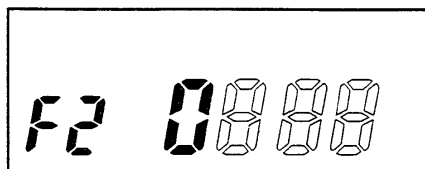

0: overwrite possible  
1: overwrite inhibited

#### ◇ Time-out timer during ANI operation

In common set mode, item F6 is used to set the time-out timer for ANI operation. See the table opposite. Default is "1111"—time-out timer turned OFF.

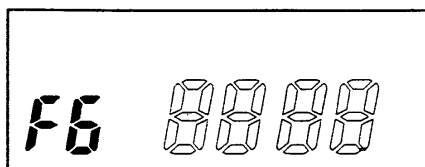

Bit Combination	Time-out Time (min.)	Bit Combination	Time-out Time (min.)
0000	1	1000	9
0001	2	1001	10
0010	3	1010	11
0011	4	1011	12
0100	5	1100	13
0101	6	1101	14
0110	7	1110	15
0111	8	1111	no limit

#### ◇ Scan function

To receive selective calls, the transceiver has a scan function. Push [FUNC] + [B] to start/stop scan.

0: scan is allowed  
1: scan is inhibited

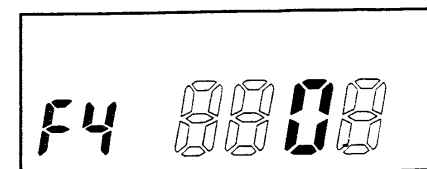

#### ◇ Code transmit delay time

When scanning is used for waiting stations, a transceiver should have a long carrier transmit period before sending a selective code. Bit 2 of the F2 display sets the period.

0: 500 msec. (for non-scanning)  
1: 3 sec. (for scanning)

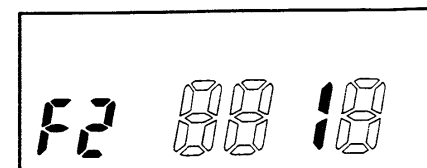

## ■ Reversing the display

This function rotates the channel indication (only) in the function display 180° and is convenient for viewing the transceiver from the top when it is attached to your belt.

Push [FUNC] + [9] to reverse the function display.

- Repeat the above step to return the display to normal.

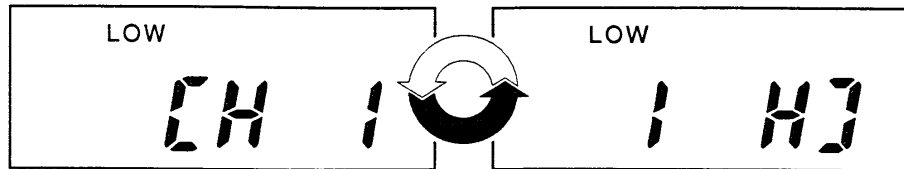

## ■ Confirmation beeps

Confirmation beeps sound when a key is pushed. These can be toggled OFF and ON.

- ① Push [FUNC] + [0], then push [\*] or [#] to select the common set mode item "F1."
- ② Set the second bit to "0" to turn confirmation beeps ON; set to "1" to turn confirmation beeps OFF.
- ③ Push [FUNC] + [0] to return to normal operation.

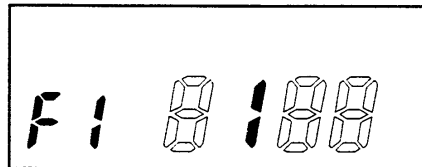

## ■ Display lighting

### ◇ 5 sec. timer

Push [A] momentarily to turn the display lighting ON. After 5 sec. of inactivity (in which no keys are pushed) the lighting automatically turns OFF.

### ◇ Continuous lighting

Push [A] for 2 sec. to turn the display lighting ON continuously. To turn the lighting OFF, push [A] momentarily.

- To conserve battery power, turn the lighting OFF when not needed.

## ■ CPU resetting

/// **CAUTION:** Resetting the CPU clears all channel data and initializes all programmed contents to their initial values.

/// **NOTE:** The CPU can only be reset when in frequency mode.

*To reset the CPU:*

While pushing [FUNC] + [#], turn power ON.

- All LCD segments appear momentarily and the CPU is reset.

# 11 COMMON SET MODE

## ■ General

Common set mode is used to set functions common to all channels. This mode consists of 9 items, F0 to F7 and Lt. Items consist of 4 “bits” and each bit can have a value of “1” or “0.” By setting the bit combinations for these, the transceiver can be programmed for various functions.

To enter common set mode:

- ① During frequency indication, push [FUNC] + [0].
  - Item F0 is selected.

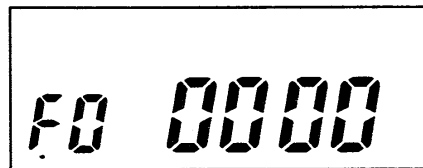

- ② Push [\*] or [#] to select the item desired.

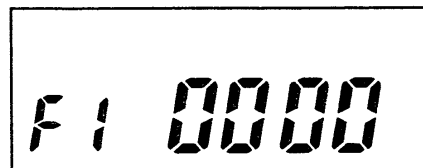

- ③ Rotate [DIAL] to select the bit combination and related item.

- The remaining pages of this chapter detail each available item and bit combinations.

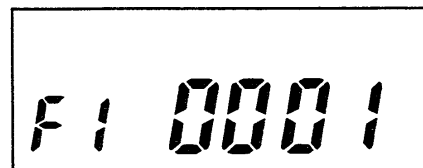

## ■ Item descriptions

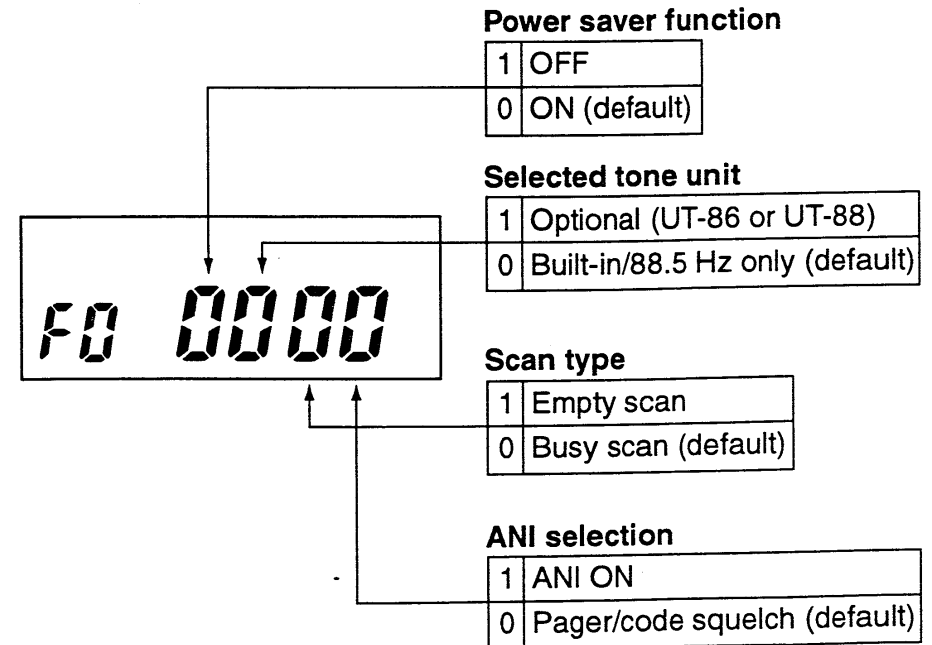

# 11 COMMON SET MODE

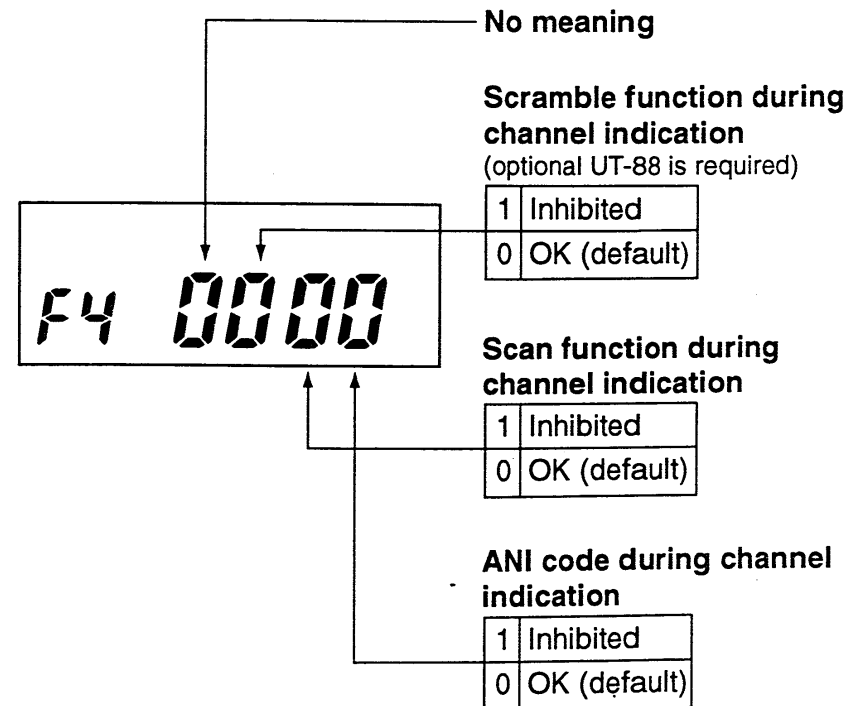
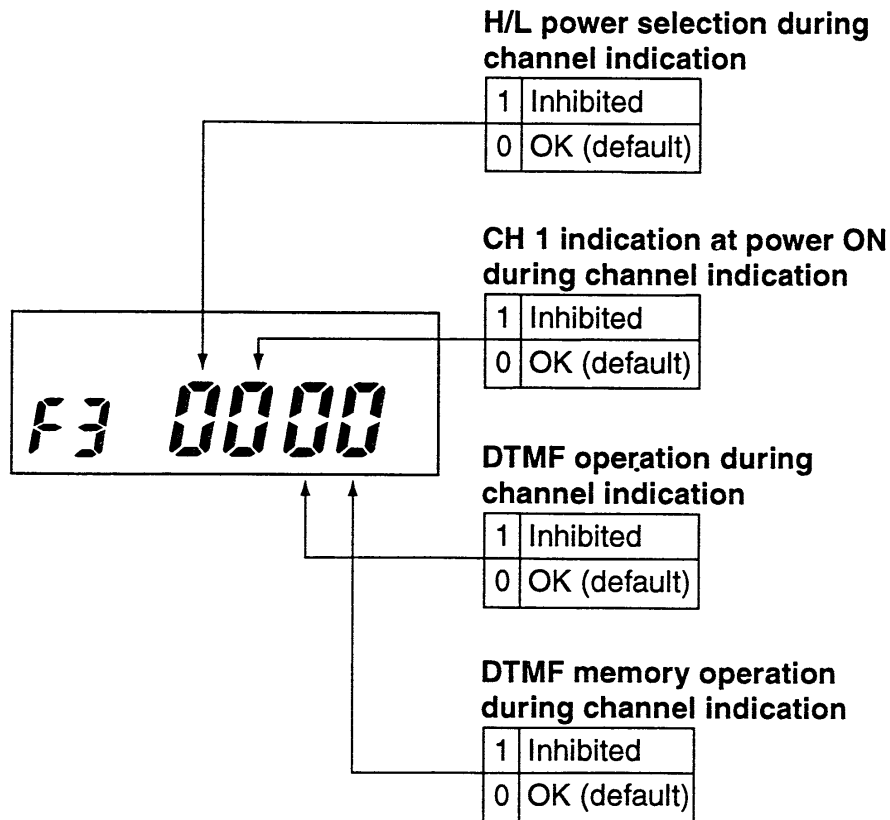

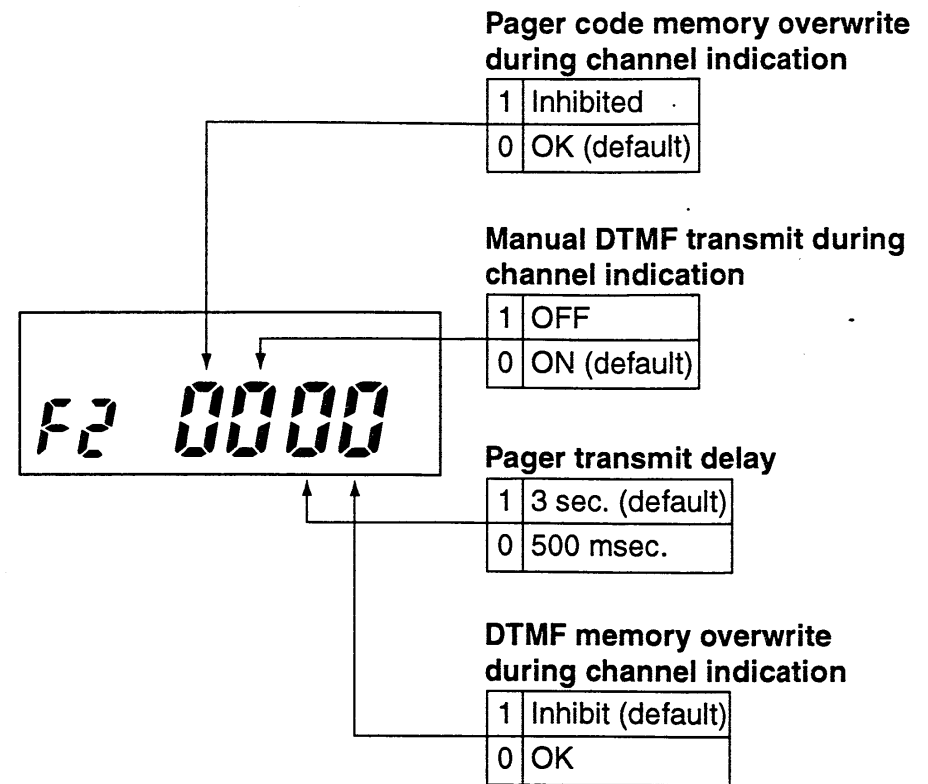
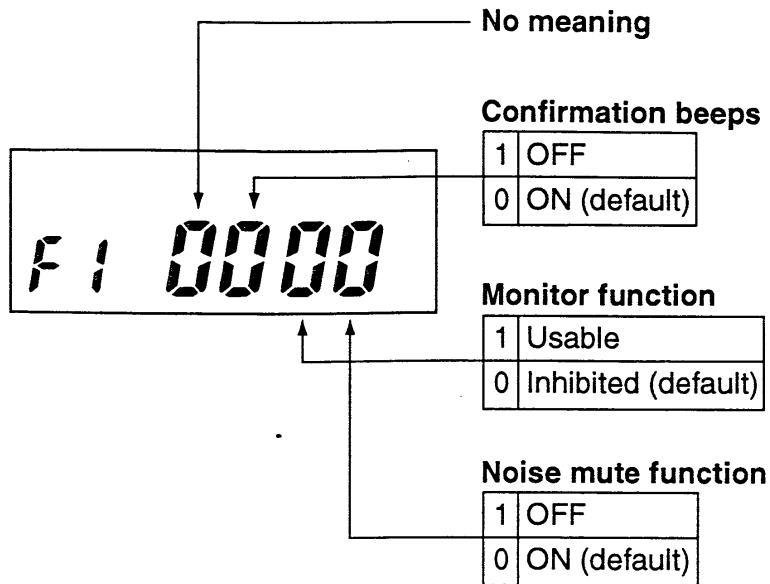



Manual opening of noise squelch while adjusting sensitivity

1	OK (default)
0	Inhibited

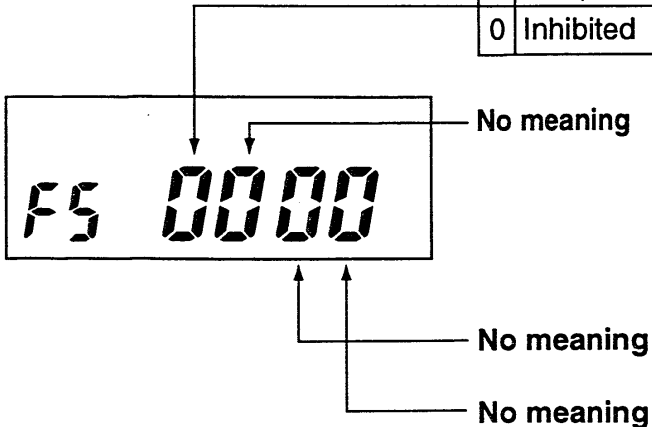

TOT during ANI operation  
(Default is 1111 : No time-out period set)

This item is used to adjust the time-out time period during ANI operation.

Bit Combination	Time-out Time (min.)	Bit Combination	Time-out Time (min.)
0000	1	1000	9
0001	2	1001	10
0010	3	1010	11
0011	4	1011	12
0100	5	1100	13
0101	6	1101	14
0110	7	1110	15
0111	8	1111	no limit

**NOTE:** This setting has no effect when ANI mode is not being used.  
When a user requires group call capabilities, set the ANI time-out timer to the same period for all transceivers in the group. Otherwise, the disconnect code may not function properly.

# 11 COMMON SET MODE



**Squelch delay during pager operation**  
(Default is 0010 : 3 seconds)

This item is used to adjust the time from when the noise squelch closes (after a receive signal disappears) to when the DTMF squelch opens.

Bit Combination	Delay (sec.)	Bit Combination	Delay (sec.)
0000	1	1000	9
0001	2	1001	10
0010	3	1010	11
0011	4	1011	12
0100	5	1100	13
0101	6	1101	14
0110	7	1110	15
0111	8	1111	16

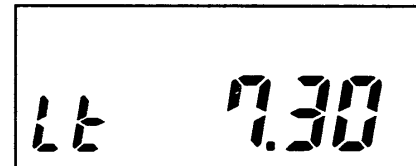

**TOT during non-ANI operation**  
(Default is OFF : no limit)

This item is used to set the time-out timer during non-ANI operation.

## ■ General

Cloning allows you to quickly and easily transfer the programmed contents of one transceiver to another transceiver. The IC-V68/U68 transfers clone data at a rate of 1200 bps and cloning is completed in about 10 sec.

### ◇ Connections

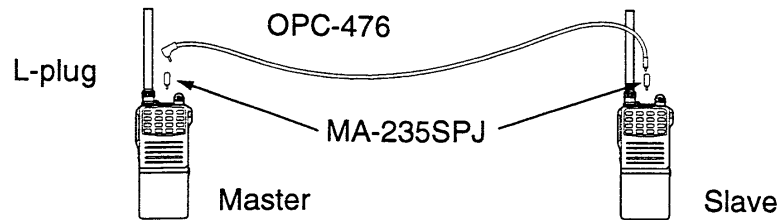

## ■ Cloning between transceivers

- ① Connect the OPC-476 cloning cable with adapter plugs to the [MIC] jack of the master and slave transceivers.
  - The master transceiver is used to send data to the slave transceiver.
- ② While pushing [FUNC] + [B], rotate [VOL] to turn power ON (both transceivers).
  - The transceivers enter the clone standby condition.

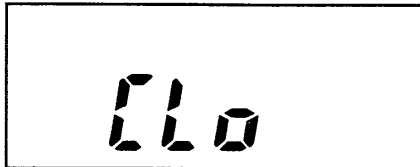

- ③ Push [2] on the slave transceiver.
  - "CL0-1" appears and the slave transceiver is now ready to receive data from the master transceiver.
- ④ Push [1] on the master transceiver.
  - "CL0-0" appears and cloning begins.
  - When cloning is completed, beeps sound and both transceivers return to the clone standby condition.
- ⑤ Push [0] on both transceivers to exit the clone standby condition and return to normal operation.



## ■ Cloning error

**NOTE:** DO NOT push the [PTT] on the slave transceiver during cloning. Cloning will not be successful.

When an error beep sounds during cloning and the display at right appears, a cloning error has occurred.

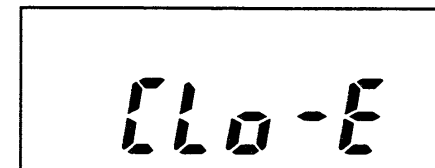

In this case, both transceivers automatically return to the clone standby condition and cloning must be repeated.

# 13 OPTIONS INSTALLATION

There are 2 internal options available for the IC-V68 and IC-U68:

- ➔ The UT-86 TONE SQUELCH UNIT provides subaudible tone encoder and tone squelch functions (the transceiver has a built-in subaudible tone encoder which provides an 88.5 Hz tone only).
- ➔ The UT-88 VOICE SCRAMBLER UNIT provides a voice scrambler function for private communications as well as subaudible tone encoder and tone squelch functions.

To install either unit:

- ① Turn the transceiver power OFF, then remove the battery pack.
- ② Remove the 4 screws from the rear and side panels.
- ③ Pull off the [DIAL] knob, then remove the exposed VR nut.
- ④ Carefully open the front panel from the bottom side.
- ⑤ Unplug pins from J6 and J7.
- ⑥ Plug in either the UT-86 or UT-88 to a connector as illustrated at right.
- ⑦ Reassemble the transceiver.

/// **NOTE:** When installing the UT-88, the voice scrambler function must be turned ON in common set mode; item F4 (p. 35).

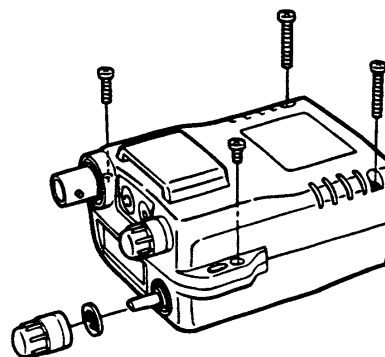

Remove the 4 screws, [DIAL] knob and VR nut.

Open the front panel.

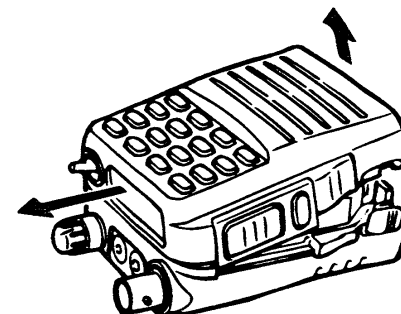

Install the UT-86 or UT-88.

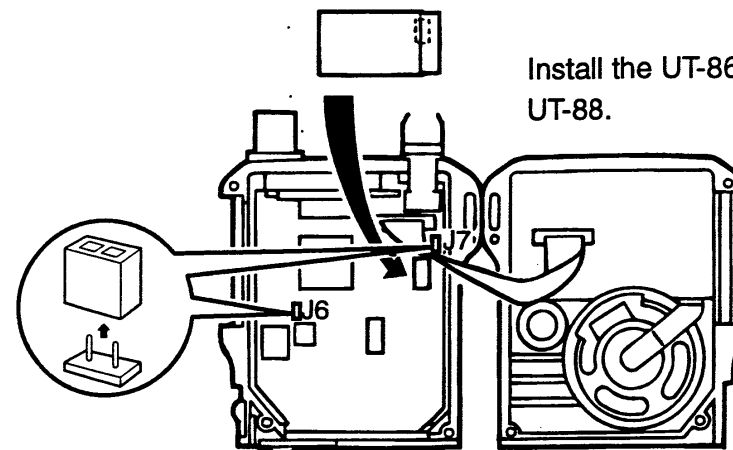

## ■ Specifications

### GENERAL

- Frequency coverage : IC-V68 136–174 MHz  
IC-U68 400–470 MHz
- Number of channels : 40 max.
- Mode : FM (16K0F3E)
- Antenna impedance : 50 Ω (nominal)
- External DC power : 6 to 16 V DC (negative ground)  
12 to 16 V DC (for charging)
- Current drain (at 13.8 V, typ.) :

CONDITION		IC-V68	IC-U68
RX	Power saved	8 mA	15 mA
	Max. audio	150 mA	150 mA
TX	High	1000 mA	1500 mA
	Low	500 mA	700 mA

- Usable temperature range : –10°C to +60°C
- Dimensions : 54(W) × 145(H) × 35(D) mm
- Weight : 330 g

### TRANSMITTER

- Output power : IC-V68 High 5 W (136–150 MHz)  
3 W (150–174 MHz)  
Low 0.5 W  
IC-U68 High 5 W  
Low 0.5 W
- Max. frequency deviation : ± 5 kHz
- Spurious emissions : IC-V68 Less than –60 dB  
IC-U68 Less than –50 dB

### RECEIVER

- Sensitivity : IC-V68 0.25μV for 12 dB SINAD  
IC-U68 0.3 μV for 12 dB SINAD
- Audio output power : More than 350 mW
- Audio output impedance : 8 Ω

## ■ Options

### AD-54 BATTERY CHARGER

Trickle charges battery packs. The BM-95U/E/V AC ADAPTER is necessary in addition. Charging time: 10 to 18 hrs.

### BC-119 DESKTOP CHARGER + AD-66 BATTERY PACK ADAPTER

For rapid charging. An AC adapter is supplied with the charger. Charging time: 1 to 1.5 hrs.

### BC-121 DESKTOP CHARGER + AD-66 BATTERY PACK ADAPTER

For charging up to 6 batteries simultaneously. An AC adapter is supplied depending on version. Six AD-66's are necessary. Charging time: 1 to 1.5 hrs.

### BP-157A, BP-160, BP-174 BATTERY PACKS

BP-157A: 7.2 V; 900 mAh

BP-160: 7.2 V; 700 mAh

BP-174: 12 V; 600 mAh

### BP-99 BATTERY CASE

Takes six (6) AA (R6) size batteries. Equipped with a DC power jack that can be used for both charging and operation. Same as supplied with the transceiver.

### CP-13 CIGARETTE LIGHTER FILTER WITH NOISE FILTER

For operation in a vehicle.

### HM-46, HM-54 SPEAKER-MICROPHONES

### HM-55 DTMF SPEAKER-MICROPHONE

### HS-51 HEADSET

### OPC-288L DC POWER CABLE

### SP-13 EARPHONE

### UT-86 TONE SQUELCH UNIT

### UT-88 VOICE SCRAMBLER/TONE SQUELCH UNIT

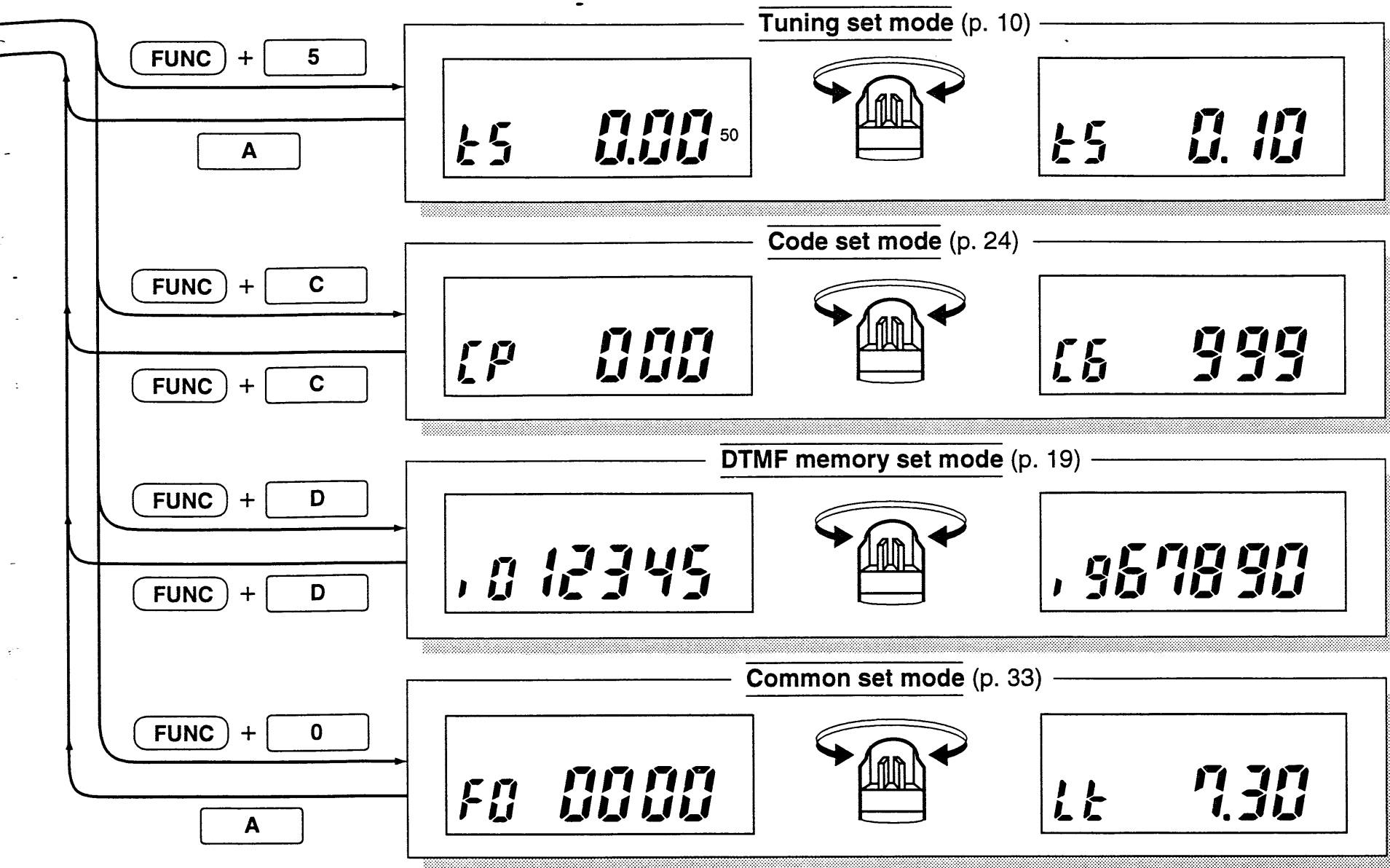

**Count on us!**

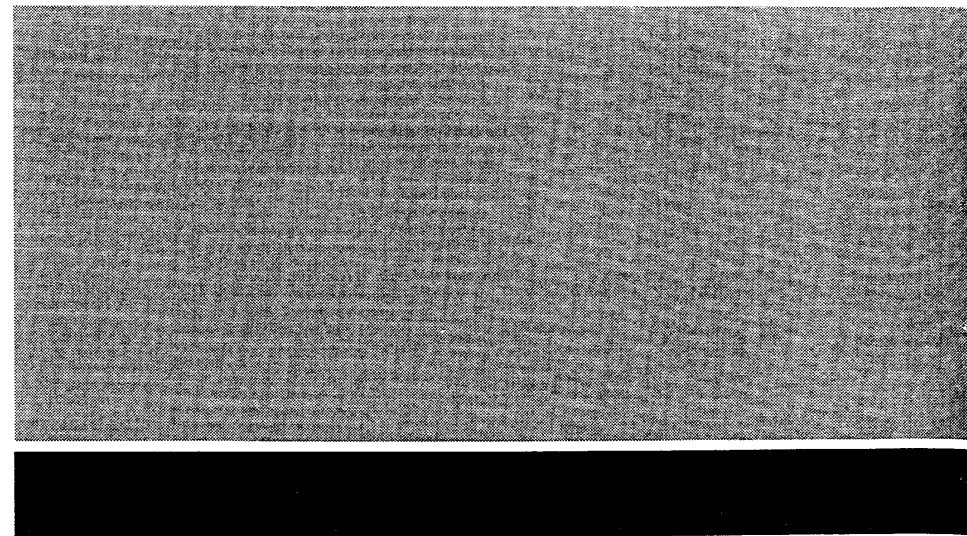

A-5411H-1EX  
Printed in Japan  
Copyright © 1996 by Icom Inc.

**Icom Inc.**  
6-9-16, Kamihigashi, Hirano-ku, Osaka 547, Japan