

# ***YAESU***

***The radio***

## **DR-1X/XE**

### **Installation Instructions for the DR-1X/XE RX-UNIT (V1.00t) and DSP firmware (V4.11)**

#### **Attention !**

Three versions of the update firmware are available. Before installing the new firmware, please check the firmware version of the DR-1X/XE referring to Page 2, and be sure to install the appropriate firmware version.

**V1.00n**

Replaces any firmware versions, other than V1.10D and V1.00f.

Provides **Wide-FM operation**

**V1.10J**

Replaces **V1.10D**.

Provides **Selectable Wide/\*Narrow-FM operation** and  
Supports **Connectivity direct to the HRI-200**

**V1.00t**

Replaces **V1.00f**.

Provides **Selectable Wide/\*Narrow-FM operation**

(\* The narrow band deviation is for some European countries.)

**YAESU MUSEN CO., LTD.**

## Introduction

This firmware update contains the following additional features. If you are not interested in these features, you may skip this firmware update.

- Adjustable Squelch Hysteresis
- Adjustable Squelch Tail
- CWID/Voice Announcements with stripped PL Tones

## How to check the firmware version of the DR-1X Repeater

1. Turn the DR-1X/XE power ON.
2. Touch [SETUP] on the DR-1X/XE LCD screen.  
The firmware version will be displayed at the top of the screen.
3. After confirming the firmware version, turn the DR-1X/XE power OFF.

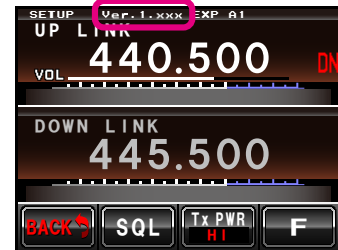

### **CAUTION!**

*Be sure to confirm the model and the version of your repeater before starting the installation. Writing incorrect firmware to the repeater may cause abnormal operation or failure.*

## Necessary material and System Requirements (Operating Environment) for Firmware installation

**Notes:** In order to use this program, a personal computer (PC) with one of the following Windows operating systems and a SCU-20 PC connection cable are required.

### **Supported Operating Systems**

The firmware installation programmer requires one of the following operating system environments:

- Microsoft® Windows® 10 (32 bit / 64 bit)
- Microsoft® Windows® 8.1 (32 bit / 64 bit)
- Microsoft® Windows® 8 (32 bit / 64 bit)
- Microsoft® Windows® 7 (Service Pack 1 or later)
- Microsoft® Windows Vista™ (Service Pack 2 or later)

### **CPU**

The CPU performance must satisfy the operating system requirements.

### **RAM (System Memory)**

The RAM (system memory) must be more than sufficient to satisfy the operating system requirements.

### **HDD (Hard Disk Drive)**

The HDD capacity must exceed the operating system requirements.

In addition to the required operating system memory space, about 50 MB of additional memory space is required to run the firmware installation program.

### **Necessary PC peripheral interfaces**

An available USB interface (USB Port)

### **Cable**

SCU-20 PC connection cable

## Important Notes

---

- All responsibility for the use of this software lies with the customer. YAESU MUSEN CO., LTD cannot be held liable in any way for damages or losses, which may be incurred by the customer as a result of using this software.
- Copyrights and all other intellectual property rights for the software, as well as the software manual, are the property of YAESU MUSEN CO., LTD.
- Revision, modification, reverse engineering, or decompiling of this software is prohibited. Redistribution, transfer, or resale of downloaded files, is also prohibited.
- Downloaded files are for personal use only, any commercial use is prohibited.
- If you cannot perform the firmware installation yourself, please consult with one of our sales sites or service centers for assistance.

Company and product names described in this manual are trademarks or registered trademarks.

Microsoft®, Windows®, Windows Vista®, Windows® 7, Windows® 8, Windows® 8.1, Windows® 10 are registered trademarks of Microsoft Corporation in the United States and other countries.

## Install / Uninstall Procedure

---

### Installation procedure

Please visit Yaesu website (<http://www.yaesu.com/>) and download the Firmware files (see below).

- **RX-UNIT:** DR-1X\_MAIN\_vR100t
- **DSP:** PCTOOLe\_v0411

### Uninstall procedure

Delete the folder opened by the program.

The operation will end if the opened folder is deleted since no data will be written to the registry and system folder.

## Using the Programmer

Before attempting to update the firmware, use the SCU-20 PC Connection Cable and install the driver software.

Then go to the website (<http://www.yaesu.com/>) to download and install the SCU-20 driver.

When the programmer is opened on the computer, press the [Update] button to display the preparation procedure screen, which explains the firmware installation process. Follow the procedure below.

### Installation of the RX-UNIT firmware

1. Remove the 15 screws from the top cover and then remove the cover.

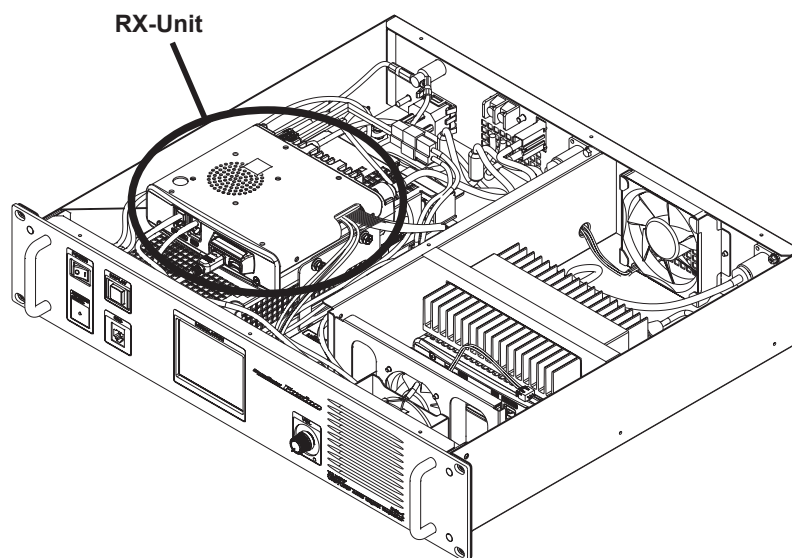
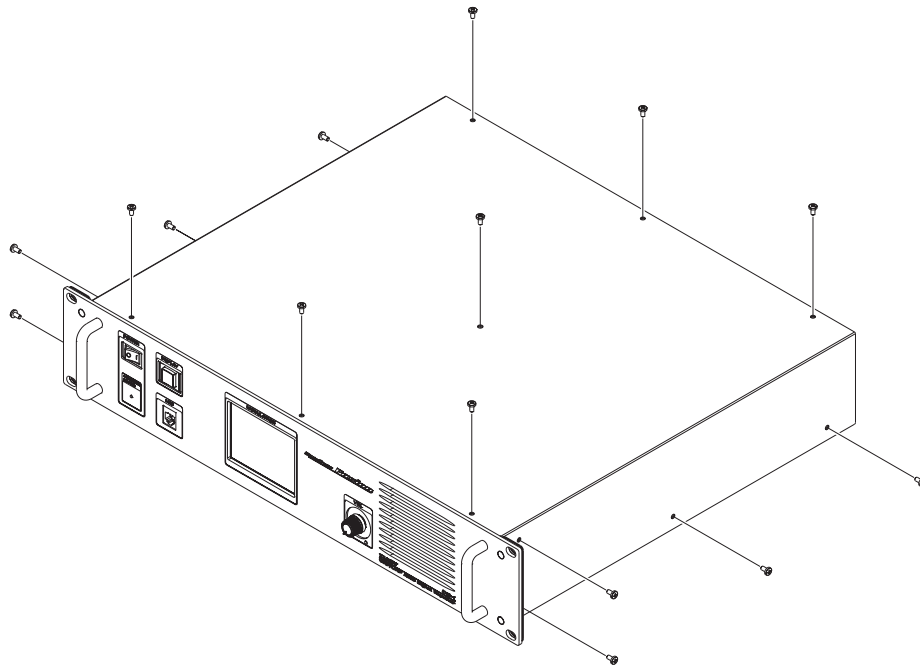

- Through the hole at the front left of the RX-UNIT case, change the RX-UNIT firmware-writing switch inside to the BOOT position (rearward).

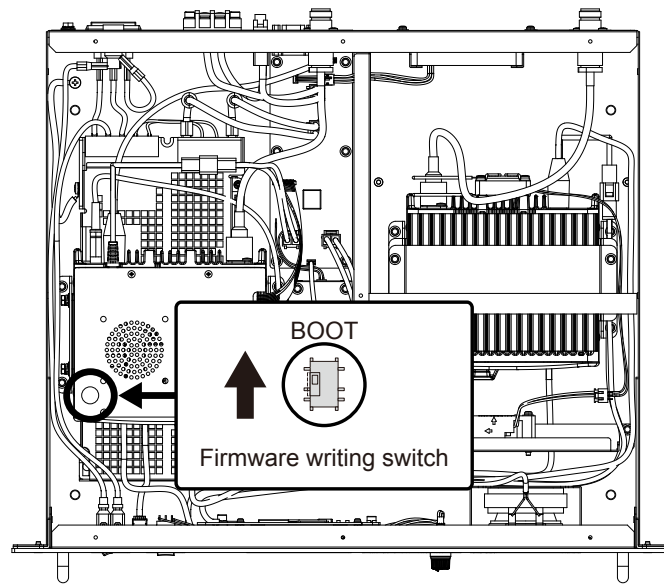

- Connect the SCU-20 PC connection cable to the ACC jack, and connect the AC or DC power cord to DR-1X (DC power cord to DR-1XE).

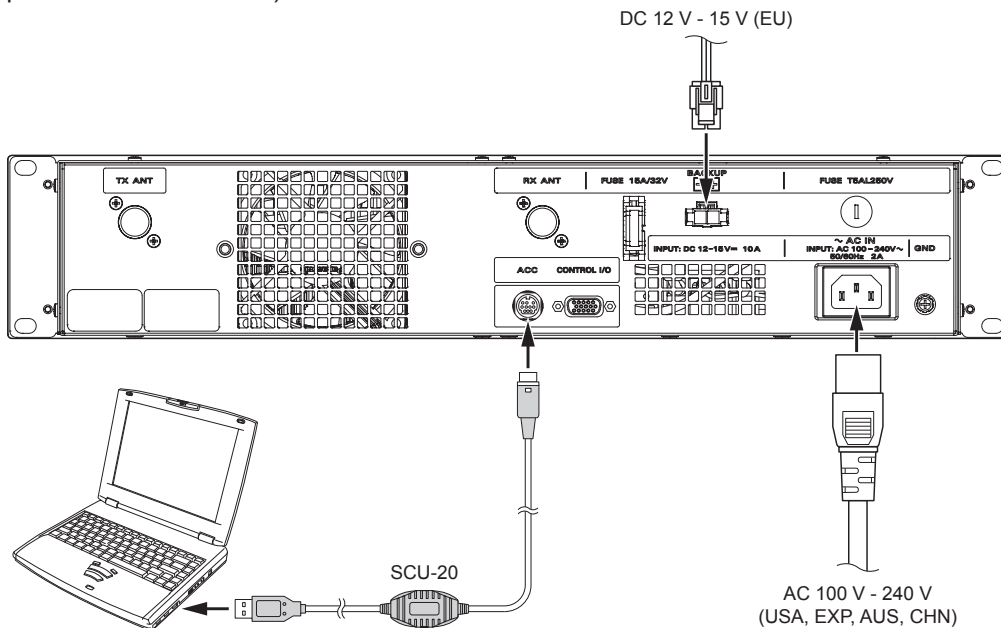

### **Install the firmware**

- Turn the DR-1X/XE power ON.  
The cooling fan will start rotating but nothing will appear on the LCD screen.
- Open the "DR-1X\_MAIN\_vR100t" folder on the personal computer, and then Double-click the "DR-1X\_MAIN\_vR100t(exp).exe" file that is saved on your PC to execute the program.
- Follow the on-screen instructions on your PC to install the DR-1X/XE firmware.
- Select the COM Port number assigned when you installed the SCU-20, and press "Update".
- After the installation completes, turn the DR-1X/XE power OFF, and then through the hole at the forward left of the RX-UNIT case, set the RX-UNIT firmware writing switch inside to the original position (forward).
- Turn ON the DR-1X/XE, power and then touch [SETUP] to view the firmware version number displayed at the top of the screen. If the install was successful, the firmware version number (Ver. 1.00t) will be displayed.

## Installation of the DSP firmware

**Note:** Install the MAIN firmware before attempting to Install the DSP firmware.

1. Connect the SCU-20 PC connection cable to the ACC jack on the DR-1X rear panel.

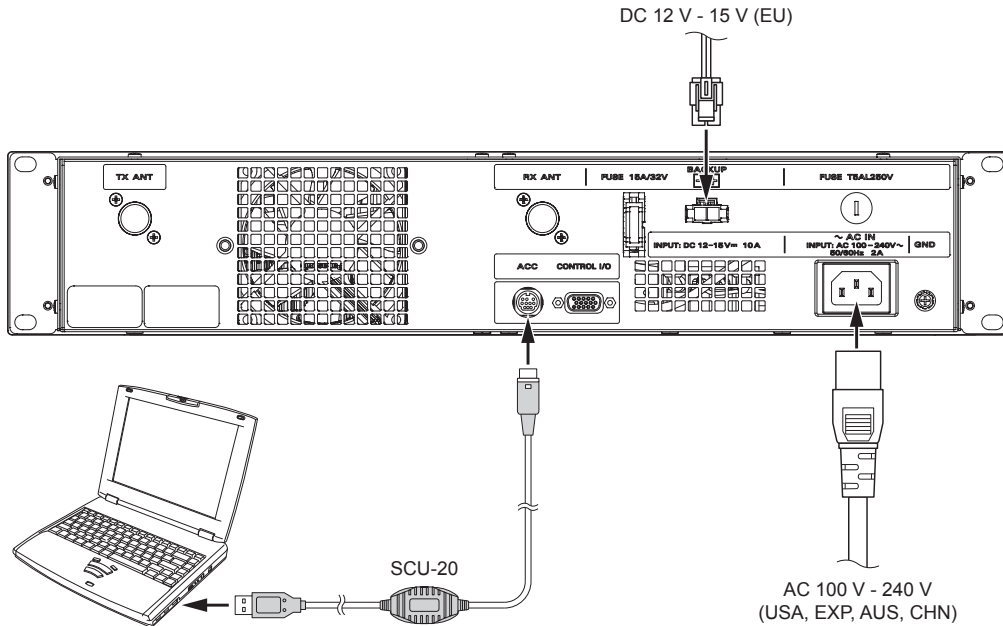

2. Touch and hold the DR-1X/XE LCD screen while turning the DR-1X/XE ON.
3. Press the [SETUP] switch button, (although "PUSH DISP" message is displayed on the screen).  
"DSP <--> COM" will appear on the display

## Install the firmware

1. Open the "PCTOOLe\_v0411" folder on the personal computer, and then Double-click the "PCTOOLe\_v0411.exe" file that is saved on your PC to execute the firmware installation program.
2. Select the COM Port number that was assigned when you installed the SCU-20 programming cable, and then press "OK".
3. When the pop-up screen is displayed, press the "OK" button
4. After the firmware installation completes, press "OK".
5. Turn the DR-1X/XE power OFF.
6. Disconnect the SCU-20 programming cable.
7. Replace the top cover, and fasten it using the 15 screws.

This completes the firmware installation process.

## The following functions have been added to the DR-1X/XE repeater.

### SQL HYSTERESIS

Hysteresis is the difference between the signal level that will open the receiver squelch, and the signal level at which the squelch again closes. Increasing the hysteresis will suppress repeated opening and closing of the squelch.

1. Touch **[SETUP]** in the operation mode screen

The setup mode screen will appear.

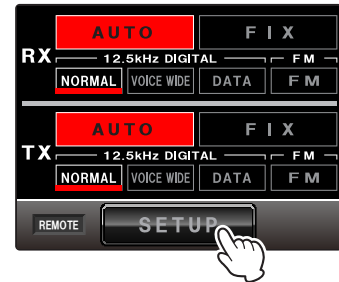

2. Touch **[F]** in the setup mode screen

The setup menu will appear.

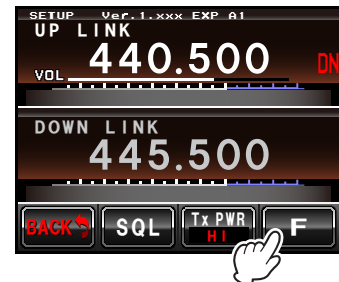

3. Touch **[TOT]**

The menu list will appear.

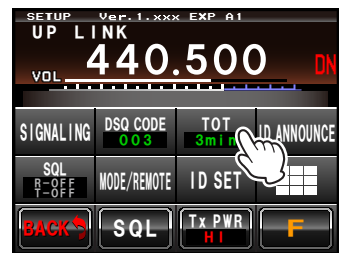

4. Select and touch **[SQL SETTING]**

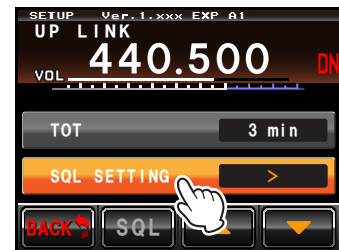

5. Select and touch **[SQL HYSTERESIS]**

6. Touch **[▲]** or **[▼]**

The set value will change in the following sequence each time it is touched.

“NORMAL” ➡ “HIGH” ➡ “MAX”

**NORMAL:** The squelch open signal level and the squelch close signal level are the same.

**HIGH:** The squelch open signal level is higher than the squelch close signal level. (Makes squelch less likely to close.)

**MAX:** The squelch open signal level is much higher than the squelch close level. (Makes squelch even less likely to close.)

**Tip** Factory default: NORMAL

7. Touch **[BACK]**

The setting is determined and the display will return to the setup menu.

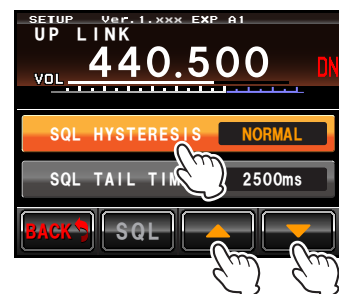

## SQL TAIL TIME

Enables setting the time duration of the downlink transmit after the uplink signal ceases.

1. Touch **[SETUP]** in the operation mode screen  
The setup mode screen will appear.

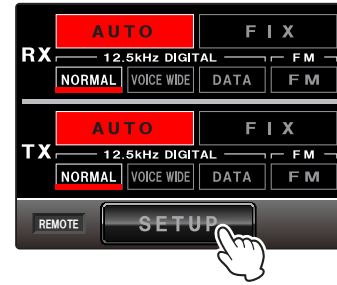

2. Touch **[F]** in the setup mode screen  
The setup menu will appear.

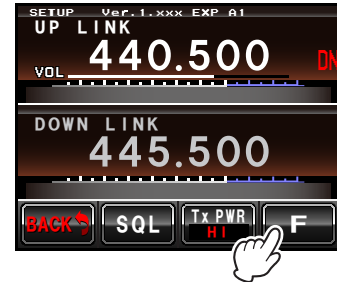

3. Touch **[TOT]**  
The menu list will appear.

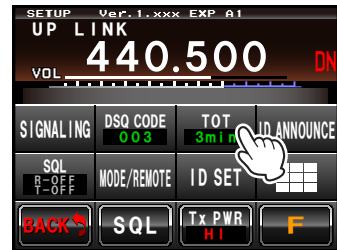

4. Select and touch **[SQL SETTING]**

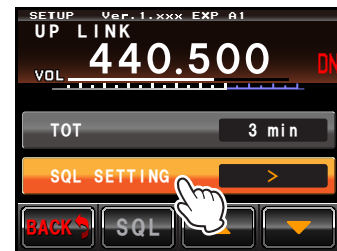

5. Select and touch **[SQL TAIL TIME]**

6. Touch **[▲]** or **[▼]**

The set value will change in the following sequence each time it is touched.

0ms ➡ 50ms ➡ 100ms ➡ 150ms ➡ 200ms ➡ 250ms ➡ 300ms ➡  
 350ms ➡ 400ms ➡ 450ms ➡ 500ms ➡ 600ms ➡ 700ms ➡  
 800ms ➡ 900ms ➡ 1s ➡ 1.1s ➡ 1.2s ➡ 1.3s ➡ 1.4s ➡ 1.5s ➡  
 1.6s ➡ 1.7s ➡ 1.8s ➡ 1.9s ➡ 2.0s ➡ 2.1s ➡ 2.2s ➡ 2.3s ➡  
 2.4s ➡ 2.5s

**Tip** Factory default: 0ms

**Note** This setting is effective only when the uplink call termination signal cannot be received normally.

7. Touch **[BACK]**

The setting is determined and the display will return to the setup menu.

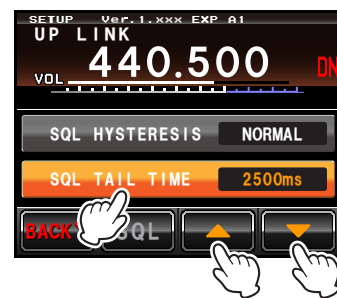



### **New set item added to [ID ANNOUNCE]**

In the Setup menu, touch **[ID ANNOUNCE]** and then touch **[ANNOUNCE]**.

“CW wo TONE” and “VC wo TONE” have been newly added to the ANNOUNCE mode.

When “CW wo TONE” is selected, The CTCSS TONE or DCS code (or other code) will not be added to the signal while the INTERVAL CW ID is transmitted.

When “VC wo TONE” is selected, The CTCSS TONE or DCS code (or other code) will not be added to the signal while the voice ID announcement is being transmitted.

**Note** Please note the following regarding operation of the repeater ID when the ANNOUNCE mode is set to “CW wo TONE” or “VC wo TONE”.

1. During initial activity after the DR-1X/XE is first powered on; the ID is sent with tone when the ANNOUNCE mode is set to “CW wo TONE” or “VC wo TONE”.
2. During repeater inactivity the ID will be sent without tone when “CW wo TONE” or “VC wo TONE” is selected.
3. If the DR-1X/XE is sending the ID and a user transmits, the incoming audio is muted until the ID is finished being sent when “CW wo TONE” or “VC wo TONE” is selected.
4. When the DR-1X/XE is active and the ID timer expires, the ID is sent with tone when “CW wo TONE” is selected. The ID and ongoing audio are mixed.
5. When the DR-1X/XE is active and the ID timer expires, the ID is sent with tone when “VC wo TONE” is selected. The Voice ID and ongoing audio are not mixed, the ongoing audio is muted while the Voice ID is sent.



Copyright 2016  
YAESU MUSEN CO., LTD.  
All rights reserved.

No portion of this manual  
may be reproduced  
without the permission of  
YAESU MUSEN CO., LTD.