

1 AUG. 67

INTRODUCTION

The PIN diode has opened the way to a new method of modulating microwave signals. Placed across a transmission line, the PIN diode becomes an absorption-type attenuator which permits sine-wave, square-wave, and pulse modulation without frequency pulling.

The limitations of present amplitude modulation methods are becoming more evident with the advance of microwave technology. For example, it has been nearly impossible to amplitude modulate a klystron oscillator directly with anything but a square wave or pulse. Sine-wave modulation traditionally results in significant frequency shifts with changes in amplitude. In addition, conventional klystron oscillators have relatively slow rise and decay times and poor frequency stability, and jitter in the rf pulse is too high for precise pulse measurements. Modulators for lower-frequency triode master-oscillator-power-amplifier (MOPA) generators have low on-off ratios, and speed of rise and decay of the modulated signal is limited by the Q of the modulated stage.

PRINCIPLES OF OPERATION

The PIN Modulator is a high-speed, current-controlled absorption type attenuator. A simplified illustration of the hp Model 8730A/B series PIN Modulators is shown in Figure 1. Each PIN unit includes a low-pass filter, two high-pass filters, a number of PIN diodes, and a 50-ohm strip transmission line (ridged waveguide in the higher frequency units).

The PIN diode is a silicon junction diode whose P and N trace regions are separated by a layer of intrinsic (I) semiconductor (silicon). Thus the name PIN diode.

At frequencies below about 100 Mc the PIN diode rectifies as a junction diode. However, at frequencies above 100 Mc, rectification ceases due to stored charge in the intrinsic (I) layer and the diode acts like a resistance by conducting current in both directions. This equivalent resistance is inversely proportional to the amount of charge in the I layer. An increase in forward bias current (current at a negative voltage) increases the stored charge and decreases the equivalent resistance of the PIN diodes. When reverse bias is applied, reverse current flows until stored charge is depleted at which time equivalent resistance becomes a maximum, in the order of thousands of ohms.

To understand how a PIN Modulator works, consider the following: the PIN diodes are mounted as shunt elements between the RF transmission path and ground. The transmission path has a characteristic impedance of 50 ohms. When the PIN diodes are forward-biased the equivalent diode resistance is about 30 ohms and most of the RF energy is absorbed by the diodes instead of propagating down the 50-ohm transmission path. However, when the diodes are reverse- or back-biased the equivalent diode resistance is in the order of thousands of ohms and the microwave currents will flow down the transmission path because diode resistance compared to the 50-ohm path impedance is negligible.

GENERAL OPERATION

The PIN Modulators are three-port devices which accept RF power at either end-port and, depending upon the BIAS signal applied, provide a modulated RF output at the other end-port. As an operating device, the PIN Modulator should be thought of as a variable RF attenuator whose attenuation level is controlled by DC current and voltage. By applying a +5 volt DC potential to the BIAS input connector, RF signals will be passed through the PIN Modulator with only minimum residual attenuation. By applying a current equal to the value stamped on the instrument label (at about 0.7 volts DC) at the BIAS input, at least rated attenuation is provided at all points across the frequency band (i.e., for "A" models at least 35 db and for "B" models at least 80 db). The DC current at a negative voltage is forward-bias and typically is about 3 to 5 ma for "A" models and 6 to 7 ma for "B" models. By varying the forward bias current between the stamped value and zero, any level below maximum rated attenuation can be established. Figure 2 shows typical residual attenuation curves.

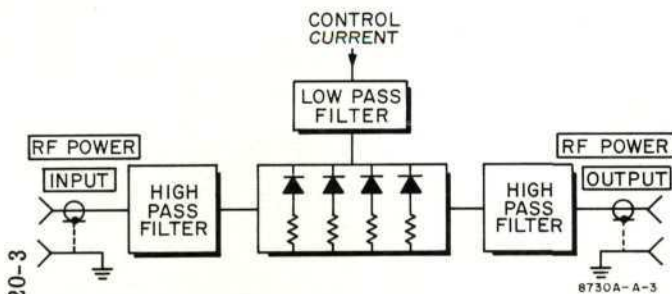

Figure 1. Simplified Block Diagram of PIN Modulator

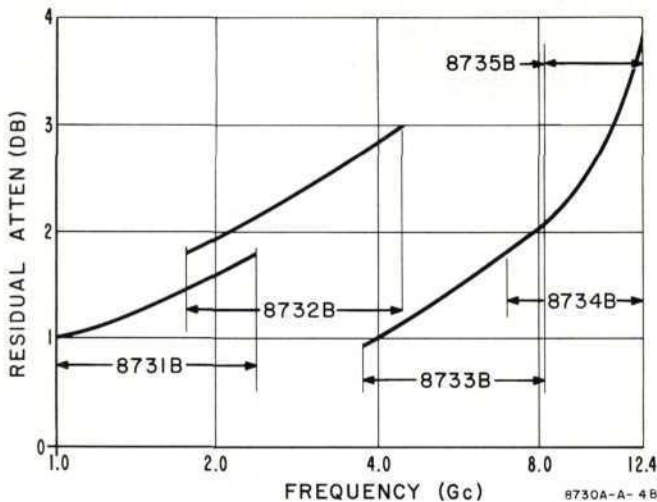

Figure 2. Typical Residual Attenuation

The attenuation increases with forward bias current almost linearly with db until the diodes saturate. The attenuation sensitivity varies from unit to unit and also with time for individual units. For this reason the PIN Modulators are not suitable for use as programmed attenuators. The range of expected sensitivity variation between units, and for a single unit with time, is shown in the shaded areas of the typical 35-db and 80-db attenuation plots in Figure 3.

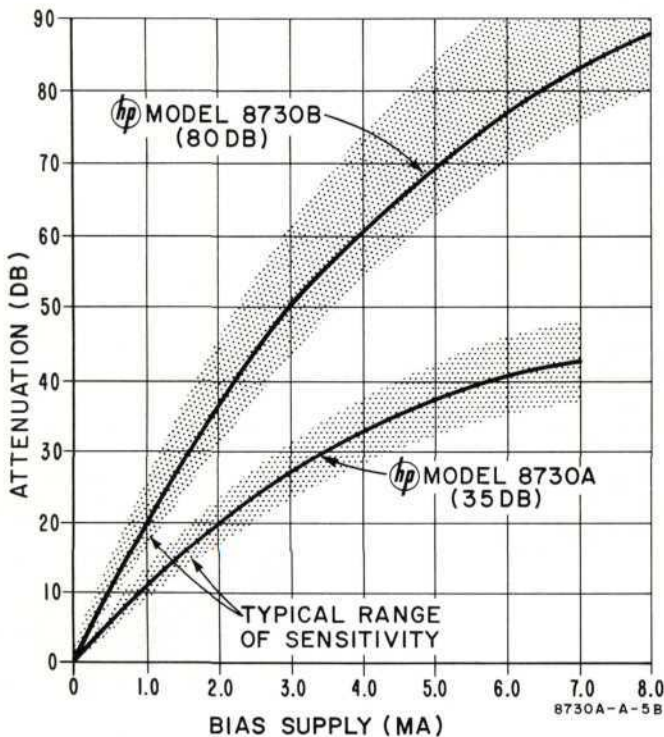

Figure 3. Typical Sensitivity (Plotted with frequency constant)

The attenuation with a constant forward-bias varies with frequency. This variation is small at low levels of attenuation and more noticeable at higher values of attenuation (see Figure 4). In addition, it should be noted that attenuation is a minimum at each end of the frequency band. Thus, the frequency band can be exceeded provided a degradation in attenuation range as well as other specifications is acceptable. Note: exceeding the band limits by a large degree is unpractical.

IMPEDANCE MATCH

The PIN Modulator has a good impedance match at all levels of attenuation over its frequency range. This match is illustrated in Figure 5, which shows the SWR of a typical PIN Modulator measured under both zero bias and maximum forward bias conditions. Hence, with this constant match, frequency pulling effects due to the PIN Modulator is negligible. If the PIN Modulator is used outside its specified frequency range, SWR characteristics will be degraded in addition to other operating specifications. Also, spurious responses can result when exceeding specified frequency range.

TEMPERATURE STABILITY

The attenuation variation with applied bias current and bias voltage at different temperatures is illustrated, over a limited range, in Figure 6. Attenuation in DB varies almost linearly with current, while variation with voltage follows an almost perfect exponential curve. If a constant voltage is maintained, the attenuation rises with increasing temperature. With a constant current, the attenuation drops with increasing temperature. The fact that the attenuation varies oppositely with temperature for constant-voltage and constant-current operation suggests that an optimum voltage with a selected series resistor added between the source and the PIN Modulator would give temperature compensation over a limited operating range. This compensation is not built into the PIN Modulator.

CLOSED LOOP LEVELING

The PIN Modulator can be used in a closed loop leveling system as the power limiting device for maintaining RF power levels constant. A simplifier block diagram of a closed loop leveling system employing a PIN modulator is shown in Figure 7. The system consists of some sampling device which samples the main line RF power level; a detecting device which provides a DC signal proportional to the sampled signal; some comparison device which compares the detected signal to what it should be when main line power is at its lowest point and then provides a bias current sufficient to increase PIN Modulator attenuation and maintain a constant RF power level.

LEVELING CAPABILITY. In a closed-loop leveling system involving a PIN Modulator, leveling capability depends entirely upon loop equipment. Hence, loop equipment should be selected on the basis of main line RF power levels and leveling requirements. In the closed-loop system shown in Figure 8 the flatness of leveling is determined primarily by the coupling variation of the directional coupler used. The Power Meter is used because it provides extra loop gain. In addition,

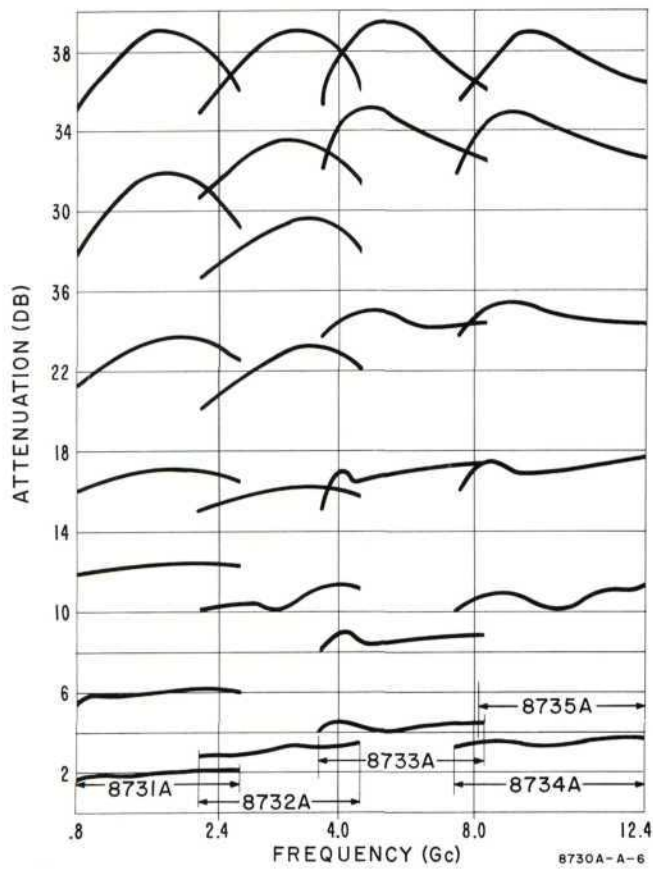

Figure 4. Typical Frequency Response

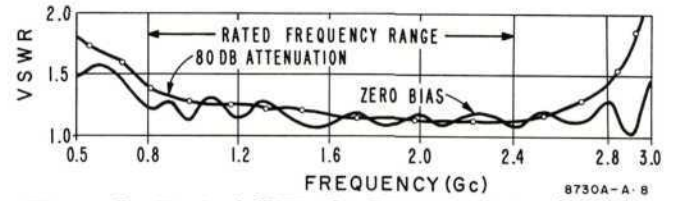
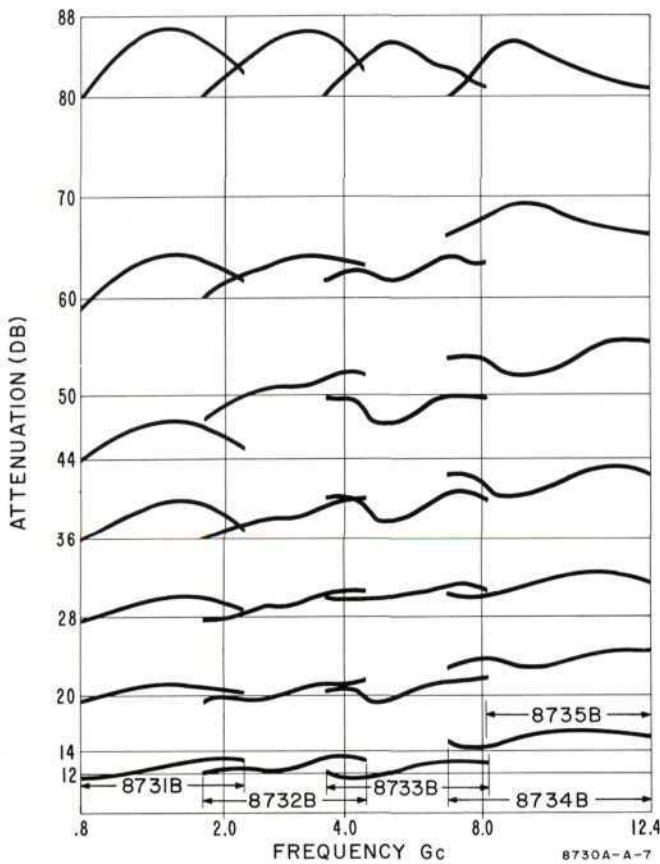

Figure 5. Typical SWR of a PIN Modulator (8732B)

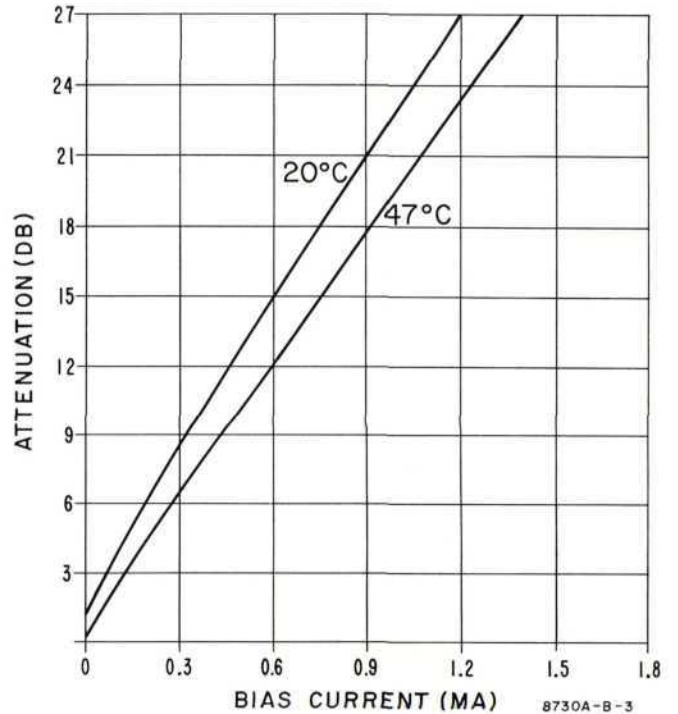
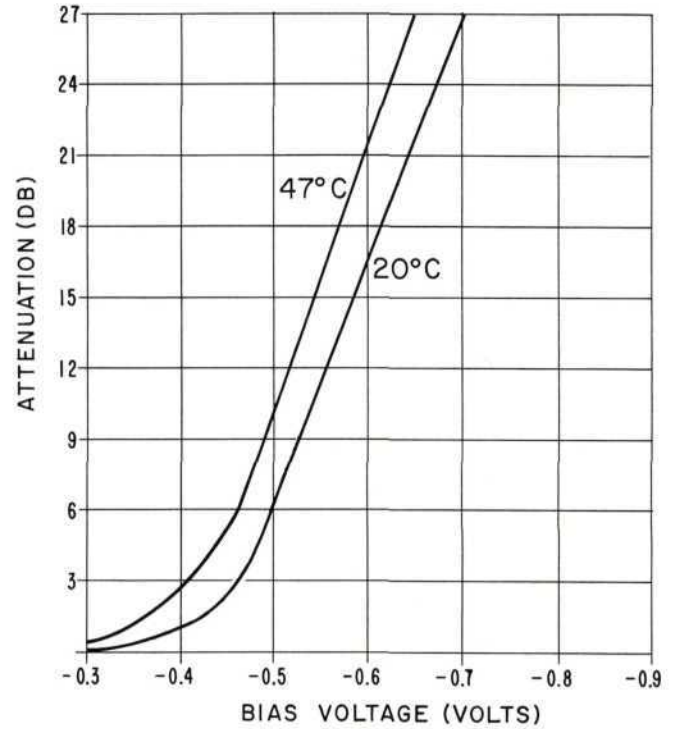

Figure 6. Typical Attenuation Variation at two Different Ambient Temperatures

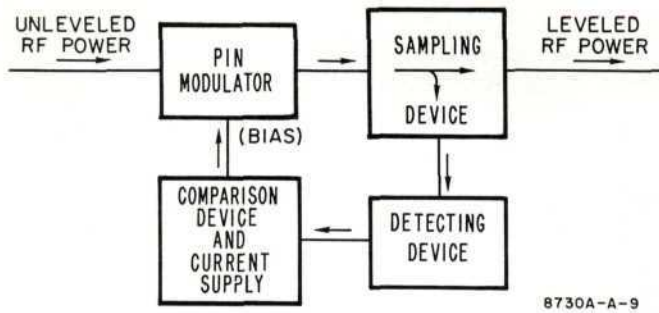

Figure 7. Simplified Block Diagram of a Closed Loop Leveling System

with output coupling known, the main line output power can be read directly on the Power Meter allowing for coupling variation. The Leveler Amplifier used has a 0 to -27 vdc output capability with output impedance of about 20K ohms, hence the 20K ohms series resistor makes it a bias current source providing a maximum 1.35 ma DC current (referring to Figure 5, this means that the maximum control range possible using an "A" model 8730 is between 12 and 20 db depending upon the individual 8730 used). Typically, with the Power Meter and Leveler Amplifier combination, leveled power can be held constant with ± 0.2 db (plus coupler variation) for RF swept frequency rates equal to or longer than 30 seconds/octave. In practice, slower swept frequency rates always produce the best leveling. However, to determine whether or not any system is leveling properly an Oscilloscope should be used. Figure 9 compares unlevelled and leveled output of a klystron.

For faster leveled swept frequency rates, negative output detector and directional coupler combinations such as the hp Model 786D and 787D Directional Detectors can be used instead of the Power Meter and

Thermistor Mount combination described above. Typically, for the Directional Detector and Leveler Amplifier combination, leveled power can be held constant with ± 0.2 db (plus frequency response of Directional Detector). Note: the frequency response of the Directional Detector includes coupling variation and RF response of the crystal. For the Model 786D (0.96 to 2.11 Gc) this is ± 0.2 db.

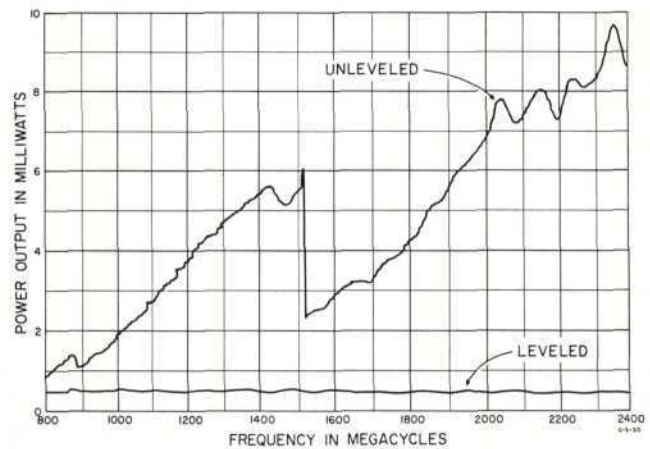

Figure 9. Leveled and Unleveled Klystron Output vs Frequency

AMPLITUDE MODULATION

The PIN Modulator can be used to amplitude-modulate the RF signal with almost any time-varying signal. Modulation is accomplished with a DC bias current to obtain a specific attenuation level and then superimposing a time varying current upon the bias current. The specific attenuation level upon which the modulating signal is superimposed must be equal to or greater than the peak amplitude of the modulating signal or peak clipping will occur. A control instrument designed for use in modulating applications with the PIN Modulators is the hp Model 8403A Modulator which provides frequency compensation for extending the PIN Modulator

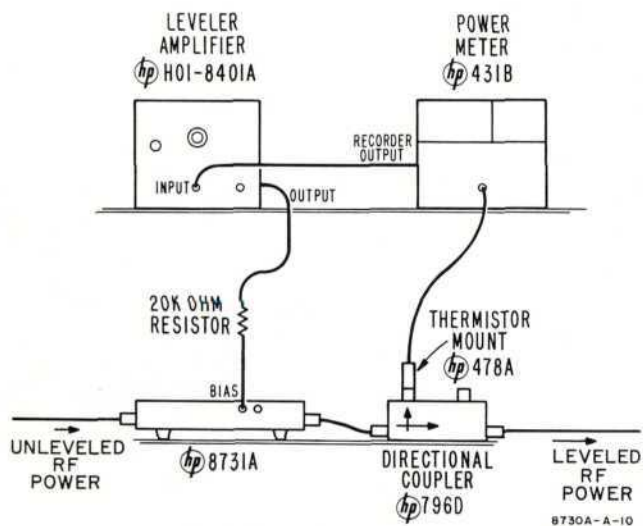
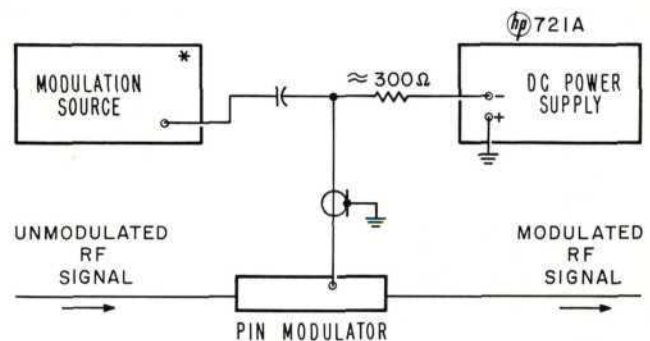

Figure 8. Typical Closed Loop Leveling System



* FOR PULSE MODULATION: hp MODEL 211A, 212A, 214A, 215A
 FOR AMPLITUDE MODULATION: hp MODEL 208A, 651A
 8730A-A-11

Figure 10. Typical General Modulation Setup

AM frequency response to 10 Mc. However, a typical setup for modulating applications, without the use of the hp Model 8403A Modulator, is illustrated in Figure 10.

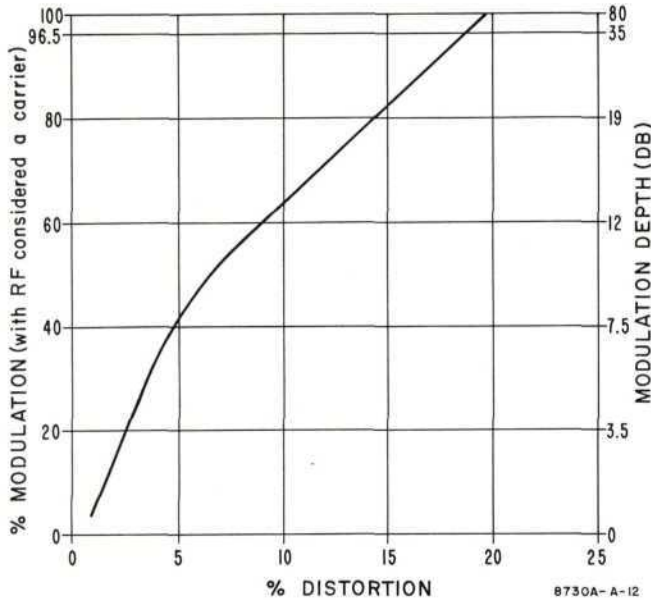

Figure 11. Typical AM Distortion

MODULATION DISTORTION. When a PIN Modulator is used in an AM system, some envelope distortion occurs. This distortion is a function of the peak attenuation and total attenuation range covered by the modulating signal. To minimize RF envelope distortion, the reference level upon which the modulating signal is superimposed should always be a minimum (i.e., reference level should be set at a point only slightly greater than the peak modulating signal amplitude). Under these conditions, a 50% sinusoidal modulating signal (9.5 db total swing) will result in less than 6.1% distortion. A plot of measured AM distortion for a typical PIN Modulator is shown in Figure 11. Note: AM distortion was measured under the optimum conditions described above. Since distortion, as described here, is a function of the non-linear sensitivity relationship (shown in Figure 5), shaping circuits may be incorporated to limit overall distortion.

AMPLITUDE MODULATION LIMITATION. In any AM system the modulating equipment limits RF modulating capabilities almost entirely. For example, the power supply and modulation signal source must both be capable of supplying sufficient current to the low impedance 8730 BIAS input. See Figure 3 for typical currents necessary for desired attenuation levels. In addition, the PIN Modulator itself limits the total percent of modulation obtainable. With 35 db attenuation, AM percent of modulation is limited to a maximum of about 96.5%; with 80-db attenuation the percent of modulation is for all practical purposes 100%.

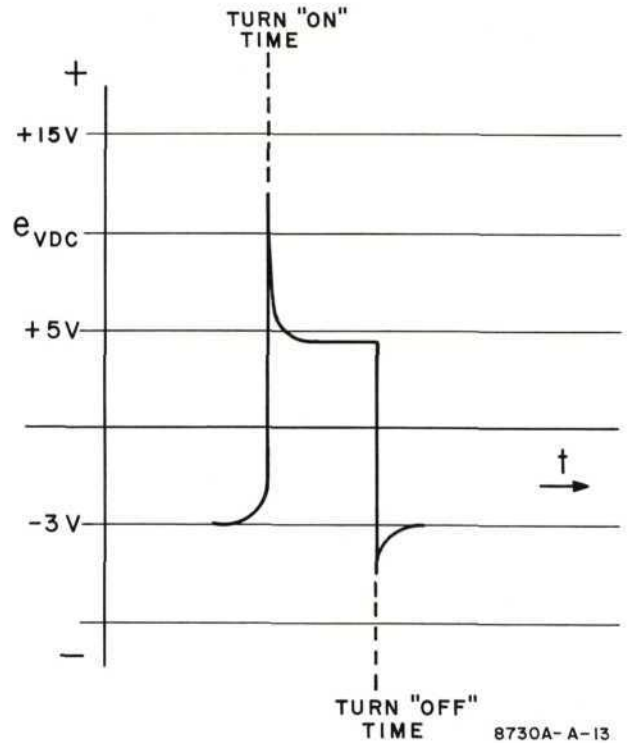

Figure 12. Dynamic Bias Switching Waveform

PULSE MODULATION

The PIN Modulator can be used as a pulsing or switching device for RF power levels. Modulation is accomplished by applying rated forward bias (see label attached to underside of PIN Modulator) for a maximum attenuation. Once maximum attenuation level is established, the RF power may be pulsed "on" by applying a constant +5 to 6 volts to the BIAS input (voltage must be referenced to PIN Modulator ground). At the end of desired pulse width, the +5 to 6 volt DC potential must be switched to a -0.8 volt level with rated bias current so that RF power level is pulsed "off".

To obtain pulsing with rise and fall times in the order of 15 to 40 nanoseconds, the PIN Modulator must be biased with the hp Model 8403A or from a specially shaped impulse waveform such as is illustrated in Figure 12. However, if rise and fall times in the order of 100 to 300 nanoseconds are satisfactory, a setup such as is shown in Figure 10 may be used. Note: in any modulation system, modulation capability depends upon the modulating waveform at the BIAS input connector. Hence, lead lengths should be as short as possible to avoid capacitive cable effects. Figure 13 shows typical pulse waveforms.

SIGNAL SEPARATION (GATING)

Figures 14 and 15, respectively, illustrate use of the PIN Modulator as an RF gating device for eliminating spurious or "ghost" signals in antenna range receivers (Figure 14) or multiple signal separation in a spectrum analysis system (Figure 15).

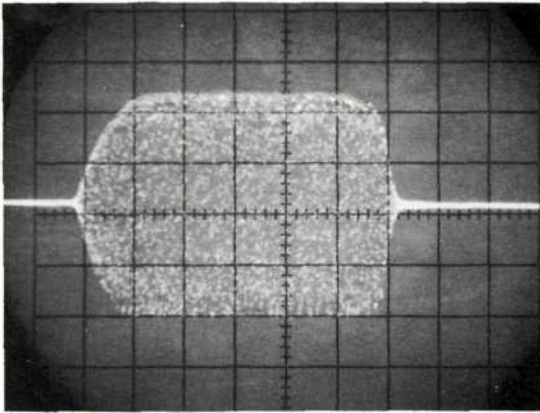

A 100-nsec RF Pulse
(Sweep Time: 20 nsec/div)

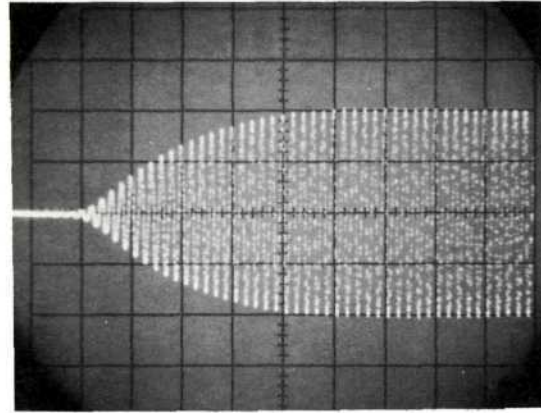

RF Pulse Expanded to Show Rise Time
(Sweep Time: 5 nsec/div)

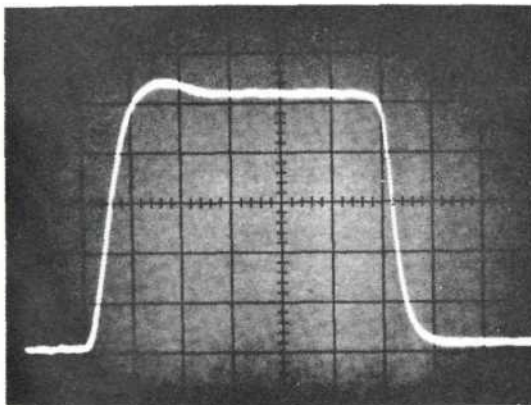

Detected 100-nsec Pulse
(Sweep Time: 20 nsec/div)

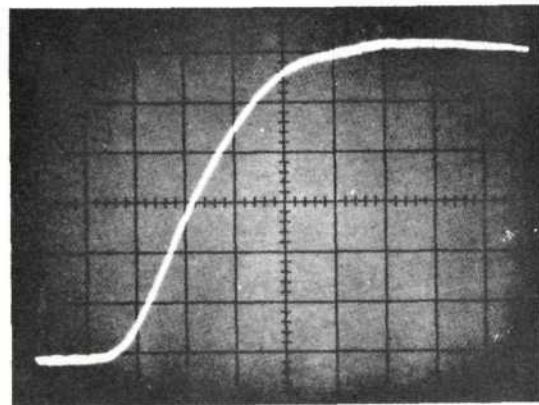

Detected Pulse Expanded to Show Rise Time
(Sweep Time: 5nsec/div)

Figure 13. Typical Pulse Waveforms (viewed on hp Model 185A Oscilloscope)

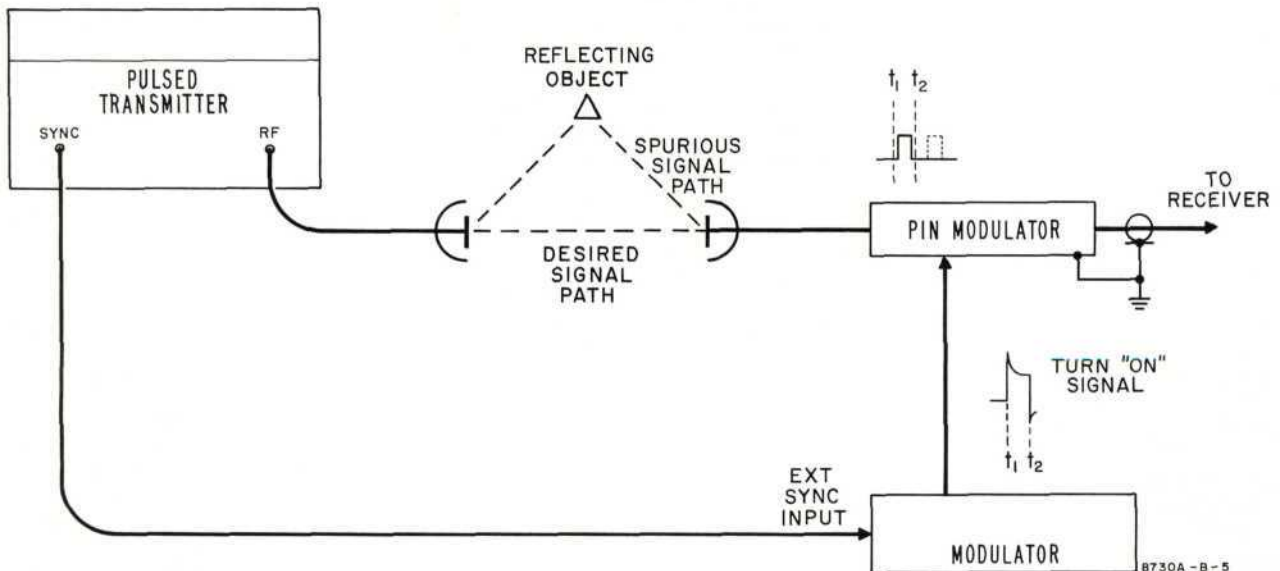
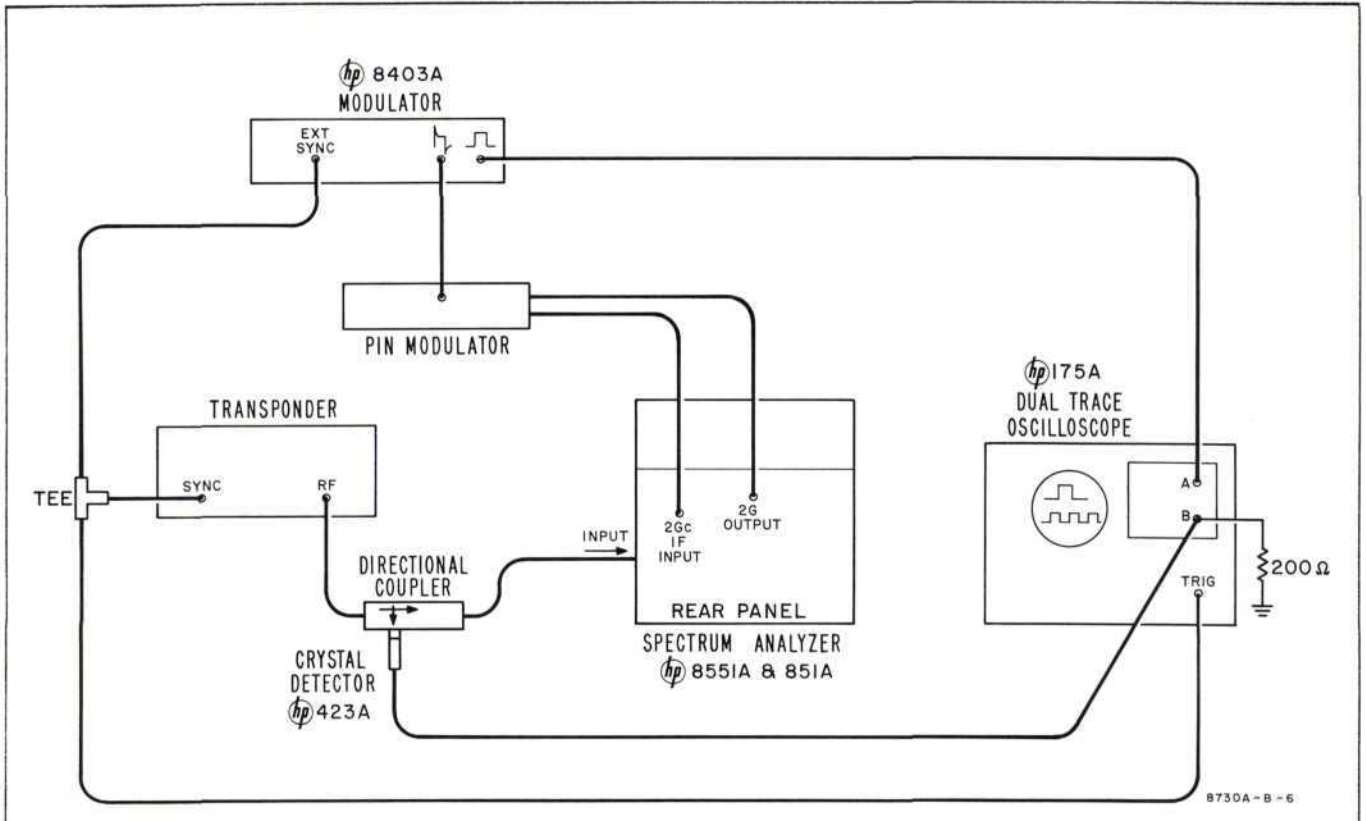

Figure 14. Typical Use of PIN Modulator as an RF Gating Device



In the above setup, the PIN Modulator is used to attenuate all pulse inputs in multiple train except the one of interest. Using the DELAY control on the hp Model 8403A Modulator and noting the Oscilloscope presentation, you can see which pulse is not being blanked. The PIN Modulator is placed in the Spectrum

Analyzer 2Gc-IF path so that the Frequency of the RF input need never affect the PIN Modulator. For this setup either a Model 8731B or a Model 8732B may be used since they both cover the 2 Gc frequency range of the IF path.

Figure 15. Multiple Signal Separation for Spectrum Analysis

MULTIPLE FUNCTION

For certain applications, it may be desirable to level and amplitude modulate a given RF power level with the same PIN Modulator. This can be accomplished by simply setting up a closed loop leveling system and adjusting the reference attenuation level to a point equal to the peak amplitude of the desired modulating signal. For this type of dual application the modulating signal can be applied directly to the leveler amplifier in the system shown in Figure 8.

The high on/off ratio available in the "B" series Modulators make them ideal for use as SPST switches. One application is the tracking of fast moving objects by switching an array of antennas in sequence, as shown in Figure 16. Since tracking is done electrically, the mechanical inertia of a single tracking antenna poses no problem.

Unlimited possibilities exist when two or more modulators are used in a microwave system. For example, suppressed carrier modulation is obtained with a balanced modulator using two 3-db couplers and two Modulators, as shown in Figure 17. A 90° phase shift is introduced by each coupler in one RF path and when

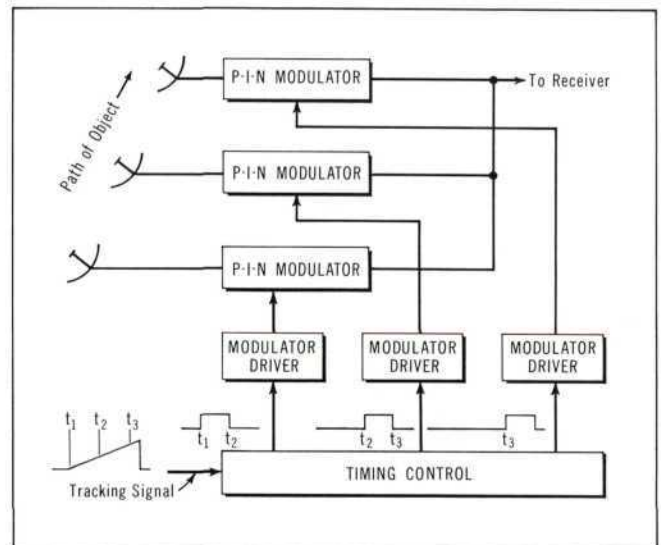

Figure 16. PIN Modulators are useful for switching antennas sequentially to receiver input, as shown in this high-speed tracking system.

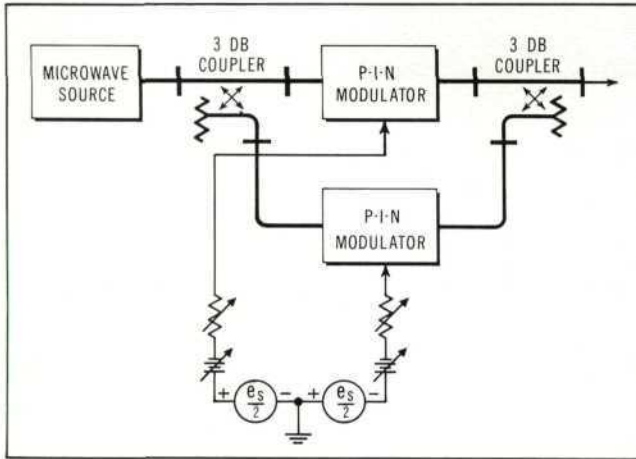

Figure 17. Two PIN Modulators function as balanced modulator by introduction of 180° phase-shift at carrier frequency in one of two parallel RF paths.

this signal is added to the signal from the other path, carrier cancellation takes place. In the balanced modulator, the two series resistors are chosen to equalize the sensitivities of the PIN Modulators, and dc bias voltages are set to provide approximately 7 db of attenuation.

Extremely narrow pulses can be generated by two modulators in series. A single PIN Modulator driven by the Modulator-driver is limited to 100-ns pulse widths because of internal recovery times in the driver.

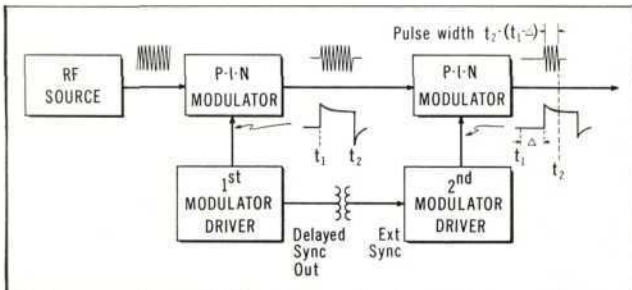

Figure 18. Two PIN Modulators in series achieve short-pulse widths by overlapping pulse "on" times.

This limitation is overcome in the set-up of Figure 18, which passes RF power only when both modulators are "on". The leading edge of the RF pulse therefore occurs when the second Modulator turns on and trailing edge occurs when the first Modulator turns off. Pulse width is determined both by the width setting of the first Modulator and the delay setting of the second. The repetition rate and pulse delay of the composite signal can be varied by the controls of the first Modulator.

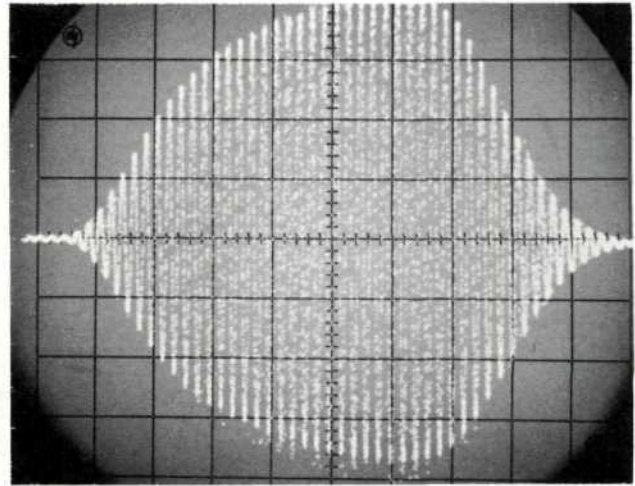

Figure 19. Short RF pulse achieved with tandem modulator shown in Figure 18. RF carrier: 1000 Mc; sweep rate: 5 nsec/cm. Phase coherent pulse is obtained by using RF carrier as sync input to sampling oscilloscope; counted-down sync from scope then triggers first modulating pulse generator.

CONCLUSION

The PIN diode as a microwave modulator overcomes many of the drawbacks of present modulation systems. The diode reduces reflections by absorbing power and improves spectral purity by permitting the source to operate continuously. Thus the PIN diode is the heart of a true advance in the technique of microwave modulation.