

Interconnecting Two or More 5180A Waveform Recorders to Obtain Multiple Input Channels

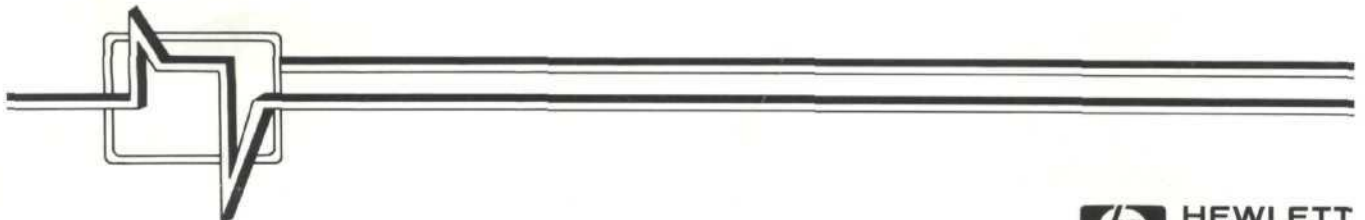



TABLE OF CONTENTS

INTRODUCTION	1
Timebase Considerations	1
Triggering Considerations	1
Organization of this Note	2
TIMEBASE SYNCHRONIZATION	3
Approximate Timebase Synchronization Requiring Least Equipment	3
Improving on the Approximate Timebase Synchronization	4
Precise Timebase Synchronization Requiring More Equipment	5
TRIGGERING METHODS	7
First 5180A Provides External Trigger Signal to Subsequent 5180A	7
All 5180As Receive Same External Trigger Signal	7
Additional Considerations If Sampling Rate is Less Than Timebase Rate	8
SYSTEM SETUP FOR TESTING	9
Test Setup When One 5180A Provides Timebase to the Next 5180A	9
Test Setup When Both 5180As Receive Timebase from Synthesizer	10
SYSTEM TESTING SOFTWARE: DESCRIPTION AND USE	11
Program #1A: Phase Setup for Testing Timebase Synchronization at the Timebase Sampling Rate	11
Program #1B: Phase Setup for Testing Timebase Synchronization at Sampling Rates Below the Timebase Rate	13
Program #2: Time Difference Measurement Between Samples from Two 5180A	15
Program #3: Testing for Consistency of Triggering in two Synchronized 5180A	17
RESULTS	19



INTRODUCTION

Many applications for waveform recorders require simultaneous sampling of two or more waveforms. For example, an electrical stimulus and the response to this stimulus may need to be recorded at the same time. In application areas such as explosive or structural testing, several output signals may occur simultaneously; in these cases, several signals must be sampled synchronously and recorded. To meet the need for recording more than one waveform at the same time, it's possible to interconnect two (or more) 5180A Waveform Recorders to obtain multiple input channels, each of which will sample an incoming waveform at a maximum 20 MHz rate. There are several ways of setting up for synchronous sampling, depending on how close in time samples must be.

These methods use various interconnections to provide timebase and triggering signals to the 5180As. Since both timebases and trigger points affect sample timing, both must be adjusted to obtain "simultaneous" samples with a known amount of time error.

Timebase Considerations

To insure that samples will be taken at the same frequency by two or more 5180As, the 5180A timebases must be locked together. However, there may be a time offset between the sample times of the 5180As, as shown in Figure 1. This note includes several equipment setups for synchronizing timebases, describes a method for reducing the time offset between simultaneous samples, and provides a technique for measuring how closely two 5180As are synchronized.

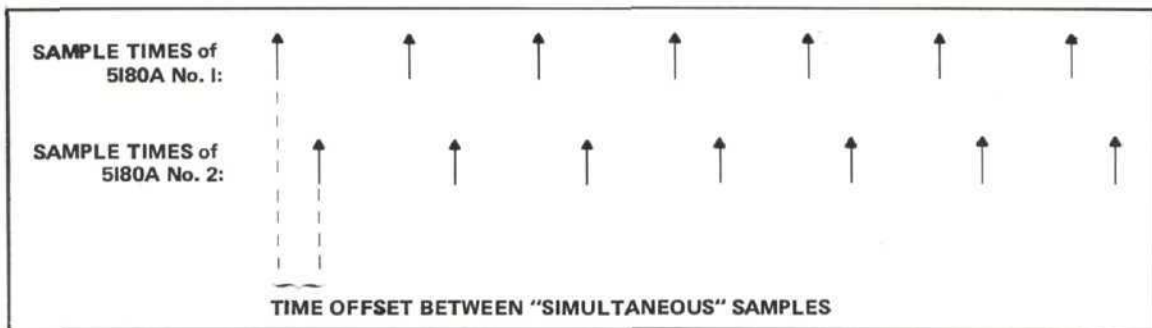

Figure 1. Synchronized 5180As sample at same rate, but there may be a time offset between "simultaneous" samples.

Triggering Considerations

The trigger location in each 5180A also affects how accurate sampling will be. If both 5180As recognize the trigger during the same sample interval (Figure 2A), the samples will be as close together in time as the timebase offset allows. If, on the other hand, the 5180As receive the trigger during different sample intervals (Figure 2B), there are two possibilities: 1) the time difference is known, and may be corrected for by shifting one 5180A's recorded data by a known number of samples; 2) the time difference is unknown or variable, and cannot be corrected for.

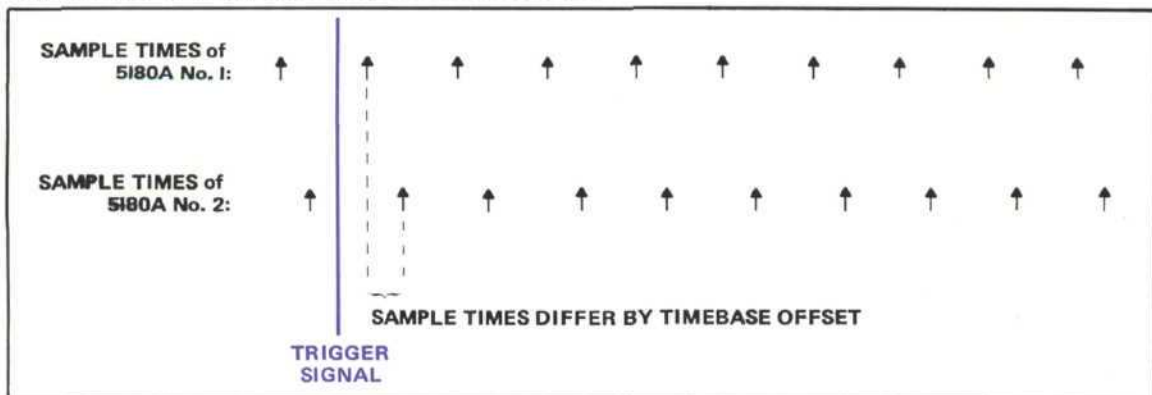

Figure 2A. 5180As recognize trigger during same sample interval; sample times differ by timebase offset.

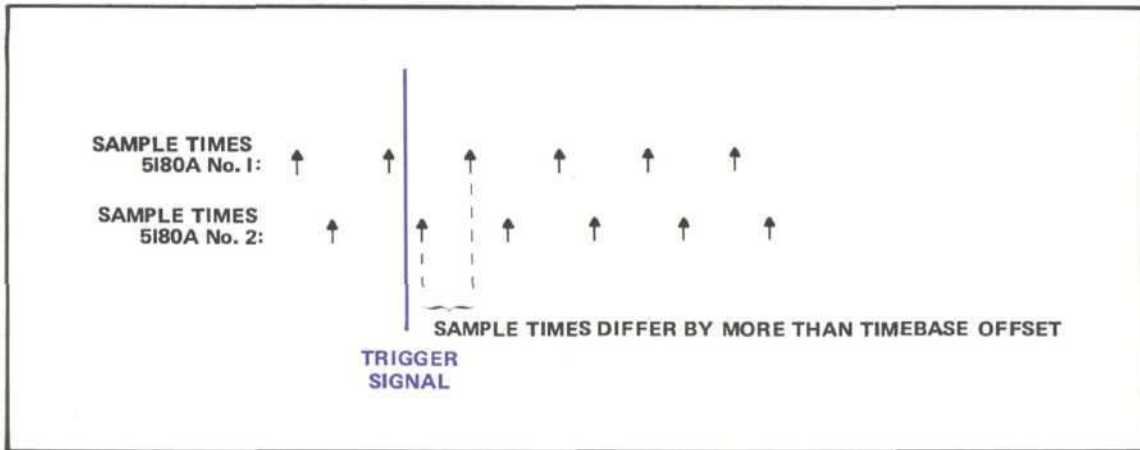

Figure 2B. 5180As recognize trigger during different sample intervals; time difference may be greater than timebase offset.

The likelihood of these possible outcomes depends on the triggering method used. The effectiveness of various triggering methods is described in the section entitled "Triggering Methods", beginning on page 7; a technique for measuring time difference between trigger points in two 5180As is provided in software. (See Program #3, page 17.)

Organization of this Note

This application note will discuss timebase synchronization first, then will describe triggering methods. Also, several programs are provided for system testing using BASIC on the HP 9826 Computer System. These include:

Program #1: Phase Setup for Testing Timebase Synchronization

Program #1 adjusts the phase of a test sinewave (which is synchronized with a 5180A timebase), so that the 5180A will sample the sinewave at the rising edge zero-crossing. Program #1A should be selected when sampling is at the rate of the internal or external timebase. If sampling is at a rate less than that of the timebase, a "sync" signal must be used. An appropriate signal is incorporated into Program #1B, where an HP 8112A Programmable Pulse Generator is added.

Program #2: Time Difference Between Samples

Program #2 compares voltage values of "simultaneous" samples, and calculates the average time difference between these samples. RMS time error is also calculated, to give a measure of consistency of the average time difference.

Program #3: Testing for Consistency of Triggering in two Synchronized 5180As

This routine tests how close in time the trigger occurs in two 5180As; when the timebases are synchronized and the first 5180A provides a trigger signal to the next, trigger delay is normally one sample interval.

TIMEBASE SYNCHRONIZATION

Approximate Timebase Synchronization Requiring Least Equipment

Two 5180As may be synchronized to sample incoming waveforms (and perform A/D conversions) approximately 20 ns apart, by simply interconnecting them with a 6 to 12 inch 50 Ω coax cable. To synchronize the 5180A timebases for this sampling method, the setup shown in Figure 3A should be used. This method may be easily extended to three 5180As, since each 5180A timebase output will drive up to two 5180A timebase inputs. (See Figure 3B).

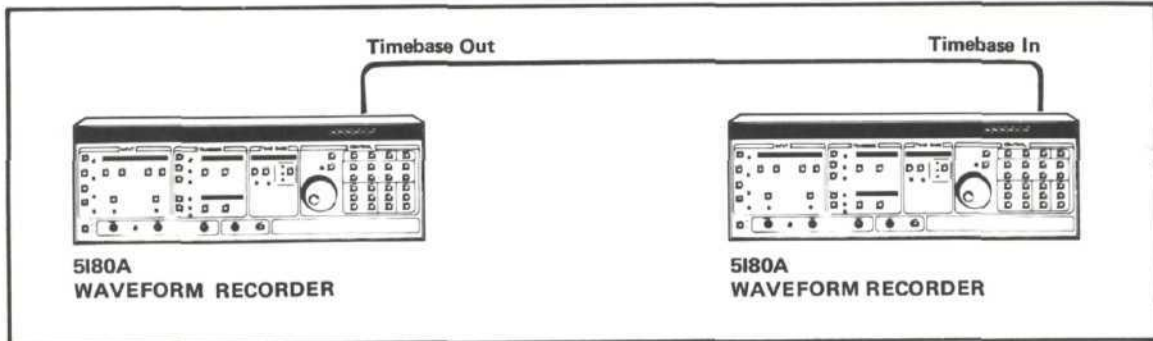

Figure 3A. First 5180A timebase output drives second 5180A timebase input.

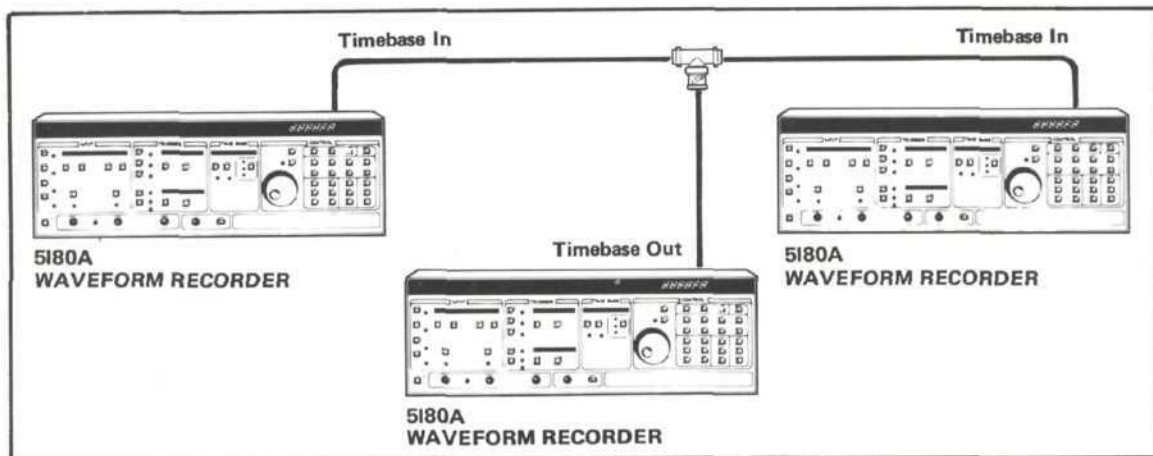

Figure 3B. One 5180A timebase output will drive two 5180A timebase inputs.

An alternative setup may be used for three or more 5180As. (See Figure 4). This method incurs a delay of about 20 ns for each successive 5180A. Consequently, the second 5180A in the series will sample 20 ns later than the first, the third will sample 40 ns later than the first, etc.

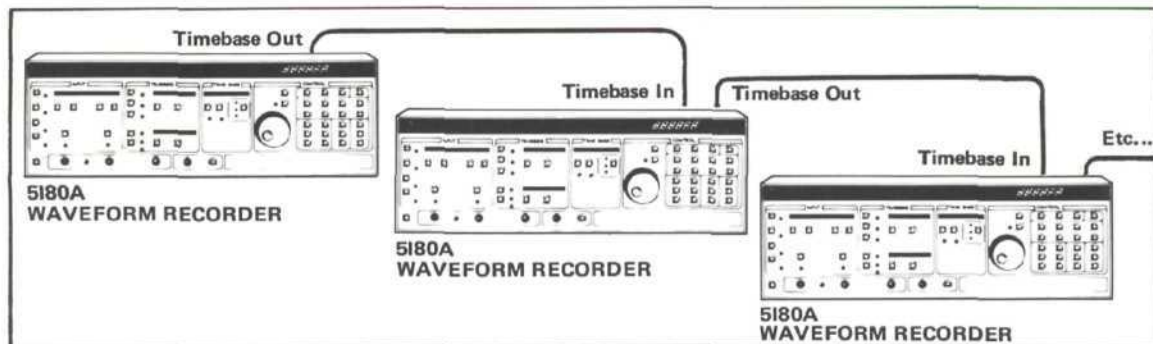

Figure 4. Three or more 5180As may receive timebase inputs in series, with a 20 ns delay for each successive 5180A.

Improving on the Approximate Timebase Synchronization

The method described for approximate synchronization may be noticeably improved by adding 50 Ω coax cable length to the permanent measurement setup. By increasing the length of cable interconnecting the two 5180A timebases, the second 5180A timebase may be delayed until it is again in phase with the first 5180A timebase, reducing the time error considerably. (See Figure 5).

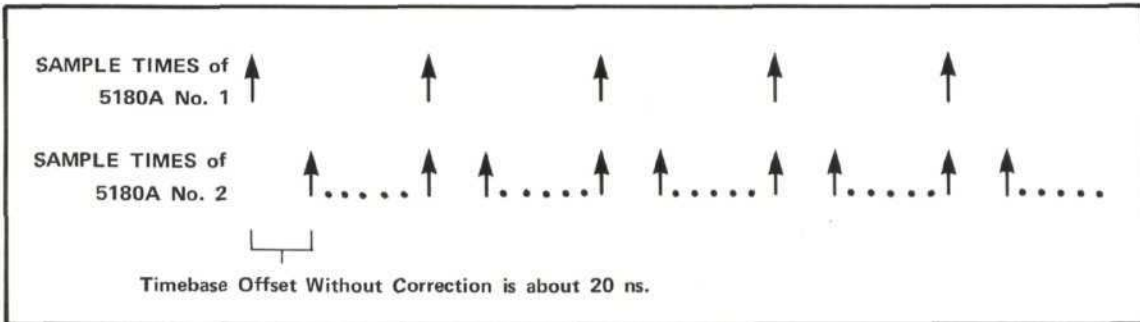

Figure 5. By delaying the second 5180A timebase an additional 30 ns, the timebase offset may be considerably reduced.

The equipment setup and software described later in this note may be used to test timebase synchronization following each cable adjustment. Program #1 aligns the phase of the test sinewave so that the first 5180A samples the sinewave on the rising edge at the 0 volt level. If a minimum-length cable is used to interconnect the 5180A timebases, the second 5180A will sample the input sinewave about 20 ns later, near 0 volts on the falling edge. (See Figure 6). Increasing the cable length in one- or two-foot increments will cause the second 5180A to sample at more negative voltage levels on the falling edge of the test sinewave, then to sample at less negative voltages on the rising edge of the sinewave. When the cable is long enough, samples will occur at 0 volts on the rising edge of the test sinewave. Each foot of cable adds about 1.5 ns delay, so approximately 20 feet of cable are required for this adjustment. After the cable length has been adjusted, the external timebase and test signal synthesizer are no longer needed.

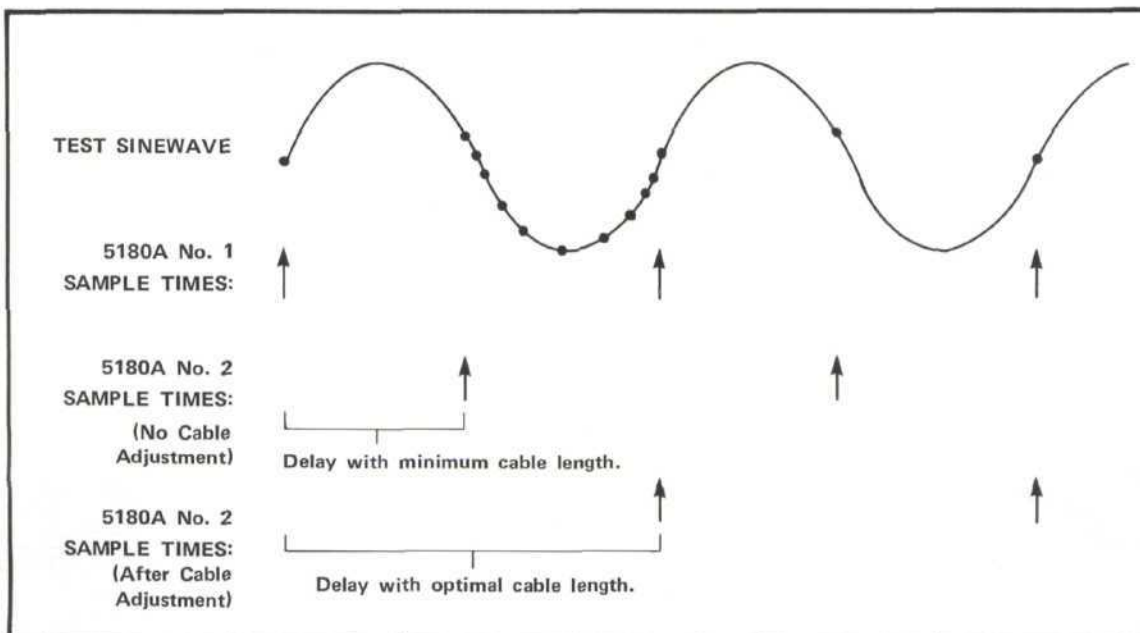

Figure 6. As the second 5180A timebase is delayed by increasing cable length between the first and second 5180A, voltage samples taken by the second 5180A will decrease to about -1.0 volt, then increase to 0 volts again.

Precise Timebase Synchronization Requiring More Equipment

For excellent synchronization of two 5180As with minimal setup effort, an HP 3325A, HP 3335A, or similar frequency synthesizer may be used to provide an external timebase signal. The synthesizer output should be set for maximum voltage output, then divided using a power splitter such as the HP 11667A or HP 11652-60009. The resulting timebase signals should then be sent (using matched 50 Ω coax cables) to the two 5180A timebase inputs. (See Figure 7). This method of synchronizing 5180A timebases may be extended to three or four 5180As, by adding power splitters as shown in Figures 8A and 8B.

Using a frequency synthesizer to provide external timebase signals in this manner allows 5180A sample times to be synchronized within about 300 ps. A technique for measuring how closely the timebases are synchronized is provided in Program #2.

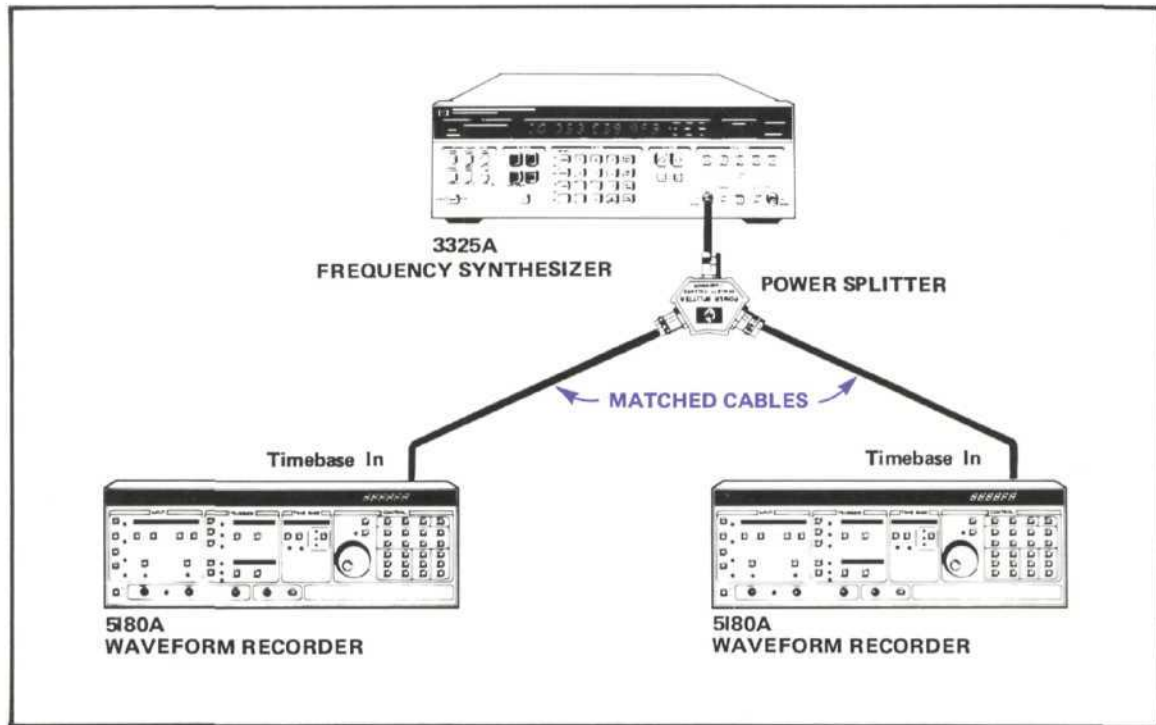

Figure 7. A frequency synthesizer such as the HP 3325A may be used to provide a precise timebase for two 5180As.

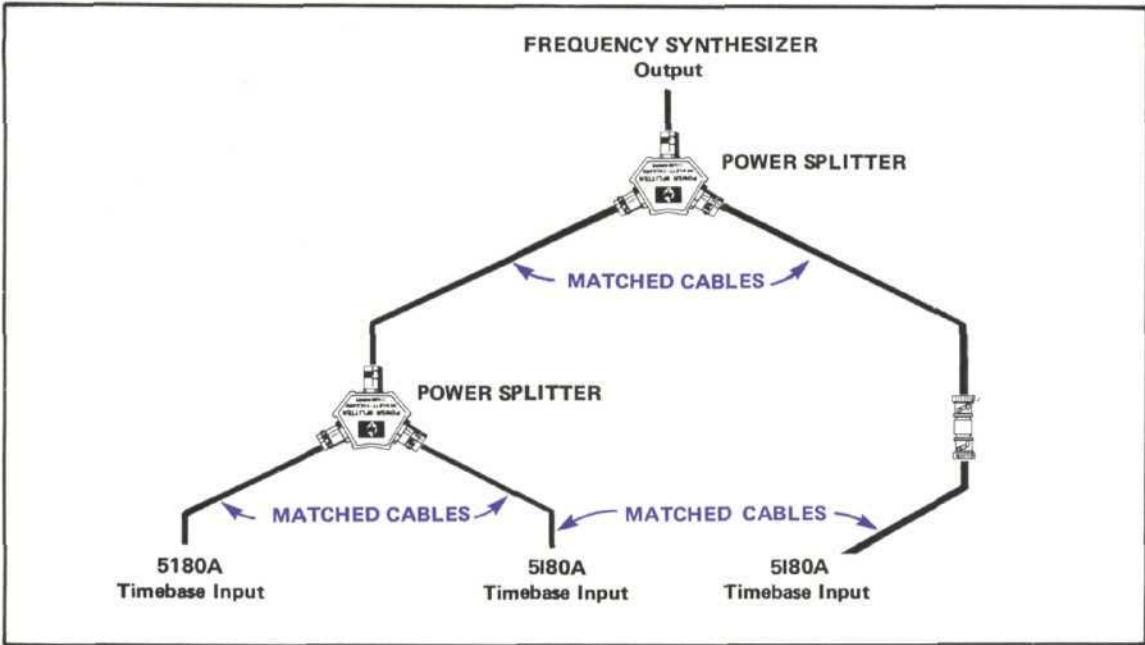

Figure 8A. Use two power splitters when a frequency synthesizer provides timebase for three 5180As.

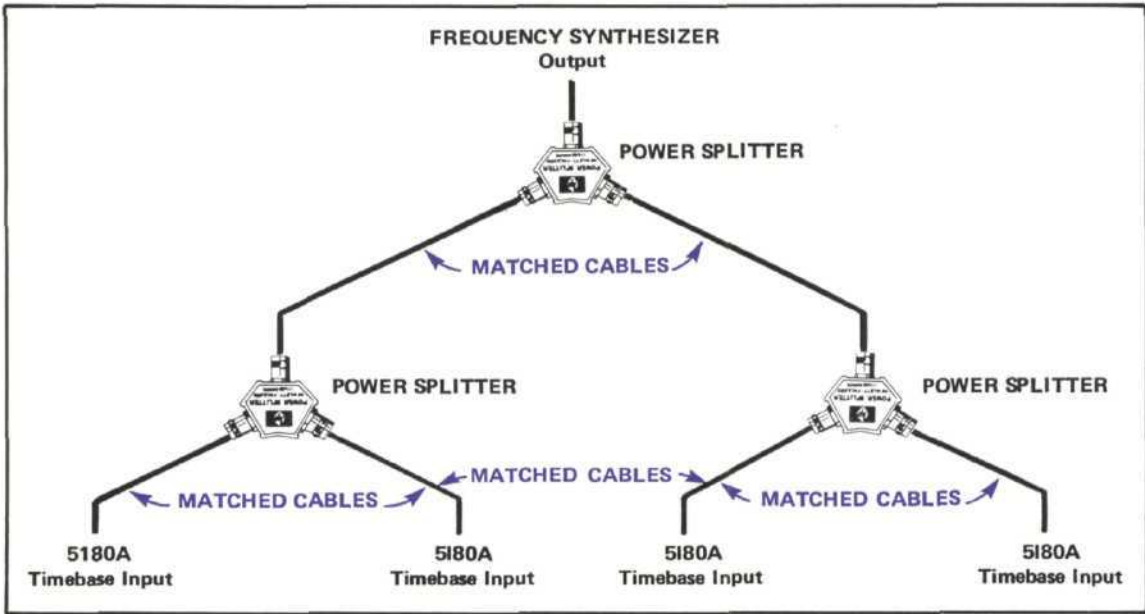

Figure 8B. A frequency synthesizer such as the HP 3325A will drive as many as four 5180As simultaneously by using three power splitters.

TRIGGERING METHODS

First 5180A Provides External Trigger Signal to Subsequent 5180As

The best way of triggering two synchronized 5180As is to trigger the first 5180A internally (based on the input waveform). The trigger output from this 5180A should then be used to trigger the next 5180A. (See Figure 9). Note that a 50 ohm feed-through (HP Part #10100C) must be used on the 5180A external trigger input when a 50 ohm signal (such as the 5180A trigger output) is used to provide a trigger. In addition, triggering conditions should be set for rising slope, and -0.3 volt trigger level. This setup may be extended for more than two 5180As; the trigger output from each 5180A may be used to trigger the next 5180A. When this method is used, there is normally a one sample interval delay between the trigger point in the first 5180A and that in the next 5180A.

A one sample interval delay between two trigger points may be corrected for by shifting the stored data one sample point. This shifting may be performed automatically, in advance, by selecting an absolute location as a trigger position; the 5180A with the earlier trigger should be assigned to trigger at position X, and the 5180A with the later trigger assigned to trigger at position X-1. For example, the 5180A receiving the earlier trigger may be assigned to trigger at location 0 by sending the command "PA0". The other 5180A should then be assigned to trigger at location -1 by sending the command "PA-1". This correction is possible only when a controller is used to remotely program the 5180A.

If the first 5180A is triggered externally, instead of internally, there is normally a one sample interval delay between the trigger point in the first 5180A and that in the second 5180A. However, there may occasionally be a one sample interval ambiguity in the second 5180A's trigger location. The probability of this ambiguity occurring may be determined by running Program #3 many times using the external trigger signal under test, and measuring how often the trigger points differ by more or less than one sample interval.

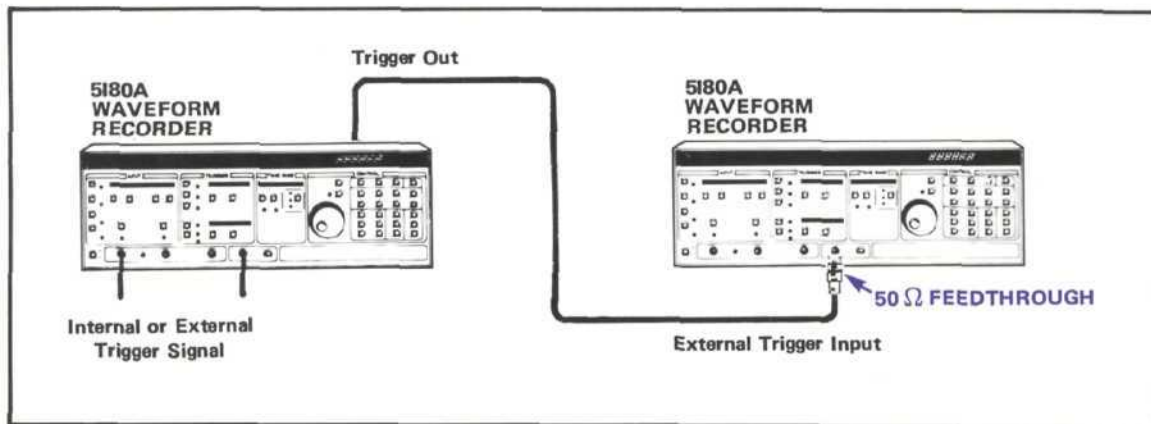

Figure 9. Trigger output from first 5180A provides external trigger signal to second 5180A.

All 5180As Receive Same External Trigger Signal

Another way of triggering synchronized 5180As is to connect the same signal to all external trigger inputs, and select the same triggering conditions. (See Figure 10). This will usually cause the 5180As to trigger during the same sample interval. However, there may occasionally be a one sample interval difference, if the trigger point is near the edge of a sample interval.

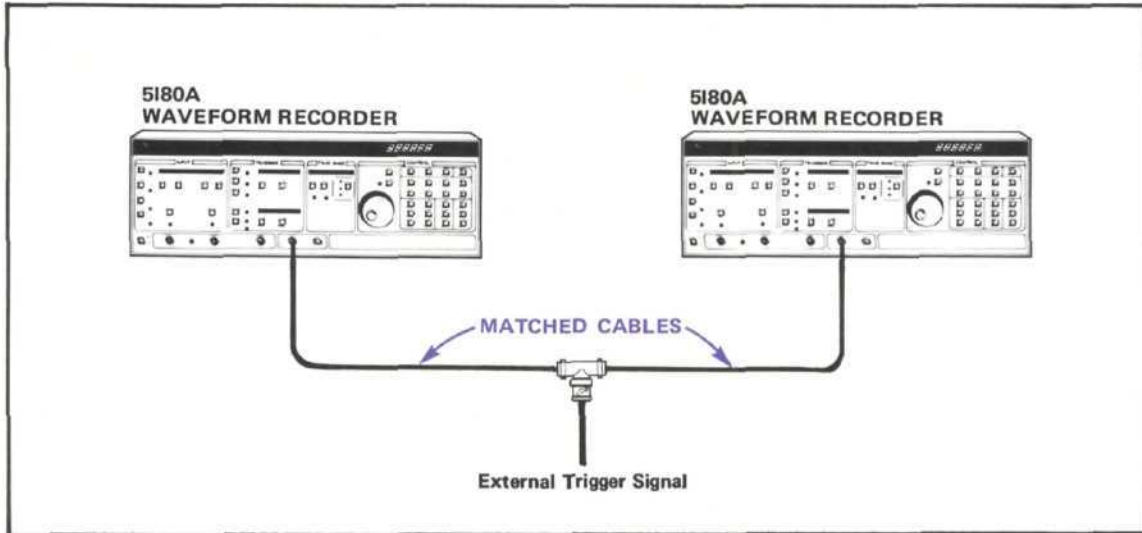

Figure 10. Two synchronized 5180As may be set for the same trigger conditions and triggered based on the same external trigger signal.

Additional Considerations If Sampling Rate is Less Than Timebase Rate

When two or more 5180A timebases are locked together and the time offset is acceptable, the two will sample synchronously if both are set to sample at the internal timebase rate (20 MHz) or at the rate of a shared external timebase (1 to 20 MHz). In this case, the selected sampling rate is the same as the timebase rate and the two 5180As will necessarily store simultaneous samples into memory. However, if a sampling rate less than the timebase rate is selected, the 5180As will continue to digitize the incoming waveform at the timebase rate, but will select 1 of N output samples from the A/D converter to store in memory, where N depends on the selected sampling rate. If, for example, the (internal or external) timebase is 20 MHz, and the selected sampling rate is 10 MHz, then each 5180A must select 1 of 2 samples from the A/D converter to store in memory. Setting both 5180As for the same sampling rate causes them to select the same "division factor", N, but does not ensure that they will record the same 1 of N samples. To ensure that the 5180As will select samples which are simultaneous (see Figure 11), a "sync" pulse must be sent to all 5180As simultaneously before beginning to make measurements. The sync pulse should be a single pulse, with a minimum width of at least 10 times the sample time. In the example above, where the sampling rate is 10 MHz, the sample interval is 100 ns, so the minimum sync pulse width is 1 μ s.

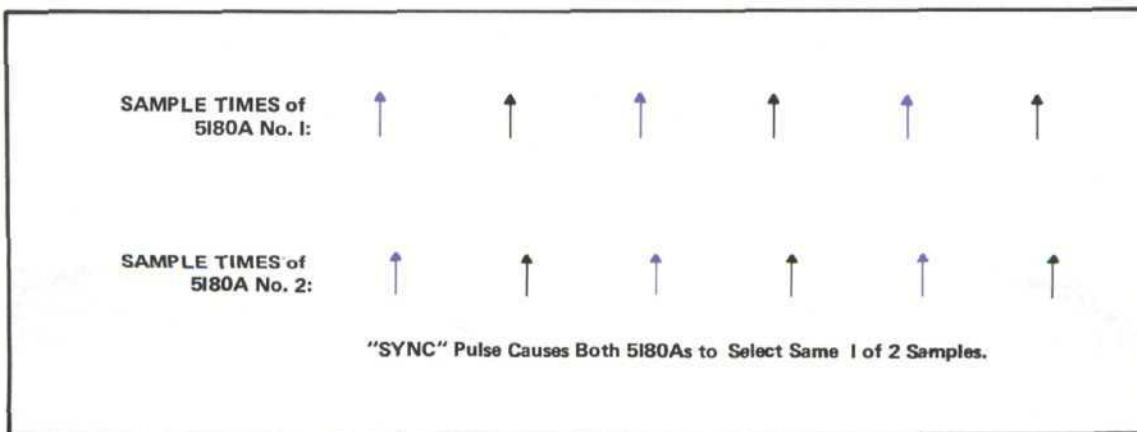

Figure 11. Use "sync" pulse to cause both 5180As to select same 1 of N samples, when sampling rate is less than timebase rate. Samples indicated in color are stored in the 5180A memory.

SYSTEM SETUP FOR TESTING

Begin by setting up the equipment to provide timebases and trigger signals in the selected manner. The software provided will test timebase synchronization and trigger time difference for two 5180As, which should be set for HP-IB addresses 704 and 705. If more than two 5180As are synchronized, the first may be set to address 704 and compared to the others one-at-a-time.

For system testing, a frequency synthesizer such as the HP 3325A or HP 3335A is required. (The software following is written for an HP 3325A with HP-IB address 717.) Set the test signal frequency synthesizer for a 1 volt range and the same frequency as the selected sampling rate. When a sampling rate less than the timebase rate is used, the test frequency should still be the same as the sampling rate. In addition, if a sampling rate lower than the timebase rate is needed, a pulse generator such as the HP 8112A must be used to synchronize the 5180As, as described previously. The pulse generator should be connected into the system as shown in Figure 12. (The software is written for an HP 8112A with address 712.)

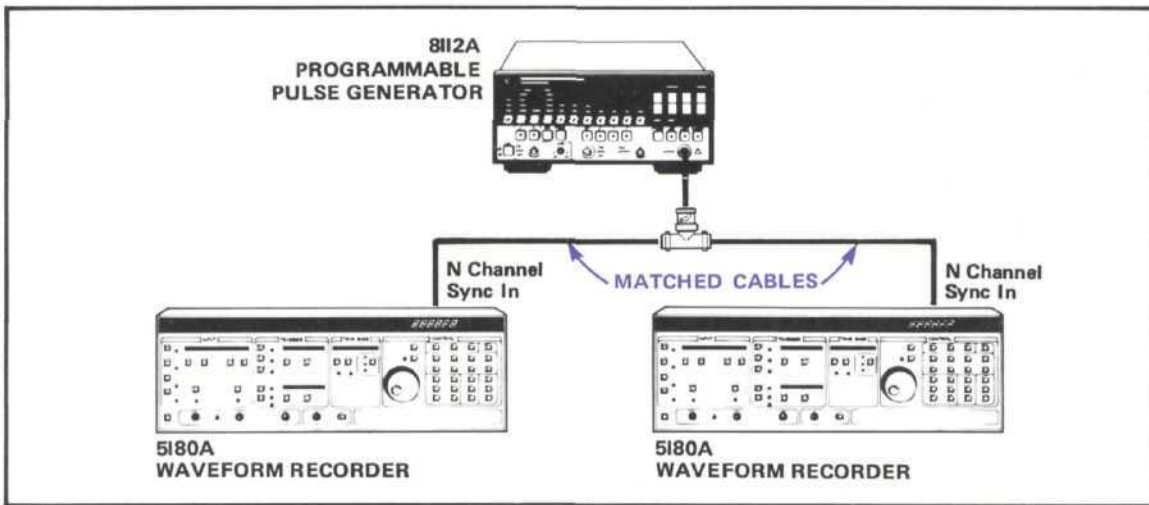

Figure 12. A sync pulse input is needed to synchronize two 5180As when the sampling rate is less than the timebase rate.

Test Setup When One 5180A Provides Timebase to the Next 5180A

The 5180As and test synthesizer must be synchronized for system testing. There are two possible ways of doing this, when one 5180A is providing a timebase for the next 5180A. One method requires no additional equipment beyond the test synthesizer, and allows timebase synchronization for a 10 MHz timebase only. This means that the cable length may be tested and adjusted for optimal timebase synchronization at 10 MHz. The equipment setup for this test is shown in Figure 13.

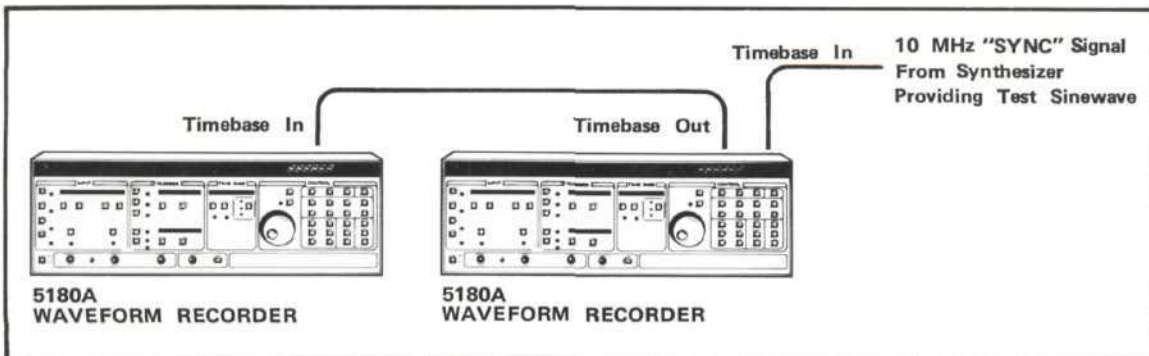

Figure 13. To save equipment, the "sync" output signal from the synthesizer providing the test sinewave may be used as a 10 MHz timebase for the 5180A.

An alternative equipment setup which will allow timebase synchronization testing for all timebase rates from 1 to 20 MHz is shown in Figure 14. This method requires an additional frequency synthesizer to drive the first 5180A timebase, so that the timebase rate is selectable. Synchronizing the test signal and the 5180A timebase is accomplished by connecting the timebase input from the 5180A timebase synthesizer to the timebase input on the test signal synthesizer.

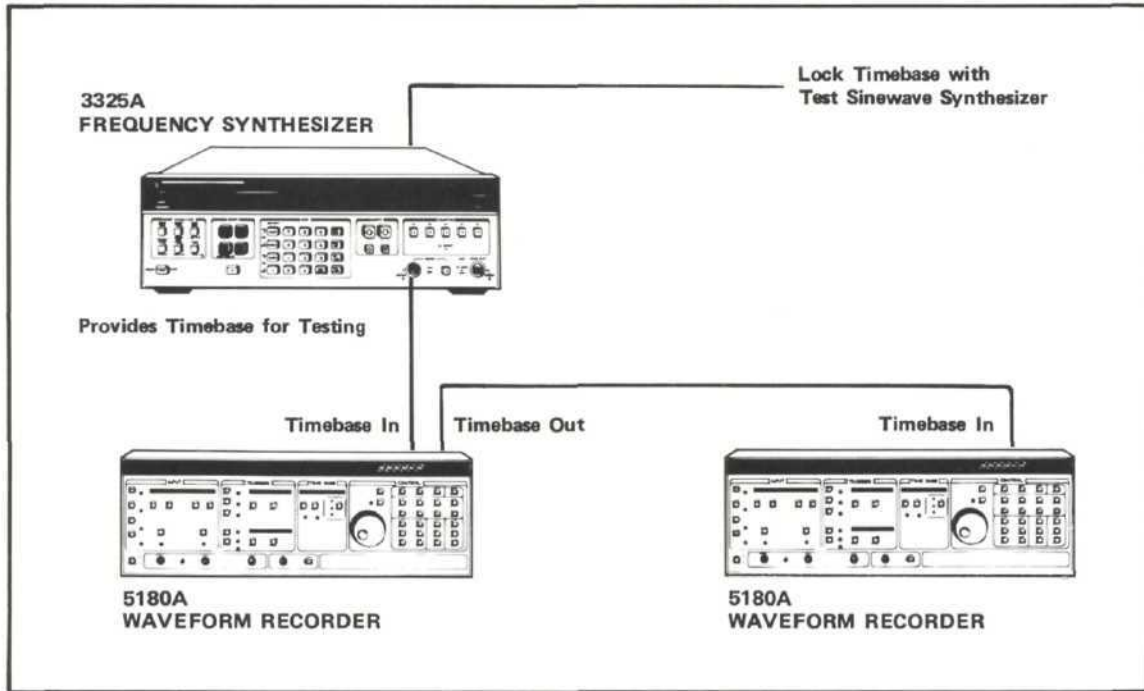

Figure 14. An additional frequency synthesizer may be used to allow testing of synchronization at any frequency between 1 and 20 MHz.

Test Setup When Both 5180As Receive Timebase from Synthesizer

When both 5180A timebases are driven by an external synthesizer, the timebase output from the synthesizer providing the 5180A timebases should be connected to the timebase input on the synthesizer providing the test signal.

If this setup is used, the synthesizer providing the 5180A timebases may be set for any frequency from 1 to 20 MHz; the maximum available voltage range should also be selected. When a 5180A receives a sinewave signal (without DC offset) as a timebase input, external timebase should be selected on the 5180A back panel, and the back panel timebase level switch should be set for position "3".

When one 5180A provides the timebase for a second 5180A, the back panel switch on the second 5180A should be set for external timebase, and the back panel timebase level selector should be in position "2".

SYSTEM TESTING SOFTWARE: DESCRIPTION AND USE

An HP-IB compatible printer may be used with these test programs to record outputs from the 9826. If, for example, a printer with HP-IB address 701 is used, the command "PRINTER IS 701" should be executed before the test programs are run.

Program lines which require user input or which print output values are shown in color for easy reference.

Program #1A: Phase Setup for Testing Timebase Synchronization at the Timebase Sampling Rate

After the test frequency synthesizer is set up as shown in Figure 15, it's necessary to adjust the phase of the test signal until sampling occurs at the rising edge zero-crossing of the signal. This program iteratively adjusts the phase of the test signal until the best possible sampling position is located. If a frequency synthesizer other than the HP 3325A is used, some program codes need to be changed.

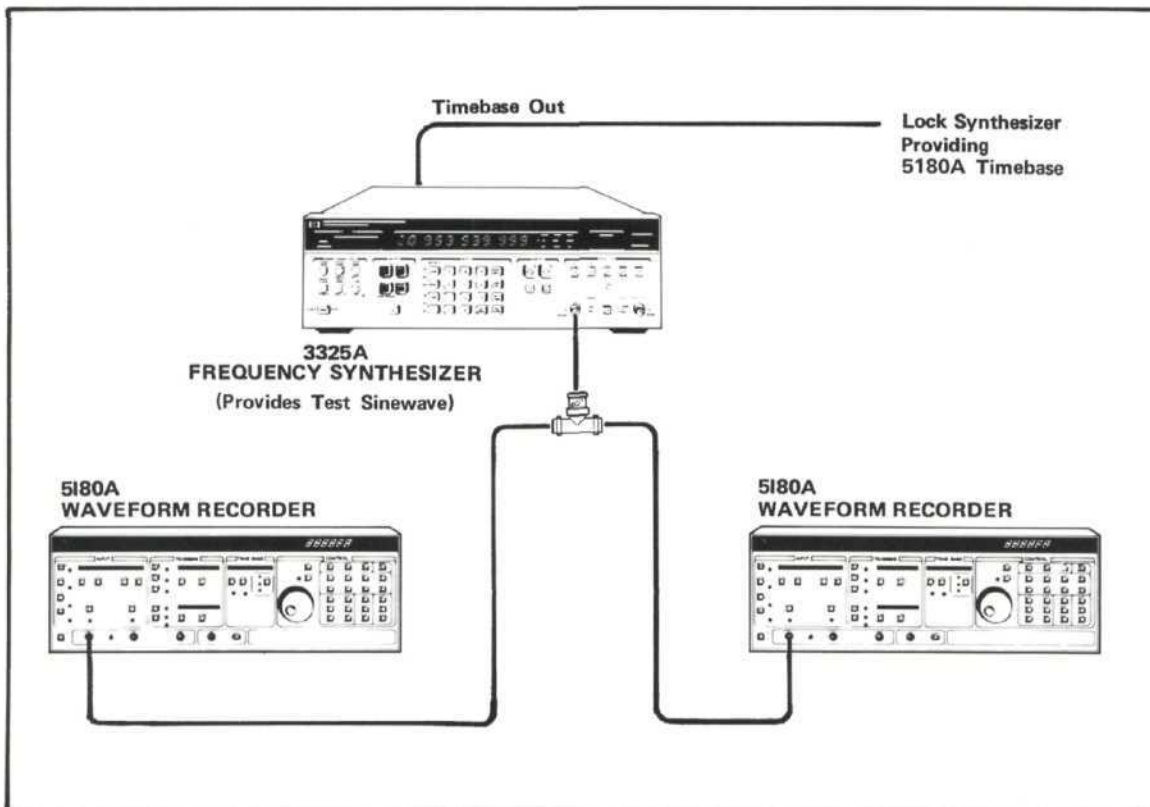

Figure 15. Connect the frequency synthesizer providing the test sinewave as shown. Lock the timebase of test signal synthesizer to the 5180A, either by connecting to the synthesizer providing the 5180A timebase, or to the 5180A directly, if no synthesizer is used.

Program #1A: Phase Setup for Testing Timebase Synchronization at the Timebase Sampling Rate

```
10 !PROGRAM #1A 10.28.82
20 DIM A$(28)
30 !PROGRAM ASSUMES 5180S IN SYNC; ADJUSTS PHASE FOR #704
40 REMOTE 704 !5180 IS #704
50 REMOTE 717 !FREQ SYNTHESIZER IS #717
60 OUTPUT 704;"PR,AR1,SA1,PP0,LP0"
70 OUTPUT 704;"SEL,TEL,CU512,CV1"
80 P1=0
90 OUTPUT 717;"PH0.0DE"
100 GOSUB Calc
110 !IF SAMPLES ARE NEAR 0V, PHASE IS ACCEPTABLE
120 IF ABS(V1)<=.006 THEN GOTO 380
130 !IF SAMPLES ARE NOT NEAR 0V, CHANGE PHASE ACCORDINGLY
140 IF V1>.006 THEN A1=1
150 IF V1<-.006 THEN A1=-1
160 !IF SAMPLES NOT NEAR 0V, ADJUST PHASE IN 10 DEG STEPS
170 P1=P1+10*A1
180 OUTPUT 717;"PH",P1,"DE"
190 GOSUB Calc
200 IF ABS(V1)<=.006 THEN GOTO 380
210 A2=V1/ABS(V1)
220 IF A1<>A2 THEN GOTO 240
230 GOTO 170
240 !IF SAMPLES NOT NEAR 0V, ADJUST PHASE IN 1 DEG STEPS
250 P1=P1-A1
260 OUTPUT 717;"PH",P1,"DE"
270 GOSUB Calc
280 IF ABS(V1)<=.006 THEN GOTO 380
290 A3=V1/ABS(V1)
300 IF A1=A3 THEN GOTO 320
310 GOTO 250
320 !IF SAMPLES NOT NEAR 0V, ADJUST PHASE IN .1 DEG STEPS
330 P1=P1+(.1*A1)
340 OUTPUT 717;"PH",P1,"DE"
350 GOSUB Calc
360 IF ABS(V1)<=.006 THEN GOTO 380
370 GOTO 320
380 DISP "P1=";P1 !P1 IS SELECTED PHASE
390 GOTO 510
400 Calc:
410 OUTPUT 704;"SA4"
420 WAIT 1
430 OUTPUT 704;"MT"
440 OUTPUT 704;"OG"
450 ENTER 704;A$
460 P=POS(A$,"d2")+2
470 IF A$(P+8;1)=" " THEN A$(P+8;1)="+"
480 V1=VAL(A$(P))
490 DISP "V1=";V1
500 RETURN
510 END
```

Program #1B: Phase Setup for Testing Timebase Synchronization at Sampling Rates below the Timebase Rate

This program (following page) should be used instead of Program #1A to adjust the phase of the input sinewave, when sampling is at a lower rate than the timebase rate. Adjusting the phase of the frequency synthesizer is slightly more complicated when the sampling rate is less than the 5180A timebase rate. This is because the 5180A continues to digitize the incoming waveform at the timebase rate, but then selects 1 of N outputs from the A/D converter to store in memory, as described on page 8.

A sync pulse is sent automatically, if this program is used and the sync pulse is provided by an 8112A Programmable Pulse Generator. Following the sync pulse, the program automatically adjusts the phase of the input signal so that sampling occurs at the rising edge zero-crossing of the signal. Otherwise, this program is similar to Program #1A.

Program #1B: Phase Setup for Testing Timebase Synchronization at Sampling Rates Below the Timebase Rate

```

10  !PROGRAM #1B      10.28.82
20  ASSIGN @adc TO 704,705 !PROGRAM ASSUMES TEST OF TWO 5180S
30  REMOTE @adc !ASSIGNS BOTH 5180S TO REMOTE OPERATION
40  REMOTE 712
50  REMOTE 717
60  DIM A$(28)
70  OUTPUT @adc;"PR,AR1,SA1,PP0,LP0,SE1,TE1,CU512,CV1" !SET UP BOTH 5180S
80  INPUT "FREQUENCY OF TEST SINEWAVE IN MHZ?",S1
90  PRINT "TEST FREQUENCY =" ;S1;"MHZ"
100 M1=1/(S1*1000000)
110 OUTPUT @adc;"MM",M1
120 DISP "INPUT SINEWAVE TO 5180S"
130 WAIT 1 !NOW SET UP 712 FOR 10V PULSE
140 OUTPUT 712;"M2,T1,PER1MS,DEL65NS,W1,HIL10.0V,LOLOV,L0,C0,D0"
150 M2=1.E+7*M1
160 OUTPUT 712;"WID",M2,"US" !SELECT PULSE WIDTH= 10X SAMPLE INTERVAL
170 WAIT 1
180 TRIGGER 712 !SEND SYNC PULSE TO 5180S
190 P1=0
200 !BEGIN PHASE ADJUSTMENT ROUTINE
210 OUTPUT 717;"PH0.0DE"
220 GOSUB Calc
230 !IF SAMPLES ARE NEAR 0V, PHASE IS ACCEPTABLE
240 IF ABS(V1) <=.006 THEN GOTO 490
250 !IF SAMPLES NOT NEAR 0V, ADJUST PHASE IN 10 DEG STEPS
260 IF V1 >.006 THEN C1=1
270 IF V1 <-.006 THEN C1=-1
280 P1=P1+10*C1
290 OUTPUT 717;"PH",P1,"DE"
300 GOSUB Calc
310 IF ABS(V1) <=.006 THEN GOTO 490
320 C2=V1/ABS(V1)
330 IF C1 <> C2 THEN GOTO 350
340 GOTO 280
350 !IF SAMPLES NOT NEAR 0V, ADJUST PHASE IN 1 DEG STEPS
360 P1=P1-C1
370 OUTPUT 717;"PH",P1,"DE"
380 GOSUB Calc
390 IF ABS(V1) <=.006 THEN GOTO 490
400 C3=V1/ABS(V1)
410 IF C1=C3 THEN GOTO 430
420 GOTO 360
430 !IF SAMPLES NOT NEAR 0V, ADJUST PHASE IN .1 DEG STEPS
440 P1=P1+.1*C1
450 OUTPUT 717;"PH";P1;"DE"
460 GOSUB Calc
470 IF ABS(V1) <=.006 THEN GOTO 490
480 GOTO 430
490 DISP "P1=" ;P1 !P1 IS SELECTED PHASE
500 GOTO 610
510 Calc: !FINDS VOLTAGE LEVEL OF SAMPLES
520 OUTPUT @adc;"SA4"
530 WAIT 1
540 OUTPUT @adc;"MT"
550 OUTPUT 704;"OG"
560 ENTER 704;A$
570 P=POS(A$,"d2")+2
580 IF A$[P+8;1]=" " THEN A$[P+8;1]="+"
590 V1=VAL(A$[P])
600 RETURN
610 END

```

Program #2: Time Difference Measurement Between Samples From Two 5180As

After setting up the equipment and running the first two programs, this program (following page) will test how closely two 5180As are synchronized. The 5180As' sampling rates and the frequency of the input sinewave should be the same, as in Program #1. This program takes 1024 voltage samples from each 5180A, and determines the average voltage difference. Since Program #1 adjusts the input sinewave phase so that sampling occurs at the 0 volt level, and the slew rate of the sinewave is known at this point, the average time difference between "simultaneous" samples may be calculated.

The recorded results from two 5180As simultaneously sampling a 20 MHz sinewave at the rising edge zero-crossing are shown superimposed in Figure 16. The two 5180As are synchronized to within 200ps, so the voltage levels of samples from the two 5180As are indistinguishable in the plot.

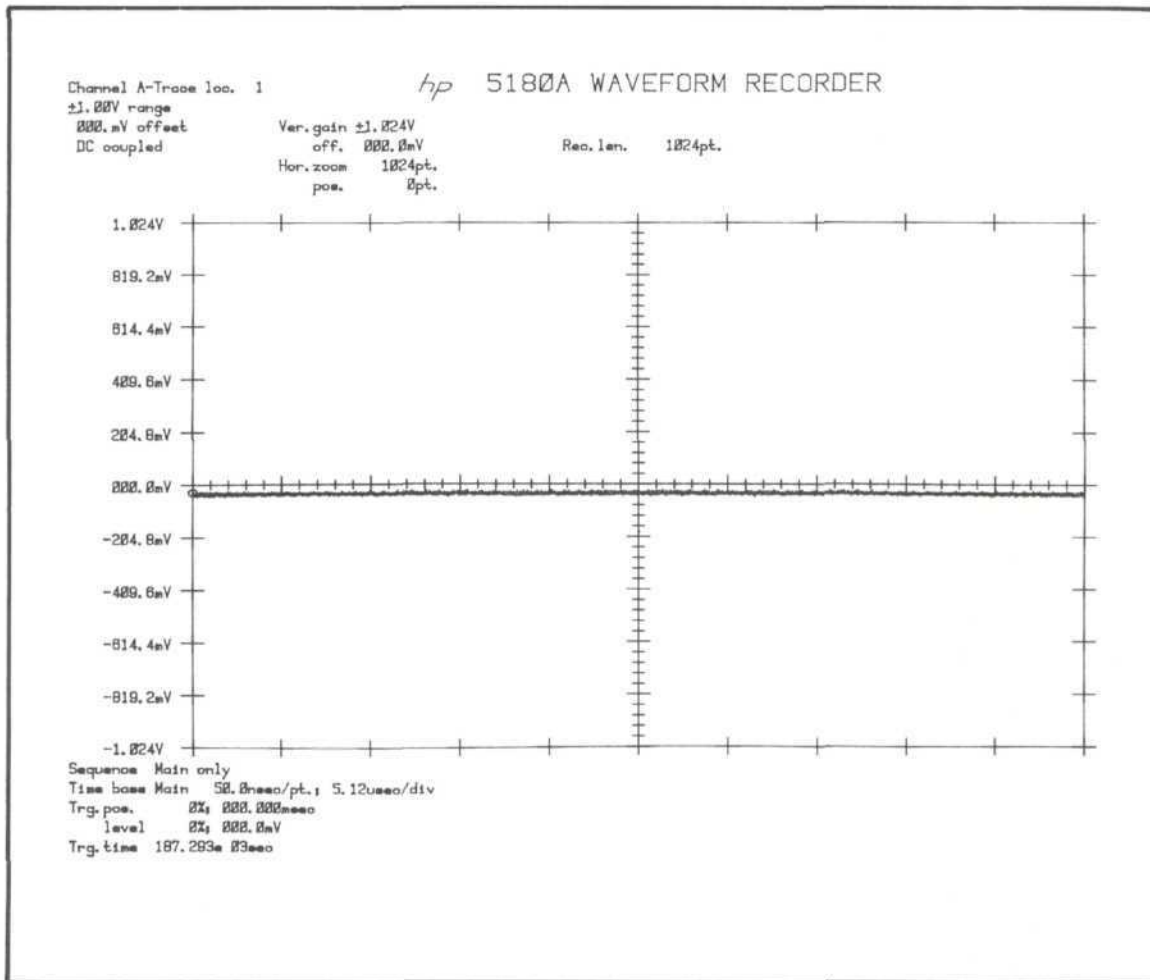

Figure 16. Superimposed plots show samples taken simultaneously by two synchronized 5180As.

Program #2: Time Difference Measurement Between Samples from Two 5180As

```
10  !PROGRAM #2      10.28.82
20  ASSIGN @Adc TO 704,705 !PROGRAM ASSUMES TEST OF TWO 5180S
30  REMOTE @Adc
40  OUTPUT @Adc;"PR,AR1,SA1,PP0,LP0,SE1,TE1"
50  INPUT "FREQUENCY OF TEST SINEWAVE IN MHZ?",S1
60  PRINT "TEST FREQUENCY =" ;S1;"MHZ"
70  WAIT 1
80  OUTPUT @Adc;"SA4"
90  WAIT 1
100 OUTPUT @Adc;"MT"
110 REAL A(1024),B(1024),C(1024)
120 OUTPUT 704;"BB1"
130 FOR J=0 TO 1023
140 ENTER 704 USING "#,B";A1
150 ENTER 704 USING "#,B";B1
160 A(J)=A1*32+B1/8
170 A(J)=(A(J)-512)*.002
180 NEXT J
190 !A(J) CONTAINS VOLTAGE SAMPLE VALUES FROM 5180 #704
200 OUTPUT 705;"EB1"
210 FOR J=0 TO 1023
220 ENTER 705 USING "#,B";A1
230 ENTER 705 USING "#,B";B1
240 B(J)=A1*32+B1/8
250 B(J)=(B(J)-512)*.002
260 NEXT J
270 !B(J) CONTAINS VOLTAGE SAMPLE VALUES FROM 5180 #705
280 !THE FOLLOWING ROUTINE COMPARES SAMPLES FROM 5180 #704 AND 5180 #705
290 A1=0
300 A2=0
310 FOR J=0 TO 1023
320 A1=A1+A(J)/1024
330 A2=A2+B(J)/1024
340 NEXT J
350 A1=ROUND(A1,3)
360 A2=ROUND(A2,3)
370 PRINT "A1=" ;A1;"VOLTS";" A2=" ;A2;"VOLTS"
380 D1=A2-A1 !D1=AVERAGE VOLTAGE DIFFERENCE BETWEEN #705 AND #704 DATA
390 E1=0
400 FOR J=0 TO 1023
410 C(J)=B(J)-D1-A(J)
420 E1=E1+C(J)^2
430 NEXT J
440 E1=(E1/1024)^.5
450 E1=ROUND(E1,3) !E1 IS RMS ERROR LEFT AFTER TAKING OUT D1 DIFFERENCE
460 PRINT "DELAY DIFFERENCE =" ;D1;"VOLTS"
470 PRINT "RMS NOISE ERROR =" ;E1;"VOLTS"
480 !THE FOLLOWING ROUTINE CALCULATES TIME DIFFERENCE BASED ON D1 VALUE
490 T1=D1/(2*PI*S1*1000000)
500 T1=ROUND(T1,3) !T1 IS AVERAGE TIME DELAY BETWEEN #704 AND #705 SAMPLES
510 T2=E1/(2*PI*S1*1000000)
520 T2=ROUND(T2,3) !T2 IS RMS ERROR TIME BETWEEN #704 AND #705 SAMPLES
530 PRINT "DELAY DIFFERENCE =" ;T1;"SECONDS"
540 PRINT "RMS NOISE DIFFERENCE =" ;T2;"SECONDS"
550 INPUT "1 TO CONT., 0 TO STOP",N
560 IF N=0 THEN GOTO 580
570 GOTO 80
580 END
```

Program #3: Testing for Consistency of Triggering in Two Synchronized 5180As

This program measures the time difference between trigger points in two 5180As. To allow a one or two sample interval delay to be visible, the frequency of the input sinewave should be much lower than the sampling rate. For example, if a 20 MHz sampling rate is used, the input sinewave should be 1 MHz. In this program, trigger position 0 is selected, so the first sample stored in memory location 0 in both 5180As will be the trigger point. The voltage values at the trigger points are compared, and the time difference calculated based on the slew rate of the input sinewave.

This program may be run iteratively to determine whether the time between two trigger points is consistent, or if not, how often it varies. If the time difference is inconsistent, the results of running this program many times will give a measure of probability of error.

Normally, when the trigger output from one 5180A externally triggers a second 5180A, the two record the same input signal with a one sample interval offset. Two recorded sinewaves are shown superimposed in Figure 17; the two trigger points are marked by cursors. The trigger point offset could be corrected for by selecting absolute trigger position as described in the Triggering Methods section, on page 7.

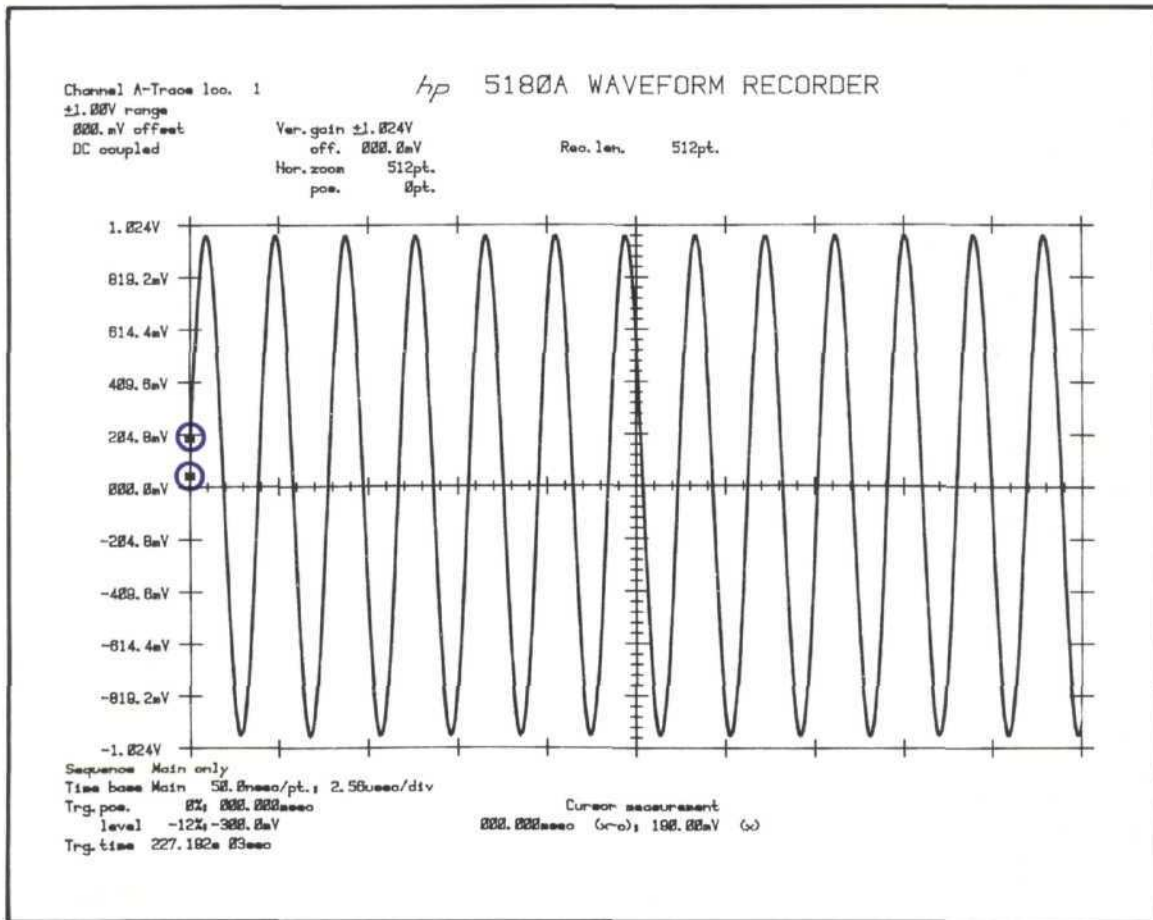

Figure 17. Trigger point time difference for two 5180As may be calculated based on voltage difference between the two trigger points (circled). Superimposed plots show this voltage difference graphically.

Program #3: Testing for Consistency of Triggering in Two Synchronized 5180As

```
10 !PROGRAM #3 10.28.82
20 DIM A$(28),B$(28)
30 ASSIGN @Adc TO 704,705
40 REMOTE @Adc !SETS_BOTH 5180S FOR REMOTE OPERATION
50 !SET UP #704, USE INTERNAL TRIGGER; FOR EXTERNAL TRIGGER, USE "SE1"
60 OUTPUT 704;"PR,AR1,SA1,PP0,SE0,LV-.1,TE1,CU0,CV1"
70 !SET UP #705, USE EXTERNAL TRIGGER (MAY RECEIVE SIGNAL FROM #704)
80 OUTPUT 705;"PR,AR1,SA1,PP0,SE1,LV-.3,TE1,CU0,CV1"
90 INPUT "FREQUENCY OF TEST SINEWAVE IN MHZ?",S1
100 PRINT "TEST FREQUENCY =" ;S1;"MHZ"
110 OUTPUT 705;"SA4"
120 OUTPUT 704;"SA4"
130 WAIT 1
140 S=SPOLL(705)
150 !WAIT FOR MEASUREMENT COMPLETE
160 IF BIT(S,4)=1 THEN GOTO 140
170 OUTPUT 704;"OG"
180 ENTER 704;A$
190 P=POS(A$,"d2")+2
200 IF A$(P+8;1)=" " THEN A$(P+8;1)="+"
210 !V1 IS VOLTAGE AT FIRST SAMPLE IN #704
220 V1=VAL(A$(P))
230 OUTPUT 705;"OG"
240 ENTER 705;B$
250 P=POS(B$,"d2")+2
260 IF B$(P+8;1)=" " THEN B$(P+8;1)="+"
270 !V2 IS VOLTAGE AT FIRST SAMPLE IN #705
280 V2=VAL(B$(P))
290 V1=DROUND(V1,3)
300 V2=DROUND(V2,3)
310 !SINCE TRIGGER IS ON RISING SLOPE, ASSUME HIGHER VOLTAGE IS LATER SAMPLE
320 V3=V2-V1
330 !CALCULATE TIME DIFFERENCE, BASED ON SLEW RATE OF INPUT SINEWAVE
340 T1=V3/(2*PI*S1)
350 T1=DROUND(T1,3)
360 PRINT "V1=";V1;" V2=";V2;" VOLTAGE DIFFERENCE=";V3;" TIME DELAY=";T1;"US"
370 INPUT "1 TO CONTINUE, 0 TO STOP",N
380 IF N=1 THEN GOTO 90
390 END
```

RESULTS

Program #1 (either A or B) adjusts the phase of the test signal so that the 5180As will sample the input sinewave at the rising edge zero-crossing. When the program ends, the selected phase (P1) is displayed by the 9826.

The results of Program #2 indicate how closely the timebases of two 5180As are synchronized. Figure 18 shows a typical printout obtained from this program. The "delay difference" measures the average voltage or time difference between samples taken by each of the two 5180As. The "rms noise error" is the random error affecting the measurement of time difference between samples.

```
TEST FREQUENCY = 20 MHZ
A1 = .305 VOLTS A2 = .334 VOLTS
DELAY DIFFERENCE = .029 VOLTS
RMS NOISE ERROR = .00394 VOLTS
DELAY DIFFERENCE = 2.31E-10 SECONDS
RMS NOISE DIFFERENCE = 3.14E-11 SECONDS
```

Figure 18. Printout resulting from Program #2.

Program #3 measures the time difference between two 5180As' trigger points, when both are recording the same input sinewave. The results of this test, when it is run using a 20 MHz sampling rate and 500 KHz test sinewave, are shown in Figure 19.

```
TEST FREQUENCY = 1 MHZ
V1= .0948 V2= .389 VOLTAGE DIFFERENCE= .2942 TIME DELAY= .0468 US
```

Figure 19. Printout of Program #3 results.

The results obtained using these tests provide a measure of both timebase and triggering error for two synchronized 5180As. If more than two 5180As are to be synchronized, each of the 5180As should be compared to one "control"; the time relationship of all the 5180As will then be known.



For more information, call your local HP Sales Office or nearest Regional Office: **Eastern** (201) 265-5000; **Midwestern** (312) 255-9800; **Southern** (404) 955-1500; **Western** (213) 970-7500; **Canadian** (416) 678-9430. Ask the operator for instrument sales. Or write Hewlett-Packard, 1501 Page Mill Road, Palo Alto, CA 94304. **In Europe:** Hewlett-Packard S.A., 7, rue du Bois-du-Lan, P.O. Box, CH 1217 Meyrin 2, Geneva, Switzerland. **In Japan:** Yokogawa-Hewlett-Packard Ltd., 29-21, Takaido-Higashi 3-chome, Suginami-ku, Tokyo 168.