

JULY 1972

APPLICATION NOTE 142
EMI
MEASUREMENT
PROCEDURE

Detailed Operating Information
for using the HP 8550 Series of
Spectrum Analyzers to Measure
Electromagnetic Interference

HEWLETT  PACKARD

APPLICATION NOTE 142 EMI MEASUREMENT PROCEDURE

Calibration and Operation of the HP 8550-Series of
Plug-in Spectrum Analyzers to Measure
Electromagnetic Interference per
the Methods of MIL-STD-461, 462.

COPYRIGHT HEWLETT-PACKARD COMPANY 1972
1501 PAGE MILL ROAD, PALO ALTO, CALIFORNIA, U.S.A.

CONTENTS

I	INTRODUCTION	1
	BACKGROUND	1
	BENEFITS	1
	HOW TO USE THIS APPLICATION NOTE	1
II	CALIBRATION OF MEASUREMENT EQUIPMENT	3
	CALIBRATING THE SPECTRUM	
	ANALYZER FOR dB μ V	3
	USING THE BANDWIDTH FACTOR (B) TO	
	CALIBRATE THE DISPLAY FOR BROADBAND	
	IMPULSE SIGNALS	3
	PROCEDURES FOR DETERMINING THE	
	BANDWIDTH FACTOR B (FOR USE WITH	
	THE LOGARITHMIC DISPLAY MODE)	4
	Method 1	5
	Method 2	5
	Method 3	6
	Method 4	6
III	LABELING AND MARKING THE DISPLAY	
	GRATICULE FOR PHOTOGRAPHY	11
IV	TEST PROCEDURES FOR MIL-STD-461, 462 METHODS	13
	1. METHOD CE01 CONDUCTED EMISSION,	
	30 Hz TO 20 kHz, POWER LEADS	13
	1.1 Instruments and Accessories Used	13
	1.2 Test Setup	13
	1.3 Control Settings and CRT Calibration	14
	1.4 Calibrating and Marking Display	15
	1.5 Frequency Calibration	17
	1.6 Precautions	17
	1.7 Signal Identification	18
	2. METHOD CE02 CONDUCTED EMISSIONS,	
	30 Hz TO 20 kHz, CONTROL AND SIGNAL LEADS	19
	2.1 Instruments and Accessories Used	19
	2.2 Test Setup	19
	2.3 Control Settings and CRT Calibration	19
	2.4 Calibrating and Marking Display	20
	2.5 Frequency Calibration	23
	2.6 Precautions	23
	2.7 Signal Identification	23

3.	METHOD CE03 CONDUCTED EMISSION, 20 kHz TO 50 MHz, POWER LEADS	24
3.1	Instruments and Accessories Used	24
3.2	Test Setup	24
3.3	Control Settings and CRT Calibration	24
3.4	Calibrating and Marking Display	26
3.5	Frequency Calibration	29
3.6	Precautions	29
3.7	Signal Identification	29
4.	METHOD CE04 CONDUCTED EMISSION, 20 kHz TO 50 MHz, CONTROL AND SIGNAL LEADS ...	30
4.1	Instruments and Accessories Used	30
4.2	Test Setup	30
4.3	Control Settings and CRT Calibration.....	30
4.4	Calibrating and Marking Display	32
4.5	Frequency Calibration	35
4.6	Precautions	35
4.7	Signal Identification	35
5.	METHOD CE06 CONDUCTED EMISSIONS, 10 kHz TO 12.4 GHz, ANTENNA TERMINAL	36
5.1	Instruments and Accessories Used	36
5.2	Test Setup	36
5.3	Control Settings and CRT Calibration	37
5.4	Calibrating and Marking Display	38
5.5	Frequency Calibration	40
5.6	Precautions	40
5.7	Signal Identification	40
6.	METHOD CS01, CONDUCTED SUSCEPTIBILITY, 30 Hz TO 50 kHz, POWER LEADS	42
6.1	Instruments and Accessories Used	42
6.2	Test Setup	42
6.3	Control Settings and CRT Calibration	42
6.4	Calibrating and Marking Display	43
6.5	Frequency Calibration	44
6.6	Precautions	44
6.7	Signal Identification	44
7.	METHOD CS02, CONDUCTED SUSCEPTIBILITY 50 kHz TO 400 MHz, POWER LEADS.....	45
7.1	Instruments and Accessories Used	45
7.2	Test Setup	45
7.3	Control Settings and CRT Calibration	45
7.4	Calibrating and Marking Display	47
7.5	Frequency Calibration	47
7.6	Precautions	47
7.7	Signal Identification	47
8.	METHOD RE01, RADIATED EMISSION, 30 Hz TO 30 kHz, MAGNETIC FIELD	48
8.1	Instruments and Accessories Used	48
8.2	Test Setup	48
8.3	Control Settings and CRT Calibration	48
8.4	Calibrating and Marking Display	49

8.5	Frequency Calibration	52
8.6	Precautions	52
8.7	Signal Identification	52
9.	METHOD RE02, RADIATED EMISSION, 14 kHz TO 10 GHz, ELECTRIC FIELD	53
9.1	Instruments and Accessories Used	53
9.2	Test Setup	53
9.3	Control Settings and CRT Calibration	54
9.4	Calibrating and Marking Display	57
9.5	Frequency Calibration	63
9.6	Precautions	63
9.7	Signal Identification	63
10.	METHOD RE03, SPURIOUS AND HARMONIC EMISSIONS, 10 kHz TO 40 GHz	65
10.1	Instruments and Accessories Used	65
10.2	Test Setup	66
10.3	Control Settings, Calibration, and Measurement Techniques	66
10.4	Calibrating and Marking Display	68
10.5	Frequency Calibration	68
10.6	Precautions	69
10.7	Signal Identification	69
11.	METHOD RE04, RADIATED EMISSION, 20 Hz TO 50 kHz, MAGNETIC FIELD	70
11.1	Instruments and Accessories Used	70
11.2	Test Setup	70
11.3	Control Settings and CRT Calibration	70
11.4	Calibrating and Marking Display	71
11.5	Frequency Calibration	74
11.6	Precautions	74
11.7	Signal Identification	74
12.	METHOD RE05, RADIATED EMISSION, BROADBAND, 150 kHz TO 1 GHz, VEHICLES AND ENGINE-DRIVEN EQUIPMENT	75
12.1	Instruments and Accessories Used	75
12.2	Test Setup	75
12.3	Control Settings and CRT Calibration	75
12.4	Calibrating and Marking Display	78
12.5	Frequency Calibration	81
12.6	Precautions	81
12.7	Signal Identification	81
13.	METHOD RE06, RADIATED EMISSION, 14 kHz TO 1 GHz, OVERHEAD POWER LINES	82
13.1	Instruments and Accessories Used	82
13.2	Test Setup	82
13.3	Control Settings and CRT Calibration	82
13.4	Calibrating and Marking Display	85
13.5	Frequency Calibration	88
13.6	Precautions	88
13.7	Signal Identification	88

14. METHOD RS01, RADIATED SUSCEPTIBILITY, 30 Hz TO 30 kHz, MAGNETIC FIELD	89
14.1 Instruments and Accessories Used	89
14.2 Test Setup	89
14.3 Control Settings and CRT Calibration.....	89
14.4 Calibrating and Marking Display	90
14.5 Frequency Calibration	93
14.6 Precautions	93
14.7 Signal Identification	93
15. METHOD RS03, RADIATED SUSCEPTIBILITY, 14 kHz TO 10 GHz, ELECTRIC FIELD	94
15.1 Instruments and Accessories Used	94
15.2 Test Setup	95
15.3 Control Settings and CRT Calibration.....	95
15.4 Calibrating and Marking Display and Measurement Procedure	96
15.5 Frequency Calibration	96
15.6 Precautions	96
15.7 Signal Identification	96
16. METHOD RS04, RADIATED SUSCEPTIBILITY, 14 kHz TO 30 MHz	97
16.1 Instruments and Accessories Used	97
16.2 Test Setup	97
16.3 Control Settings and CRT Calibration.....	97
16.4 Calibrating and Marking Display and Measurement Procedure	98
16.5 Frequency Calibration	98
16.6 Precautions	98
16.7 Signal Identification	98
APPENDIX A – MEASUREMENT OF IMPULSE BANDWIDTH	99
NOMENCLATURE	100
DEFINITION OF IMPULSE BANDWIDTH.....	101
MEASUREMENT OF IMPULSE BANDWIDTH	101
USE OF PIN MODULATOR TO GENERATOR SIGNAL OF KNOWN SPECTRAL PURITY	101
VOLTMETER TRANSIENT	104
APPENDIX B – MAXIMUM BROADBAND SIGNAL LIMITATIONS	105
MAXIMUM BROADBAND SIGNAL THAT CAN BE MEASURED WITHOUT FRONT END OVERLOAD	106
FRONT END OVERLOAD BY IMPULSE CALIBRATOR	107
APPENDIX C – LIST OF SPECTRUM ANALYZER SENSITIVITIES	109
TABLES OF CW SENSITIVITIES.....	110

I INTRODUCTION

BACKGROUND

As the importance of EMC has increased over the years, new standards and procedures have been instituted to work toward the goal of true electromagnetic compatibility in all equipment. Fast, accurate measurements to meet existing standards are a must for the EMC engineer.

The purpose of this note is to describe the measurement procedures used with the HP 8550 series of plug-in spectrum analyzers in order to measure the parameters specified in MIL-STD-461, 462.

BENEFITS

1. The spectrum analyzer reduces the time required to scan a given frequency range and to reduce the resultant data to a useful format.
2. By viewing large portions of the spectrum at a time, individual interference components are not likely to be missed. Intermittent signals are much more likely to be observed.
3. The spectrum analyzer is readily used for "quick checks" during design stages; it helps the EMC engineer work for designed-in compatibility.

HOW TO USE THIS APPLICATION NOTE

Procedures will be given for each method in MIL-STD-461, 462 which requires a calibrated receiver. These procedures will include test setups, control settings, calibration procedures, information on signal interpretation, spurious response detection, front end overload, and recording techniques.

Although the examples given are for MIL-STD-461, 462, most of the procedures are general in nature and may be used in conjunction with other MIL-STD or other EMI specifications. The test methods to be described are:

CE01	Conducted Emission, 30 Hz to 20 kHz, Power Leads
CE02	Conducted Emission, 30 Hz to 20 kHz, Control and Signal Leads
CE03	Conducted Emission, 20 kHz to 50 MHz, Power Leads
CE04	Conducted Emission, 20 kHz to 50 MHz, Control and Signal Leads
CE06	Conducted Emission, 10 kHz to 12.4 GHz, Antenna Terminal
CS01	Conducted Susceptibility, 20 Hz to 50 kHz, Power Lead
CS02	Conducted Susceptibility, 50 kHz to 400 MHz, Power Lead
RE01	Radiated Emission, 30 Hz to 30 kHz, Magnetic Field
RE02	Radiated Emission, 14 kHz to 10 GHz, Electric Field
RE03	Spurious and Harmonic Emissions, 10 kHz to 40 GHz
RE04	Radiated Emission, 20 Hz to 50 kHz, Magnetic Field
RE05	Radiated Emission, Broadband, 150 kHz to 1 GHz, Vehicles and Engine-Driven Equipment
RE06	Radiated Emission, 14 kHz to 1 GHz, Overhead Power Lines

RS01	Radiated Susceptibility, 30 Hz to 30 kHz, Magnetic Field
RS03	Radiated Susceptibility, 14 kHz to 10 GHz, Electric Field
RS04	Radiated Susceptibility, 14 kHz to 30 MHz

Organization within each method is essentially the same and can be outlined as follows:

- X.1 Instruments and Accessories Used
- X.2 Test Setup
- X.3 Control Setting and CRT Calibration
- X.4 Calibrating and Marking Display
- X.5 Frequency Calibration
- X.6 Precautions
- X.7 Signal Identification

Each measurement generally consists of calibrating the analyzer, connecting the signal pickup device, and observing the resultant spectrum display. In cases where extra steps are involved, a measurement procedure is included in Section X.4. Whenever a different procedure is used for different frequency ranges within a method, each procedure is presented in its entirety.

The specification limits and details of a given method are subject to change as the applicable standards are changed. However, the methods presented here should allow you to make any changes with a minimum of difficulty.

NOTE: There are several cases where either the 8554L (500 kHz to 1250 MHz) Tuning Section or the 8555A (10 MHz to 40 GHz) Tuning Section may be used below 1 GHz. Wherever one unit is suggested, the other may be substituted in this range.

All calibrations assume essentially zero loss in the interconnecting cables. When this is not the case, cable losses should be taken into account.

II CALIBRATION OF MEASUREMENT EQUIPMENT

CALIBRATING THE SPECTRUM ANALYZER FOR $\text{dB}\mu\text{V}$

The HP spectrum analyzers are calibrated to read signal level directly in dBm (decibels referred to one milliwatt). In order to measure signal levels in $\text{dB}\mu\text{V}$ (decibels referred to one microvolt) it is only necessary to add 107 dB to any dBm reading; i.e., $0 \text{ dBm } (50\Omega) = +107 \text{ dB}\mu\text{V } (50\Omega)$.

Then: $\text{Signal Level } (\text{dB}\mu\text{V}) = \text{Signal Level } (\text{dBm}) + 107 \text{ dB}$

An optional IF section is available which provides measurements directly in $\text{dB}\mu\text{V}$. The 8552A Option H04 or 8552B Option H04 will allow you to measure signal levels in $\text{dB}\mu\text{V}$ with any of the tuning sections. Since this capability simplifies measurements, it should be considered for any spectrum analyzer to be used for EMI measurements. A modification kit is available to add this capability to standard 8552A/B IF Sections.

USING THE BANDWIDTH FACTOR (B) TO CALIBRATE THE DISPLAY FOR BROADBAND IMPULSE SIGNALS

Broadband signals are discussed in detail in the Appendix.

To calibrate the CRT display so that the spectral intensity S of broadband impulse signals can be read directly in dB above $1 \mu\text{V}/\text{MHz}$, subtract Bandwidth Factor B for the appropriate IF bandwidth from the calibrated narrow band scales as follows:

- a. If the analyzer is calibrated in dBm,

$$S \text{ (in dB}\mu\text{V}/\text{MHz)} = V \text{ (in dB}\mu\text{V)} - B \text{ (in dBMHz)}$$

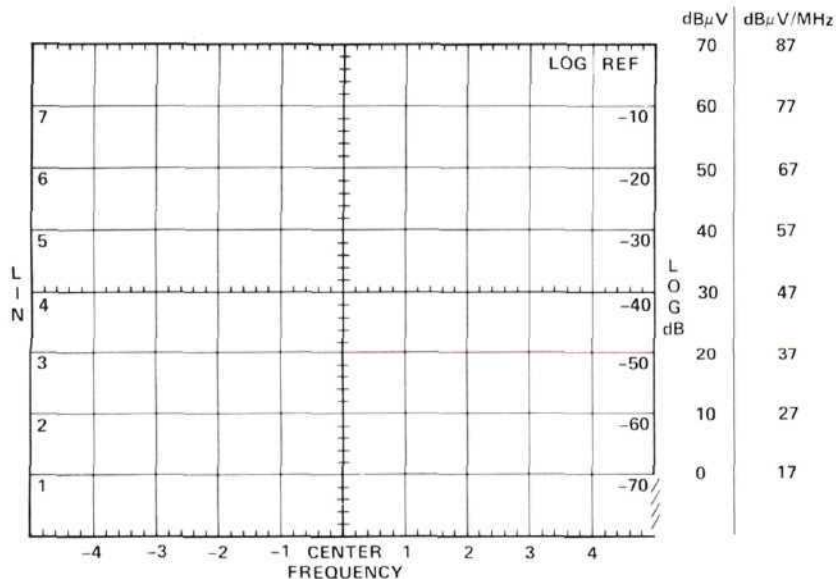

Figure 1. Bandwidth Factor B for this situation is -17 dBMHz (typical for 100 kHz Bandwidth), the conversion is as follows. The level marked $70 \text{ dB}\mu\text{V}$ corresponds to: $70 \text{ dB}\mu\text{V} - (-17 \text{ dBMHz}) = 87 \text{ dB}\mu\text{V}/\text{MHz}$, etc.

b. If the analyzer is calibrated in dBm,

$$S \text{ (in dB}\mu\text{V/MHz)} = V \text{ (in dBm)} - B \text{ (in dBMHz)} + 107 \text{ dB}$$

The procedure for determining the Bandwidth Factor B is given in the next section.

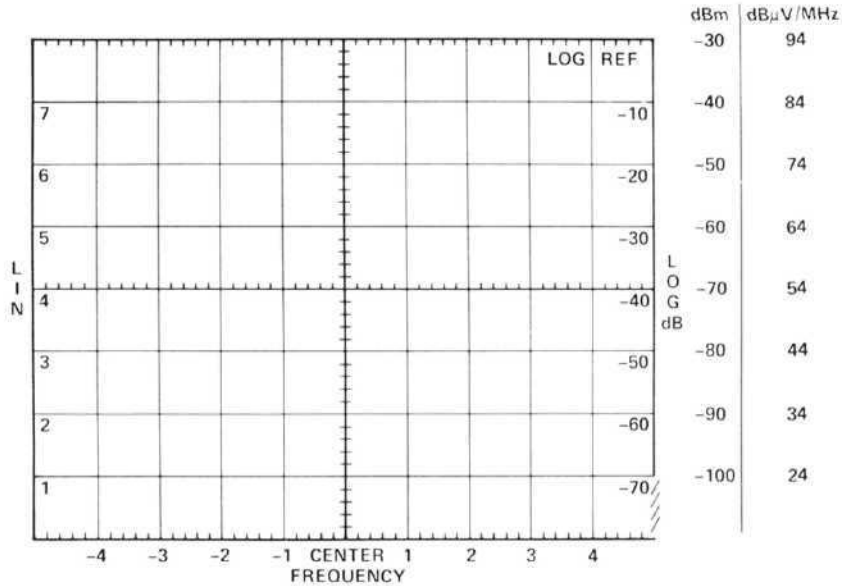

Figure 2. The level marked -30 dBm corresponds to: $-30 \text{ dBm} - (-17 \text{ dBMHz}) + 107 \text{ dB} = 94 \text{ dB}\mu\text{V/MHz}$.

PROCEDURES FOR DETERMINING THE BANDWIDTH FACTOR B (FOR USE WITH THE LOGARITHMIC DISPLAY MODE)

$$\text{Bandwidth Factor B (in dBMHz)} = 20 \log \frac{BWi}{1 \text{ MHz}}$$

where BWi = impulse bandwidth

There are four procedures for determining B which are useful with the spectrum analyzer. Each yields results which agree within 1 dB of the other methods. Each method will be described in some detail. The methods are:

1. Measure the area under the IF response to an impulse and divide by the amplitude.
2. Measure the 6 dB bandwidth.
3. Measure the area of the detector response to an impulse and divide by the amplitude.
4. Measure the response to a known pulse modulated signal.

The last method is the most accurate, but the procedure is the most complicated and can best be performed with the 8554L (500 kHz – 1250 MHz) or 8555A (10 MHz – 40 GHz) Tuning Sections since a microwave test signal is required to get optimum results.

The Bandwidth Factor need only be measured once for each bandwidth with a particular IF section. Changing the tuning section does not affect the Bandwidth Factor.

Method 1

Connect the 30 MHz calibrator to the input of the spectrum analyzer and select the LINEAR display mode. The LINEAR SENSITIVITY should be set to 1 mV/div.

Tune to the 30 MHz signal and set the BANDWIDTH to the desired position. Narrow the SCANWIDTH until the display nearly fills the CRT (See Figure 3). Slow the scan until the DISPLAY UNCAL light goes out.

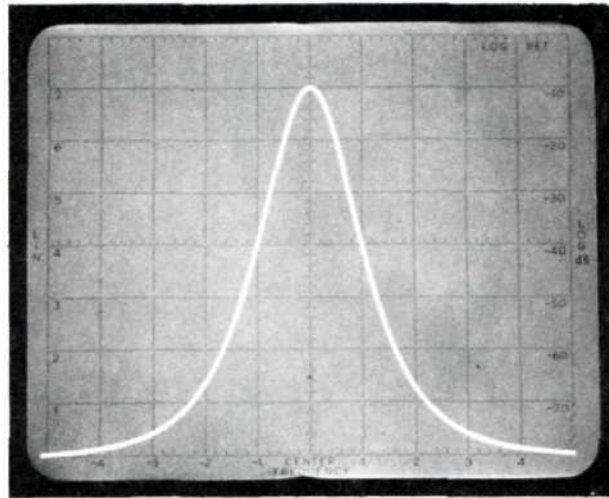

Figure 3. Scan width adjusted to allow measurement of the area under the response curve.

Use the LINEAR SENSITIVITY VERNIER to bring the peak of the display to the top graticule line.

Measure the area under the curve by either photographing the display and using a planimeter or counting the squares under the curve.

$$BW_i \text{ (in kHz)} = \frac{A(k)}{8}$$

where A = area in cm^2

k = SCAN WIDTH PER DIVISION (in kHz)

$$\text{and } B = 20 \log \frac{BW_i}{1 \text{ MHz}}$$

Method 2

Set up the spectrum analyzer as in Method 1 with the 30 MHz calibrator signal displayed in LINEAR and the peak on the top graticule line.

Read the frequency difference between the half voltage points. This is the 6 dB bandwidth which is approximately equal to BW_i . (See Figure 4.)

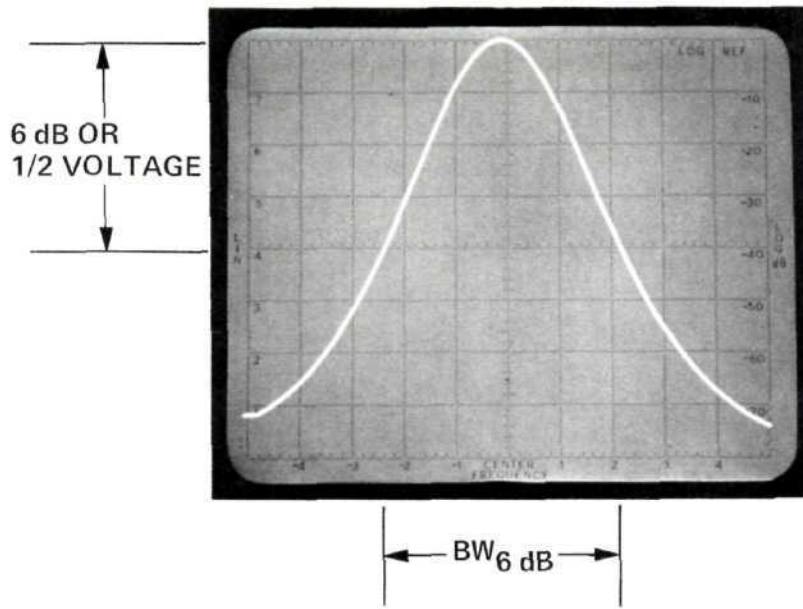

Figure 4. Measurement of 6 dB bandwidth.

Method 3

(This method is described in MIL-STD-826, Method 2003.) Connect an impulse generator to the spectrum analyzer input. (See the Appendix for front end overload considerations.) Tune the spectrum analyzer to a convenient frequency within the bandwidth of the impulse generator.

NOTE: The 8445A Automatic Preselector should always be used with the 8555A (10 MHz – 40 GHz) Tuning Section when making broadband measurements.

Set the spectrum analyzer to ZERO SCAN and set the BANDWIDTH as desired.

Switch to the LINEAR display mode and adjust the LINEAR SENSITIVITY for an on-screen display.

Connect the VERTICAL OUTPUT to an oscilloscope and adjust the oscilloscope controls for a maximum display area in the calibrated portion of the CRT.

Measure the area of the display by either counting squares or integrating with a planimeter. Also measure the amplitude of the display.

$$BW_i \text{ (in Hz)} = \frac{H(s)}{A}$$

where A = area in cm²

H = pattern height in cm

S = sweep rate in cm/sec.

Method 4

The measurement setup is shown in Figure 5. Parts of the following procedure differ according to the bandwidth being measured: the (a) column is used with 10, 30, 100, and 300 kHz IF bandwidth settings; the (b) column with 1 and 3 kHz.

When the average value for BW_i has been determined, calculate B and enter data on a calibration record sheet.

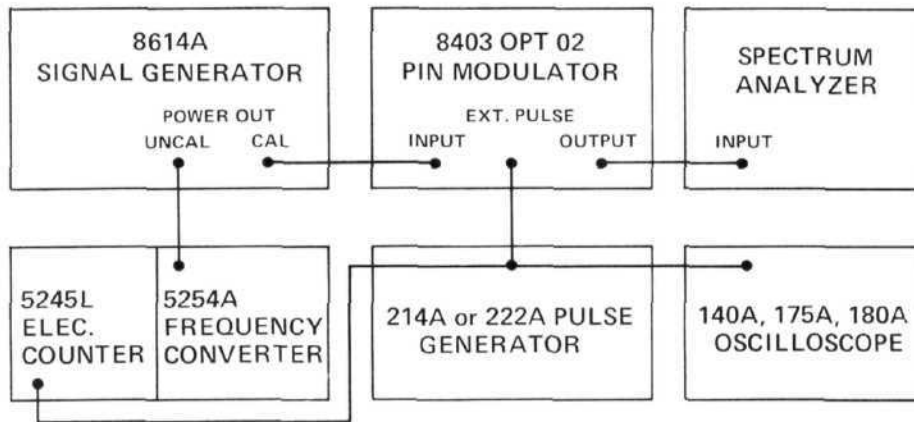

Figure 5. Setup for impulse bandwidth measurement.

The performance of the pin modulator should be checked before making the impulse bandwidth measurement. See Appendix A, Equation (4).

Impulse Bandwidth B can be determined from Equation (14) of the Appendix. This yields:

$$B = 20 \log \frac{BWi}{1 \text{ MHz}} = - [20 \log \frac{V_1}{V_p} + 20 \log \tau + 120] \text{ (dB MHz)}$$

A detailed step-by-step procedure follows in which the term $20 \log \frac{V_1}{V_p}$ is obtained directly as difference of two dB readings of the signal generator attenuator. The pulse width τ is measured for nominal bandwidths of 1 kHz and 3 kHz directly by an oscilloscope that is first calibrated by means of a frequency counter. The pulse width τ is measured indirectly for nominal bandwidths of 10 kHz to 300 kHz by measuring the frequency distance of the main lobe zeros of the displayed spectrum with a frequency counter.

NOTE: The bandwidth settings below 1 kHz are not used for the applications described in this note.

1. Make the following instrument control settings on the spectrum analyzer.

```

FREQUENCY .....1000 MHz
SCAN WIDTH ..... PER DIVISION
TUNING STABILIZER ..... ON
INPUT ATTENUATOR ..... 0 dB
LOG REF LEVEL ..... -40 dBm (70 dBμV)
LOG/LINEAR ..... 10 dB Log
VIDEO FILTER ..... OFF
SCAN MODE ..... INT
SCAN TRIGGER ..... AUTO
(8555A Tuning Section Only)
RANGE ..... 0-2.05 GHz
SIGNAL IDENTIFIER ..... OFF

```

Set the BANDWIDTH control as desired and use the following chart to determine remaining control settings.

Bandwidth selected:	1 kHz	3kHz	10 kHz	30 kHz	100 kHz	300kHz
SCAN WIDTH PER DIVISION	5 kHz	10 kHz	50 kHz	100 kHz	500 kHz	1 MHz
SCAN TIME PER DIVISION	0.2 sec	50 msec	10 msec	10 msec	5 msec	5 msec

10 to 300 kHz IF Bandwidths

- 2a. Set modulator to INTERNAL PULSE; set RATE and WIDTH as specified in Chart 1.
- 3a. Adjust WIDTH control of modulator until the distance between both the zeros adjacent to the main lobe of the displayed spectrum is as specified in Chart 1.
- 4a. Note the exact location of the left zero adjacent to the main lobe of the spectrum on the spectrum analyzer CRT.
- 5a. Set frequency counter to PLUG IN and record frequency as f1.
- 6a. Decrease signal generator FREQUENCY until the right zero adjacent to the main lobe is at the exact location noted in step 4a.
- 7a. Read off frequency as f2.
- 8a. Return signal generator frequency to 1000 MHz.

1 and 3 kHz IF Bandwidth

- 2b. Set modulator to EXTERNAL PULSE.
- 3b. Set pulse generator output to 10V.
- 4b. Set frequency counter to 1 VRMS LEVEL.
- 5b. Adjust RATE of pulse generator until frequency counter reads f3 as specified in Chart 2.
- 6b. Note length of one period on oscilloscope CRT.
- 7b. Adjust RATE of pulse generator to value specified in Chart 2.
- 8b. Adjust WIDTH control of pulse generator until width of pulse on oscilloscope CRT is exactly the length obtained in step 6b.

9. Adjust signal generator ATTENUATOR until peak of the main lobe of the spectrum is at exactly the chosen reference height (i.e., 0, -10, -20, -30, -40, etc.) on the spectrum analyzer CRT display.
10. Read signal generator ATTENUATOR as a₁ in dBm.
11. Turn pulse modulation off by switching modulator to EXTERNAL AM.
12. Adjust signal generator ATTENUATOR so that the height of the peak of the now-displayed CW signal is at exactly the reference height used in step 9.

13. Read signal generator ATTENUATOR as a_p in dBm.

14a. Calculate impulse bandwidth: 14b. Calculate impulse bandwidth:

$$BW_i = \frac{f_1 - f_2}{2 \cdot 10^{(a_1 - a_p)/20}}$$

$$BW_i = \frac{f_3}{10^{(a_1 - a_p)/20}}$$

15. Calculate Bandwidth Figure B:

$$B = 20 \log \frac{BW_i}{1 \text{ MHz}}$$

or

15a. $B = a_p - a_1 + 20 \log \frac{f_1 - f_2}{2 \text{ MHz}}$

15b. $B = a_p - a_1 + 20 \log \frac{f_3}{1 \text{ MHz}}$

Bandwidth Selected	10 kHz	30 kHz	100 kHz	300 kHz
Modulation Rate	2.5 kHz	7.5 kHz	25 kHz	75 kHz
Modulation Width	10 μ sec	3.3 μ sec	1 μ sec	0.33 μ sec
Null Separation	200 kHz	600 kHz	2 MHz	6 MHz

Chart 1. Modulator Settings for Bandwidths from 10 kHz to 300 kHz.

Bandwidth Selected	3 kHz	1 kHz
f_3	30 kHz	10 kHz
Modulation Rate	800 Hz	250 Hz

Chart 2. Modulator Settings for 1 kHz and 3 kHz Bandwidths.

III LABELING AND MARKING THE DISPLAY GRATICULE FOR PHOTOGRAPHY

Marking the horizontal frequency axis and the vertical amplitude axis with numbers is a convenient way to record the spectrum information of the display in a photograph. Specification limits of the MIL-STD being used can also be marked directly on the display. Special pencils such as Stabilo-Swan No. 8008, TAG-Richard Best No. 264, or Pentel Sign Pen can be used for this purpose. Remove any filters from the CRT to reduce parallax problems.

Because the display graticule is on the inner surface of the tube face, parallax must be considered when marking the outer surface and when photographing the display. HP Oscilloscope Cameras 196A and 197A use an ultraviolet light to illuminate the background of the display. Because of the location of this light, marked lines will cast a shadow on the phosphor surface of the display; this shadow is always above the marked line. When using a 197A camera, the shadow line appears much lighter than the real line, but this is not so with a 196A camera. With the 196A, broken lines should be used for marking (you can break a solid line easily with a pointed eraser). The shadow of the broken line will be distinguished from the original marks because it will show as a solid line in the photograph. Figure 6 illustrates the two types of photographs.

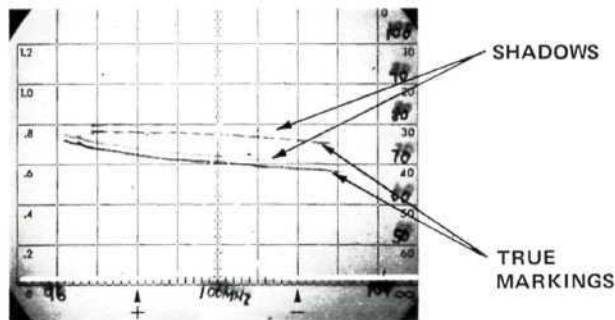

PICTURE TAKEN WITH OSCILLOSCOPE CAMERA 197A

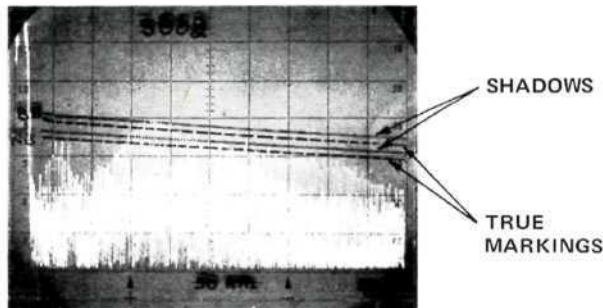

PICTURE TAKEN WITH OSCILLOSCOPE CAMERA 196A

Figure 6. Photographs of Oscilloscope Display

1.3 Control Settings and CRT Calibration

Narrowband Interference

Measurement Number	Frequency Range		Band-width	Scan Width (0-10f mode)	Input Level	Log Ref Level
	fmin	fmax				
1	*20 Hz	200 Hz	10 Hz	20 Hz/Div	-10 dBV	120 dBμV
2	200 Hz	2 kHz	30 Hz	200 Hz/Div	-10 dBV	120 dBμV
3	2 kHz	20 kHz	300 Hz	2 kHz/Div	-10 dBV	120 dBμV

*Measure only from 30 Hz

Broadband Interference

Scan Width (0-10f mode) 2 kHz/Div
 Bandwidth 10 kHz*
 Input Level -10 dBV
 Log Ref Level 120 dBμV

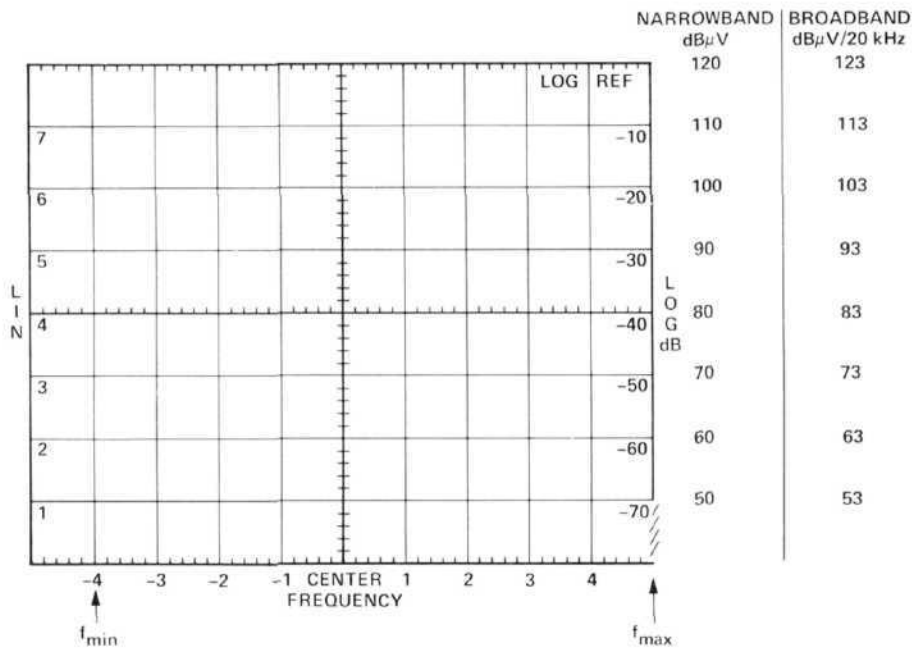

Figure 1B.

*a correction factor will be added to the measured value to obtain the broadband noise in a 20 kHz impulse bandwidth as required by Method CE01. This factor is approximately 3 dB. It may be calculated from the formula:

$$F = |20 \log \frac{BWi}{20 \text{ kHz}}|$$

Where F = correction factor

BWi = Impulse bandwidth when the 10 kHz bandwidth is used.

1.4 Calibrating and Marking Display

Frequency	MIL-STD-461 Limits		Example Only Current Probe Transfer Impedance (dBΩ)	Spectrum Analyzer Input Signal = Spec Limit + Transfer Impedance	
	Narrowband (dBμA)	Broadband (dBμA/20 kHz)		Narrowband (dBμV)	Broadband (dBμV/20 kHz)
30 Hz	120	↑ 90 ↓	0	120	↑ 90 ↓
100 Hz	120		0	120	
200 Hz	120		0	120	
400 Hz	120		0	120	
1 kHz	103		0	103	
10 kHz	62		0	62	
20 kHz	50		0	50	

↓ add to get ↑
 ↓ add to get ↑

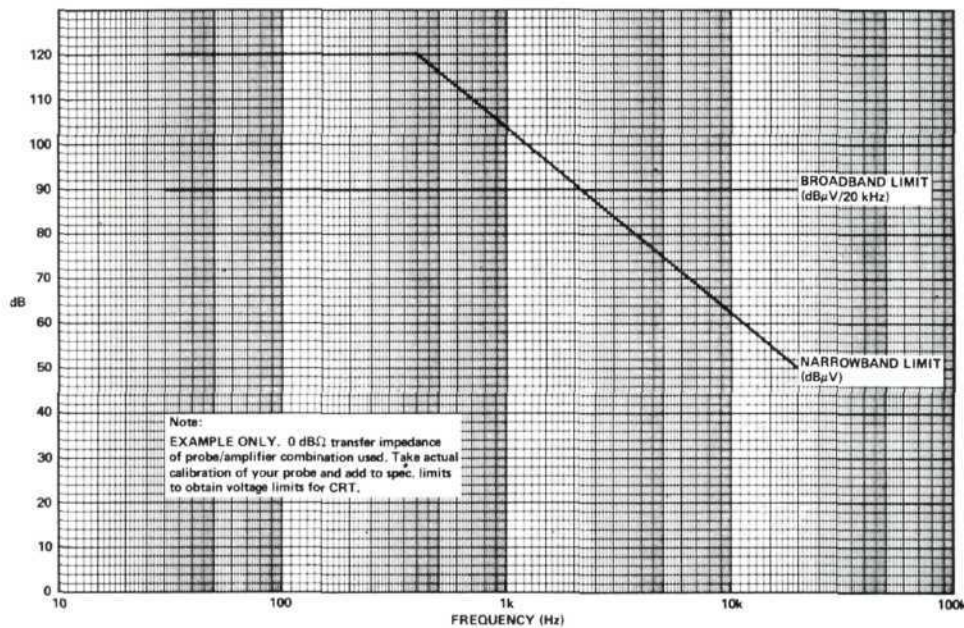

Figure 1C.

Add transfer impedance in dBΩ* of your current probe to MIL-STD specification limits in dBμA (narrowband) and in dBμA/20 kHz (broadband) to obtain spectrum analyzer input signals in dBμV (narrowband) and dBμV/20 kHz (broadband). See tables and curves above.

Copy values onto the spectrum analyzer display. (See following examples.)

*dBΩ = dB above 1Ω, i.e., 10Ω = 20 dBΩ

EXAMPLES

Measurement 1 (Narrowband)

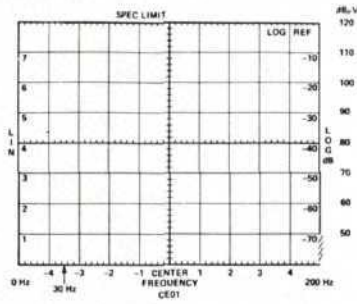

Figure 1D.

CRT calibration is obtained from control settings in Section 1.3. Specification limit is copied from the preceding figure.

Measurement 2 (Narrowband)

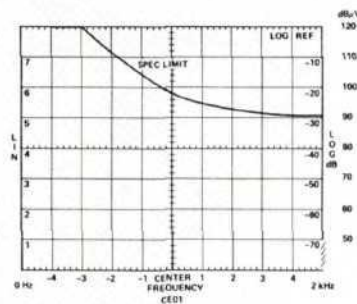

Figure 1E.

Measurement 3 (Narrowband)

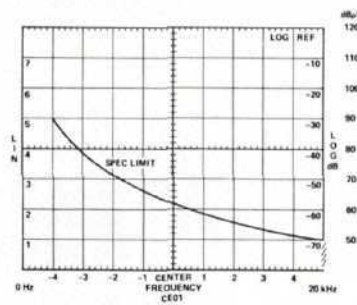
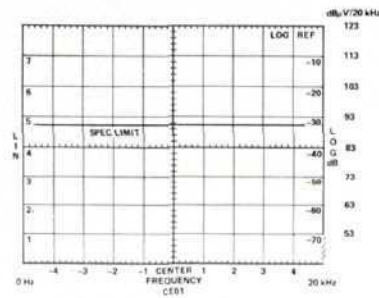

Figure 1F.

Broadband Measurement



(Example, correction factor = 3 dB)

Figure 1G.

NOTE: The exact labeling of the broadband scale depends on the actual bandwidth of your analyzer. See Section 1.3.

Mark frequencies, specification limits, and method number directly on CRT face or use overlay. A photo of the spectrum will then contain all information.

1.5 Frequency Calibration

Set all controls as shown in Step 1.3. With no input to the spectrum analyzer, adjust the ZERO ADJ to bring the LO feedthrough signal to the left edge of the CRT.

1.6 Precautions

Before connecting the input signal, insert the step attenuator between the current probe and the spectrum analyzer. Set the analyzer to scan from 0 — 200 kHz. Start with the attenuator set to 50 dB and decrease the attenuation in 10 dB steps until 0 dB is reached. If any signals exceed the specification limit before 0 dB attenuation is reached, stop the test at that point. Measure the signal level by taking into account the attenuator setting. This will avoid overload of the input and possible damage to the spectrum analyzer.

1.7 Signal Identification

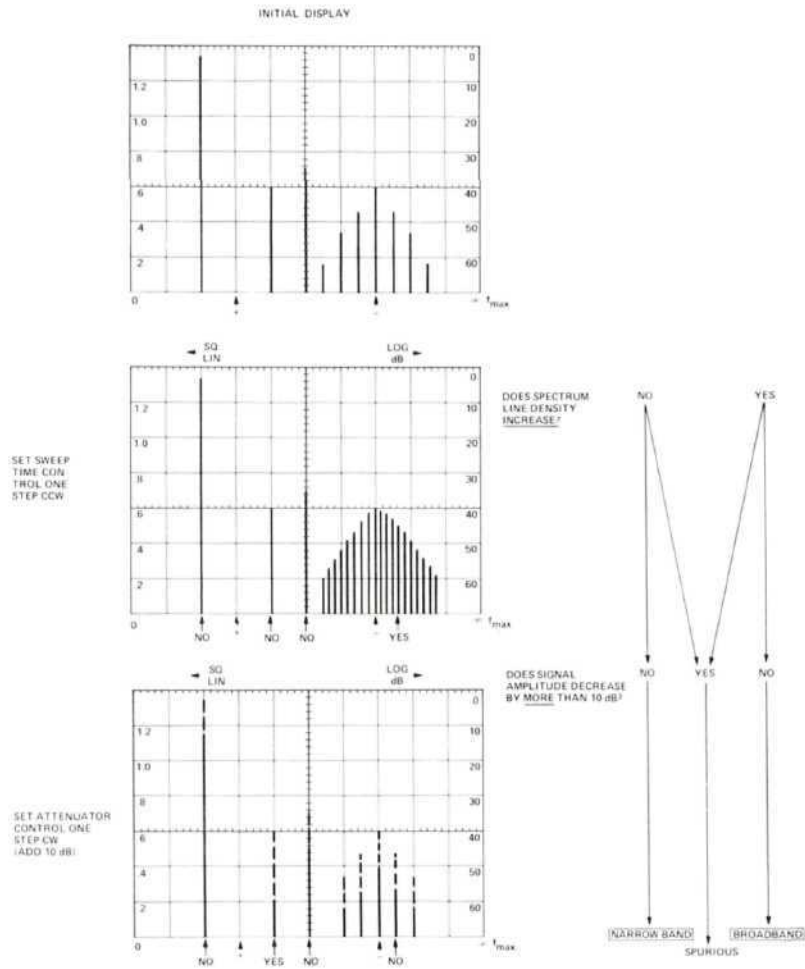

2. METHOD CE02 CONDUCTED EMISSION, 30 Hz TO 20 kHz, CONTROL AND SIGNAL LEADS

The objective of this method is to measure the conducted interference on control and signal leads to the device under test.

2.1 Instruments and Accessories Used

Spectrum Analyzer Tuning Section, Model 8556A Option H11
 Spectrum Analyzer IF Section, Model 8552B Option H04
 Spectrum Analyzer Display Section, Model 141T
 Current Probe, Genistron Model GCP-5120, or equivalent
 Current Probe Amplifier, Genistron Model GF-8470, or equivalent
 Band-Reject Filter (for information bandwidth of device under test)
 Step Attenuator, Model 355D
 Isolation Transformer

2.2 Test Setup

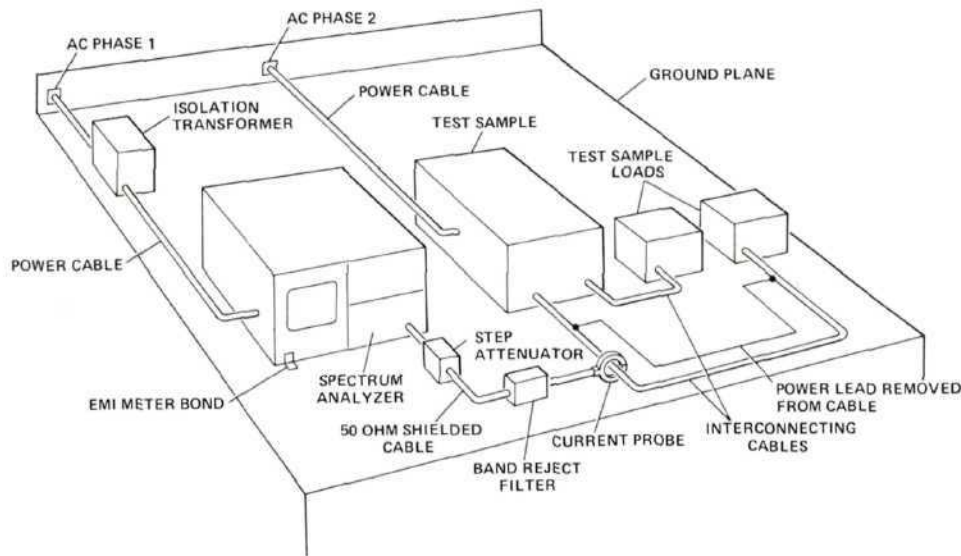

Figure 2A. Typical probe test setup for conducted measurement of interconnecting cables.

2.3 Control Settings and CRT Calibration

Narrowband Interference

Measurement Number	Frequency Range		Band-width	Scan Width (0-10f mode)	Input Level	Log Ref Level
	fmin	fmax				
1	20 Hz*	200 Hz	10 Hz	20 Hz/Div	-10 dBV	120 dB μ V
2	200 Hz	2 kHz	30 Hz	200 Hz/Div	-10 dBV	120 dB μ V
3	2 kHz	20 kHz	300 Hz	2 kHz/Div	-10 dBV	120 dB μ V

*Measure only from 30 Hz

Broadband Interference

Scan Width (0-10f mode) 2 kHz/Div
 Bandwidth 10 kHz*
 Input Level -10 dBV
 Log Ref Level 120 dB μ V

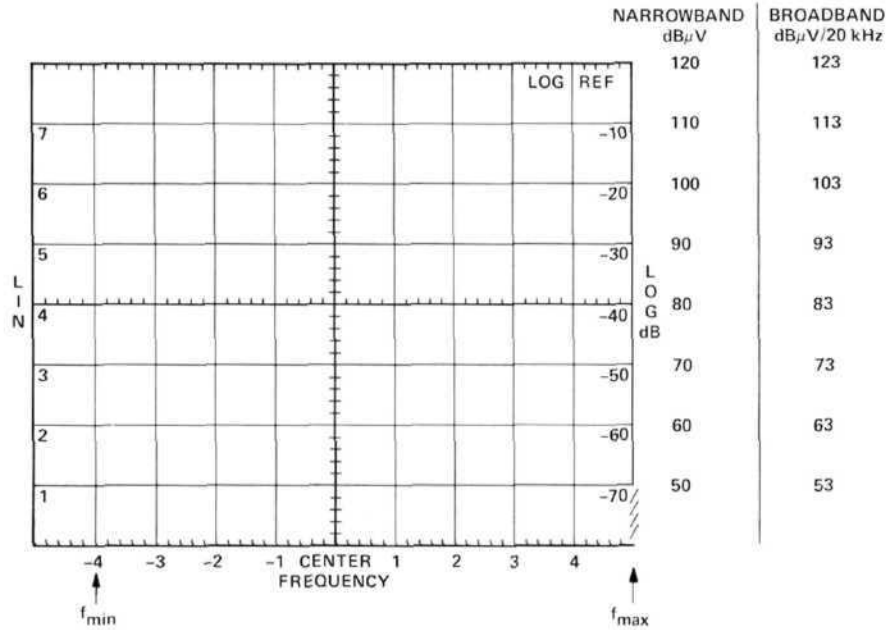

Figure 2B.

2.4 Calibrating and Marking Display

Frequency	MIL-STD-461 Limits		Example Only Current Probe Transfer Impedance (dB Ω)	Spectrum Analyzer Input Signal = Spec Limit + Transfer Impedance	
	Narrowband (dB μ A)	Broadband (dB μ A/20 kHz)		Narrowband (dB μ V)	Broadband (dB μ V/20 kHz)
30 Hz	120	↑	0	120	↑
100 Hz	120		0	120	
200 Hz	120	90	0	120	90
400 Hz	120		0	120	
1 kHz	103	↓	0	103	↓
10 kHz	62		0	62	
20 kHz	50		0	50	
			0		

add to get
 add to get

*A correction factor will be added to the measured value to obtain the broadband noise in a 20 kHz impulse bandwidth as required by method CE02. This factor is approximately 3 dB. It may be calculated from the formula:

$$F = \left[20 \log \frac{BWi}{20 \text{ kHz}} \right]$$

Where F = correction factor in dB

BWi = impulse bandwidth when the 10 kHz bandwidth is used.

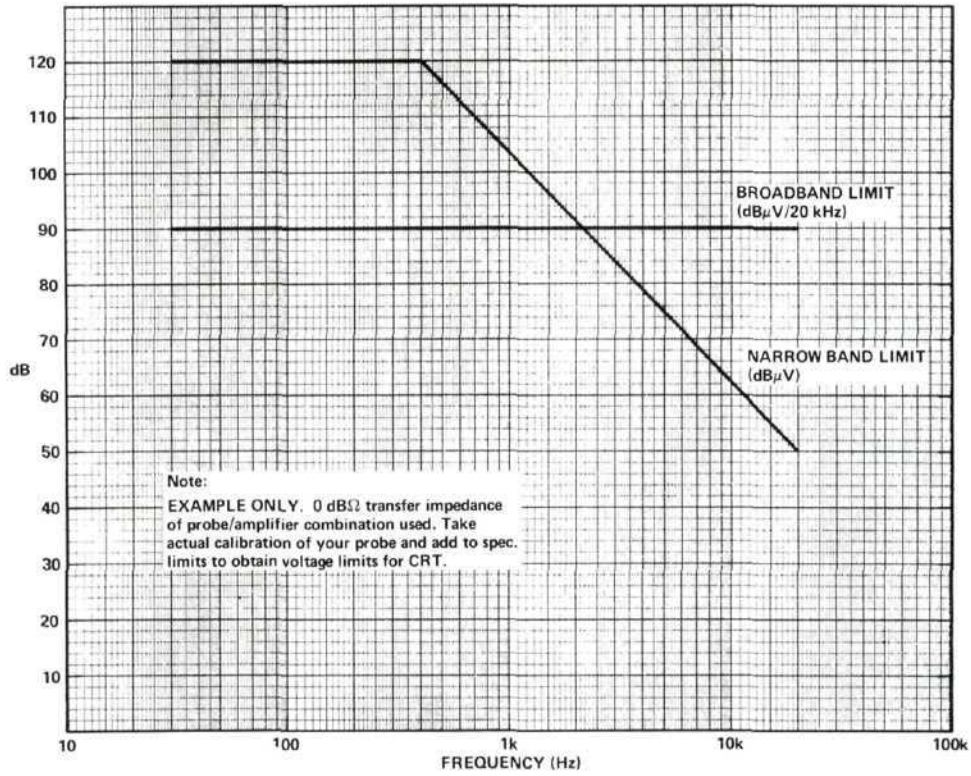

Figure 2C.

Add transfer impedance (in dB Ω) of your current probe to MIL-STD specification limits in dB μ A (narrowband) or dB μ A/20 kHz (broadband) to obtain spectrum analyzer input signals in dB μ V or dB μ V/20 kHz which correspond to the specification limits. See tables and curves above.

Copy values onto the spectrum analyzer display. (See following examples.)

EXAMPLES

Measurement 1 (Narrowband)

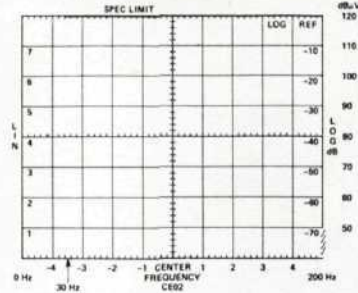

Figure 2D.

CRT calibration is obtained from control settings in Section 2.3. Specification limit is copied from the preceding figure.

Measurement 2 (Narrowband)

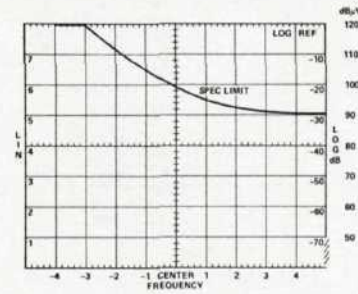

Figure 2E.

Measurement 3 (Narrowband)

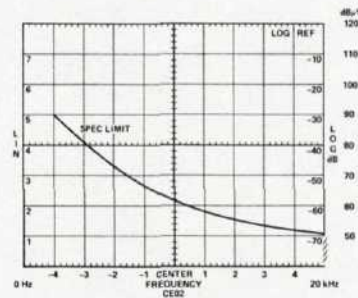

Figure 2F.

Broadband Measurement

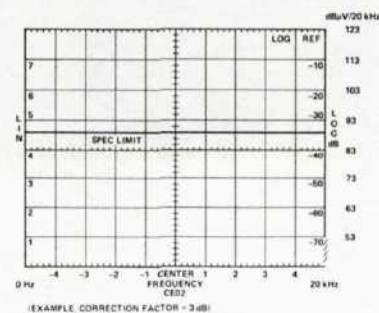

Figure 2G.

NOTE: The exact labeling of the broadband scale depends on the actual bandwidth of your analyzer. See Section 2.3.

Mark frequencies, specification limits, and method number directly on CRT face or use overlay. A photo of the spectrum will then contain all information.

2.5 Frequency Calibration

Set all controls as shown in step 2.3. With no input to the spectrum analyzer, adjust the ZERO ADJ to bring the LO feedthrough signal to the left edge of the CRT.

2.6 Precautions

Before making any measurements, set the step attenuator to 50 dB. Scan the spectrum analyzer from 0 to 200 kHz. Observe the display as the attenuation is decreased in 10 dB steps. If any signal exceeds 120 dB μ V on the display before 0 dB attenuation is reached, stop the test at that point. Measure the signal levels by taking into account the attenuator setting. This will avoid overload of the input and possible erroneous readings.

2.7 Signal Identification

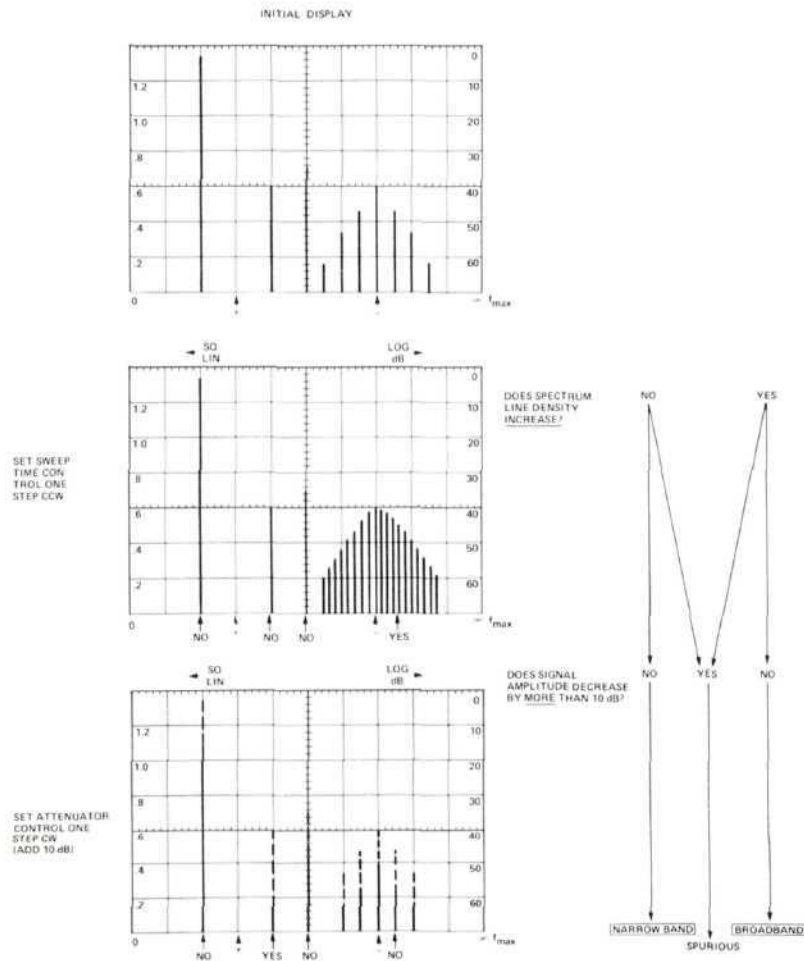

3. METHOD CE03 CONDUCTED EMISSION, 20 kHz TO 50 MHz, POWER LEADS

The objective of this method is to measure interference conducted on the test device power leads over the specified frequency range.

3.1 Instruments and Accessories Used

Spectrum Analyzer Tuning Section, Model 8556A Option H11
Spectrum Analyzer Tuning Section, Model 8553B
Spectrum Analyzer IF Section, Model 8552B, Option H04
Spectrum Analyzer Display Section, Model 141T
Current Probe, Genistron Model GCP-5120, or equivalent
Current Probe, Genistron Model GCP-5130A, or equivalent
Current Probe Amplifier, Genistron Model GF-8470, or equivalent
Ten Microfarad Feedthrough Capacitors
Step Attenuator, Model 355D
Isolation Transformer

3.2 Test Setup

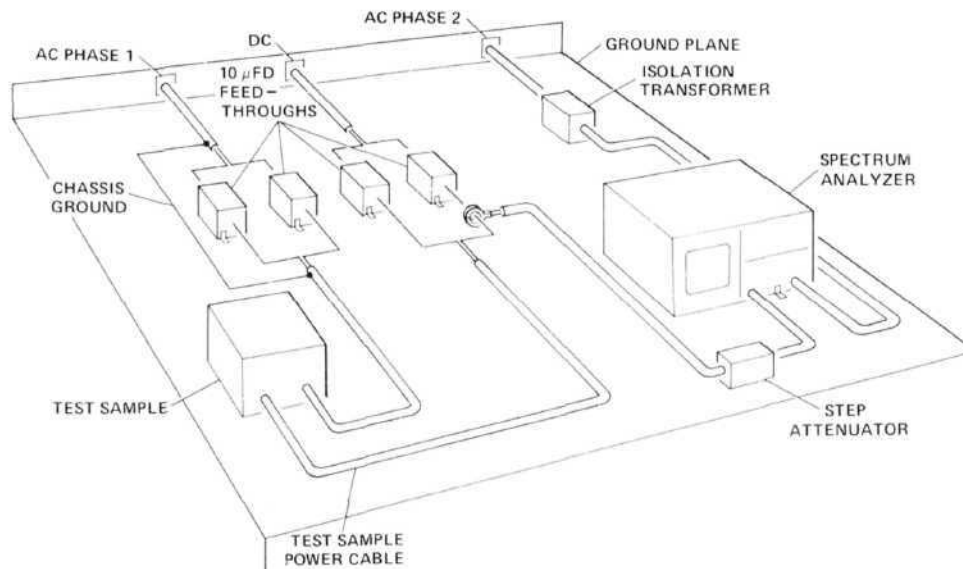

Figure 3A. Typical current probe test setup for conducted emission measurements on power leads.

3.3 Control Settings and CRT Calibration

3.3.1 20 kHz to 200 kHz. For measurements in this range, use the model 8556A Tuning Section and the GCP-5120 Probe.

Narrowband Interference

Frequency Range	$f_{min} = 20 \text{ kHz}/f_{max} = 200 \text{ kHz}$
Bandwidth	300 Hz
Scan Width	20 kHz/div. (0–10f mode)
Input Level	–40 dBV
Log Ref Level.	80 dB μ V

Broadband Interference

Frequency Range $f_{min} = 20 \text{ kHz}/f_{max} = 200 \text{ kHz}$
 Bandwidth 3 kHz
 Scan Width 20 kHz/div. (0–10f mode)
 Input Level -40 dBV
 Log Ref Level 80 dB μ V

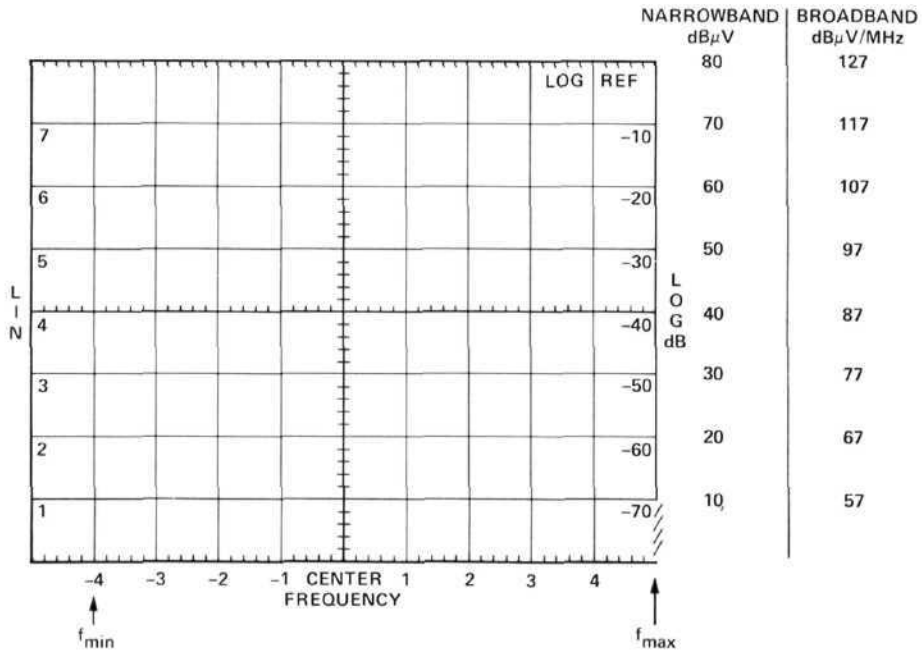

Figure 3B.

3.3.2 200 kHz to 50 MHz. For measurements in this range, use the Model 8553B Tuning Section and the GCP-5130A Probe.

Narrowband Interference

Measurement Number	Frequency Range		Bandwidth	Scan Width	Center Frequency	Log Ref Level
	f_{min}	f_{max}				
1	200 kHz	2 MHz	3 kHz	200 kHz/Div	1 MHz	80 dB μ V
2	5 MHz*	50 MHz	30 kHz	5 MHz/Div	25 MHz	80 dB μ V

Broadband Interference

Measurement Number	Frequency Range		Bandwidth	Scan Width	Center Frequency	Log Ref Level
	f_{min}	f_{max}				
1	200 kHz	2 MHz	30 kHz	200 kHz/Div	1 MHz	80 dB μ V
2	5 MHz*	50 MHz	100 kHz	5 MHz/Div	25 MHz	80 dB μ V

*Measure from 2 MHz

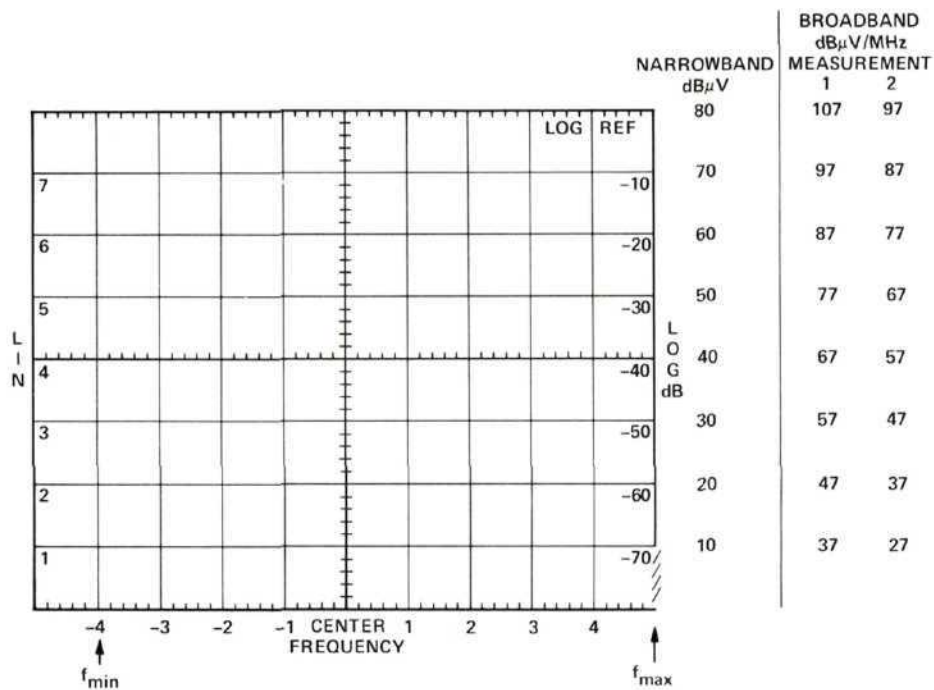

Figure 3C.

3.4 Calibrating and Marking Display

Frequency	MIL-STD-461 Limits		Example Only Current Probe Transfer Impedance (dB Ω)	Spectrum Analyzer Input Signal = Spec Limit + Transfer Impedance	
	Narrowband (dB μ A)	Broadband (dB μ A/MHz)		Narrowband (dB μ V)	Broadband (dB μ V/20 kHz)
20 kHz	50	124	0	50	124
30 kHz	47.5	118	0	47.5	118
50 kHz	44	110	0	44	110
100 kHz	39.5	98	0	39.5	98
150 kHz	37	92	0	37	92
200 kHz	35	87	0	35	87
200 kHz	35	87	8	43	95
300 kHz	32.5	80	10	42.5	90
500 kHz	29	72	14	43	86
1 MHz	24.5	61	14	38.5	75
2 MHz	20	50	14	34	64
10 MHz	20	50	14	34	64
50 MHz	20	50	14	34	64

add to get
 add to get

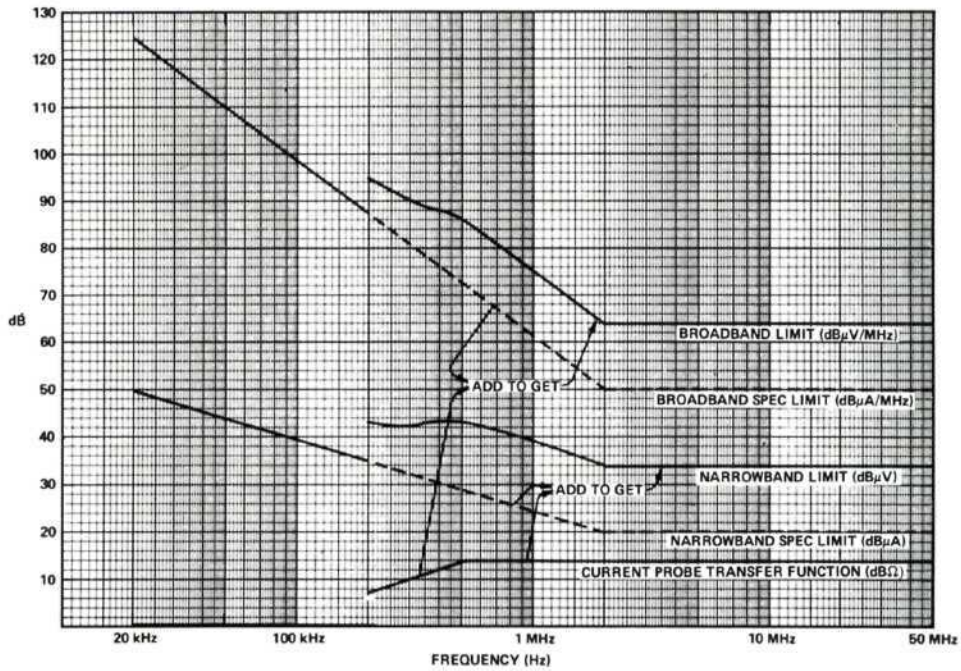

Figure 3D.

Add transfer impedance (in $\text{dB}\Omega$) of your current probe to MIL-STD specification limits in $\text{dB}\mu\text{A}/\text{MHz}$ (broadband) to obtain spectrum analyzer input signals in $\text{dB}\mu\text{V}$ and $\text{dB}\mu\text{V}/\text{MHz}$. See table and curves above.

Then, copy the values obtained onto the spectrum analyzer display. See the following examples.

EXAMPLES

20 kHz to 200 kHz

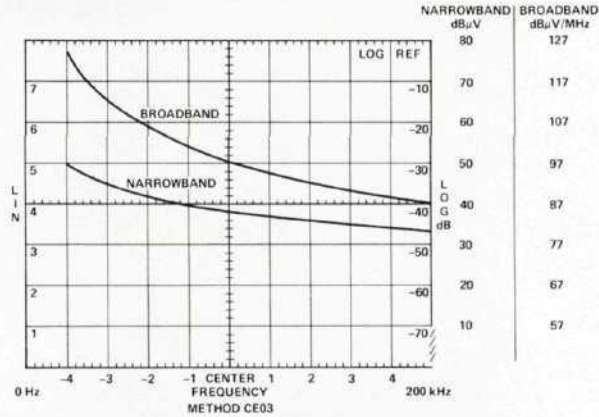

Figure 3E.

Calibration of narrowband signal level due to setting controls as in Section 3.3.1.

Broadband signal level calibration is obtained by subtracting Bandwidth Figure B from the dB μ V calibration.

Example: $+30 \text{ dB}\mu\text{V} = (-47 \text{ dB MHz}) = 77 \text{ dB}\mu\text{V}/\text{MHz}$

200 kHz to 2 MHz

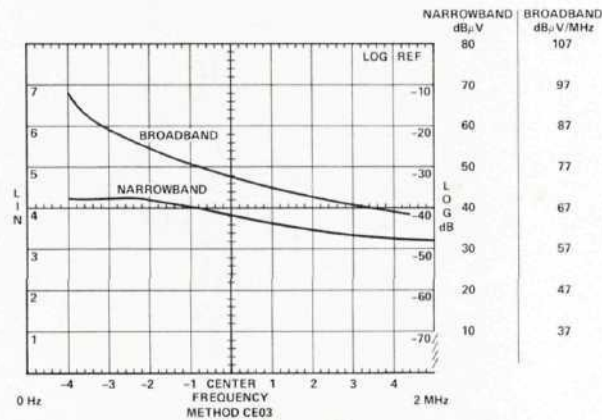

Figure 3F.

NOTE: The exact labeling of the broadband scale depends on the actual bandwidth of your analyzer and should be measured beforehand.

2 MHz to 50 MHz

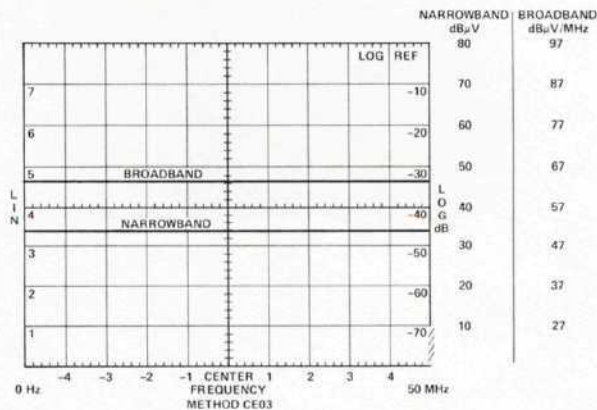

Figure 3G.

Narrowband and broadband limits are copied from table or curves. Label frequency scale as shown in Section 3.3.

Specification limits, frequencies, and method number may be marked directly on CRT or an overlay may be used. A photo of the spectrum will then contain all information.

3.5 Frequency Calibration

Set all controls as shown in step 3.3. For the 20 kHz to 200 kHz range, remove the input to the spectrum analyzer and adjust the ZERO ADJ to bring the L0 feedthrough signal to the left edge of the CRT.

For the 200 kHz to 50 MHz frequency range, use the FREQUENCY control to bring the L0 feedthrough signal to the left edge of the CRT.

3.6 Precautions

Before connecting the input cable, set the step attenuator to 60 dB. Scan the full frequency range (either 0–200 kHz for the low frequency analyzer or 0–100 MHz for the higher frequency analyzer) on the spectrum analyzer. Remove attenuation in 10 dB steps while observing the display. Continue to remove attenuation until some signals do not behave linearly (i.e., they do not go up in 10 dB steps) or until 0 dB is reached. Use the least amount of attenuation which allows linear behavior while making the measurement. (Be sure to account for the attenuator setting in calculating the signal level.)

3.7 Signal Identification

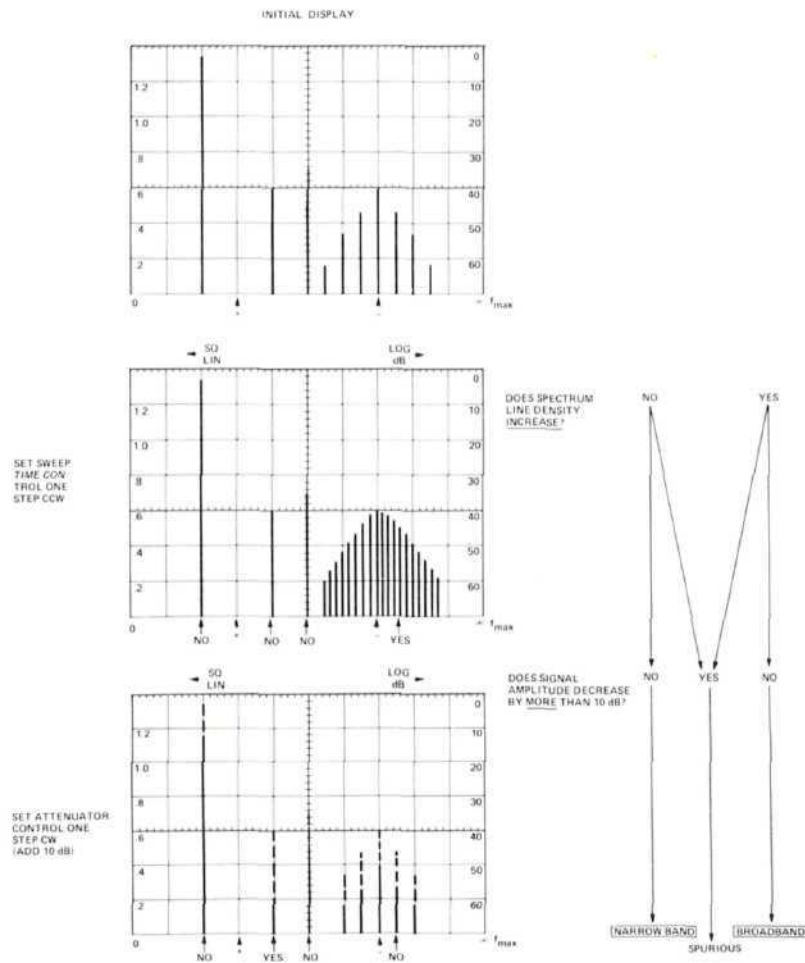

4. METHOD CE04 CONDUCTED EMISSION, 20 kHz TO 50 MHz, CONTROL AND SIGNAL LEADS

The objective of this method is to determine the interference conducted on control and signal leads to the test device over the specified frequency range.

4.1 Instruments and Accessories Used

Spectrum Analyzer Tuning Section, Model 8556A Option H11
Spectrum Analyzer Tuning Section, Model 8553B
Spectrum Analyzer IF Section, Model 8552B Option H04
Spectrum Analyzer Display Section, Model 141T
Current Probe, Genistron Model GCP-5120, or equivalent
Current Probe, Genistron Model GCP-5130A, or equivalent
Current Probe Amplifier, Genistron Model GF-8470, or equivalent
Ten Microfarad Feedthrough Capacitors
Step Attenuator, Model 355D

4.2 Test Setup

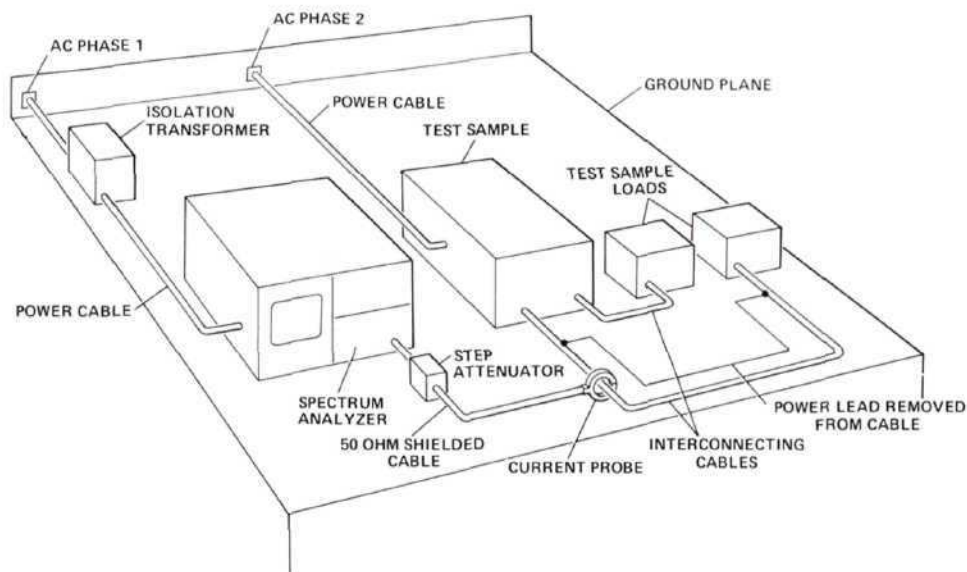

Figure 4A. Typical probe test setup for conducted measurement of interconnecting cables.

4.3 Control Settings and CRT Calibration

4.3.1 20 kHz to 200 kHz. For measurements in this range, use the Model 8556A Tuning Section and the GCP-5120 Probe.

Narrowband Interference

Frequency Range $f_{min} = 20 \text{ kHz}/f_{max} = 200 \text{ kHz}$
Bandwidth 3 kHz
Scan Width 20 kHz/Div (0–10f mode)
Input Level -40 dBV
Log Ref Level 80 dB μ V

Broadband Interference

Frequency Range $f_{min} = 20 \text{ kHz}/f_{max} = 200 \text{ kHz}$
 Bandwidth 300 Hz
 Scan Width 20 kHz/Div (0–10f mode)
 Input Level -40 dBV
 Log Ref Level 80 dB μ V

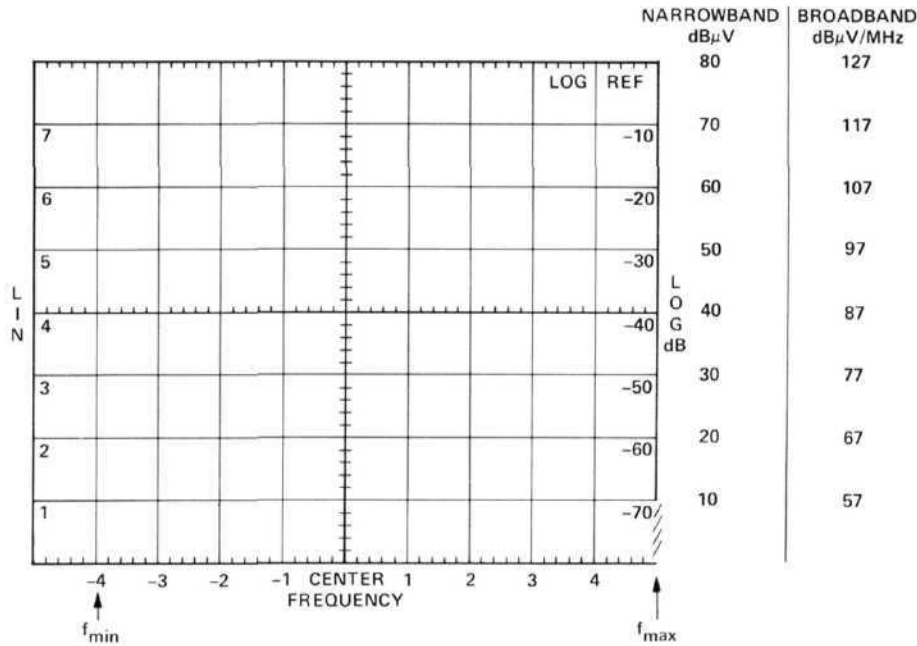

Figure 4B.

4.3.2 200 kHz to 50 MHz. For measurements in this range, use the Model 8553B Tuning Section and the GCP-5130A Probe.

Narrowband Interference

Measurement Number	Frequency Range		Bandwidth	Scan Width	Center Frequency	Log Ref Level
	f_{min}	f_{max}				
1	200 kHz	2 MHz	3 kHz	200 kHz/Div	1 MHz	80 dB μ V
2	5 MHz*	50 MHz	30 kHz	5 MHz/Div	25 MHz	80 dB μ V

Broadband Interference

Measurement Number	Frequency Range		Bandwidth	Scan Width	Center Frequency	Log Ref Level
	f_{min}	f_{max}				
1	200 kHz	2 MHz	30 kHz	200 kHz/Div	1 MHz	80 dB μ V
2	5 MHz*	50 MHz	100 kHz	5 MHz/Div	25 MHz	80 dB μ V

*Measure from 2 MHz

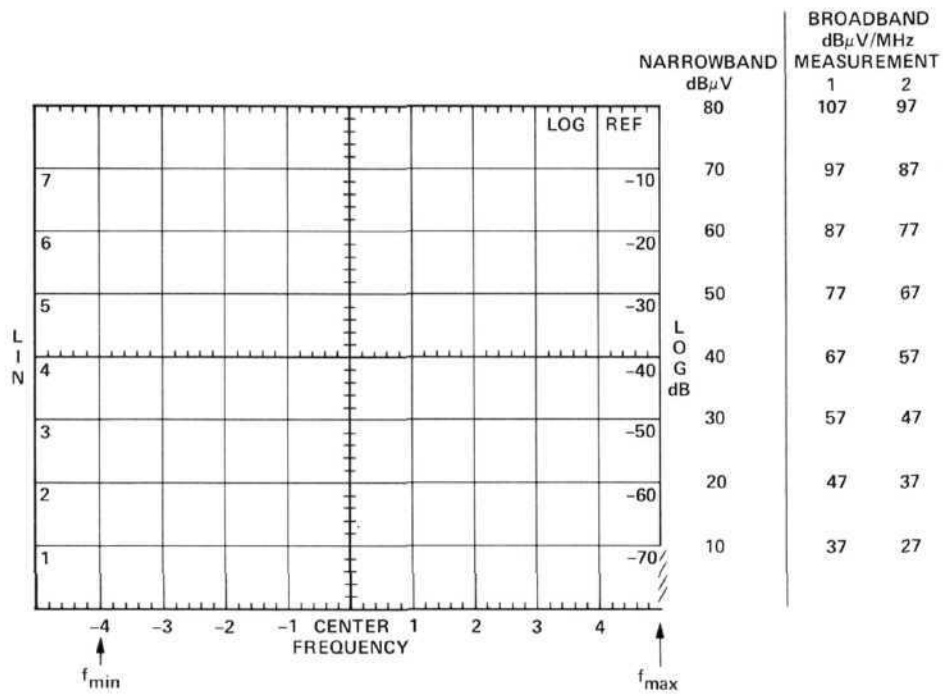

Figure 4C.

4.4 Calibrating and Marking Display

Frequency	MIL-STD-461 Limits		Example Only Current Probe Transfer Impedance (dB Ω)	Spectrum Analyzer Input Signal = Spec Limit + Transfer Impedance	
	Narrowband (dB μ A)	Broadband (dB μ A/MHz)		Narrowband (dB μ V)	Broadband (dB μ V/20 kHz)
20 kHz	50	124	0	50	124
30 kHz	47.5	118	0	47.5	118
50 kHz	44	110	0	44	110
100 kHz	39.5	98	0	39.5	98
150 kHz	37	92	0	37	92
200 kHz	35	87	0	35	87
200 kHz	35	87	8	43	95
300 kHz	32.5	80	10	42.5	90
500 kHz	29	72	14	43	86
1 MHz	24.5	61	14	38.5	75
2 MHz	20	50	14	34	64
10 MHz	20	50	14	34	64
50 MHz	20	50	14	34	64

↑ add to get

↑ add to get

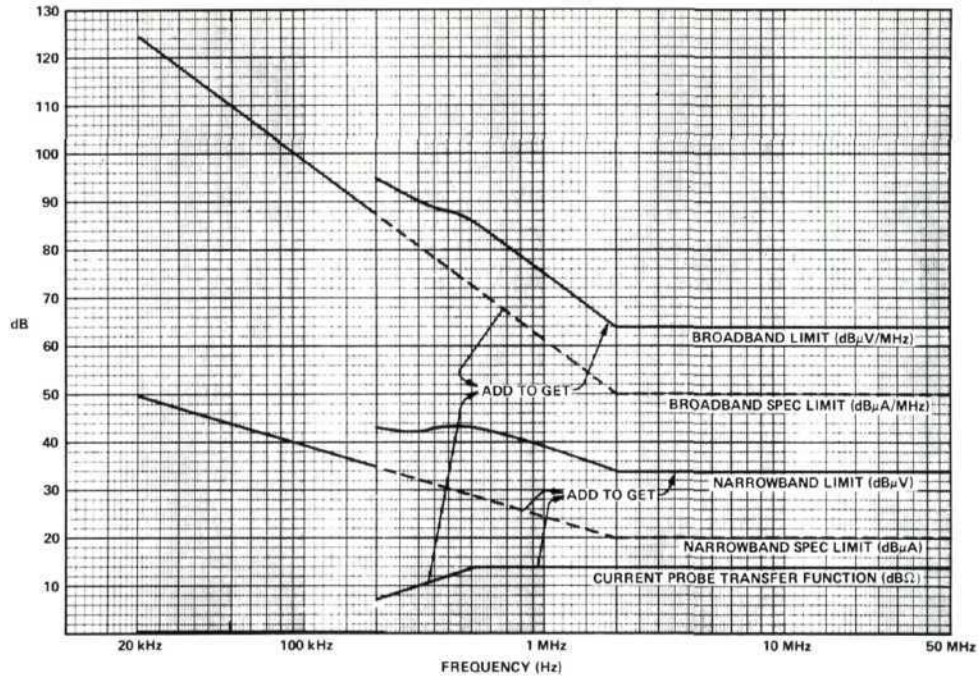

Figure 4D.

Add transfer impedance (in $\text{dB}\Omega$) of your current probe to MIL-STD specification limits in $\text{dB}\mu\text{A}$ (narrowband) and in $\text{dB}\mu\text{A}/\text{MHz}$ (broadband) to obtain spectrum analyzer input signals in $\text{dB}\mu\text{V}$ and $\text{dB}\mu\text{V}/\text{MHz}$. See table and curves above.

Then, copy the values obtained onto the spectrum analyzer display. See the following examples.

EXAMPLES

20 kHz to 200 kHz

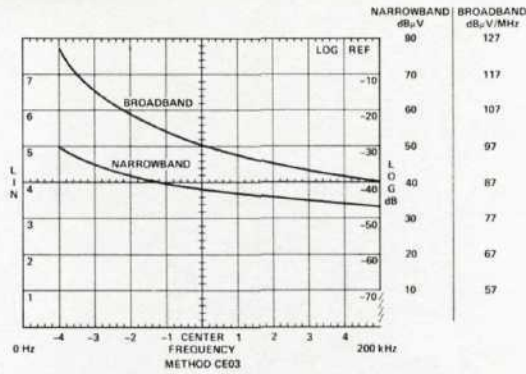

Figure 4E.

Calibration of narrowband signal level due to setting controls as in Section 4.3.1.

Broadband signal level calibration is obtained by subtracting Bandwidth Figure B from the dB μ V calibration.

Example: $+30 \text{ dB}\mu\text{V} - (-47 \text{ dBMHz}) = 77 \text{ dB}\mu\text{V/MHz}$

200 kHz to 2 MHz

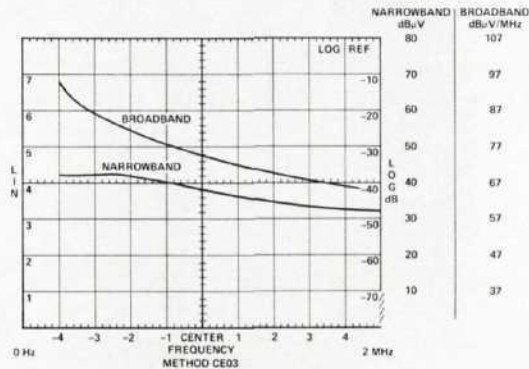

Figure 4F.

NOTE: The exact labeling of the broadband scale depends on the actual bandwidth of your analyzer and should be measured beforehand.

2 MHz to 50 MHz

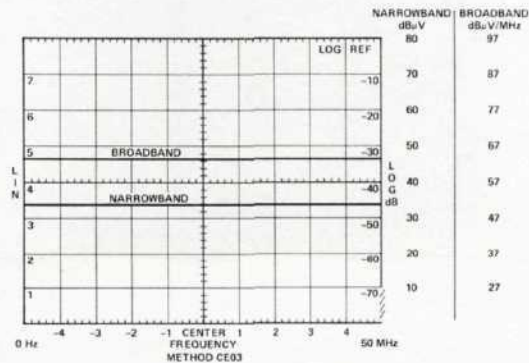

Figure 4G.

Narrowband and broadband limits are copied from table or curves.

Label frequency scale as shown in Section 4.3.

Specification limits, frequencies, and method number may be marked directly on CRT or an overlay may be used. A photo of the spectrum will then contain all information.

4.5 Frequency Calibration

Set all controls as shown in step 4.3. For the 20 kHz to 200 kHz range, remove the input to the spectrum analyzer and adjust the ZERO ADJ to bring the L0 feedthrough signal to the left edge of the CRT.

For the 200 kHz to 50 MHz frequency range, use the FREQUENCY control to bring the L0 feedthrough signal to the left edge of the CRT.

4.6 Precautions

Before making any measurements, set the step attenuator to 60 dB. Scan the full frequency range (either 0–200 kHz for the low frequency analyzer or 0–100 MHz for the higher frequency analyzer) on the spectrum analyzer. Remove attenuation in 10 dB steps while observing the display. Continue to remove attenuation until some signals do not behave linearly (i.e., they do not increase in 10 dB steps) or until 0 dB is reached. Use the least amount of attenuation which allows linear behavior while making the measurement. (Be sure to account for the attenuator setting in calculating the signal level.)

4.7 Signal Identification

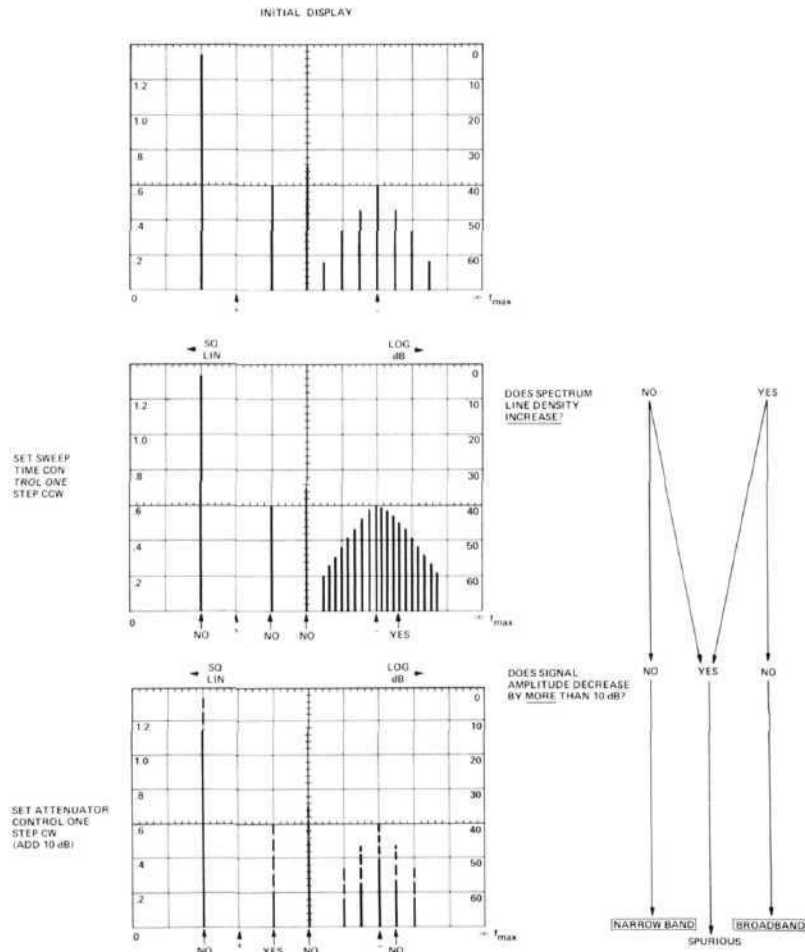

5. METHOD CE06, CONDUCTED EMISSION, 10 kHz TO 12.4 GHz, ANTENNA TERMINAL

The objective of this method is to measure the conducted interference appearing at the antenna terminals on receivers and transmitters in key-up and key-down conditions, RF amplifiers, and other devices intended to be connected to an antenna.

5.1 Instruments and Accessories Used

Spectrum Analyzer Tuning Section, Model 8553B
 Spectrum Analyzer Tuning Section, Model 8555A
 Spectrum Analyzer IF Section, Model 8552B Option H04
 Spectrum Analyzer Display Section, Model 141T
 Automatic Preselector, Model 8445A
 Step Attenuator, Model 354A
 Amplifier, Model 8447A
 Rejection Network for Fundamental Frequency
 Attenuator
 Directional Coupler*
 Dummy Load*

*Dependent on test setup required.

5.2 Test Setup

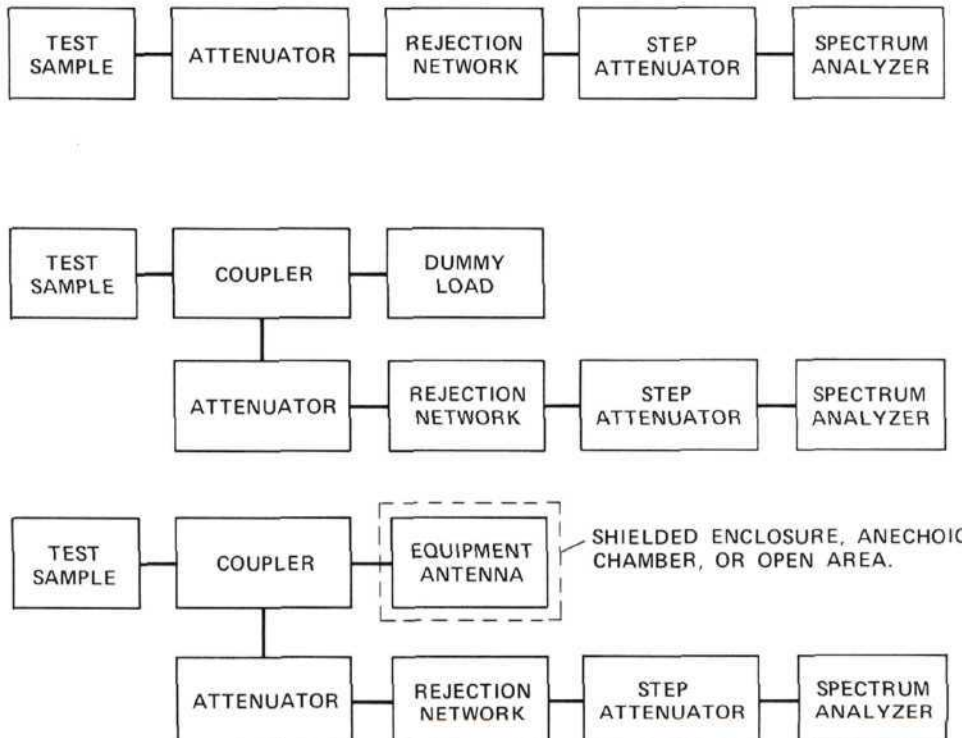

NOTE: AVERAGE POWER TO SPECTRUM ANALYZER AT f_0
 MUST NOT EXCEED -40 dBm.

Figure 5A. Test setups for Method CE06. See MIL-STD 462 for individual requirements. (When the amplifier is used, it will be inserted between the step attenuator and the spectrum analyzer.)

5.3 Control Settings and CRT Calibration

5.3.1 10 kHz to 100 MHz. For measurements in this range, use the Model 8553B Tuning Section and the Model 8447A Amplifier (key-up only).

Measurement Number	Frequency Range		Bandwidth	Scan Width	Center Frequency	Log Ref* Level
	fmin	fmax				
1	10 kHz	100 kHz	10 kHz	10 kHz/Div	50 kHz	80 dB μ V
2	100 kHz	1 MHz	30 kHz	100 kHz/Div	500 kHz	80 dB μ V
3	1 MHz	10 MHz	100 kHz	1 MHz/Div	5 MHz	80 dB μ V
4	10 MHz	100 MHz	100 kHz	10 MHz/Div	50 MHz	80 dB μ V

*In the key-down mode, the Log Ref Level depends on the transmitter under test and the attenuator or coupler used. It should be set about 40 dB higher than the specification limit. As an example, if the output power of the transmitter is +10 dBW and a 30 dB attenuator is used, then -20 dBW will appear at the rejection network. The specification limit is -60 dBW for spurious outputs from the transmitter or -90 dBW at the rejection network (since spurious responses will also be attenuated by the 30 dB attenuator). This amounts to -60 dBm or +47 dB μ V at the spectrum analyzer. Therefore, the Log Ref Level would be set to about 80 dB μ V.

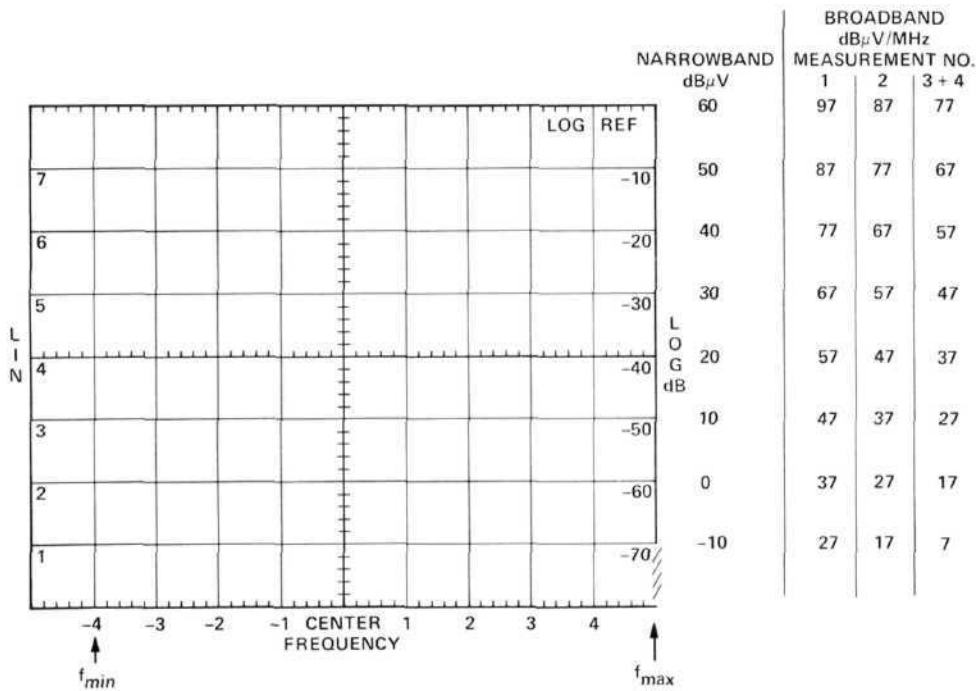

NOTE: THE CRT SCALE ACCOUNTS FOR THE 20 dB GAIN OF THE AMPLIFIER.

Figure 5B.

5.3.2 100 MHz to 12.4 GHz. For measurements in this range, the Model 8555A Tuning Section and 8445A Automatic Preselector should be used.

Measurement Number	Frequency Range		Frequency Band	Bandwidth	Scan Width	Center Frequency	Log Ref*** Level
	fmin	fmax					
1	0 Hz	2 GHz*	0.01–2.05	100 kHz	200 MHz/Div	1 GHz	60 dB μ V
2	1.5 GHz	3.5 GHz**	1.5–3.55	100 kHz	200 MHz/Div	2.5 GHz	60 dB μ V
3	3.5 GHz	4.5 GHz	2.6–4.65	100 kHz	100 MHz/Div	4.0 GHz	60 dB μ V
4	4.5 GHz	6.5 GHz	4.13–10.25	100 kHz	200 MHz/Div	5.5 GHz	60 dB μ V
5	6.5 GHz	8.5 GHz	6.17–10.25	100 kHz	200 MHz/Div	7.5 GHz	60 dB μ V
6	8.5 GHz	10.5 GHz	8.23–14.35	100 kHz	200 MHz/Div	9.5 GHz	60 dB μ V
7	10.5 GHz	12.5 GHz	8.23–14.35	100 kHz	200 MHz/Div	11.5 GHz	60 dB μ V

*Measure from 100 MHz to 1.8 GHz
 **Measure from 1.8 GHz
 ***See note in Section 5.3.1.

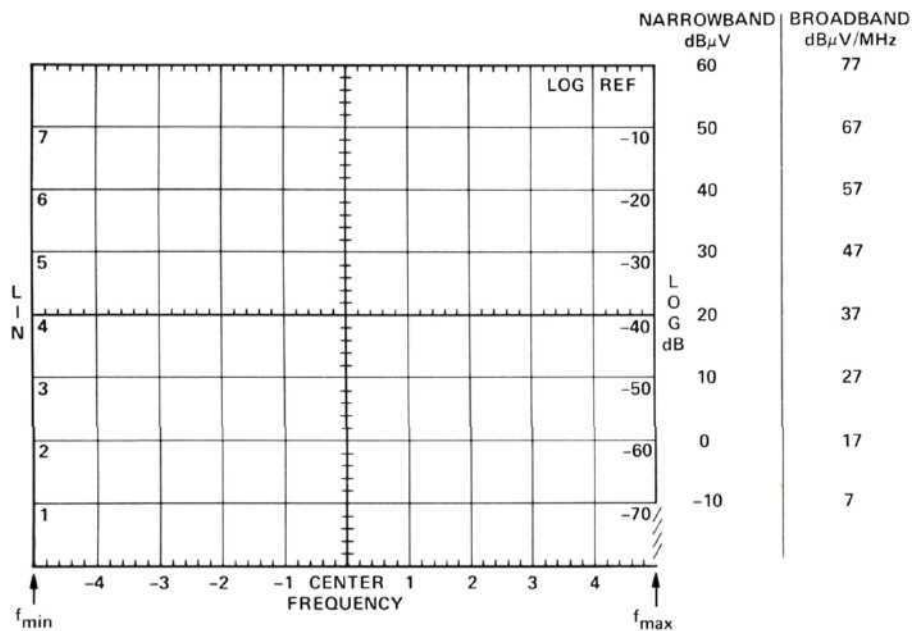

Figure 5C.

5.4 Calibrating and Marking Display

5.4.1 Key-Down Mode. To obtain specification limit for CRT calibration, proceed as follows:

1. Determine the peak output power of the transmitter under test.
2. Read the specification limit from MIL-STD-461A.
3. Subtract the attenuation of attenuator or directional coupler.
4. Add 137 dB to convert to dB μ V from dBW.

Example

1. 30 dBW transmitter to be tested.
2. Specification limit from MIL-STD-461A = -60 dBW
3. 30 dB coupler used gives -90 dBW limit at output.
4. -90 dBW +137 dB = +47 dB μ V limit on spectrum analyzer
 (+90 dB μ V Log Ref Level would then be used to give convenient display.)

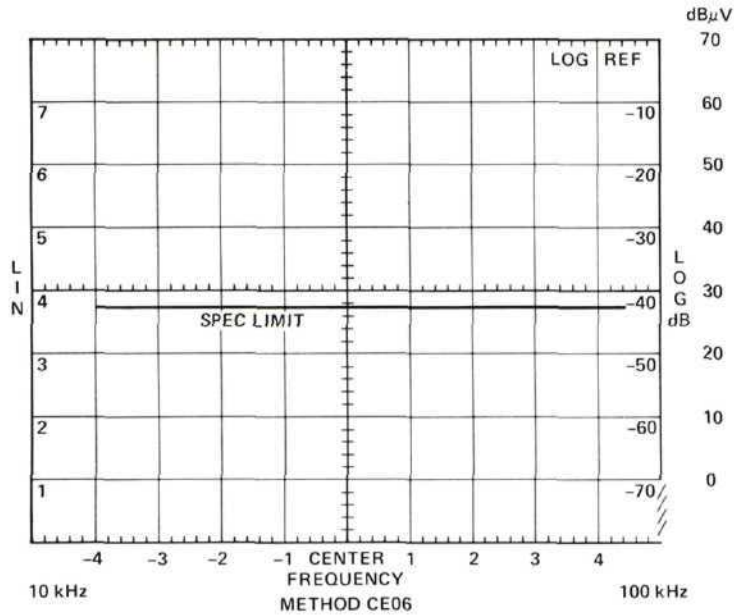

Figure 5D.

All other frequency ranges will be similar.

5.4.2 Key-Up Mode and Receivers. The specification limit is +34 dBμV for narrowband emissions and +40 dBμV/MHz for broadband emissions. Therefore, the limits can be readily marked on the CRT using the scales given in Section 5.3.

For example, Measurement 1 in Section 5.3.1 would yield the scale markings shown below.

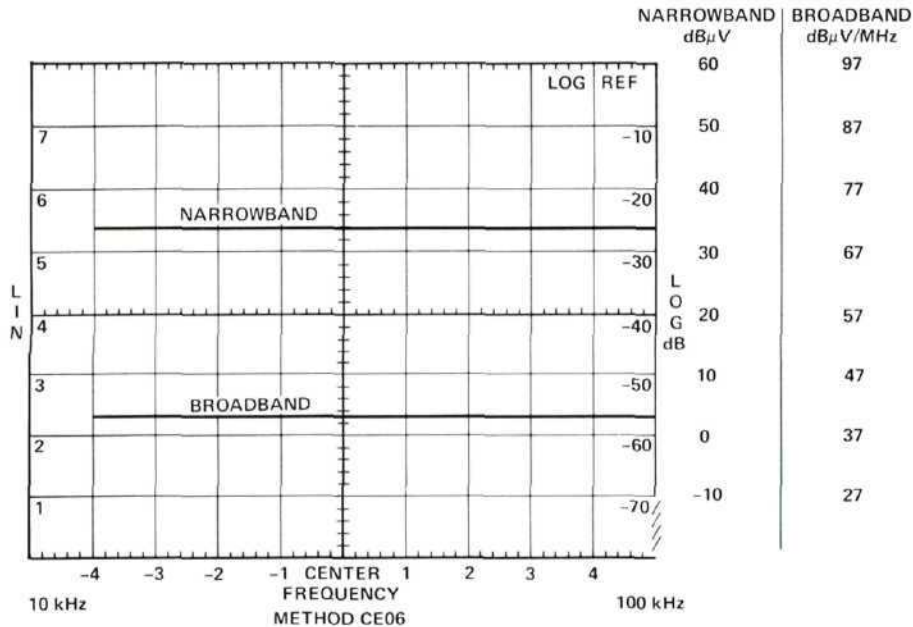

Figure 5E.

Specification limits, frequency, and method number may be marked directly on CRT or an overlay may be used. A photo of the spectrum will then contain all information.

5.5 Frequency Calibration

5.5.1 10 kHz – 100 MHz. Set all controls as shown in Section 5.3.1. Adjust frequency control or Fine Tune to bring the L0 feedthrough signal to the left edge of the CRT.

5.5.2 100 MHz – 12.4 GHz. Set all controls as shown in Section 5.3.2. For measurement 1, adjust the Frequency control to bring the L0 feedthrough signal to the left edge of the CRT. For all other measurements, use the frequency settings given in the chart.

5.6 Precautions

Before making any measurements, set the step attenuator to 60 dB. Use the preset scan mode on the spectrum analyzer (either 0–100 MHz or FULL SCAN, depending on the tuning section in use). Remove attenuation in 10 dB steps while observing the display. Continue to remove attenuation until some signals do not behave linearly (i.e., they do not increase in 10 dB steps) or until 0 dB is reached. Use the least amount of attenuation which allows linear behavior while making the measurement. (Be sure to account for the attenuator setting in calculating the signal level.)

5.7 Signal Identification

5.7.1 10 kHz – 100 MHz

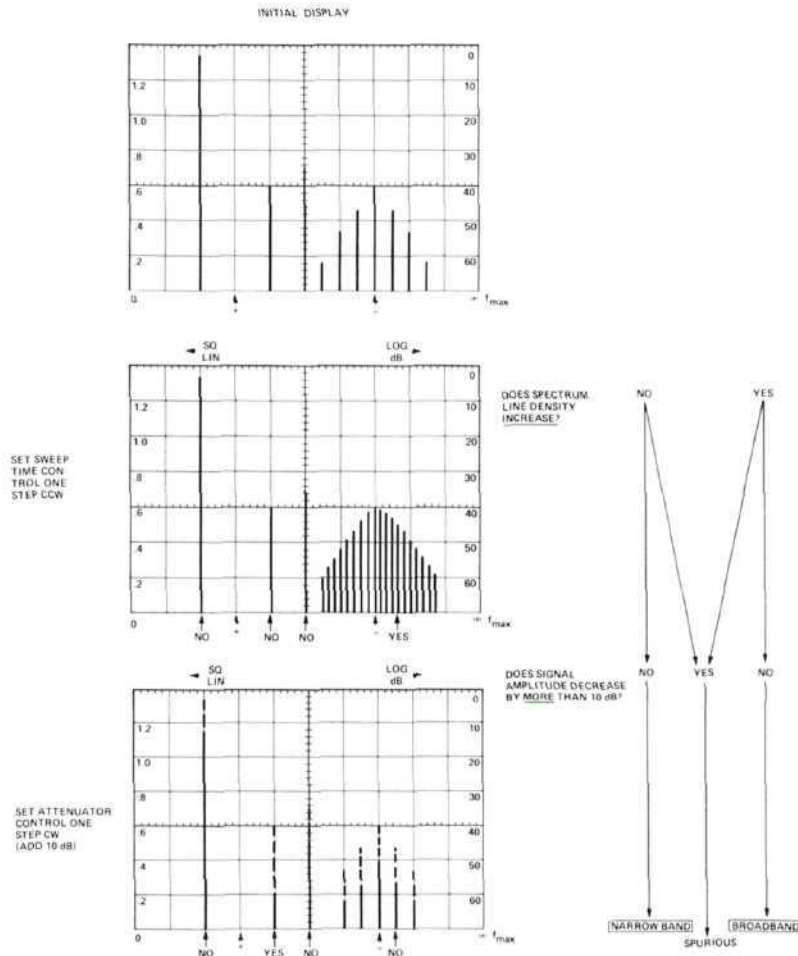

5.7.2 100 MHz – 12.4 GHz

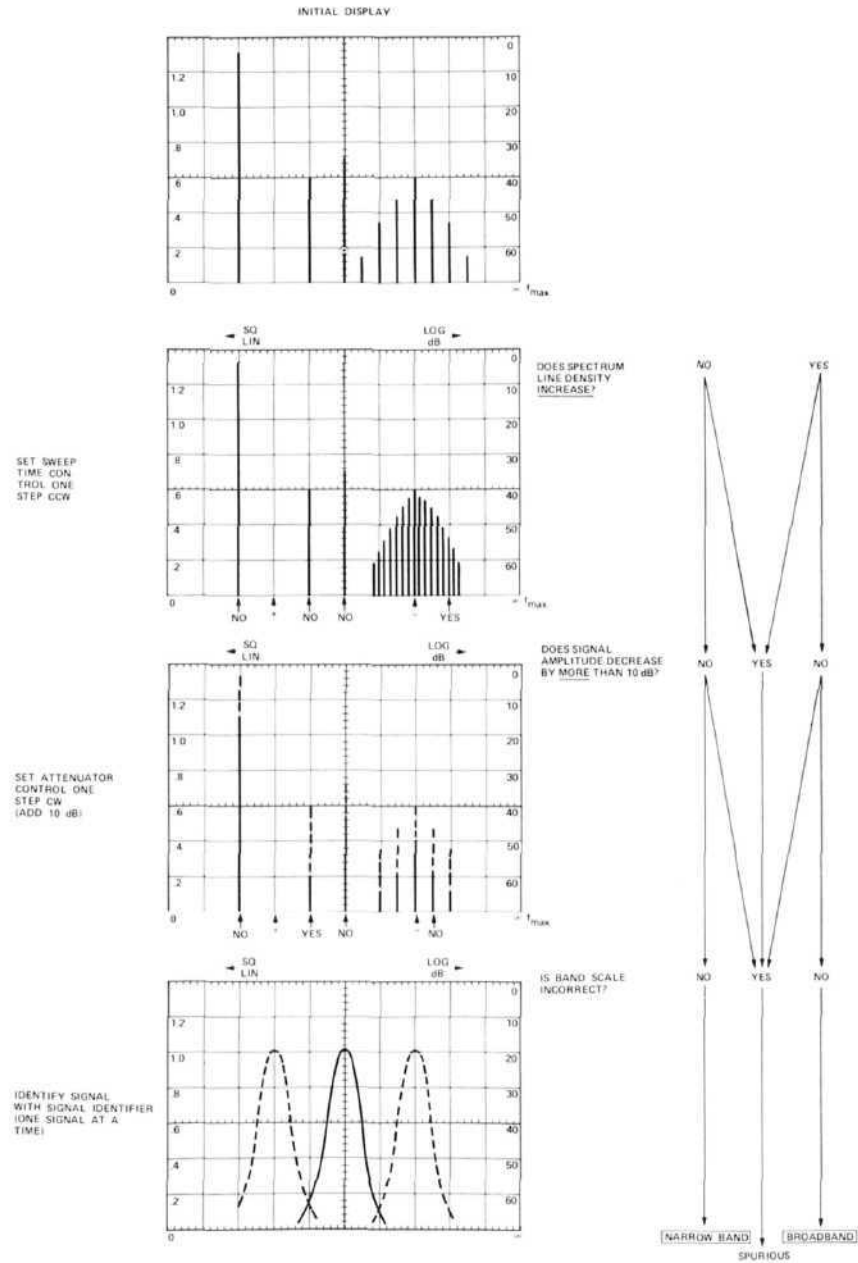

6. METHOD CS01, CONDUCTED SUSCEPTIBILITY, 30 Hz TO 50 kHz, POWER LEAD

The objective of this method is to determine the susceptibility of the test device to electromagnetic energy injected on its power leads over the specified frequency range.

6.1 Instruments and Accessories Used

Spectrum Analyzer Tuning Section, Model 8556A Option H11
Spectrum Analyzer IF Section, Model 8552B Option H04
Spectrum Analyzer Display Section, Model 141T
Oscillator, Model 200CD
Rejection Network, Solar Model 7021-1, or equivalent
Isolation Transformer
Amplifier, Solar Model 6552-1A, or equivalent

6.2 Test Setup

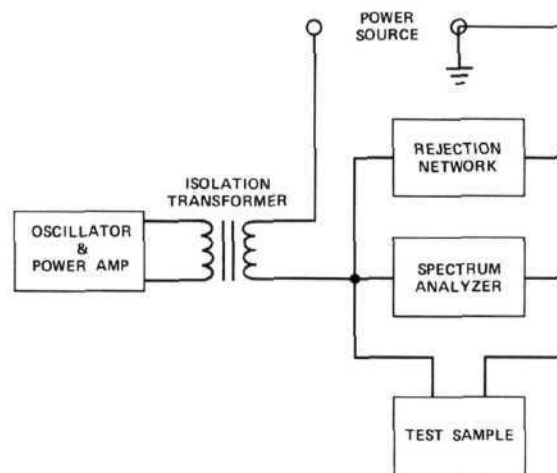

Figure 6A. Test setup for Method CS01. (NOTE: Spectrum analyzer to be used unterminated as a high impedance voltmeter.)

6.3 Control Settings and CRT Calibration

The spectrum analyzer will be used as a monitor of the signal level to the test sample. The input should be isolated from the line frequency by a suitable rejection network.

Since individual requirements will vary, the following control settings will be given as a guide only. These settings will give a full screen indication with a 10 volt input signal level.

Scan Width	0–10f
Per Division	20 Hz (30 Hz – 200 Hz range) 200 Hz (200 Hz – 2 kHz range) 2 kHz (2 kHz – 20 kHz range)
Bandwidth	10 Hz (30 Hz – 200 Hz range) 30 Hz (200 Hz – 2 kHz range) 300 Hz (2 kHz – 20 kHz range)
Input Level	-10 dBV
Log Ref Level	+140 dB μ V

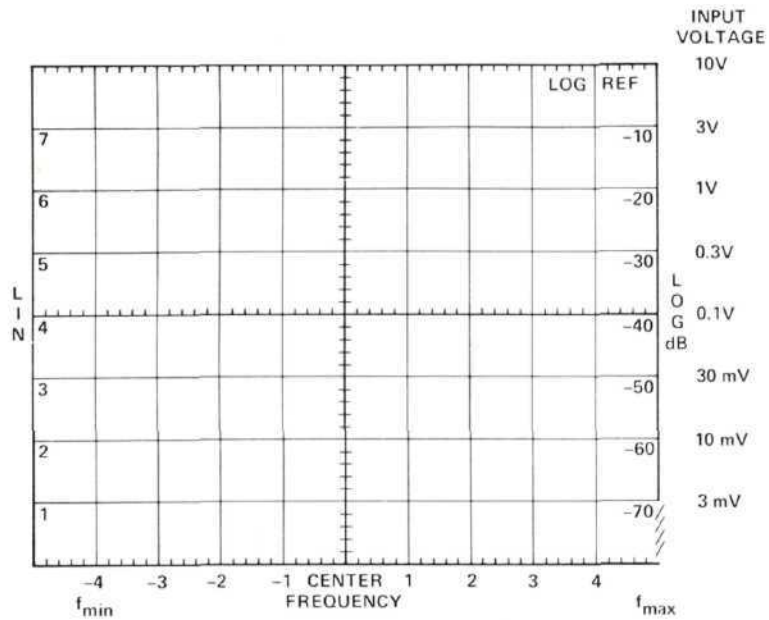

Figure 6B.

6.4 Calibrating and Marking Display

A chart similar to Figure 17 of MIL-STD-461A should be drawn with the appropriate values for the test sample. Then, as the oscillator is tuned to each frequency, the level should be set to that given by the chart.

Alternately, they may be transcribed to the CRT graticule for the frequency range of interest.

EXAMPLE:

Assume a supply voltage of 30V to the test sample.

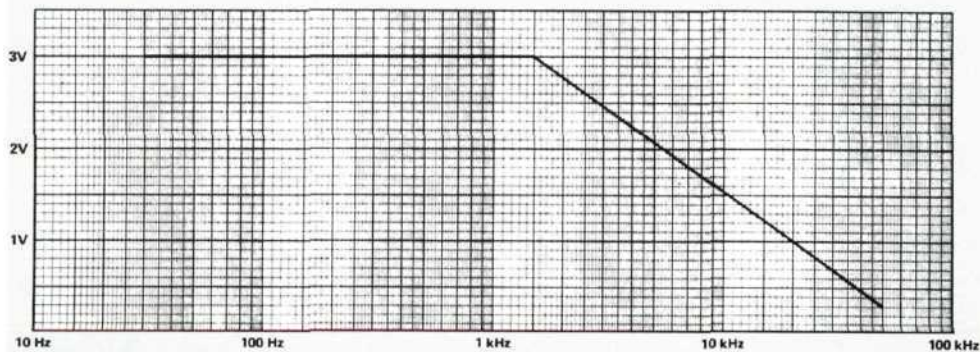

Figure 6C. Chart of injected voltages for 30V supply

From this chart we can now draw the levels directly on the CRT. In this way, it is only necessary to adjust the level to the resulting line for each frequency.

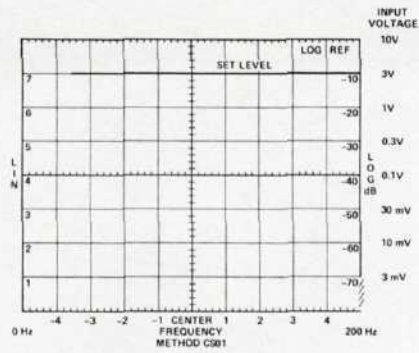

Figure 6D.

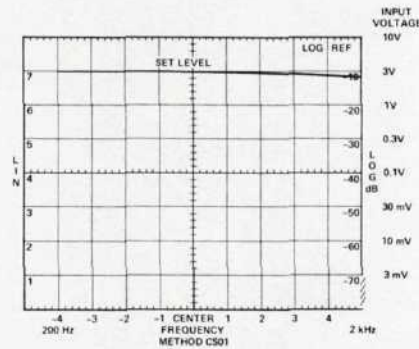

Figure 6E.

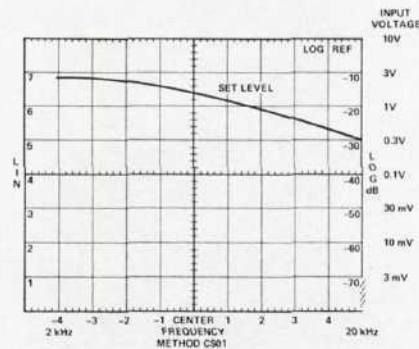

Figure 6F.

These figures are examples only.

6.5 Frequency Calibration

Set all controls as shown in Section 6.3. With no input to the spectrum analyzer, adjust the ZERO ADJ to bring the L0 feedthrough signal to the left edge of the CRT.

6.6 Precautions

Before making any measurements, begin with the oscillator set to low power, and increase its level to the desired output. This will prevent inadvertent overload of the spectrum analyzer input.

6.7 Signal Identification

Does not apply.

7. METHOD CS02, CONDUCTED SUSCEPTIBILITY, 50 kHz TO 400 MHz, POWER LEADS

The objective of this method is to determine if the test sample is susceptible to electromagnetic energy injected on its power leads.

7.1 Instruments and Accessories Used

Spectrum Analyzer Tuning Section, Model 8553B
 Spectrum Analyzer Tuning Section, Model 8554L
 Spectrum Analyzer IF Section, Model 8552B Option H04
 Spectrum Analyzer Display Section, Model 141T
 Oscillator, Model 651B
 Signal Generator, Model 608E
 Amplifier, Instruments for Industry Model M5000L, or equivalent
 Attenuator, 30 dB Model 8491A Option 30
 Coupling Capacitor, Solar Model 7011-1, or equivalent

7.2 Test Setup

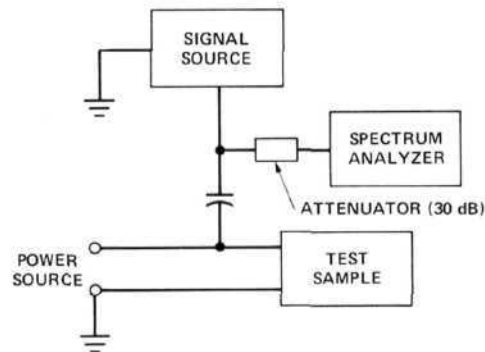

Figure 7A.

7.3 Control Settings and CRT Calibration

7.3.1 50 kHz to 50 MHz. The model 8553B Tuning Section should be used for measurements in this range.

Measurement Number	Frequency Range		Bandwidth	Scan Width	Center Frequency	Log Ref* Level
	fmin	fmax				
1	50 kHz	500 kHz	10 kHz	50 kHz/Div	250 kHz	110 dB μ V
2	500 kHz	5 MHz	10 kHz	500 kHz/Div	2.5 MHz	110 dB μ V
3	5 MHz	50 MHz	100 kHz	5 MHz/Div	25 MHz	110 dB μ V

*Input attenuation ≥ 10 dB

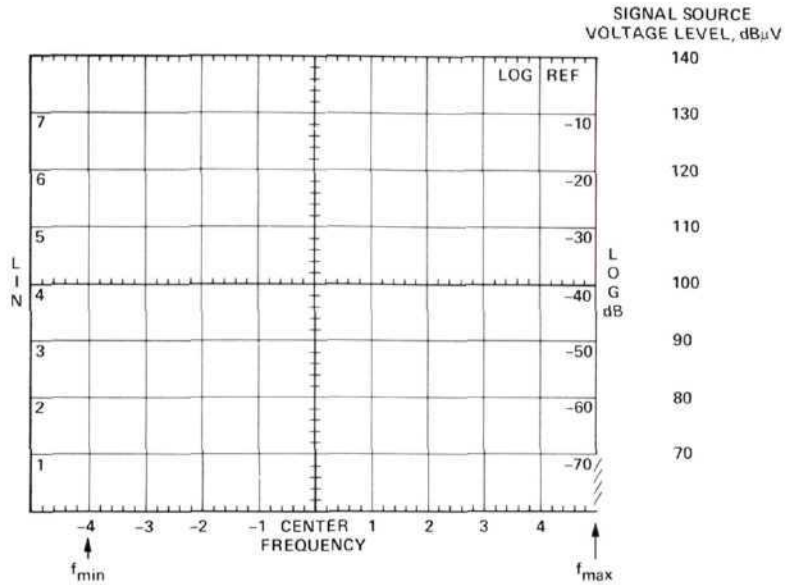

Figure 7B.

NOTE: This figure takes into account the 30 dB attenuator (model 8491A) at the input to the spectrum analyzer.

7.3.2 50 MHz to 400 MHz. The Model 8554L Tuning Section is used for this measurement range.

Scan Width 50 MHz/Div
 Center Frequency 250 MHz
 Bandwidth 300 kHz
 Log Ref Level 110 dBμV
 Input Attenuator 20 dB

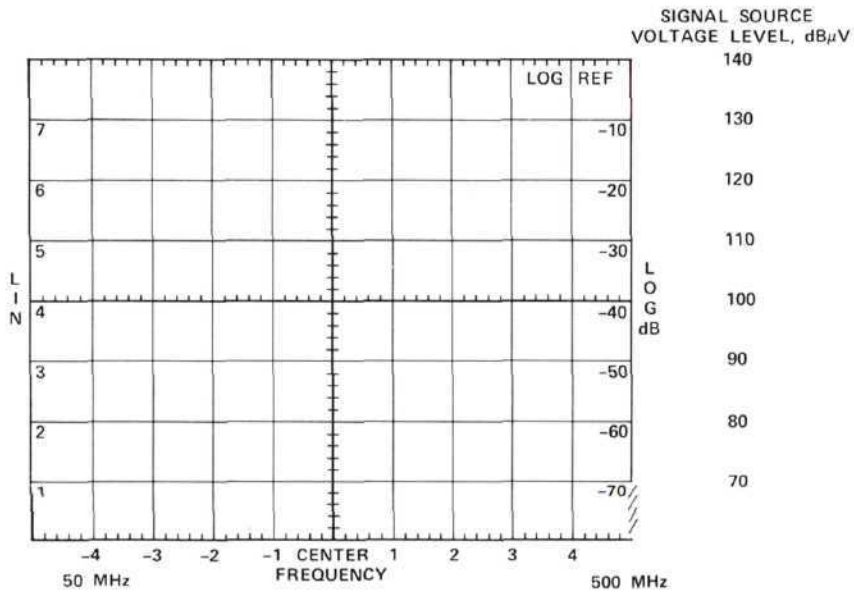

Figure 7C.

NOTE: This figure takes into account the 30 dB attenuator (Model 8491A) at the input to the spectrum analyzer.

7.4 Calibrating and Marking Display

The signal source is to be adjusted for an output of 7 volts rms. This is +137 dB μ V. Therefore, the display may be marked with a horizontal line 3 dB from the top as a reference.

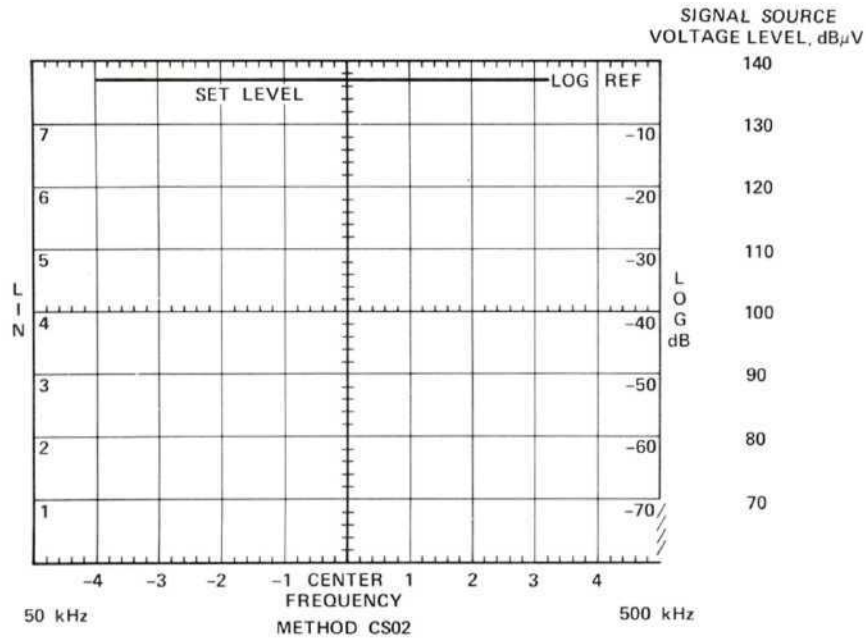

Figure 7D.

7.5 Frequency Calibration

In each case, the FREQUENCY or FINE TUNE controls should be used to set the L0 feedthrough signal to the left edge of the CRT.

7.6 Precautions

Be sure to set ≥ 10 dB input attenuation on the spectrum analyzer. Also, approach each power level setting from the low power side to avoid inadvertent overload of the spectrum analyzer.

7.7 Signal Identification

Not applicable.

8. METHOD RE01, RADIATED EMISSION, 30 Hz TO 30 kHz, MAGNETIC FIELD

The objective of this method is to measure the magnetic field radiated from electrical and electro-mechanical equipment.

8.1 Instruments and Accessories Used

Spectrum Analyzer Tuning Section, Model 8556A Option H11
 Spectrum Analyzer IF Section, Model 8552B Option H04
 Spectrum Analyzer Display Section, Model 141T
 Loop Sensor, as described in MIL-STD-461

8.2 Test Setup

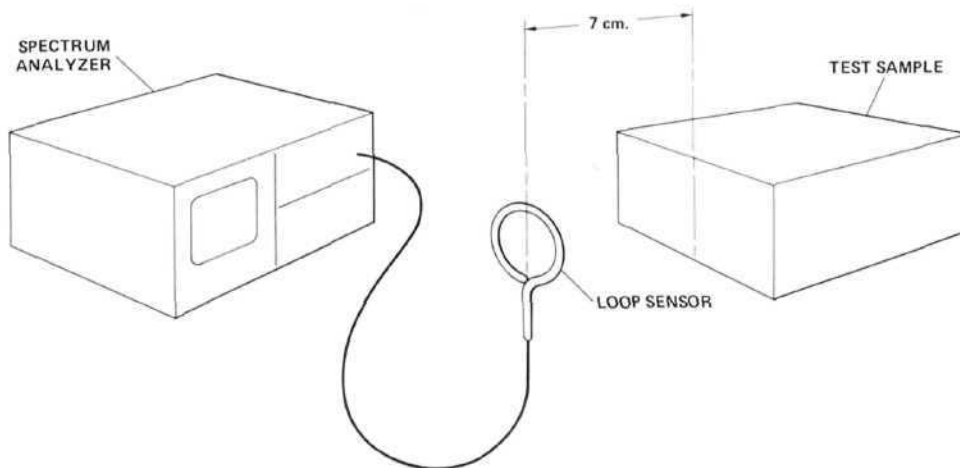

Figure 8A.

8.3 Control Settings and CRT Calibration

Measurement Number	Frequency Range		Bandwidth	Scan Width (0-10f mode)	Input Level	Log Ref Level
	fmin	fmax				
1	20 Hz*	200 Hz	10 Hz	20 Hz/Div	-60 dBV	60 dB μ V
2	200 Hz	2 kHz	10 Hz	200 Hz/Div	-60 dBV	60 dB μ V
3	5 kHz**	50 kHz	10 Hz	5 kHz/Div	-60 dBV	60 dB μ V

*Measure only from 30 Hz
 **Measure from 2 kHz to 30 kHz

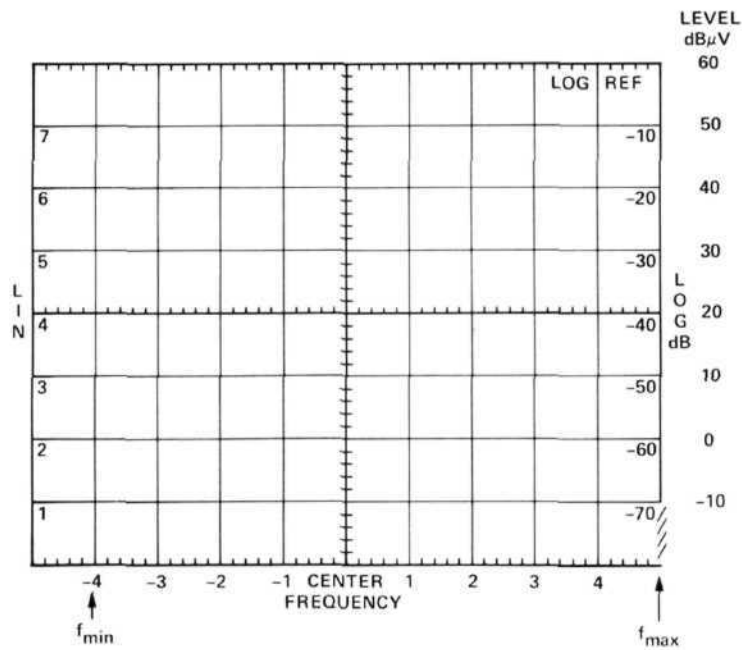

Figure 8B.

8.4 Calibrating and Marking Display

Frequency	MIL-STD-461 Limits (dBpT)	Loop Correction Factor (dBpT/ μ V)	Spectrum Analyzer Input Signal = Specification Limit + Correction Factor (dB μ V)
30 Hz	140	80	60
100 Hz	119	69.5	49.5
200 Hz	106	63.8	42.2
400 Hz	95	57.7	37.3
1 kHz	79	50.2	28.8
2 kHz	67	44.2	22.8
5 kHz	51	36.4	14.6
10 kHz	39	30.4	8.6
20 kHz	27	24.4	2.6
30 kHz	20	20.5	-0.5

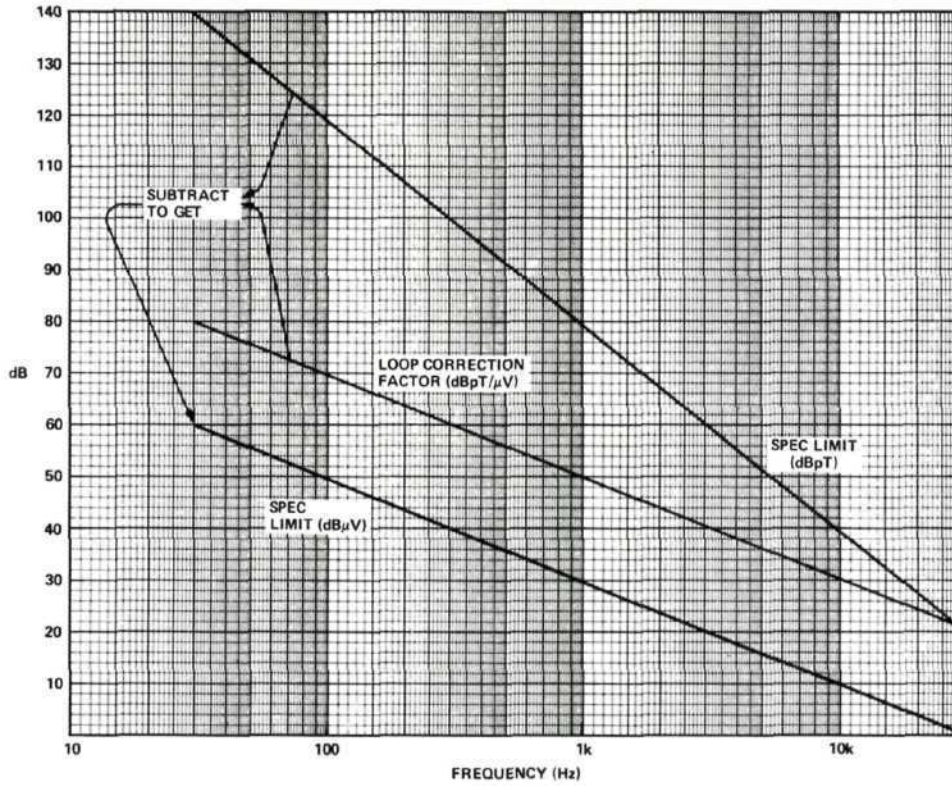

Figure 8C.

Subtract loop correction factor in dBpT/ μ V from MIL-STD specification limits in dBpT to obtain spectrum analyzer input levels in dB μ V. See table and curves above.

Copy the values onto the spectrum analyzer display. (See the following examples).

EXAMPLES

Measurement 1

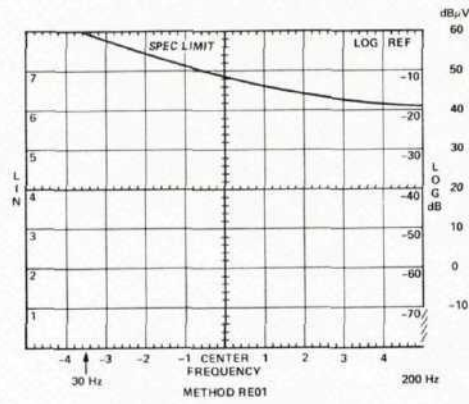

Figure 8D.

CRT calibration is obtained from control settings in Section 8.3. Specification limit is copied from preceding figure.

Measurement 2

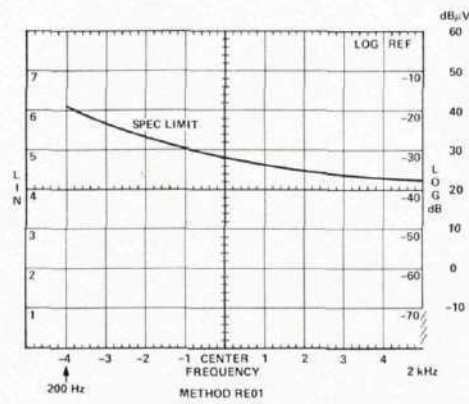

Figure 8E.

Measurement 3

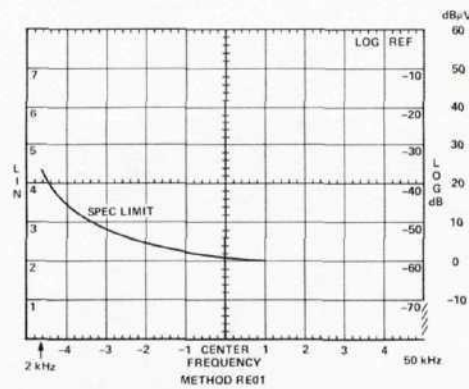

Figure 8F.

8.5 Frequency Calibration

Set all controls as shown in Section 8.3. With no input to the spectrum analyzer, adjust the ZERO ADJ to bring the L0 feedthrough signal to the left edge of the CRT.

8.6 Precautions

Before making any measurements, set the Input Level control to -10 dBV and scan the 0–200 kHz frequency range to insure that no strong signals are present which will overload the spectrum analyzer.

Change the Input Level setting in 10 dB steps until the -60 dBV is reached. If any signal goes off screen, it is an emission above the specification limit.

8.7 Signal Identification

As the Input Level is stepped in Section 8.6, observe the signal levels on the CRT. If any signals change by more than 10 dB per step, they are spurious signals. (Any signal which is within specification will not cause spurious responses.)

9. METHOD RE02, RADIATED EMISSION, 14 kHz TO 10 GHz, ELECTRIC FIELD

The objective of this method is to measure the radiated electric field emissions from the test sample.

9.1 Instruments and Accessories Used

Spectrum Analyzer Tuning Section, Model 8553B
Spectrum Analyzer Tuning Section, Model 8555A
Spectrum Analyzer IF Section, Model 8552B Option H04
Spectrum Analyzer Display Section, Model 141T
Automatic Preselector, Model 8445A
Step Attenuator, Model 354A
Rod Antenna, Singer Model 95010-1, or equivalent
Biconical Antenna, EMCO Model 3104, or equivalent
Log Spiral Antenna, EMCO Model 3101, or equivalent
Log Spiral Antenna, EMCO Model 3102, or equivalent
Amplifier, Model 8447D
TWTA, Watkins-Johnson Model 295, or equivalent
TWTA, Watkins-Johnson Model 296, or equivalent
TWTA, Watkins-Johnson Model 297, or equivalent
10 μ FD Feedthrough Capacitor

9.2 Test Setup

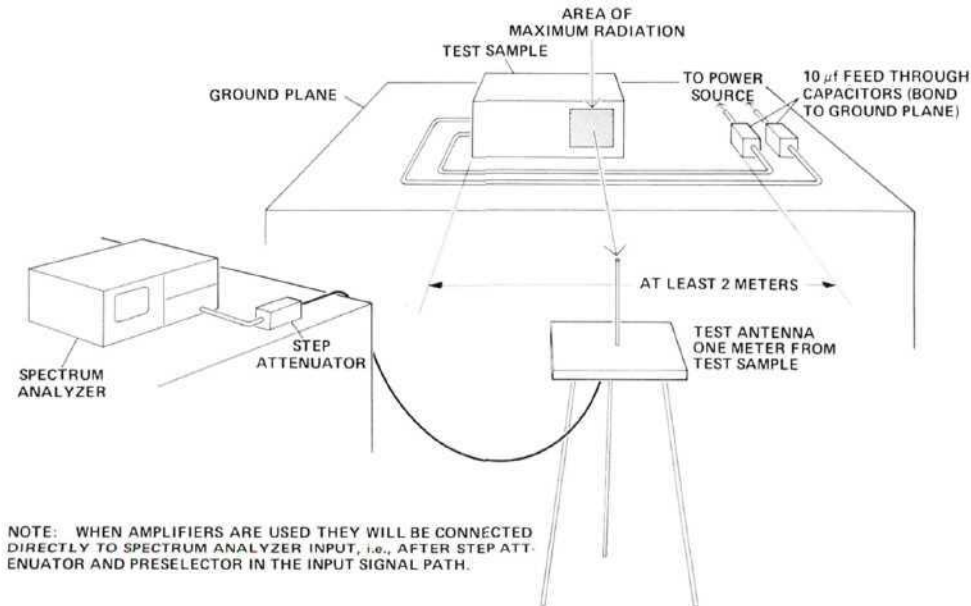

Figure 9A. Typical test setup for radiated measurements.

9.3 Control Settings and CRT Calibration

9.3.1 14 kHz to 20 MHz. In this frequency range, use the following equipment: Model 8553B Tuning Section and Model 95010-1 Antenna.

Measurement Number	Frequency Range		Bandwidth	Scan Width	Center Frequency	Log Ref Level
	fmin	fmax				
1	10 kHz*	100 kHz	3 kHz	10 kHz/Div	50 kHz	90 dB μ V
2	100 kHz	1 MHz	30 kHz	100 kHz/Div	500 kHz	90 dB μ V
3	2 MHz**	20 MHz	100 kHz	2 MHz/Div	10 MHz	90 dB μ V

*Measure from 14 kHz
**Measure from 1 MHz

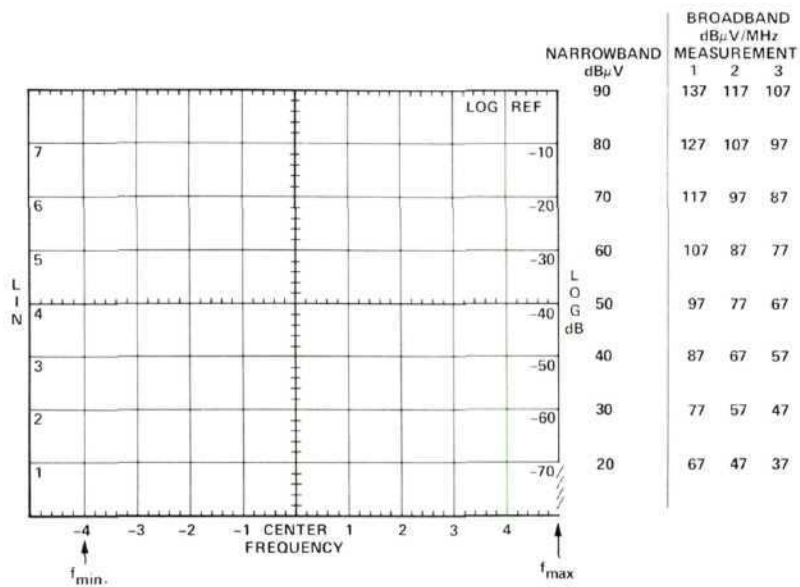

Figure 9B.

9.3.2 20 MHz to 200 MHz. In this range, use the following equipment:

- Model 8555A Tuning Section
- Model 8445A Automatic Preselector
- Model 8447D Amplifier
- Model 3104 Antenna

Band	Frequency Range		Bandwidth	Scan Width	Center Frequency	Log Ref Level
	fmin	fmax				
0.01—2.05	20 MHz	200 MHz	100 kHz	20 MHz/Div	100 MHz	90 dB μ V

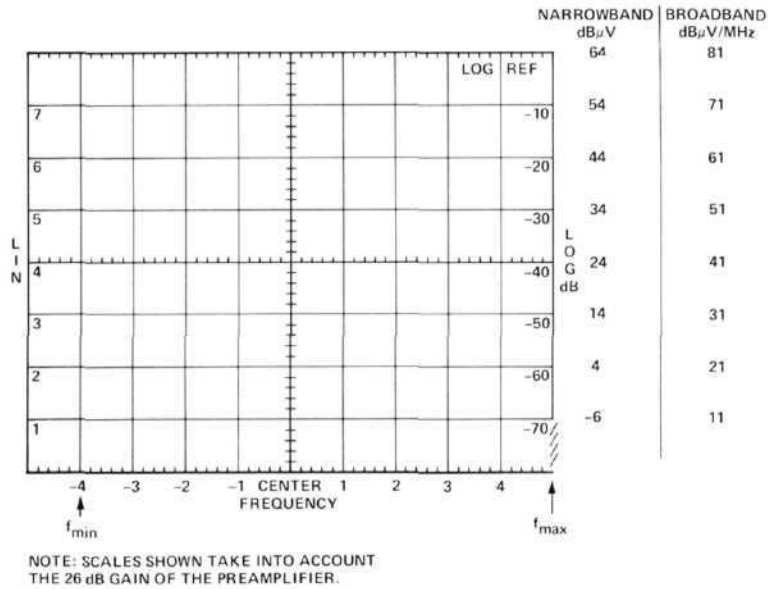

Figure 9C.

9.3.3 200 MHz to 1 GHz. In this range, use the following equipment:

- Model 8555A Tuning Section
- Model 8445A Automatic Preselector
- Model 8447D Amplifier
- Model 3101 Antenna

Band 0.01 – 2.05 GHz
 Frequency Range $f_{min} = 200$ MHz/ $f_{max} = 1$ GHz
 Bandwidth 100 kHz
 Scan Width 100 MHz/Div
 Center Frequency 500 MHz
 Log Ref Level 90 dB μ V

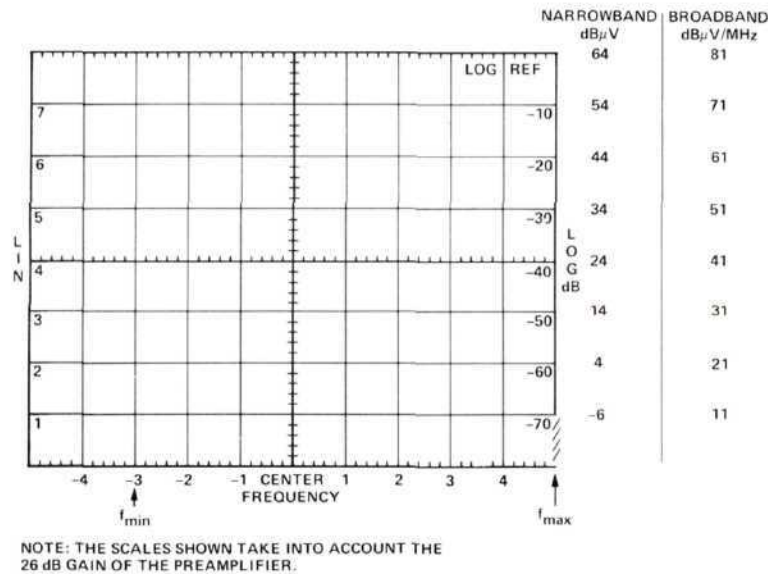

Figure 9D.

9.3.4 1 GHz – 12.4 GHz. In this range, use the following equipment:

- Model 8555A Tuning Section
- Model 8445A Automatic Preselector
- Model 3102 Antenna
- Model 295 Amplifier (measurements 3 and 4 only)
- Model 296 Amplifier (measurements 5 and 6 only)
- Model 297 Amplifier (measurement 7 only)

Measurement Number	Band	Frequency Range		Bandwidth	Scan Width	Center Frequency	Log Ref Level
		fmin	fmax				
1	0.01–2.05	1	2 GHz*	10 kHz	100 MHz/Div	1.5 GHz	60 dB μ V
2	1.50–3.55	1.8	2.0 GHz	10 kHz	20 MHz/Div	1.9 GHz	60 dB μ V
3	1.50–3.55	2.0	3.0 GHz	10 kHz	100 MHz/Div	2.5 GHz	90 dB μ V
4	2.60–4.65	3.0	4.0 GHz	10 kHz	100 MHz/Div	3.5 GHz	90 dB μ V
5	2.07–6.15	4.0	6.0 GHz	10 kHz	200 MHz/Div	5 GHz	90 dB μ V
6	4.13–10.25	6.0	8.0 GHz	10 kHz	200 MHz/Div	7 GHz	90 dB μ V
7	6.17–10.25	8.0	10.0 GHz	10 kHz	200 MHz/Div	9 GHz	90 dB μ V

*Measure from 1 GHz to 1.8 GHz only

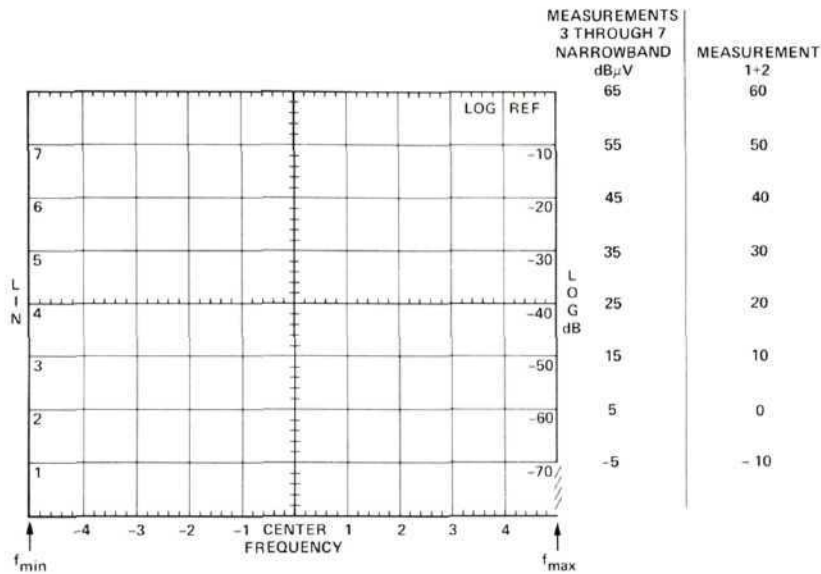

NOTE: SCALE SHOWN TAKES INTO ACCOUNT 25 dB GAIN IN THE TWT AMPLIFIER (MEASUREMENTS 3 THROUGH 7 ONLY).

Figure 9E.

9.4 Calibrating and Marking Display

Frequency	MIL-STD-461 Limits		Antenna Factor (dB/m)	Spectrum Analyzer Input Signal – Spec Limit – Antenna Factor	
	Narrowband (dB μ V/m)	Broadband (dB μ V/m/MHz)		Narrowband (dB μ V)	Broadband (dB μ V/MHz)
14 kHz	35	100	0	35	100
100 kHz	32.5	90.5	0	32.5	90.5
1 MHz	26.5	80	0	26.5	80
20 MHz	20.5	66	0	20.5	66
20 MHz	20.5	66	11.5	9	54.5
25 MHz	20	65	11.7	8.3	53.3
30 MHz	21	64	12	9	52
40 MHz	23	62.5	13.5	9.5	49
50 MHz	24.5	61.5	12.5	12	49
60 MHz	26	60.5	8.5	17.5	52
70 MHz	27	60	7	20	53
80 MHz	28	59.5	8	20	51.5
90 MHz	28.5	59	12	16.5	47
100 MHz	29	58.5	14	15	44.5
120 MHz	30.5	57.5	16	14.5	41.5
130 MHz	31	57	15	16	42
150 MHz	32	56.5	16	16	40.5
180 MHz	33.2	55.5	19	14.2	36.5
200 MHz	34	55	19	15	36
200 MHz	34	55	25.5	8.5	29.5
250 MHz	35.5	57	21.5	14	35.5
300 MHz	36.5	59	18.5	18	40.5
400 MHz	38.5	61.5	19	21.5	42.5
500 MHz	40	63.5	20	20	43.5
600 MHz	41.5	65.5	22	19.5	43.5
800 MHz	43	68	24.5	18.5	43.5
1 GHz	45	70	27	18	43
1 GHz	45	—	26.5	18.5	—
1.5 GHz	47.5	—	30	17.5	—
2.0 GHz	49.5	—	32.5	17	—
2.5 GHz	51	—	34.5	16.5	—
3.0 GHz	52	—	36.3	15.7	—
4.0 GHz	54	—	39	15	—
5.0 GHz	55.5	—	41	14.5	—
6.0 GHz	56.5	—	42.5	14	—
7.0 GHz	57.5	—	44	13.5	—
8.0 GHz	58.5	—	45	13.5	—
9.0 GHz	59.5	—	46	13.5	—
10.0 GHz	60	—	47	13	—

The diagram shows three arrows pointing from the 'Narrowband (dB μ V/m)', 'Broadband (dB μ V/m/MHz)', and 'Antenna Factor (dB/m)' columns to the 'Narrowband (dB μ V)' and 'Broadband (dB μ V/MHz)' columns. Each arrow is labeled 'subtract to get', indicating that the spectrum analyzer input signal is calculated by subtracting the antenna factor from the corresponding MIL-STD-461 limit.

EXAMPLES

14 kHz to 100 kHz

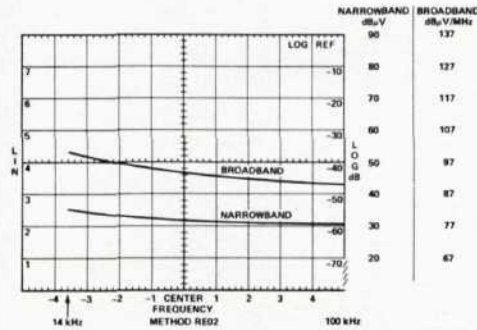

Figure 9H.

Calibration of narrowband signal level due to setting controls as in section 9.3.1.

Broadband signal level calibration is obtained by subtracting Bandwidth Figure B from the dB μ V calibration.

Example: $+90 \text{ dB}\mu\text{V} - (-47 \text{ dBMHz}) = +137 \text{ dB}\mu\text{V}/\text{MHz}$

100 kHz to 1 MHz

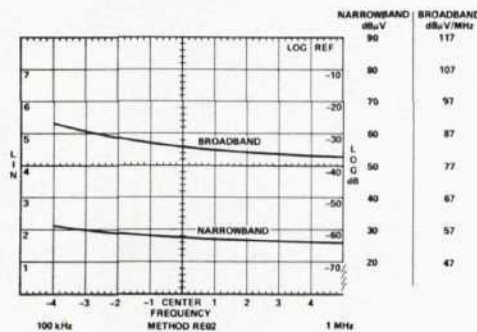

Figure 9I.

NOTE: The exact labeling of the broadband scale depends on the actual bandwidth on the actual bandwidth of your analyzer and should be measured beforehand.

1 MHz to 20 MHz

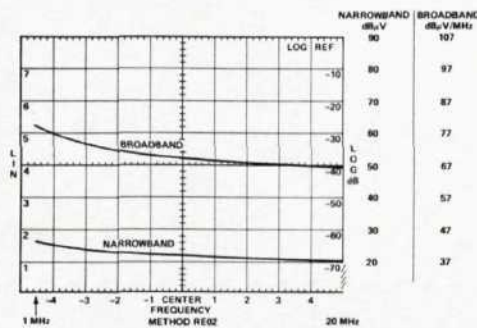

Figure 9J.

Narrowband and broadband limits are copied from table or curves.

Label frequency scale as shown in Section 9.3.

Specification limits, frequencies, and method number may be marked directly on CRT or an overlay may be used. A photo of the spectrum will then contain all information.

FURTHER EXAMPLES

20 MHz to 200 MHz

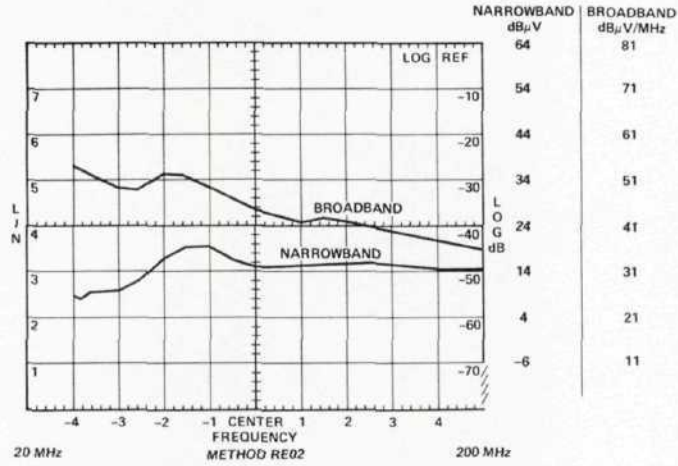

Figure 9K.

200 MHz to 1 GHz

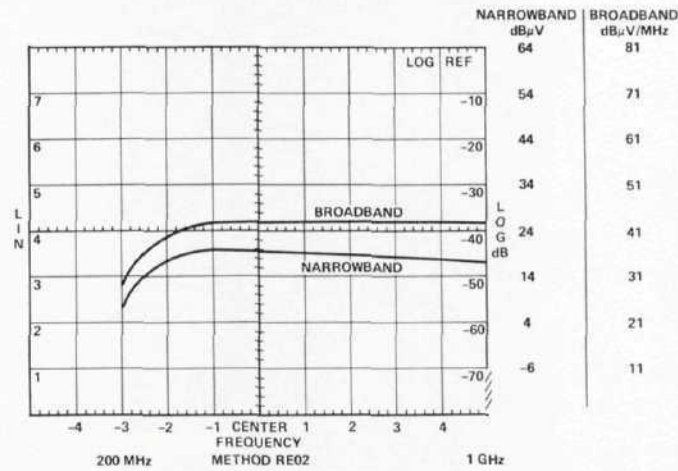

Figure 9L.

1 GHz to 1.8 GHz

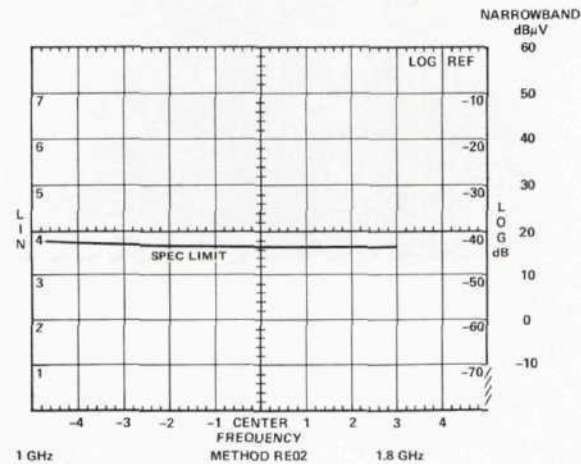

Figure 9M.

FURTHER EXAMPLES

1.8 GHz to 2 GHz

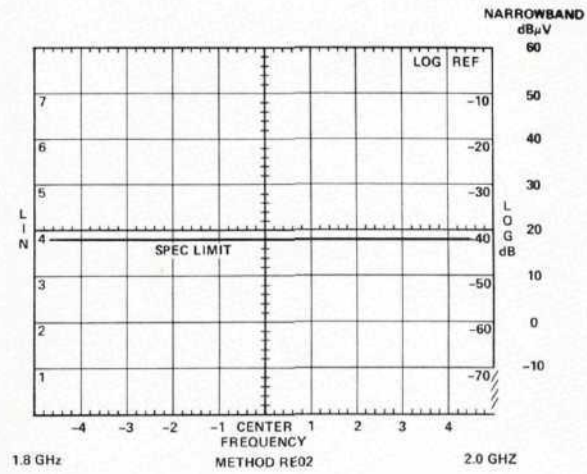

Figure 9N.

2 GHz to 3 GHz

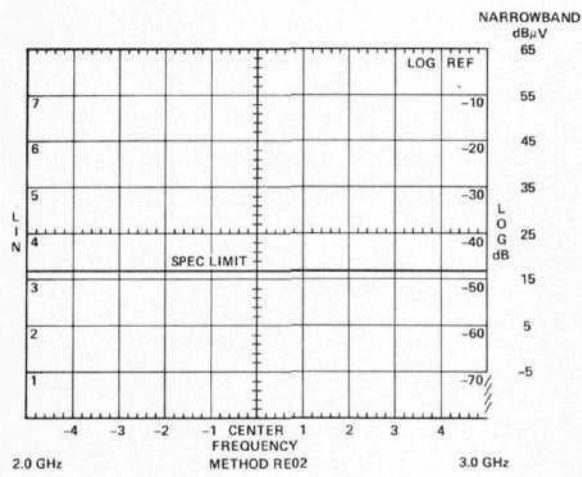

Figure 9O.

3 GHz to 4 GHz

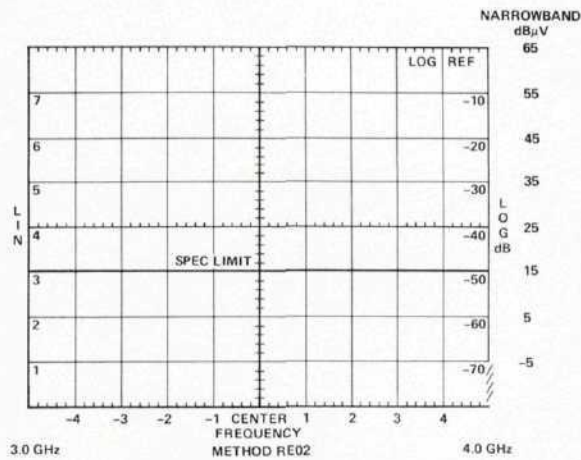

Figure 9P.

FURTHER EXAMPLES

4 GHz to 6 GHz

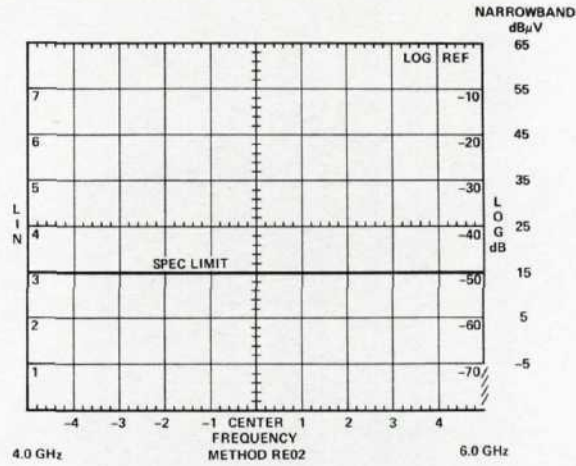

Figure 9Q.

6 GHz to 8 GHz

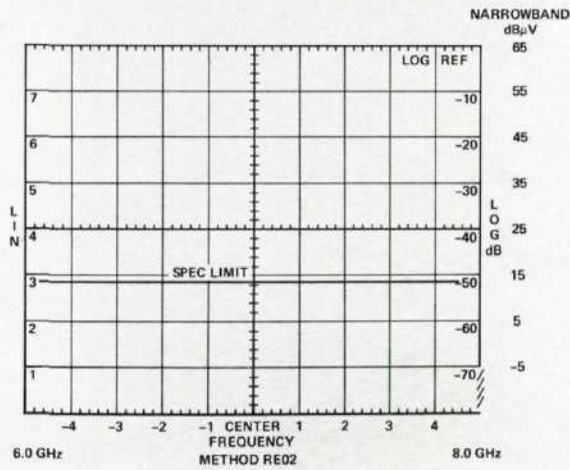

Figure 9R.

8 GHz to 10 GHz

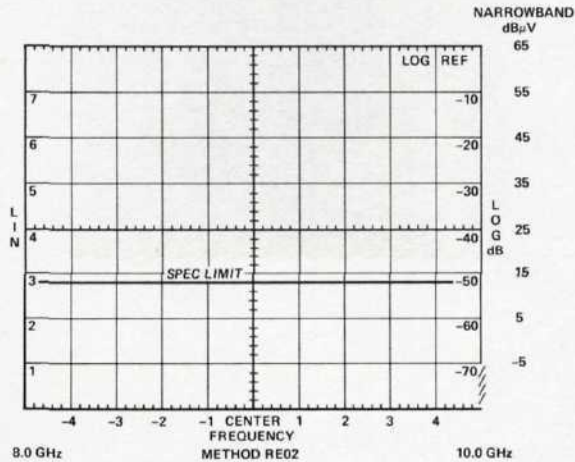

Figure 9S.

9.5 Frequency Calibration

Set all controls as shown in step 9.3. For the 14 kHz to 1.8 GHz range, use the Frequency control to bring the L0 feedthrough signal to the left edge of the CRT. For all higher frequency measurements, use the calibration of the spectrum analyzer dial.

9.6 Precautions

For each frequency range, start with the spectrum analyzer in the Full Scan mode and the step attenuator set to 60 dB. Decrease the attenuation in 10 dB steps while observing the display. Continue removing attenuation until some signals do not behave linearly (i.e., they do not go up in 10 dB steps) or until 0 dB is reached. Use the least amount of attenuation which allows linear behavior while making the measurement. (Be sure to account for the attenuator setting when calculating the signal level.)

NOTE: If broadband noise exists at a level near the specification limit over a wide bandwidth, the recommended rod antenna may become overloaded. In these cases, a passive antenna and band pass filter must be used ahead of any RF amplification.

9.7 Signal Identification

9.7.1 14 kHz to 20 MHz

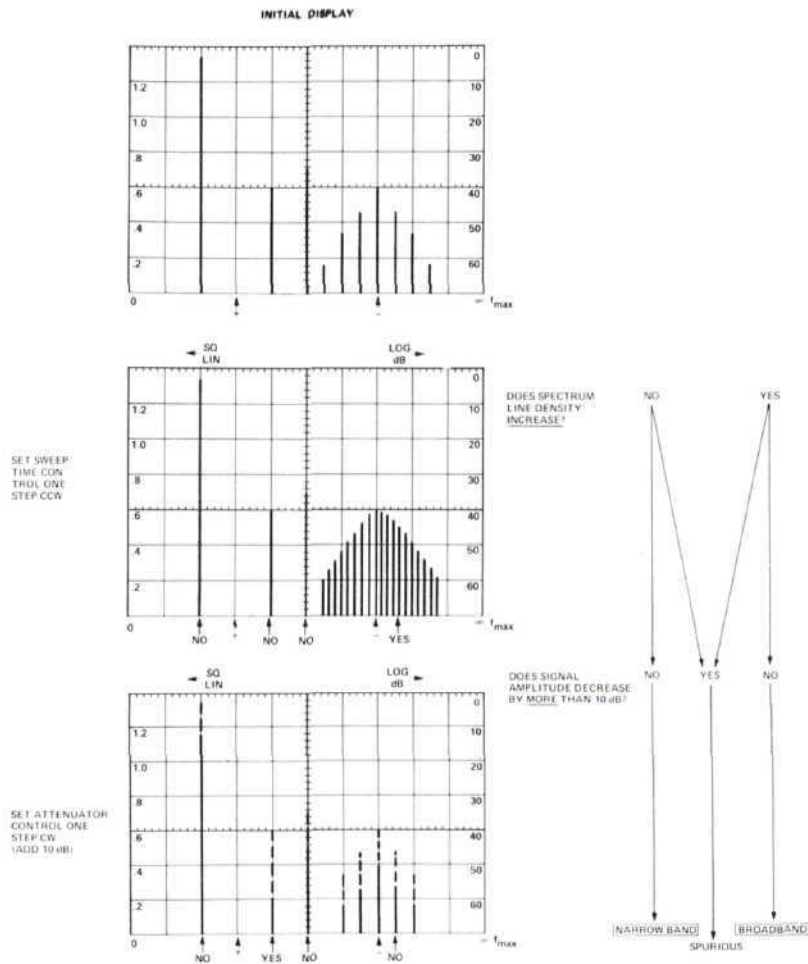

9.7.2 20 MHz to 10 GHz

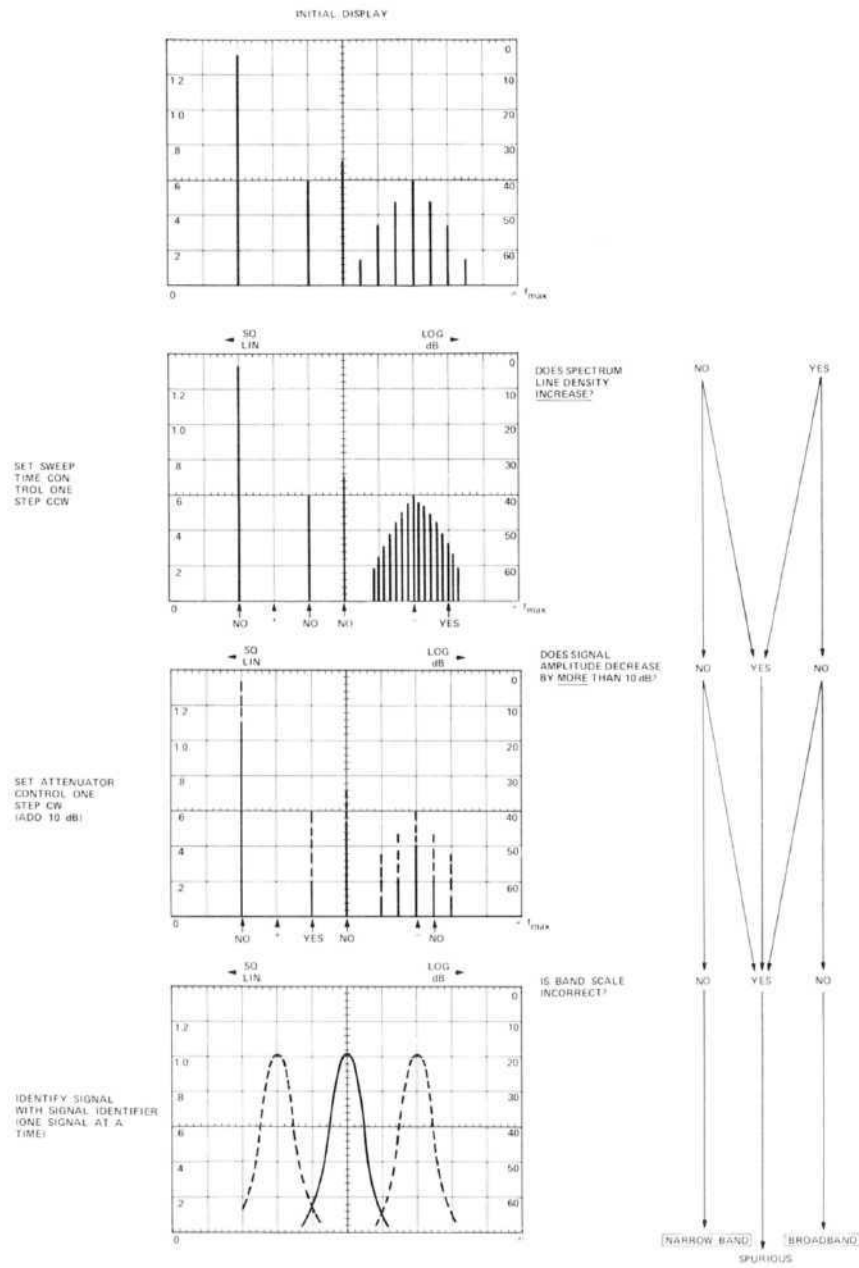

10. METHOD RE03, SPURIOUS AND HARMONIC EMISSIONS, 10 kHz TO 40 GHz

The objective of this method is to measure transmitter spurious and harmonic emissions in the radiated field.

10.1 Instruments and Accessories Used

Spectrum Analyzer Tuning Section, Model 8553B
Spectrum Analyzer Tuning Section, Model 8555A
Spectrum Analyzer IF Section, Model 8552B Option H04
Spectrum Analyzer Display Section, Model 141T
Automatic Preselector, Model 8445A
Step Attenuator, Model 354A
Waveguide Attenuator, Model P382A
Waveguide Attenuator, Model K382A
Waveguide Attenuator, Model R382A
Rod Antenna, Singer Model 95010-1, or equivalent
Biconical Antenna, EMCO Model 3104, or equivalent
Log Spiral Antenna, EMCO Model 3101, or equivalent
Log Spiral Antenna, EMCO Model 3102, or equivalent
Antenna per Drawing ES-DL-201090
Amplifier, Model 8447D
TWTA, Watkins-Johnson Model 295, or equivalent
TWTA, Watkins-Johnson Model 296, or equivalent
TWTA, Watkins-Johnson Model 297, or equivalent
TWTA, Watkins-Johnson Model 393, or equivalent
TWTA, Watkins-Johnson Model 338, or equivalent
Frequency Counter, Model 5340A, or equivalent
Test Oscillator, Model 651B
Signal Generator, Model 608E
Signal Generator, Model 612A
Signal Generator, Model 8614A
Signal Generator, Model 8616A
Signal Generator, Model 618C
Signal Generator, Model 620B
Signal Generator, Model 626A
Signal Generator, Model 628A
Sweep Oscillator Mainframe, Model 8690B
Sweep Oscillator, Model 8696A Option H27
Sweep Oscillator, Model 8697A Option H42
Waveguide Mixer, Model 11517A
Taper Section, Model 11519A
Taper Section, Model 11520A
Directional Coupler, Model K752A
Directional Coupler, Model R752A
Waveguide to Coax Adapter, Model P281A

Optional

Low Pass Filter, Model K362A
Low Pass Filter, Model R362A

10.2 Test Setup

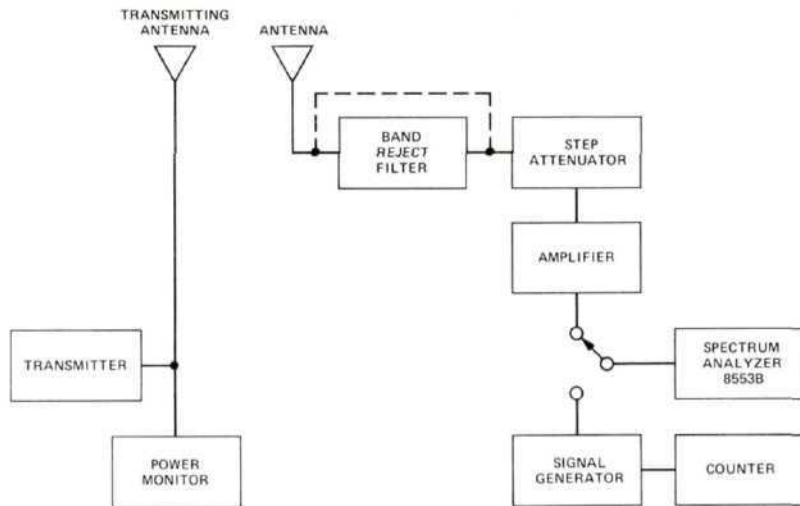

Figure 10A. Test setup 10 kHz – 110 MHz

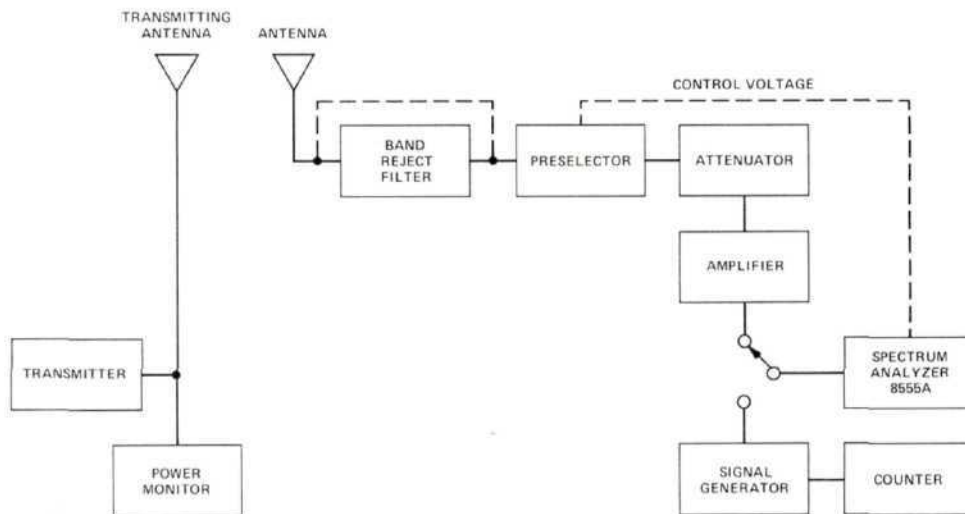

Figure 10B. Test setup 110 MHz – 18 GHz

10.3 Control Settings, Calibration, and Measurement Techniques

10.3.1 10 kHz to 110 MHz. Measure the fundamental output power directly from the CRT in a manner similar to Method RE02 for transmitters which are *not* pulse modulated. That is, measure the spectrum analyzer reading in $\text{dB}\mu\text{V}$, add the antenna factor, add the attenuator setting, and subtract the amplifier gain.

Compute the power from:

$$W = \frac{R^2 E_i^2}{30}$$

Where: R = antenna separation in meters

E_i = field strength in volts/meter

Insert the band reject filter to reject the fundamental frequency and remove attenuation to increase sensitivity. Scan the remainder of the frequency range measuring each emission as above.

For pulse modulated transmitters, obtain a convenient display of the output. Then set the Log Reference Level to give a display at a convenient reference, and connect the signal generator to the input.

Modulate the signal generator in a manner similar to the transmitter and set the output level to give a display at the level previously noted. Read the output level in dBm. Add 107 dB to obtain dB μ V and use this figure as the spectrum analyzer input level. Proceed as in the previous case for the remainder of the procedure.

10.3.2 110 MHz to 18 GHz. The procedure in this range is similar to that above. Above 12 GHz, however, the antenna factors are not given and the power at the transmitter needs to be calculated per the formula in MIL-STD-462. For transmitters which are *not* pulse modulated, though, the voltage in dB μ V can be read directly from the spectrum analyzer.

For pulse modulated carriers, use the method given above.

Remember to include the insertion loss of the preselector in your calculations.

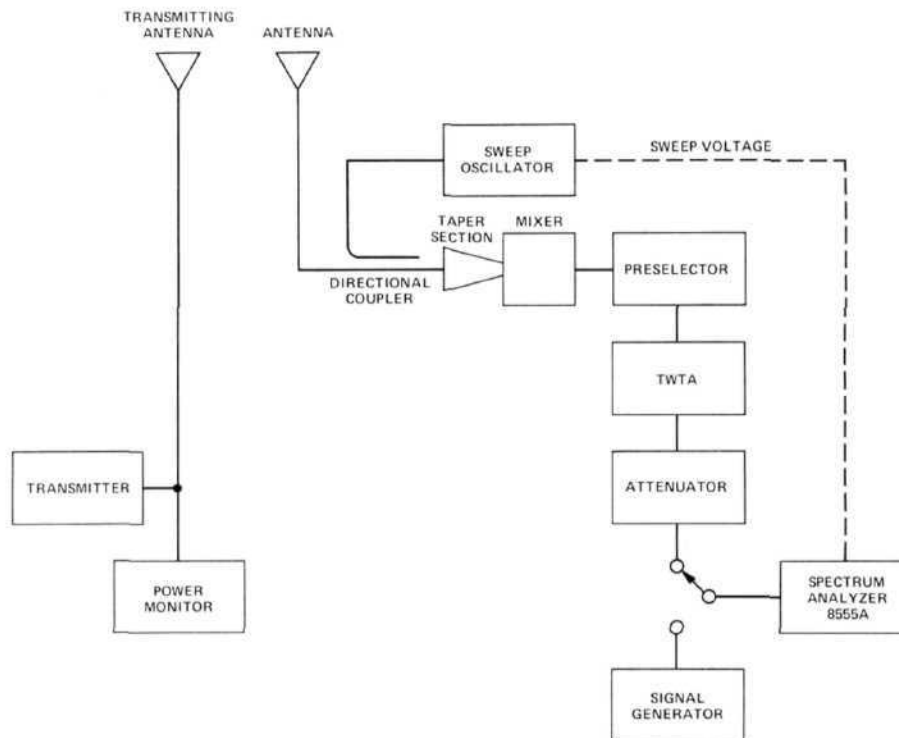

Figure 10C. Test setup 18 GHz – 40 GHz

10.3.3 18 GHz to 40 GHz. For the 18–26.5 GHz range set the sweep oscillator for a sweep in the 20–28.5 GHz range. Use the sweep output on the sweeper to externally scan the spectrum analyzer. (Some readjustment of the Display Adjust controls will be necessary to calibrate the display to cover the horizontal scale.)

The spectrum analyzer should be set for a scan width ≤ 1 MHz/Div with a L0 frequency (tuned on the dial) of about 4 GHz. The spectrum analyzer's L0 is *not* used for mixing in this case, and the narrow scan width will enable the signal identifier circuitry.

To scan a range of frequencies, set the sweep oscillator for a range 2 GHz higher than the desired range. Use the 300 kHz bandwidth on the spectrum analyzer. Since a 2.05 GHz IF frequency is desired, set the preselector to about 2.05 GHz by supplying an external +2.05V signal to the programming connector. (Fine adjustment may be used to “peak” the signals on the display.)

Each signal will appear *twice* on the CRT separated by 4 GHz. These are image responses. To identify the frequency of each signal, narrow the sweep width on the sweep oscillator around that signal and turn on the signal identifier. With the band scale set for the 10+ mixing mode, any signal which identifies with the smaller image to the *left* is 2.05 GHz *higher* than the sweep oscillator frequency. Any signal which splits to give the smaller image to the *right* is 2.05 GHz *lower* than the sweep oscillator frequency.

Measure the amplitude of the signal as described previously under pulse modulated carriers.

The method for 26.5 – 40 GHz is identical except the sweep oscillator will be used in the 28.5 – 42 GHz range.

Alternate Method 18–40 GHz

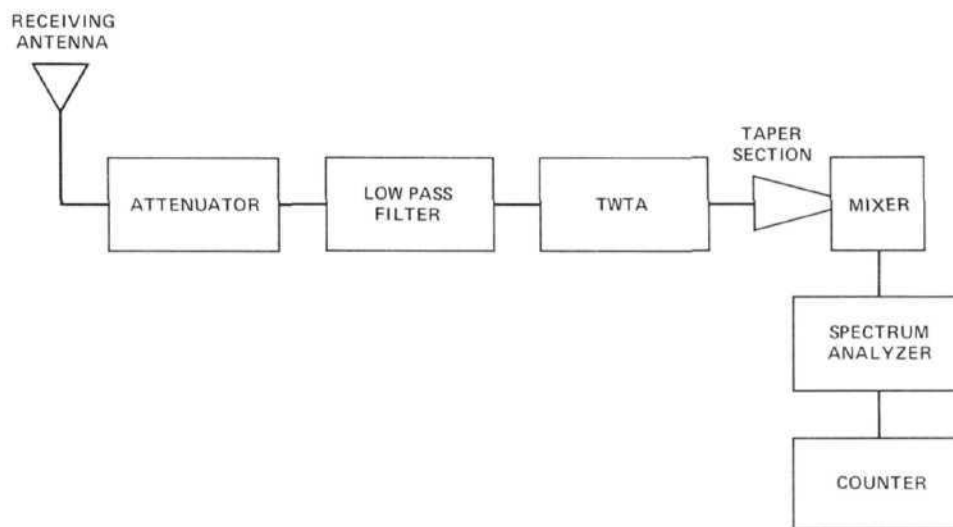

Figure 10D. Test setup 18 – 40 GHz

The internal LO of the spectrum analyzer can be used with slightly lower sensitivity than the above method. However, the signal identifier may be used as described in the instrument operating manual, and narrower bandwidths may be used. Sensitivity will typically be -108 dBm to 26.5 GHz and -100 dBm to 40 GHz in a 300 Hz bandwidth. The measurement technique is otherwise similar.

10.4 Calibrating and Marking Display

For each range a reference may be established using a known output from the signal generator and the calibration marked on the CRT in a manner similar to Method RE02. Then each signal level can be read from the CRT directly in radiated power.

10.5 Frequency Calibration

In the range below 18 GHz, the frequency counter is used to count the signal generator frequency. This will give a direct reading of the signal frequency if the generator is tuned to the same point on the CRT as the un-

known signal. Above 18 GHz, the sweep oscillator frequency is read from the dial scale, and the unknown signal is that frequency ± 2.05 GHz as described in Section 10.3.

10.6 Precautions

Be sure to set the attenuator to maximum attenuation before making any measurements. Then remove attenuation until a convenient display is obtained. Be very careful to insert the band reject filter before looking for spurious outputs.

NOTE: In the 1.8 – 18 GHz range, the preselector will work to reject the fundamental and no reject filter may be required.

10.7 Signal Identification

As previously described.

11. METHOD RE04, RADIATED EMISSION, 20 Hz TO 50 kHz, MAGNETIC FIELD

The objective of this method is to measure magnetic field emissions from the device under test.

11.1 Instruments and Accessories Used

Spectrum Analyzer Tuning Section, Model 8556A Option H11
 Spectrum Analyzer IF Section, Model 8552B Option H04
 Spectrum Analyzer Display Section, Model 141T
 Loop Sensor, as described in MIL-STD-461
 Ten Microfarad Feedthrough Capacitor
 Calibrator, EMCO Model 6402, or equivalent

11.2 Test Setup

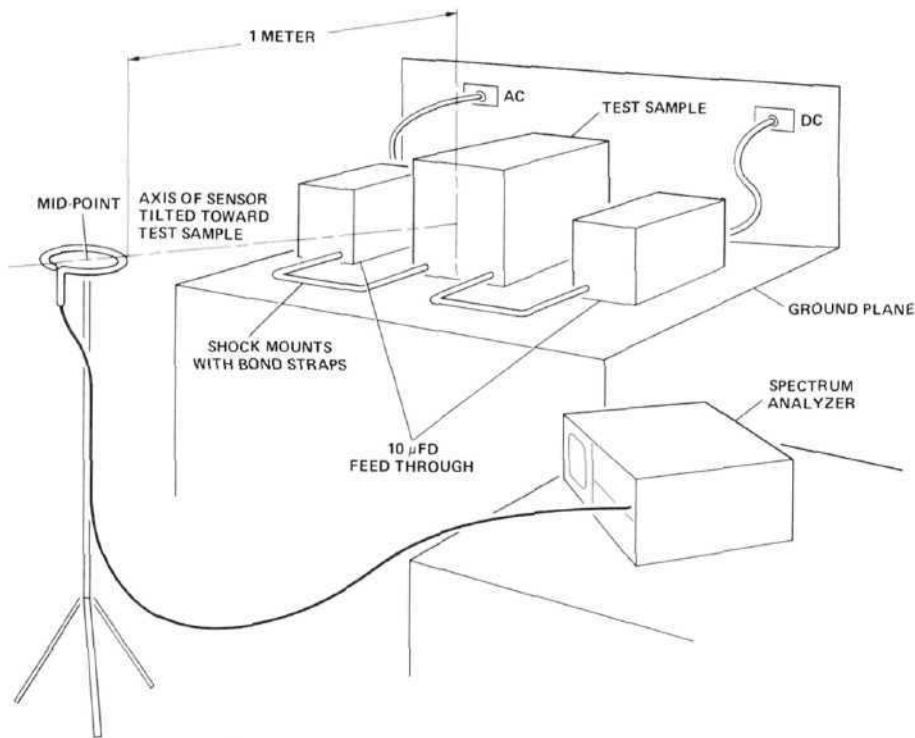

Figure 11A. Typical test setup for radiation measurements (magnetic field sensor).

11.3 Control Settings and CRT Calibration

Measurement Number	Frequency Range		Bandwidth	Scan Width (0–10f mode)	Log Ref Level
	fmin	fmax			
1	20 Hz	200 Hz	10 Hz	20 Hz/Div	40 dB μ V
2	200 Hz	2 kHz	10 Hz	200 Hz/Div	40 dB μ V
3	5 kHz*	50 kHz	10 Hz	5 kHz/Div	50 dB μ V

*Measure from 2 kHz

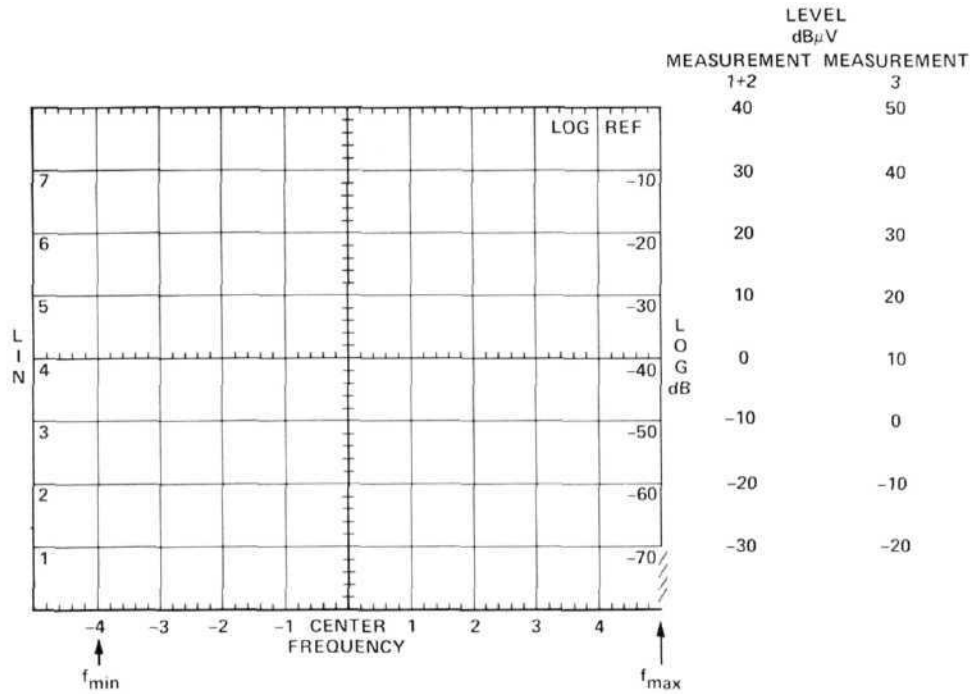

Figure 11B.

11.4 Calibrating and Marking Display

Frequency	MIL-STD-461 Limits (dBpT)	Loop Correction Factor (dBpT/ μ V)	Spectrum Analyzer Input Signal = Specification Limit + Correction Factor (dB μ V)
20 Hz	60	83	-23
100 Hz	60	69.5	-9.5
200 Hz	60	63.8	-3.8
400 Hz	60	57.7	2.3
1 kHz	60	50.2	9.8
2 kHz	60	44.2	15.8
5 kHz	60	36.4	23.6
10 kHz	60	30.4	29.6
20 kHz	60	24.4	35.6
30 kHz	60	20.5	39.5
50 kHz	60	16.0	34.0

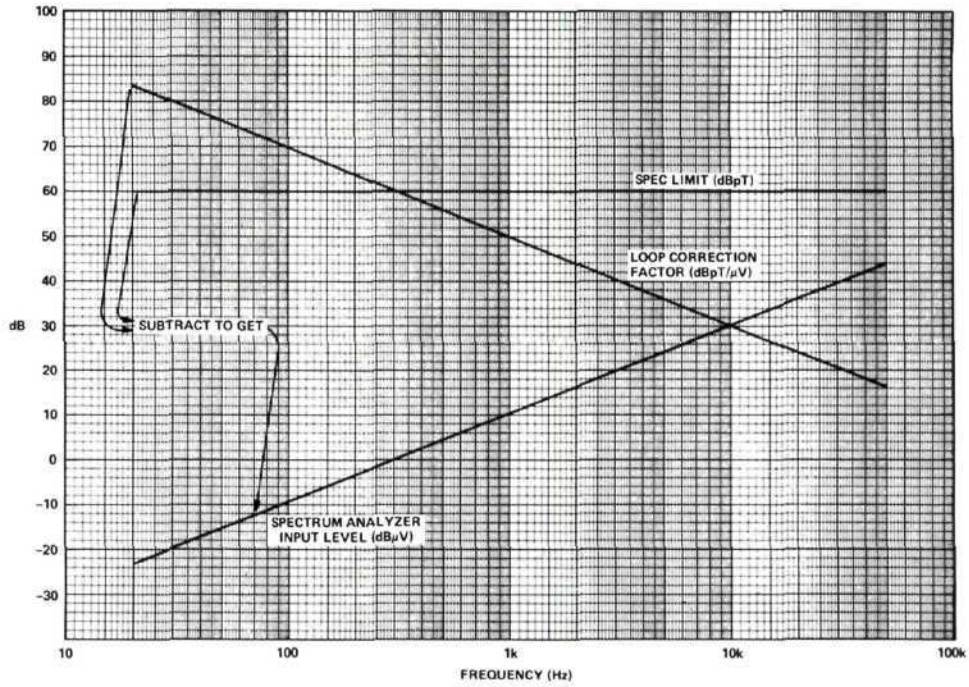

Figure 11C.

Subtract loop correction factor in dBpT/μV from MIL-STD specification limits in dBpT to obtain spectrum analyzer input levels in dBμV. See table and curves above.

Copy the values onto the spectrum analyzer display. (See the following examples.)

EXAMPLES

Measurement 1

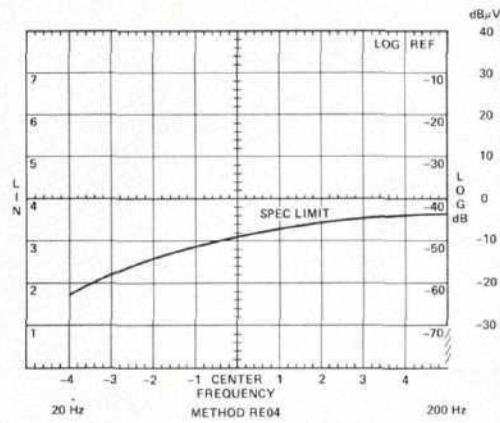

Figure 11D.

CRT calibration is obtained from control settings in Section 11.3. Specification limit is copied from preceding figure.

Measurement 2

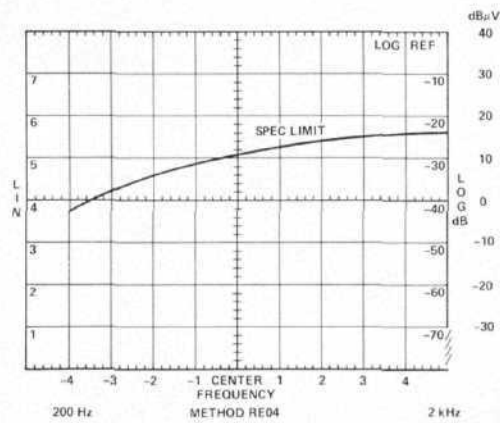

Figure 11E.

Measurement 3

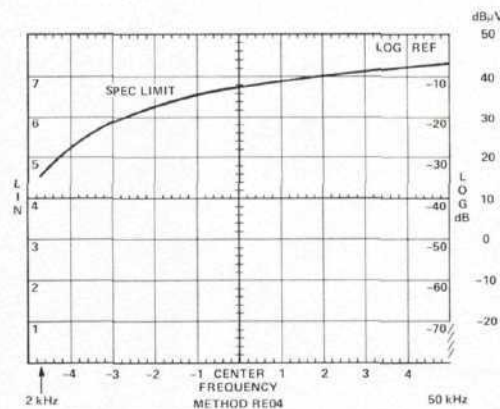

Figure 11F.

11.5 Frequency Calibration

Set all controls as shown in Section 11.3. With no input to the spectrum analyzer, adjust the ZERO ADJ to bring the L0 feedthrough signal to the left edge of the CRT.

11.6 Precautions

Before making any measurements, set the INPUT LEVEL control to -10 dBV, and scan the 0–200 kHz frequency range to insure that no strong signals are present which will overload the spectrum analyzer.

Change the INPUT level setting in 10 dB steps until -60 dBV is reached. If any signal goes above 50 dB μ V, it is above the specification limit at any point.

11.7 Signal Identification

As the INPUT LEVEL is stepped in Section 11.6, observe signal levels on the CRT. If any signals change by more than 10 dB per step, they are spurious signals. (Any signal which is within specifications will not cause spurious responses.)

12. METHOD RE05, RADIATED EMISSION, BROADBAND, 150 kHz TO 1 GHz, VEHICLES AND ENGINE-DRIVEN EQUIPMENT

The objective of this method is to measure the broadband interference radiated by vehicles and engine-driven equipment.

12.1 Instruments and Accessories Used

Spectrum Analyzer Tuning Section, Model 8553B
 Spectrum Analyzer Tuning Section, Model 8554L
 Spectrum Analyzer IF Section, Model 8552B Option H04
 Spectrum Analyzer Display Section, Model 141T
 Step Attenuator, Model 355D
 Rod Antenna, Singer Model 95010-1, or equivalent
 Biconical Antenna, EMCO, Model 3104, or equivalent
 Log Spiral Antenna, EMCO, Model 3101, or equivalent
 Amplifier, Model 8447D

12.2 Test Setup

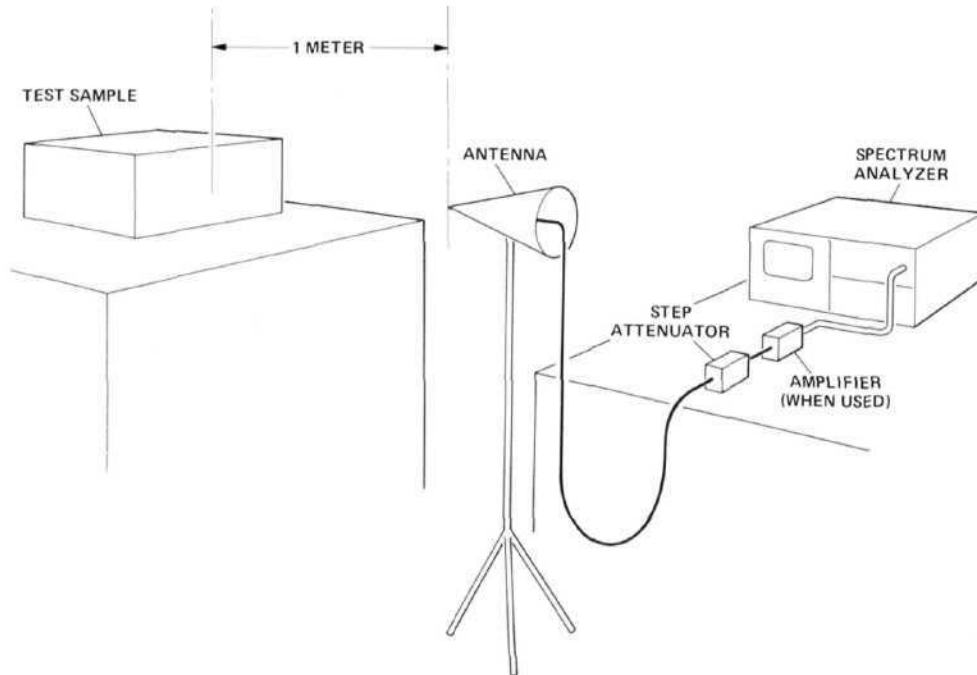

Figure 12A.

12.3 Control Settings and CRT Calibration

12.3.1 150 kHz to 20 MHz. In this range, use the following equipment:

Model 8553B Tuning Section
 Model 95010-1 Antenna

Measurement Number	Frequency Range		Bandwidth	Scan Width	Center Frequency	Log Ref Level
	fmin	fmax				
1	200 kHz*	2 MHz	30 kHz	200 kHz/Div	1 MHz	90 dB μ V
2	2 MHz	20 MHz	100 kHz	2 MHz/Div	10 MHz	90 dB μ V

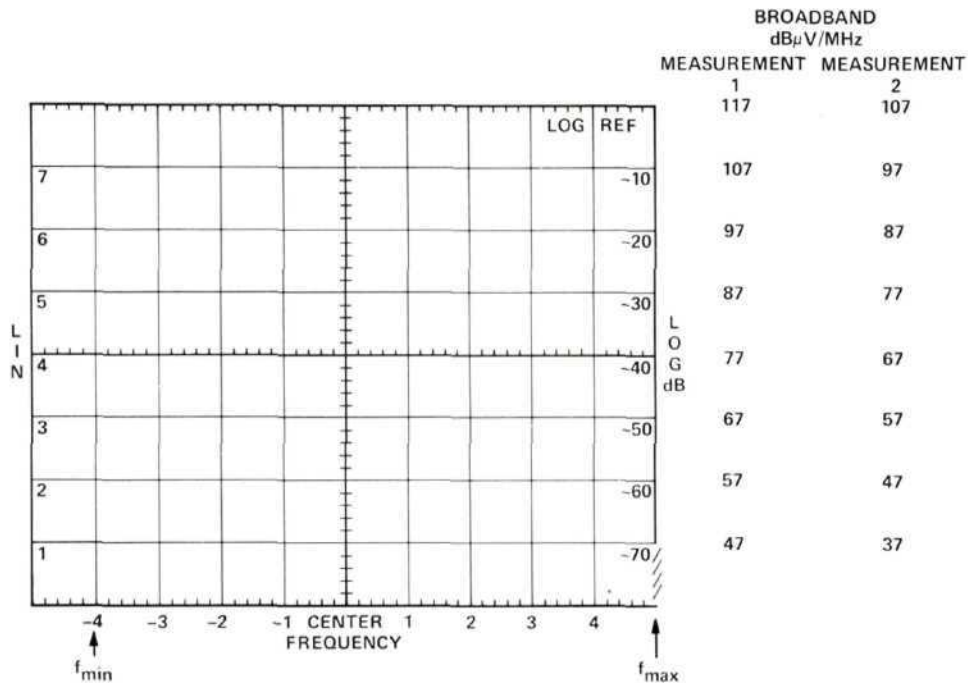
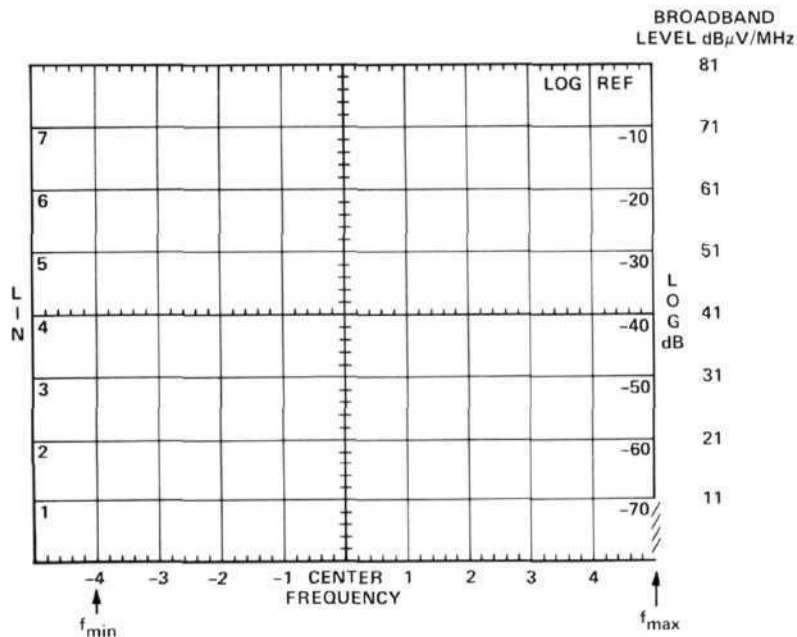

Figure 12B.

12.3.2 20 MHz to 200 MHz. In this range, use the following equipment:

- Model 8554L Tuning Section
- Model 8447D Amplifier
- Model 3104 Antenna

Frequency Range		Bandwidth	Scan Width	Center Frequency	Log Ref Level
fmin	fmax				
20 MHz	200 MHz	100 kHz	20 MHz/Div	100 MHz	90 dB μ V



NOTE: SCALE SHOWN TAKES INTO ACCOUNT THE 26 dB GAIN OF THE PREAMPLIFIER.

Figure 12C.

12.3.3 200 MHz to 1 GHz. In this range, use the following equipment:

Model 8554L Tuning Section
 Model 8447D Amplifier
 Model 3101 Antenna

Frequency Range	fmin = 200 MHz fmax = 1 GHz
Bandwidth	100 kHz
Scan Width	100 MHz/Div
Center Frequency	500 MHz
Log Ref Level	90 dB μ V

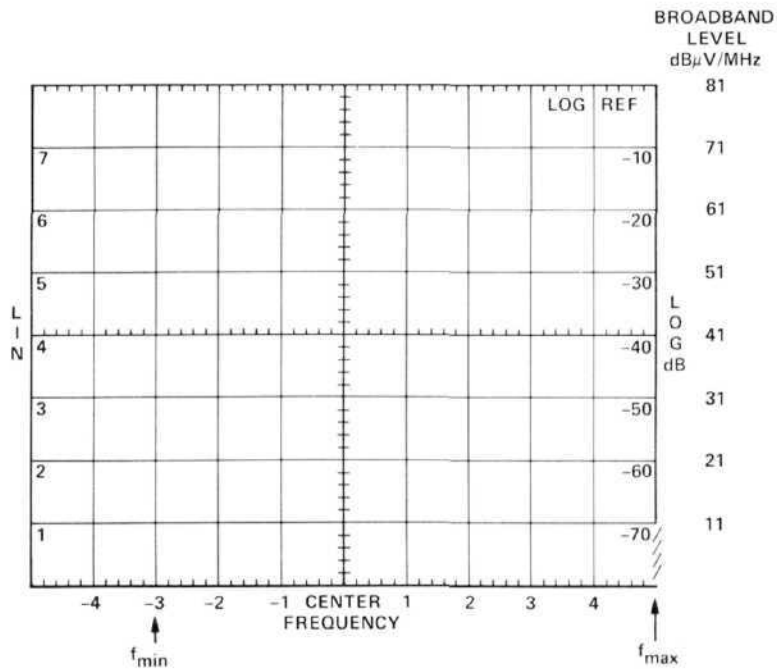

NOTE: THE SCALE SHOWN TAKES INTO ACCOUNT THE 26 dB GAIN OF THE PREAMPLIFIER.

Figure 12D.

12.4 Calibrating and Marking Display

Frequency	MIL-STD-461 Limits (dB μ V/m/MHz)	Antenna Factor (dB/m)	Spectrum Analyzer Input Level = Spec Limit - Antenna Factor (dB μ V/MHz)
150 kHz	88.6	0	88.6
1 MHz	80	0	80
20 MHz	66	0	66
20 MHz	66	11.5	54.5
25 MHz	65	11.7	53.3
30 MHz	64	12	52
40 MHz	62.5	13.5	49
50 MHz	61.5	12.5	49
60 MHz	60.5	8.5	52
70 MHz	60	7	53
80 MHz	59.5	8	51.5
90 MHz	59	12	47
100 MHz	58.5	14	44.5
120 MHz	57.5	16	41.5
130 MHz	57	15	42
150 MHz	56.5	16	40.5
180 MHz	55.5	19	36.5
200 MHz	55	19	36
200 MHz	55	25.5	29.5
250 MHz	57	21.5	35.5
300 MHz	59	18.5	40.5
400 MHz	61.5	19	42.5
500 MHz	63.5	20	43.5
600 MHz	65.5	22	43.5
800 MHz	68	24.5	43.5
1 GHz	70	27	43

subtract to get

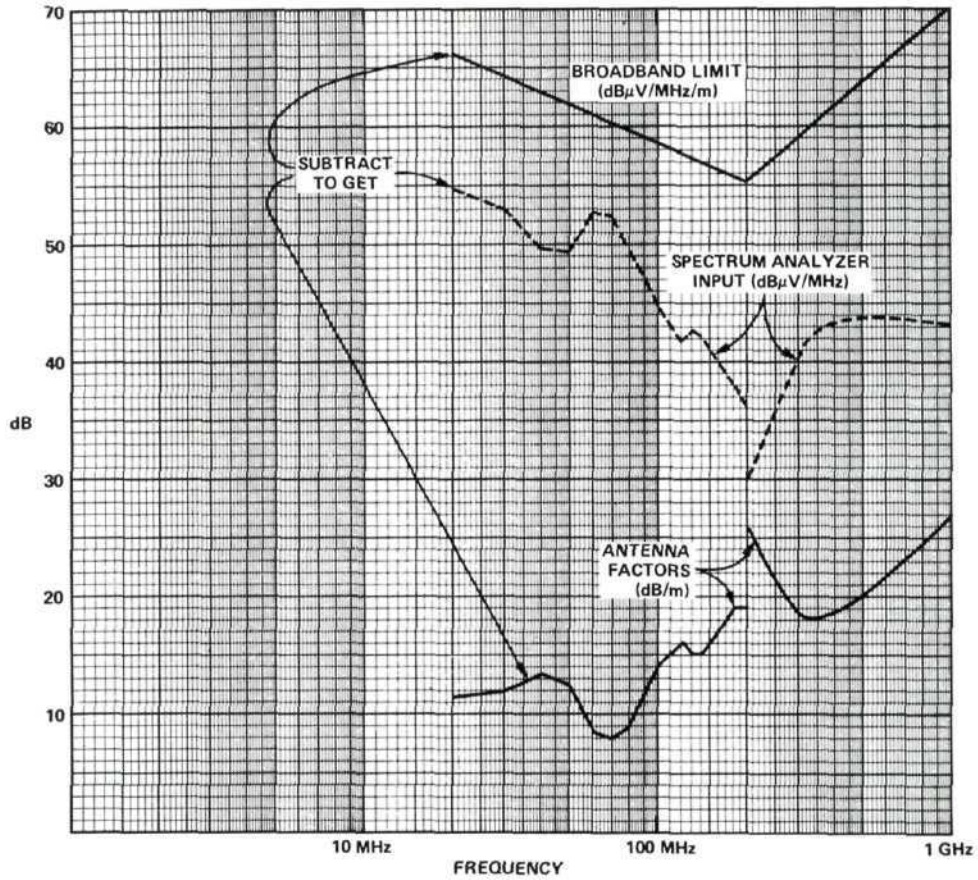

Figure 12E.

Subtract antenna factor (dB/m) of your antenna from MIL-STD limits in $\text{dB}\mu\text{V}/\text{m}/\text{MHz}$ to obtain spectrum analyzer input signal level in $\text{dB}\mu\text{V}/\text{MHz}$. See tables and curves above.

Then, copy the values obtained onto the spectrum analyzer display. See the following examples.

EXAMPLES

150 kHz to 2 MHz

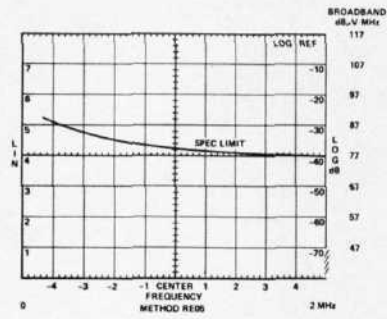

Figure 12F.

Broadband signal level calibration is obtained by subtracting Bandwidth Figure B from the dB μ V calibration obtained from control settings in Section 12.3.1.

Example: +90 dB μ V - (-27 dBMHz) = +117 dB μ V/MHz

2 MHz – 20 MHz

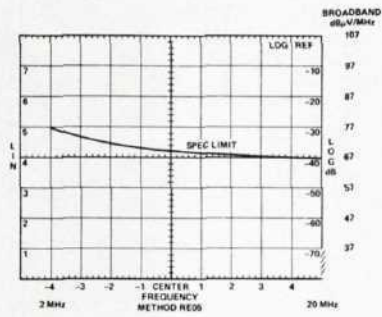

Figure 12G.

NOTE: The exact labeling of the broadband scale depends on the actual bandwidth of your analyzer and should be measured beforehand.

20 MHz – 200 MHz

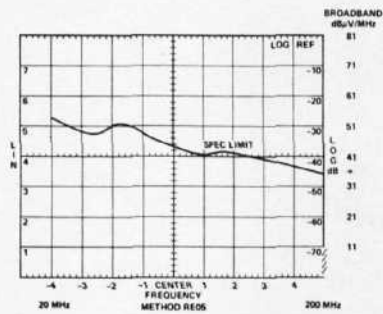

Figure 12H.

Broadband limits are copied from table or curves. Label frequency scale as shown in Section 12.3.

200 MHz – 1 GHz

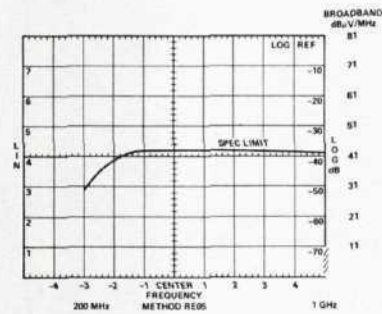

Figure 12I.

Specification limits, frequencies, and method number may be marked directly on CRT or an overlay may be used. A photo of the spectrum will then contain all information.

12.5 Frequency Calibration

Set all controls as shown in step 12.3. With no signal input, use the FREQUENCY control to bring the L0 feedthrough signal to the left edge of the CRT.

12.6 Precautions

For each frequency range start with the spectrum analyzer in the full scan mode and the step attenuator set to 60 dB. Decrease the attenuation in 10 dB steps while observing the display. Continue removing attenuation until some signals do not behave linearly (i.e., they do not increase in 10 dB steps) or until 0 dB is reached. Use the least amount of attenuation which allows linear behavior while making the measurement. (Be sure to account for the attenuator setting when calculating the signal level.)

NOTE: The recommended rod antenna may become overloaded at a level below the specification limit if the input noise exists over a wide band of frequencies. In these cases, a passive antenna and bandpass filter must be used ahead of any RF amplifiers.

12.7 Signal identification

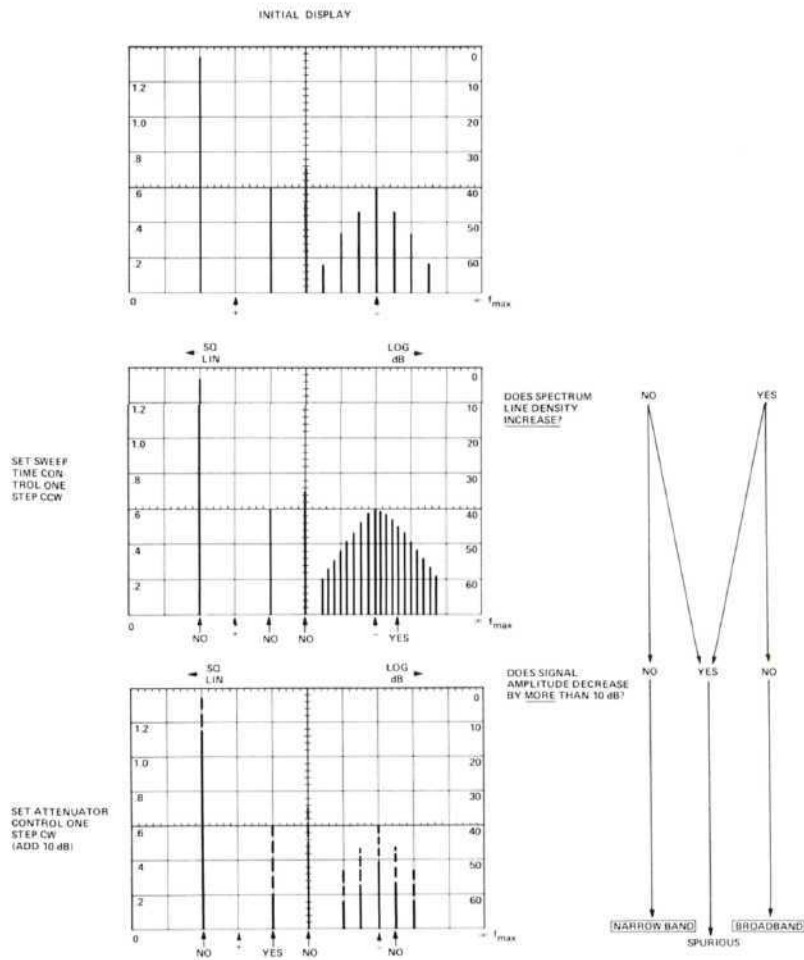

13. METHOD RE06, RADIATED EMISSION, 14 kHz TO 1 GHz, OVERHEAD POWER LINES

The objective of this method is to measure the interference radiated from overhead power lines. The limits shown in this method are those for fair weather. The techniques, however, are identical for wet weather.

13.1 Instruments and Accessories Used

Spectrum Analyzer Tuning Section, Model 8553B
Spectrum Analyzer Tuning Section, Model 8554L
Spectrum Analyzer IF Section, Model 8552B Option H04
Spectrum Analyzer Display Section, Model 141T
Step Attenuator, Model 355D
Rod Antenna, Singer Model 95010-1, or equivalent
Biconical Antenna, EMCO, Model 3104, or equivalent
Log Spiral Antenna, EMCO, Model 3101, or equivalent

13.2 Test Setup

Test antenna to be 50 feet from outside phase conductor at a position normal to tower. See MIL-STD-461 Method RE06.

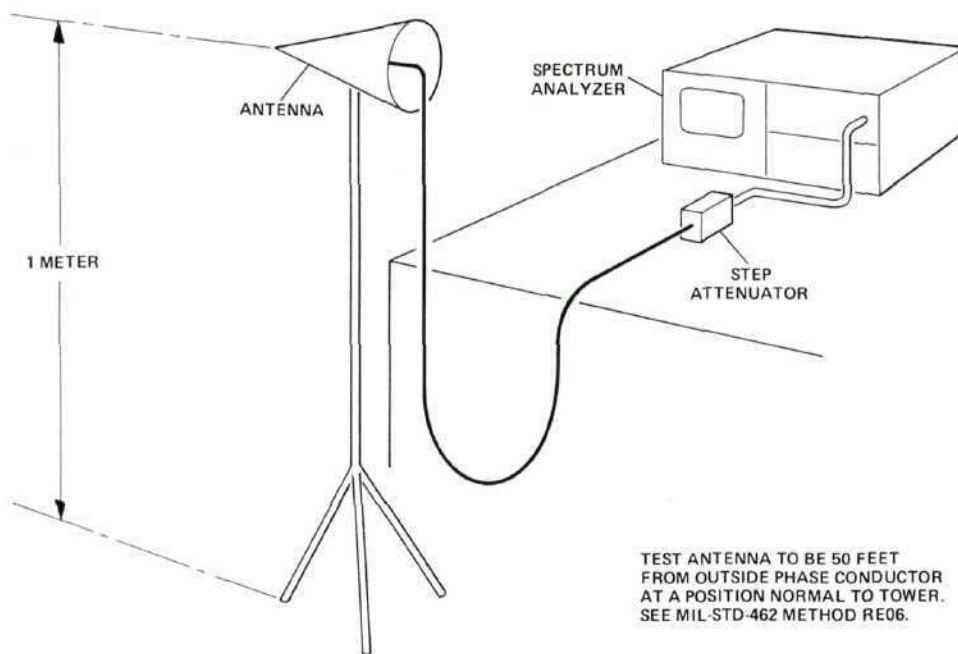

Figure 13A. Test setup for method RE06.

13.3 Control Settings and CRT Calibration

13.3.1 14 kHz to 20 MHz. In this range, use the following equipment:

Model 8553B Tuning Section
Model 95010-1 Antenna

Measurement Number	Frequency Range		Bandwidth	Scan Width	Center Frequency	Log Ref Level
	fmin	fmax				
1	10 kHz*	100 kHz	1 kHz	10 kHz/Div	50 kHz	100 dB μ V
2	100 kHz	1 MHz	10 kHz	100 kHz/Div	500 kHz	100 dB μ V
3	2 MHz**	20 MHz	100 kHz	2 MHz/Div	10 MHz	100 dB μ V

*Measure from 14 kHz
**Measure from 1 MHz

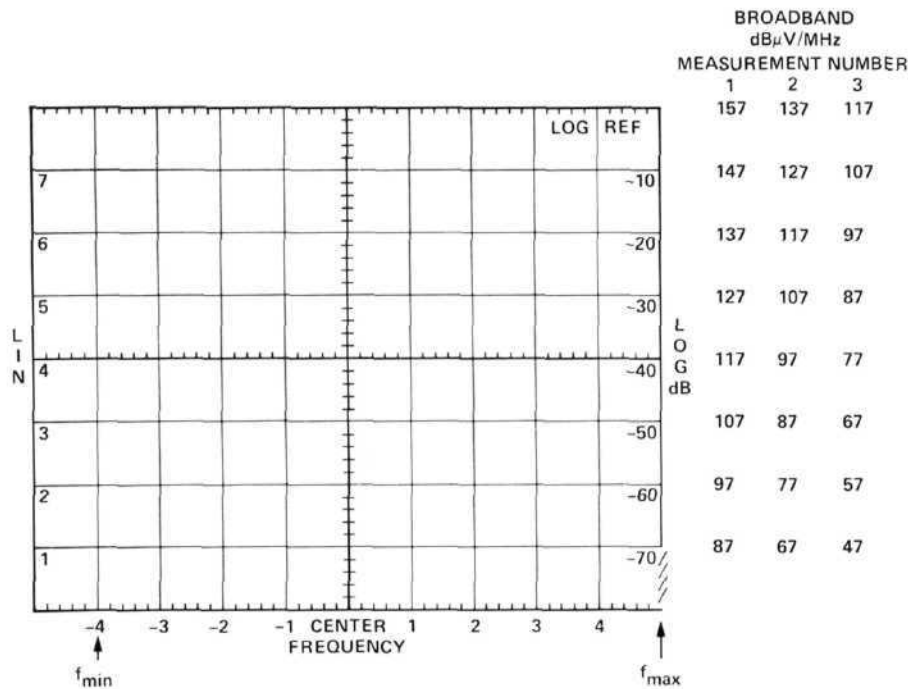

Figure 13B.

13.3.2 20 MHz to 200 MHz. In this range, use the following equipment:

Model 8554L Tuning Section

Model 3104 Antenna

Frequency Range fmin = 20 MHz/fmax = 200 MHz
 Bandwidth 100 kHz
 Scan Width 20 MHz/Div
 Center Frequency 100 MHz
 Log Ref Level 60 dB μ V

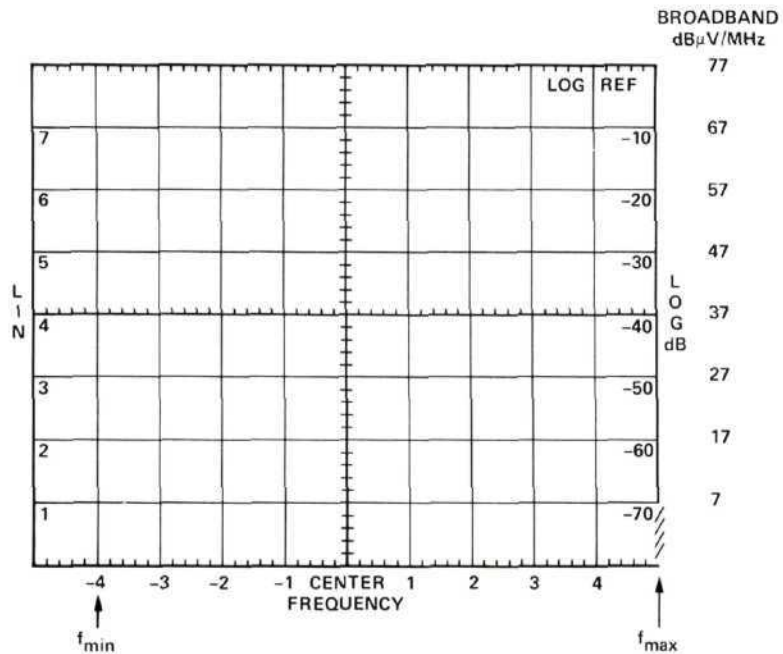

Figure 13C.

13.3.3 200 MHz to 1 GHz. In this range, use the following equipment:

Model 8554L Tuning Section

Model 3101 Antenna

Frequency Range $f_{min} = 200 \text{ MHz}/f_{max} = 1 \text{ GHz}$
 Bandwidth 100 kHz
 Scan Width 100 MHz/Div
 Center Frequency 500 MHz
 Log Ref Level 60 dB μ V

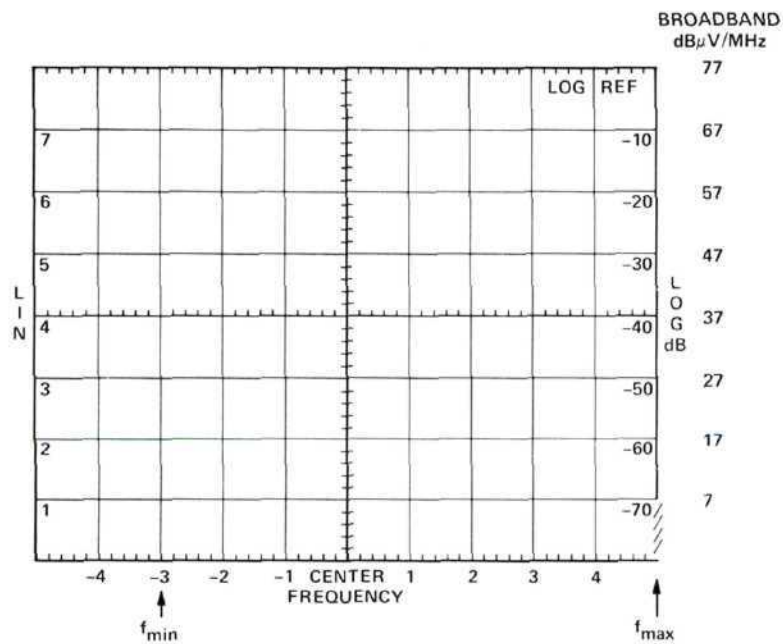

Figure 13D.

13.4 Calibrating and Marking Display

Frequency	MIL-STD-461 Limits Broadband (dB μ V/m/MHz)	Antenna Factor (dB/m)	Spectrum Analyzer Input Level = Spec Limit - Antenna Factor (dB μ V/MHz)
14 kHz	148	0	148
20 kHz	145	0	145
50 kHz	136	0	136
80 kHz	132	0	132
100 kHz	130	0	130
500 kHz	115	0	115
1 MHz	109	0	109
2 MHz	102	0	102
10 MHz	88	0	88
20 MHz	82	0	82
20 MHz	82	11.5	70.5
25 MHz	80	11.7	68.3
30 MHz	80	12	68
40 MHz	80	13.5	66.5
50 MHz	80	12.5	67.5
60 MHz	80	8.5	71.5
70 MHz	80	7	73
80 MHz	80	8	72
90 MHz	80	12	68
100 MHz	80	14	66
120 MHz	80	16	64
130 MHz	80	15	65
150 MHz	80	16	64
180 MHz	80	19	61
200 MHz	80	19	61
200 MHz	80	25.5	54.5
250 MHz	80	21.5	58.5
300 MHz	80	18.5	61.5
400 MHz	80	19	61
500 MHz	80	20	60
600 MHz	80	22	58
800 MHz	80	24.5	55.5
1 GHz	80	27	53

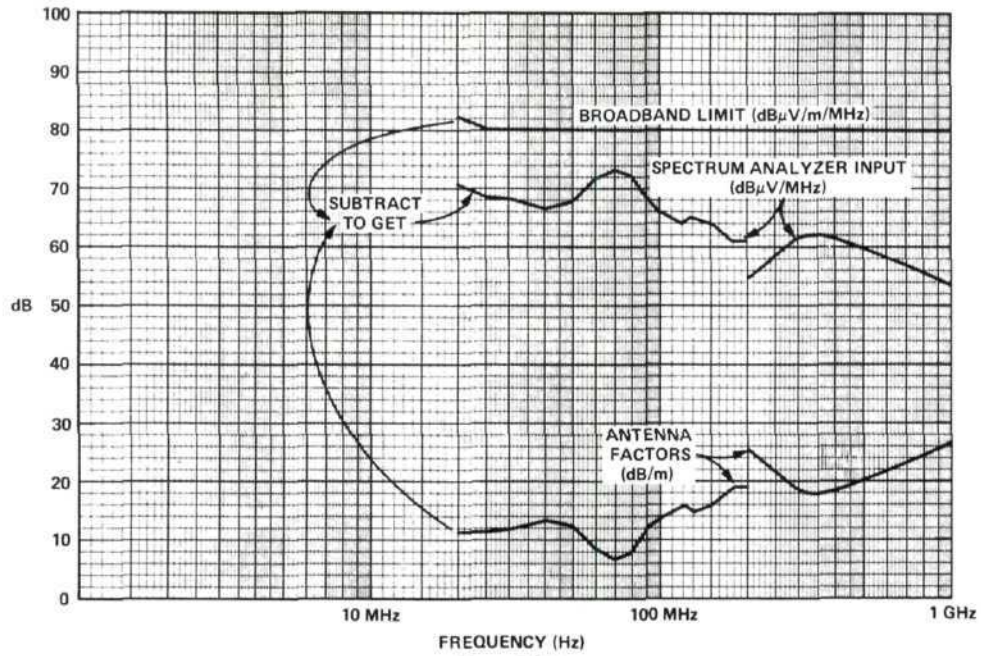

Figure 13E.

Subtract antenna factor (dB/m) of your antenna from MIL-STD limits in $\text{dB}\mu\text{V}/\text{m}/\text{MHz}$ to obtain spectrum analyzer input signal level in $\text{dB}\mu\text{V}/\text{MHz}$. See tables and curves above.

Then copy the values obtained onto the spectrum analyzer display. See the following examples.

EXAMPLES

14 kHz to 100 kHz

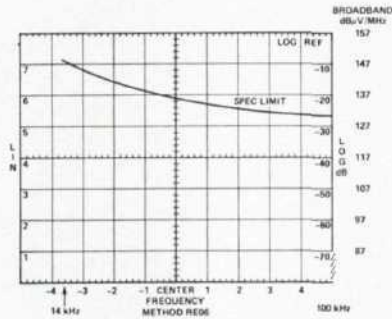

Figure 13F.

100 kHz to 1 MHz

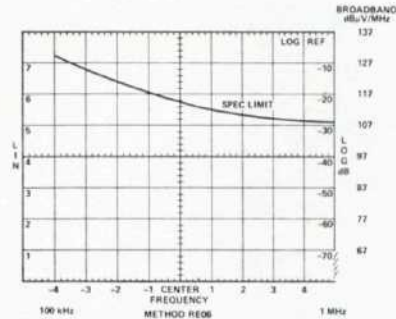

Figure 13G.

Broadband signal level calibration is obtained by subtracting Bandwidth Figure B from the dB μ V calibration obtained from control settings in Section 13.3.1.

Example: $100 \text{ dB}\mu\text{V} - (-57 \text{ dBMHz}) = +157 \text{ dB}\mu\text{V/MHz}$

NOTE: The exact labeling of the broadband scale depends on the actual bandwidth of your analyzer and should be measured beforehand.

1 MHz to 20 MHz

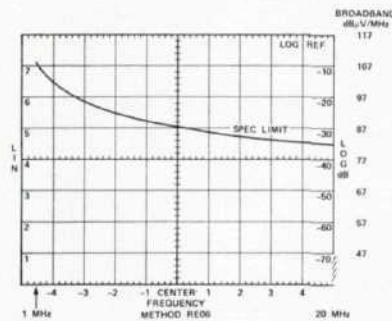

Figure 13H.

20 MHz to 200 MHz

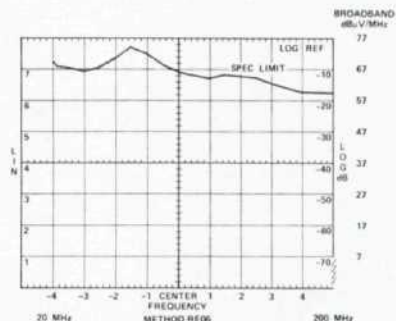

Figure 13I.

Broadband limits are copied from the table or curves. Label frequency scale as shown in Section 13.3.

200 MHz to 1 GHz

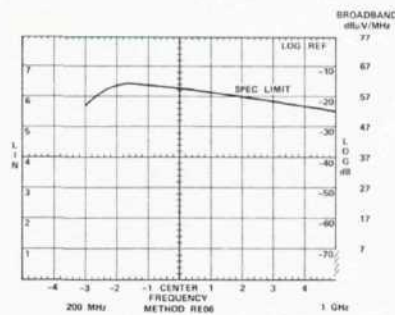

Figure 13J.

Specification limits, frequencies, and method number may be marked directly on CRT or an overlay may be used. A photo of the spectrum will then contain all information.

13.5 Frequency Calibration

Set all controls as shown in Section 13.3. With no signal input, use the FREQUENCY control to bring the L0 feedthrough signal to the left edge of the CRT.

13.6 Precautions

For each frequency range, start with the spectrum analyzer in the full scan mode and the step attenuator set to 60 dB. Decrease the attenuation in 10 dB steps while observing the display. Continue removing attenuation until some signals do not behave linearly (i.e., they do not increase in 10 dB steps) or until 0 dB is reached. Use the least amount of attenuation which allows linear behavior while making the measurement. (Be sure to account for the attenuator setting when calculating the signal level.)

13.7 Signal Identification

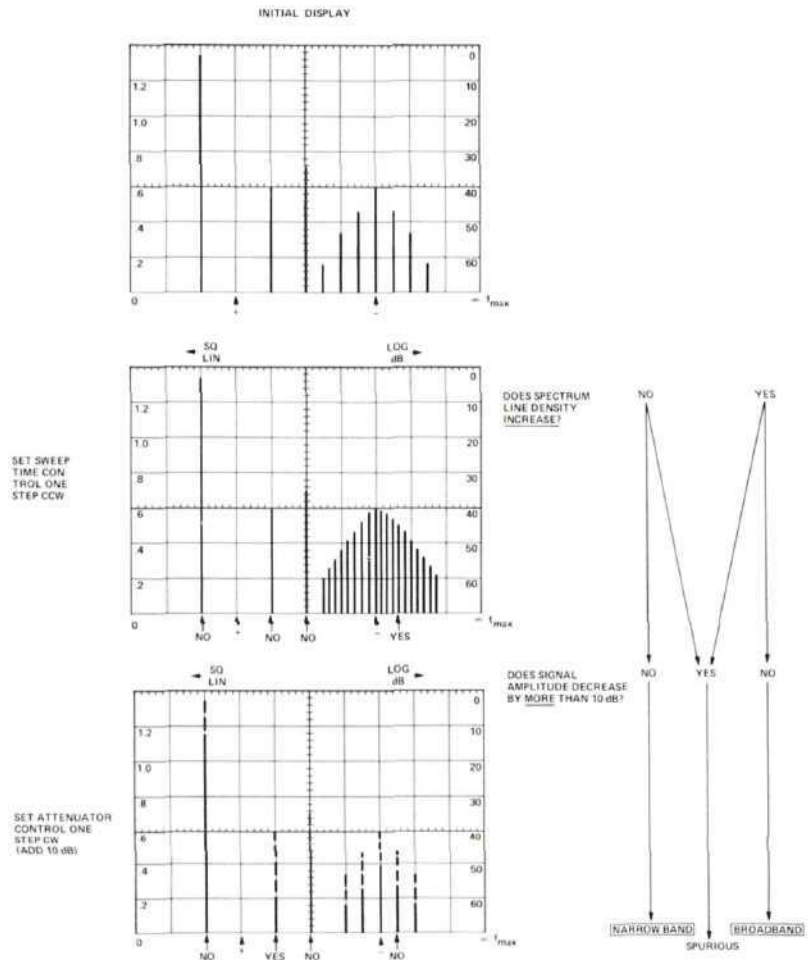

14. METHOD RS01, RADIATED SUSCEPTIBILITY, 30 Hz TO 30 kHz, MAGNETIC FIELD

The objective of this method is to determine the susceptibility of a test device to radiated magnetic fields.

14.1 Instruments and Accessories Used

Spectrum Analyzer Tuning Section, Model 8556A Option H11
 Spectrum Analyzer IF Section, Model 8552B Option H04
 Spectrum Analyzer Display Section, Model 141T
 Oscillator, Model 200AB
 Resistor, 1 ohm, 2W
 Loop Radiator per MIL-STD-461

14.2 Test Setup

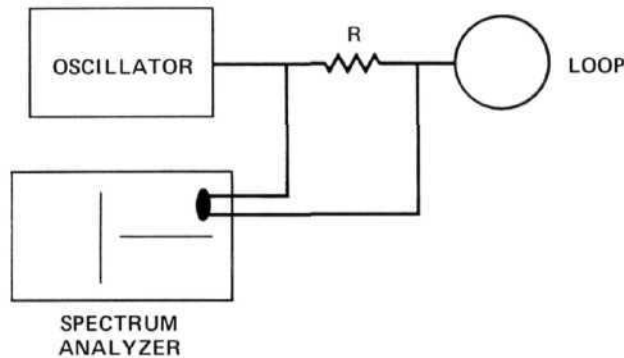

Figure 14A. Test setup for Method RS01. (Note: Spectrum Analyzer to be used unterminated as a high impedance voltmeter.)

14.3 Control Settings and CRT Calibration

The spectrum analyzer will be used as a monitor of the signal level to the radiating loop.

Although individual requirements will vary, the following information will assume certain conditions as an example. See MIL-STD-462 for more complete information. Assumed Conditions:

Test sample bandwidth <10 Hz
 Output adjusted for 6 dB S/N ratio

Measurement Number	Frequency Range		Scan Width	Center Frequency	Bandwidth	Log Ref Level
	fmin	fmax				
1	0*	200 Hz	20 Hz/Div	(0-10f)	10 Hz	120 dB μ V
2	0**	2 kHz	200 Hz/Div	(0-10f)	10 Hz	90 dB μ V
3	0***	5 kHz	500 Hz/Div	2.5 kHz	10 Hz	50 dB μ V
4	5 kHz	10 kHz	500 Hz/Div	7.5 kHz	10 Hz	30 dB μ V
5	10 kHz	15 kHz	500 Hz/Div	12.5 kHz	10 Hz	30 dB μ V
6	15 kHz	20 kHz	500 Hz/Div	17.5 kHz	10 Hz	30 dB μ V
7	20 kHz	25 kHz	500 Hz/Div	22.5 kHz	10 Hz	30 dB μ V
8	25 kHz	30 kHz	500 Hz/Div	27.5 kHz	10 Hz	30 dB μ V

*Measure from 30 Hz
 **Measure from 200 Hz
 ***Measure from 2 kHz

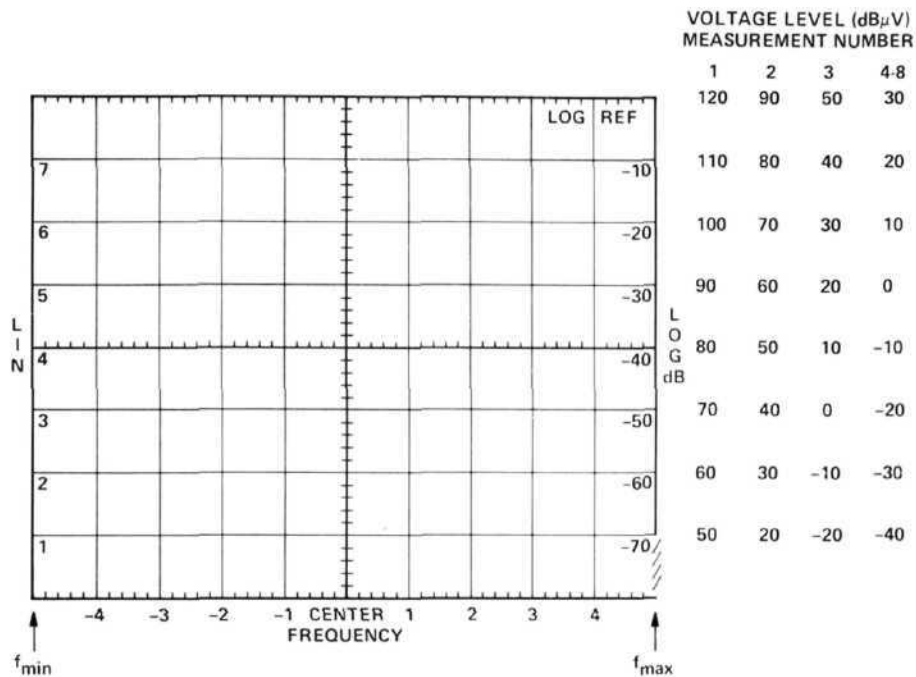

Figure 14B.

14.4 Calibrating and Marking Display

A constant correction factor will be added to the spectrum analyzer level to obtain the flux density in dBpT referred to a 1 Hz bandwidth.

Since the current through a 1 Ω resistor is numerically equal to the voltage across it, we don't need to correct for the current reading.

To convert from voltage to flux density, then, the relationship $B = 5 \times 10^{-5}$ TESLA/AMP can be used. This yields 0 dBpT = -34 dB μ V.

Then, to account for the 10 Hz bandwidth of the spectrum analyzer, we must subtract 10 dB from the reading to get dBpT/Hz.

Therefore, $\text{dBpT/Hz} = \text{dB}\mu\text{V} + 34 \text{ dBpT}/\mu\text{V} - 10 \text{ dB/Hz}$ or $\text{dBpT/Hz} = \text{dB}\mu\text{V} + 24 \text{ dBpT}/\mu\text{V/Hz}$

This will calibrate our CRT scale, and it will also allow us to mark the specification limits on the CRT.

Spectrum Analyzer Input Level = Spec Limit -24 dB.

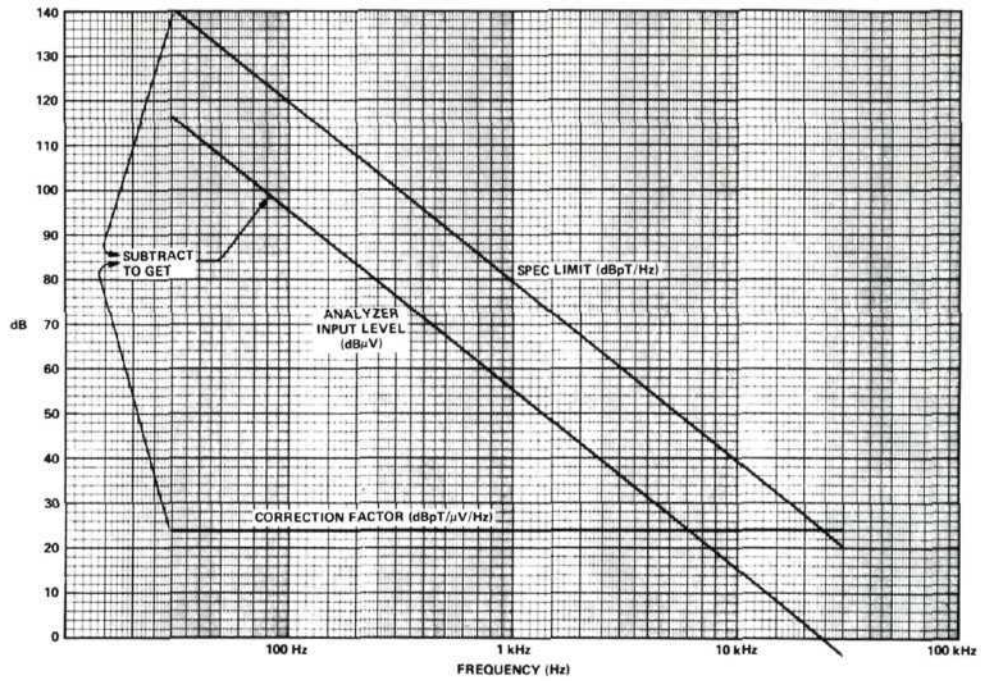

Figure 14C.

Transfer the curve from Figure 14C to the spectrum analyzer CRT. This will indicate the maximum level for a 6 dB S/N ratio on the test device.

EXAMPLES

30 Hz to 200 Hz

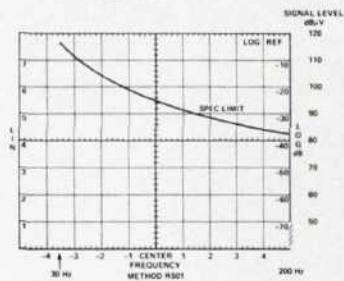

Figure 14D.

200 Hz to 2 kHz

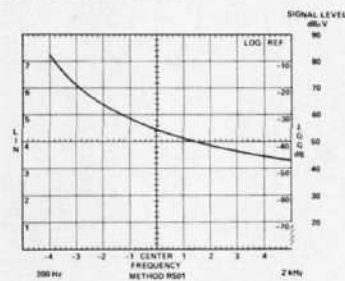

Figure 14E.

2 kHz to 5 kHz

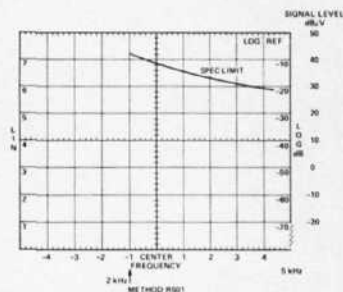

Figure 14F.

5 kHz to 10 kHz

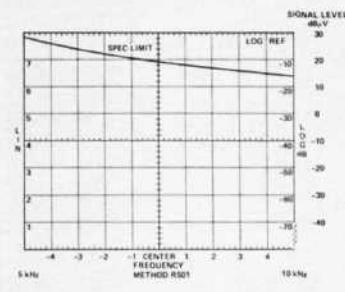

Figure 14G.

10 kHz to 15 kHz

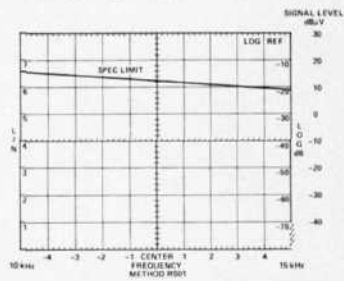

Figure 14H.

15 kHz to 20 kHz

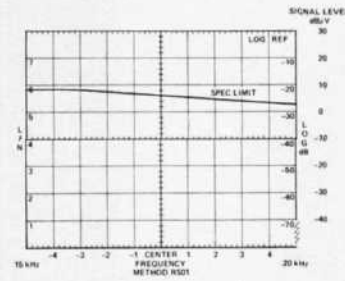

Figure 14I.

20 kHz to 25 kHz

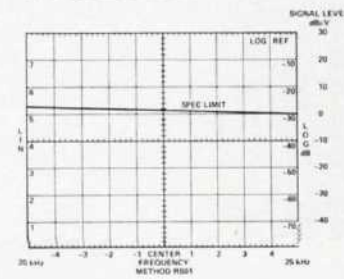

Figure 14J.

25 kHz to 30 kHz

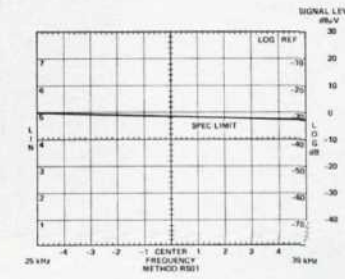

Figure 14K.

14.5 Frequency Calibration

Set all controls as shown in Section 14.3. For measurements 1-3, start with no signal input and adjust the ZERO ADJ to bring the LO feedthrough signal to the left edge of the CRT. For measurements 4-8, use the calibration of the frequency dial.

14.6 Precautions

Start each measurement with the oscillator at low power and increase slowly to the desired level to avoid inadvertent overload of the spectrum analyzer.

14.7 Signal Identification

Does not apply.

15. METHOD RS03, RADIATED SUSCEPTIBILITY, 14 kHz TO 10 GHz, ELECTRIC FIELD

The objective of this method is to ensure that a test sample does not exhibit degradation in performance when subjected to an electric field.

15.1 Instruments and Accessories Used

Spectrum Analyzer Tuning Section, Model 8553B
Spectrum Analyzer Tuning Section, Model 8555A
Spectrum Analyzer IF Section, Model 8552B Option H04
Spectrum Analyzer Display Section, Model 141T
Automatic Preselector, Model 8445A

Receiving Antennas

Rod Antenna, Singer, Model VR-1-105, or equivalent
Rod Antenna, Singer, Model VA-105, or equivalent
Biconical Antenna, EMCO, Model 3104, or equivalent
Log Spiral Antenna, EMCO, Model 3101, or equivalent
Log Spiral Antenna, EMCO, Model 3102, or equivalent

Transmitting Antennas

Rod Antenna, Singer, Model VR-1-105, or equivalent
Rod Antenna, Singer, Model VA-105, or equivalent
Biconical Antenna, EMCO, Model 3104, or equivalent
Log Spiral Antenna, EMCO, Model 3101, or equivalent
Log Spiral Antenna, EMCO, Model 3102, or equivalent
Test Oscillator, Model 651B
Signal Generator, Model 608E
Signal Generator, Model 612A
Signal Generator, Model 8614A
Signal Generator, Model 8616A
Signal Generator, Model 618C
Signal Generator, Model 620B
Amplifier, Instruments for Industry Model M5000L, or equivalent
Amplifier, 200–1000 MHz (to be determined)
Amplifier, Model 489A
Amplifier, Model 491A
Amplifier, Model 493A
Amplifier, Model 495A
Frequency Counter, Model 5340A

15.2 Test Setup

The test setup shall be as required by MIL-STD-462 for the placement of antennas. For calibration purposes, the receiving antenna will be placed in the location where the test sample will be during testing.

15.3 Control Settings and CRT Calibration

Measurement Number	Tuning Section	Antenna ¹	Scan Width	Center Frequency	Measurement Frequency Range		Band	Log Ref Level
					fmin	fmax		
1	8553B	#1	20 kHz/Div	100 kHz	14 kHz	150 kHz	—	120 dB μ V
2	8553B	#2	100 kHz/Div	500 kHz	150 kHz	1 MHz	—	120 dB μ V
3	8553B	#2	2 MHz/Div	10 MHz	1 MHz	20 MHz	—	120 dB μ V
4	8555A	#3	20 MHz/Div	100 MHz	20 MHz	200 MHz	0.01–2.05	120 dB μ V
5	8555A	#4	100 MHz/Div	500 MHz	200 MHz	1 GHz	0.01–2.05	120 dB μ V
6	8555A	#5	100 MHz/Div	1.5 GHz	1 GHz	1.8 GHz	0.01–2.05	120 dB μ V
7	8555A	#5	20 MHz/Div	1.9 GHz	1.8 GHz	2.0 GHz	1.50–3.55	120 dB μ V
8	8555A	#5	100 MHz/Div	2.5 GHz	2.0 GHz	3.0 GHz	1.50–3.55	120 dB μ V
9	8555A	#5	100 MHz/Div	3.5 GHz	3.0 GHz	4.0 GHz	2.60–4.65	120 dB μ V
10	8555A	#5	200 MHz/Div	5 GHz	4.0 GHz	6.0 GHz	2.07–6.15	120 dB μ V
11	8555A	#5	200 MHz/Div	7 GHz	6.0 GHz	8.0 GHz	4.13–10.25	120 dB μ V
12	8555A	#5	200 MHz/Div	9 GHz	8.0 GHz	10.0 GHz	6.17–10.25	120 dB μ V

¹Antennas
 No. 1 – Model VR-1-105
 No. 2 – Model VA-105
 No. 3 – Model 3104
 No. 4 – Model 3101
 No. 5 – Model 3102

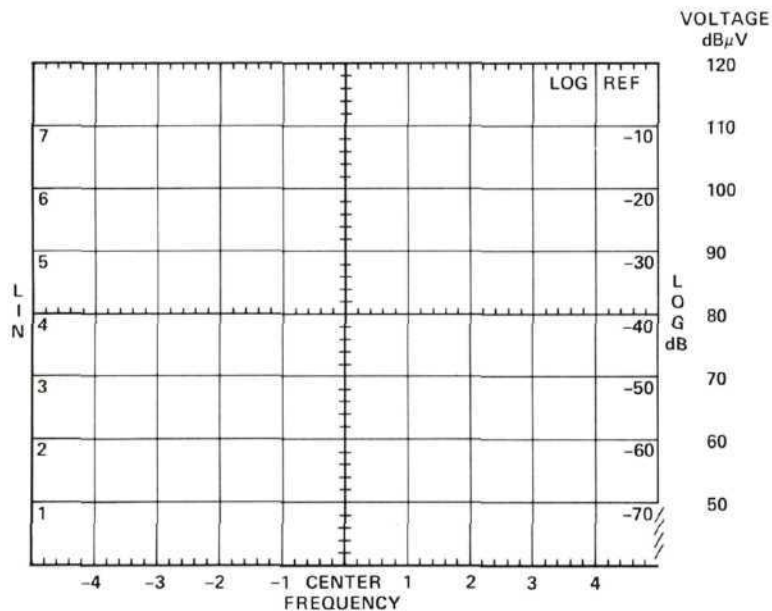

Figure 15A.

15.4 Calibrating and Marking Display and Measurement Procedure

- a. Copy specification limits from MIL-STD-461.
- b. Copy antenna factors supplied with your antennas.
- c. Subtract antenna factors (in dB) from specification limits at as many frequencies as required to get a detailed curve. This is the input voltage to the spectrum analyzer for the specified field strength.
- d. Record the values obtained in c.
- e. Mark the curves obtained on your spectrum analyzer display (as shown in examples for Method RE02). Your analyzer is now calibrated for the required field strength.
- f. Connect the calibrated antenna of the proper frequency range to the spectrum analyzer, and place the antenna where the test sample will be placed.
- g. Adjust signal generator output level until the displayed signal reaches the marked curve on the spectrum analyzer.
- h. Read and record attenuator setting on the signal generator.
- i. Repeat procedure until whole frequency range is covered.
- j. Replace calibrated antenna by test sample.
- k. Follow procedure in MIL-STD-462. Set output attenuator on signal generator to values recorded in step h.

15.5 Frequency Calibration

Use the Model 5340A Frequency Counter to record the frequency of the signal generator for each point to be tested.

15.6 Precautions

Always use at least 20 dB of input attenuation on the spectrum analyzer. Start each measurement from a low signal level, slowly increasing to the specification to avoid overloading the spectrum analyzer input.

15.7 Signal Identification

Does not apply.

16. METHOD RS04, RADIATED SUSCEPTIBILITY, 14 kHz TO 30 MHz

The objective of this method is to determine the susceptibility of a test sample to radiated fields of specified intensity.

16.1 Instruments and Accessories Used

Spectrum Analyzer Tuning Section, Model 8553B
 Spectrum Analyzer IF Section, Model 8552B Option H04
 Spectrum Analyzer Display Section, Model 141T
 Parallel Plate Line per Method RS04
 Matching Pads per Method RS04
 30 MHz Low Pass Filter
 Test Oscillator, Model 651B
 Signal Generator, Model 608E
 Amplifier, Instruments for Industry, Model M5000L, or equivalent

16.2 Test Setup

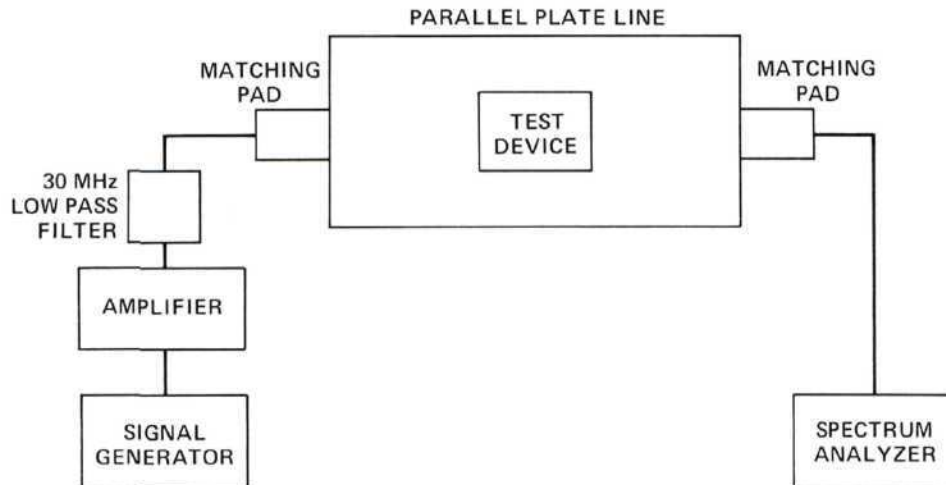

Figure 16A. Test setup for Method RS04.

16.3 Control Settings and CRT Calibration

Measurement Number	Frequency Range	Scan Width	Center Frequency	Bandwidth	Log Ref Level
1	14 kHz—500 kHz	50 kHz/Div	250 kHz	3 kHz	120 dB μ V
2	500 kHz— 30 MHz	5 MHz/Div	25 MHz	30 kHz	120 dB μ V

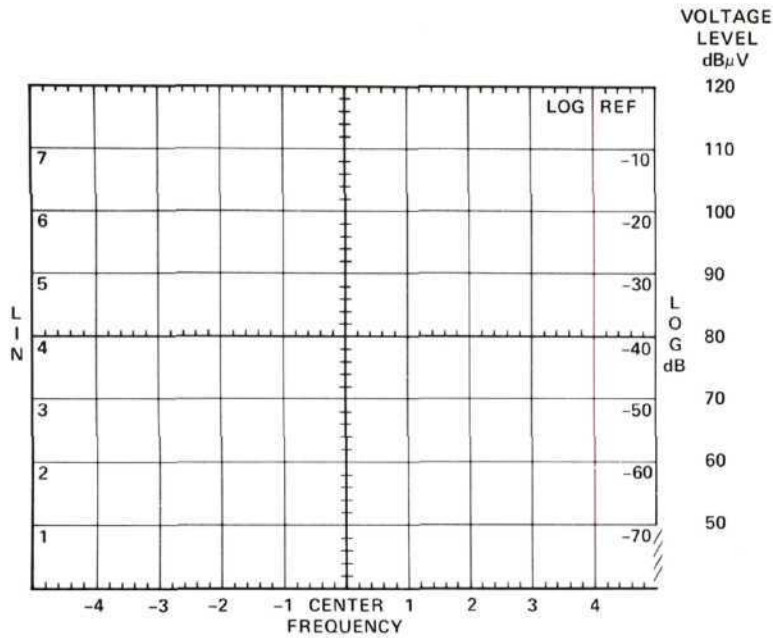

Figure 16B.

16.4 Calibrating and Marking Display and Measurement Procedure

NOTE: Examples will be given for 1V/m field intensity.

- Using Figure RS04-4, we determine that 1V/m equals 0.45V corrected spectrum analyzer reading.
- $0.45V = +113 \text{ dB}\mu\text{V}$, then, subtracting 30 dB for the loss in the pad, the spectrum analyzer input voltage is +83 dB μV .
- Adjust signal generator output until a level of +83 dB μV is indicated on the spectrum analyzer.
- Note any degradation of test device performance.
- Continue steps c and d for entire frequency range.

16.5 Frequency Calibration

An external frequency counter may be used if high frequency accuracy is required. However, dial accuracy of the signal generators should suffice.

16.6 Precautions

Start with signal generator set for a low power output and slowly increase to desired level to avoid overloading the spectrum analyzer input.

16.7 Signal Identification

Does not apply.

APPENDIX A
MEASUREMENT OF IMPULSE BANDWIDTH

NOMENCLATURE

BW_2	Impulse bandwidth of a preselector filter
BW_i	Impulse bandwidth
f_L	Frequency width of main lobe of frequency spectrum
f_o	Signal generator frequency delivered to PIN modulator; center frequency of frequency spectrum
f_r	Pulse repetition frequency = $1/T$
S	Spectral intensity of an impulse signal in rms volts/MHz
T	Time between two pulses
V_1	rms voltage of pulse signal during "on" time
V_2	rms voltage of single frequency line of impulse spectrum
V_p	Peak value of voltage transient (in rms volts) at the output of a lossless filter having an impulse bandwidth, BW_i , caused by an impulse signal at the input
V_{p1}, V_{p2}	Peak value of voltage transients (in volt peak) at the input mixer created by a dc or RF pulse, respectively
V_{out}	Voltage maximum of the frequency spectrum main lobe measured by the spectrum analyzer in rms volts
Δf	$1/\tau$; difference between frequency f_o and frequency of adjacent zero of spectrum
τ	Half peak width of RF pulses; $1/\Delta f$
τ_{eff}	Width of a hypothetical rectangular pulse of the same height (V_1) and same as the actual pulse

DEFINITION OF IMPULSE BANDWIDTH

Impulse signals of short duration having a frequency spectrum that far exceeds the bandwidth of a calibrated voltmeter and having a repetition frequency substantially less than the voltmeter bandwidth are termed broadband impulse signals. They are measured in terms of their spectral intensity in volts per megahertz or dB above one microvolt per megahertz.

Impulse signals cause transient responses in a voltmeter of limited bandwidth. The peak value of these responses is proportional to the spectral intensity of the impulse signal and to the bandwidth of the voltmeter — the exact value of this voltmeter bandwidth has to be known in order to measure the broadband impulse signals. It has been named the “impulse bandwidth”. Unlike the 3-dB bandwidth, its value cannot be found easily from CW response measurements because the transient behavior depends on *the exact shape of the frequency response, on the design of the bandpass, or, if logarithmic amplifiers are used, on the gain-shaping performance.*

Impulse bandwidth (BW_i) is specified as the ratio of the peak value of the voltmeter transient (V_p) divided by the spectral intensity of the impulse signal (S) causing it:

$$BW_i = \frac{V_p}{S} \quad (1)$$

Spectral intensity is specified in rms volts, so V_p must be measured in rms volts; that is, the absolute voltage peak of the transient must be divided by $\sqrt{2}$. This correction is not necessary in usual measurements since substitutions are carried out with CW signals, which are calibrated in rms values.

MEASUREMENT OF IMPULSE BANDWIDTH

Impulse bandwidth can be measured directly only by using calibrated impulse signal sources and Equation (1). Mechanical line-discharge type impulse calibrators can be used with certain reservations for determining the impulse bandwidth of the spectrum analyzer. This method tends to overload the analyzer front end even with using the 8445 Preselector or is limited in dynamic range, therefore, another technique is explained in the following paragraphs.

USE OF PIN MODULATOR TO GENERATE SIGNAL OF KNOWN SPECTRAL INTENSITY

An impulse signal of accurately known spectral intensity can be generated by using a CW signal generator and a PIN modulator (HP series 8730) built into an HP 8403 Modulator:

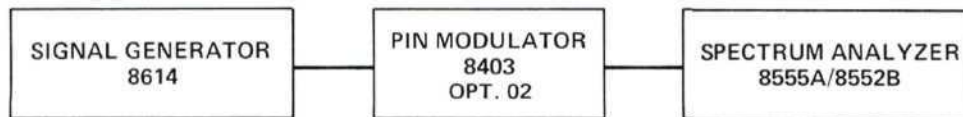

Figure A-1

The PIN modulator is operated between its "on" and "off" state either by dc or by impulses. The amplitude of the signal generator CW signal leaving the PIN modulator during the "on" condition is independent of PIN modulator pulse modulation frequency or pulse width.

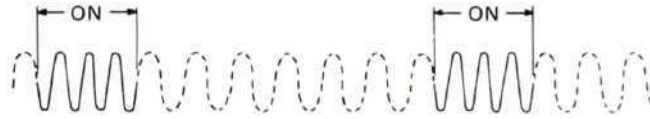

Figure A-2

The PIN modulator, however, possesses finite rise and fall times, so, in general, the signal at its output has the following shape.

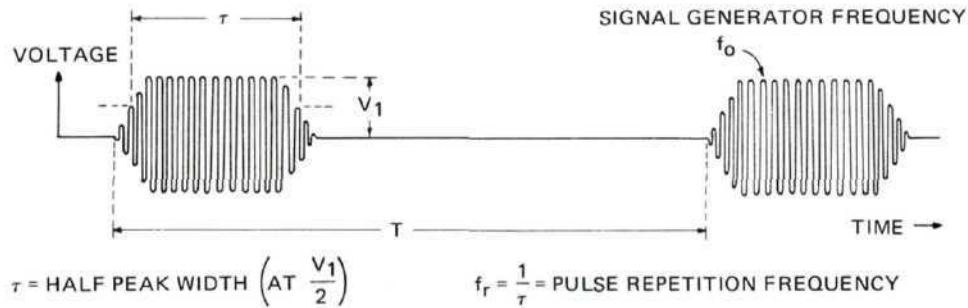

Figure A-3

The frequency spectrum of the impulse shown consists of discrete frequencies at f_0 , $f_0 + f_r$, $f_0 - f_r$, $f_0 + 2f_r$, $f_0 - 2f_r$, etc., or, in general,

$$f_n = f_0 \pm n f_r. \quad (2)$$

(See Figure A-4.)

The voltage of the frequency f_0 is

$$V_{f_0} = V_1 \frac{\tau_{\text{eff}}}{T} = V_1 \tau_{\text{eff}} \cdot f_r = V_1 \cdot \frac{f_r}{\Delta f} \cdot \frac{\tau_{\text{eff}}}{\tau} \quad (3)$$

$\tau_{\text{eff}} = \tau$ for the 8403 PIN Modulator for all practical purposes. This can be verified by measuring V_{f_0} directly using a bandwidth much narrower than the pulse repetition frequency f_r . Equation (3) then yields

$$\frac{\tau_{\text{eff}}}{\tau} = \frac{V_{f_0}}{V_1} \cdot \frac{\Delta f}{f_r} \quad (4)$$

Use Equation (4) to check the performance of the PIN modulator before making the impulse bandwidth measurement. For a properly working instrument, Equation (4) will yield

$$\frac{\tau_{\text{eff}}}{\tau} = 1.$$

The spectrum of the impulse is shown in Figure A-4. Its shape is determined by pulse width τ and the shape of the impulse in the time domain presentation. The half-peak pulse width determines the zeros of the frequency spectrum. Hence, measurement of frequency distance $2\Delta f$ between the two zeros adjacent to signal generator frequency f_0 gives an accurate measure for impulse width (see Figure 4-A); $\tau = 1/(\Delta f)$.

For measurement of the impulse bandwidth, spectral intensity must be constant over the range of this bandwidth. Therefore, it is necessary to choose the impulse width narrow enough so that the flat portion extends well over the range of the bandwidth to be measured. On the other hand, it is desirable to make the spectral intensity as high as possible by making the impulse width as wide as possible.

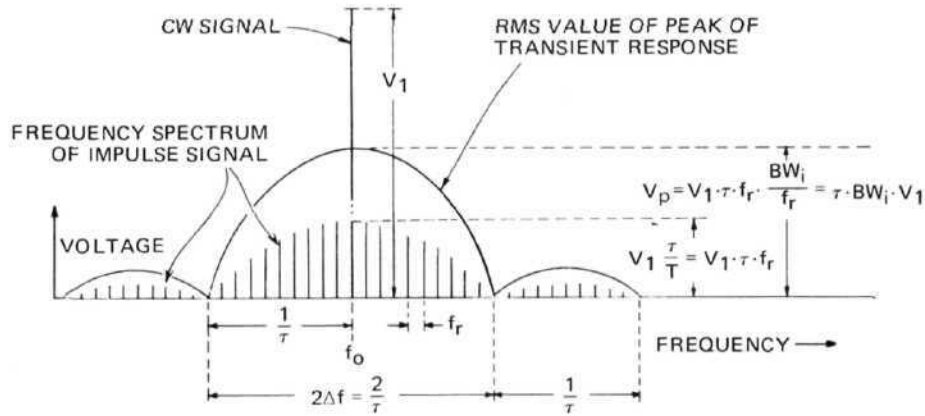

Figure A-4

Since the exact shape of the spectrum depends on the exact shape of the impulse, which is not entirely known at short impulse widths (0.2 μ s) because of rise and fall times in the order of 20 to 40 ns, the spectrum for the worst case should be considered. The worst case spectrum is given for a triangular pulse shape. For this, frequency $f_0 + n f_r$ or frequency $f_0 - n f_r$ will have the following voltage:

$$V_2 = V(f_0 \pm n f_r) = V_1 \cdot \tau \cdot f_r \cdot \left[\frac{\sin(\pi \cdot \tau \cdot n \cdot f_r)}{\pi \cdot \tau \cdot n \cdot f_r} \right]^2 \quad (5)$$

Normally, as frequencies outside twice the 3-dB bandwidth have very little effect on the peak voltage of the transient response of the voltmeter, it is sufficient to keep this portion flat. If we choose

$$\frac{1}{\tau} = 10 \text{ BW}_{3\text{dB}} \quad (6)$$

it follows from Equation (5) that a relative drop, a , in spectral line voltage between frequencies f_0 and $f_0 \pm (0.1/\tau)$ will be:

$$a_{\text{tri}} = 0.29 \text{ dB (This is the flatness of response for a triangular impulse over twice the 3-dB bandwidth.)} \quad (7)$$

$$a_{\text{rect}} = 0.14 \text{ dB (This is the flatness of response for a rectangular impulse over twice the 3-dB bandwidth.)} \quad (8)$$

VOLTMETER TRANSIENT

The voltage peak of the voltmeter transient is the summation of the voltages of all the spectral lines within the bandwidth of the voltmeter. Due to the non-linear phase-versus-frequency characteristic of bandpass filters around the stop-pass-band boundaries, this summation has to take phase (or delay) distortion into account. That is why it is difficult to determine the impulse bandwidth from measured frequency response alone. With a frequency spectrum extending well over the range of the bandwidth and consisting of discrete frequencies spaced at a distance of f_r apart and having the same voltage V_2 , the peak of the transient response of the voltmeter becomes

$$V_p = V_2 \cdot m \quad (9)$$

where

$$m = \frac{BW_i}{f_r} = \text{number of spectral lines within the impulse bandwidth } BW_i. \quad (10)$$

Substituting Equation (10), we get

$$V_p = V_2 \cdot \frac{BW_i}{f_r} \quad (11)$$

and, with

$$V_2 = V_1 \cdot \tau \cdot f_r, \quad (12)$$

Equation (9) now becomes

$$V_p = V_1 \cdot \tau \cdot f_r \cdot \frac{BW_i}{f_r} = V_1 \cdot \tau \cdot BW_i. \quad (13)$$

Impulse bandwidth is

$$BW_i = \frac{V_p}{V_1} \cdot \frac{1}{\tau}; \quad (14)$$

and spectral intensity is

$$S = \frac{V_2}{f_r} = \frac{V_1 \cdot \tau \cdot f_r}{f_r} = V_1 \cdot \tau. \quad (15)$$

(V_1 = rms volts of CW signal)

APPENDIX B
MAXIMUM BROADBAND SIGNAL LIMITATIONS

MAXIMUM BROADBAND SIGNAL THAT CAN BE MEASURED WITHOUT FRONT END OVERLOAD

Impulse signals of the form shown in Figure B-1 can overload the spectrum analyzer front end while the displayed signal at the CRT is far below full scale. The frequency spectrum of both these signals has the general form shown in Figure B-2.

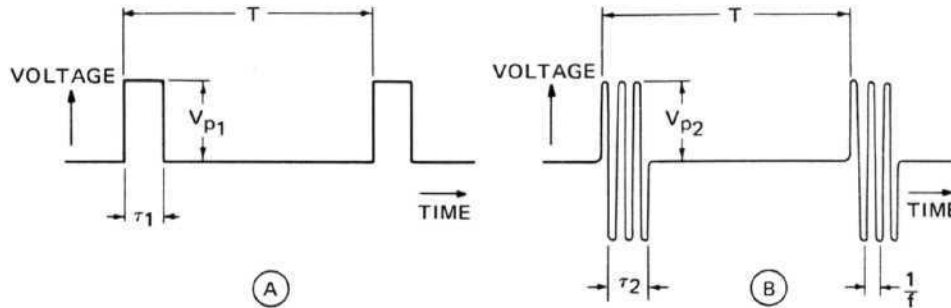

Figure B-1

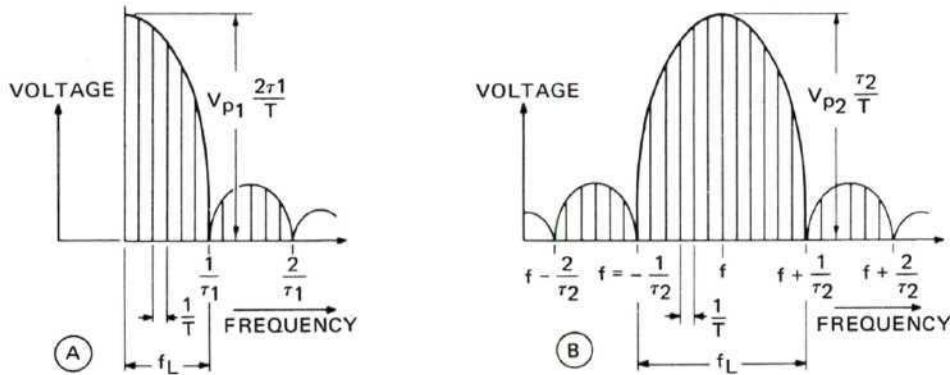

Figure B-2

The maximum spectral intensity is

for Figures B-1A, B-2A

$$S_{\text{rms}} = \frac{V_{p1} \cdot \tau_1 \cdot 2}{T} \cdot \frac{T}{\sqrt{2}} = \sqrt{2} V_{p1} \cdot \tau_1 = \sqrt{2} \frac{V_{p1}}{f_L} \quad (16)$$

for Figures B-1B, B-2B

$$S_{\text{rms}} = \frac{V_{p2} \cdot \tau_2}{T} \cdot \frac{T}{\sqrt{2}} = \frac{V_{p2} \cdot \tau_2}{\sqrt{2}} = \sqrt{2} \frac{V_{p2}}{f_L} \quad (17)$$

Because of the broadband input of the spectrum analyzer, the signal appears at the input mixer as shown in Figure B-1. The signal displayed at the CRT, however, appears as

$$V_{\text{out rms}} = S_{\text{rms}} \cdot BW_i = \frac{V_p \cdot \sqrt{2} \cdot BW_i}{f_L} \quad (18)$$

Therefore, when using a narrow IF bandwidth, the impulse bandwidth BW_i is narrow and the displayed voltage small.

The input voltage V_p necessary to overload the front end mixer (defined as the point where its conversion loss has increased by 1 dB) is approximately

$$V_{pm} = 0.07V \text{ rms (for each of the tuning sections)}$$

The width of the main lobe, f_L , can be determined from the spectrum analyzer display of the signal. BW_i , the impulse bandwidth for a particular IF bandwidth setting, is known or can be measured using the method given in the calibration section of this application note.

When using logarithmic display and vertical calibration in terms of $\text{dB}\mu\text{V}/\text{MHz}$, the display signal for which overload starts is

$$S_{rms} = 20 \log \left(\frac{V_{pm}}{1 \mu\text{V}} \cdot \sqrt{2} \cdot \frac{1 \text{ MHz}}{f_L} \right). \quad (19)$$

The following table has been calculated from Equation (19).

**MAXIMUM BROADBAND SIGNAL WITH RESPECT TO MIXER OVERLOAD
(ADD INPUT ATTENUATOR SETTING IN dB TO THE VALUES SHOWN)**

Width of Signal Main Lobe f_o	Displayed Signal Maximum $\text{dB}\mu\text{V}/\text{MHz}$
10 kHz	140
100 kHz	120
1 MHz	100
10 MHz	80
100 MHz	60
1000 MHz	40

FRONT END OVERLOAD BY IMPULSE CALIBRATOR

The spectrum of an impulse calibrator usually extends over an extremely wide frequency range. The spectral intensity it delivers is constant over any small portion at the low end of this range. Peak voltage V_p of an impulse calibrator signal of spectral intensity S_{rms} in $\text{V rms}/\text{Hz}$ after passing through a preselector filter with a passband of width BW_2 in Hz is

$$V_{p(\text{peak})} = \sqrt{2} \cdot S_{rms} \cdot BW_2 = V_{rms} \cdot \sqrt{2}. \quad (20)$$

When using logarithmic display and vertical calibration in terms of $\text{dB}\mu\text{V}/\text{MHz}$, the maximum permissible amplitude of an impulse calibrator is

$$S_{rms} = 20 \log \left(\frac{V_{prms}}{1 \mu\text{V}} \cdot \frac{1 \text{ MHz}}{BW_2} \right). \quad (21)$$

The following table has been calculated from Equation (21).

**MAXIMUM BROADBAND SIGNAL FROM AN IMPULSE CALIBRATOR AS
FUNCTION OF PRESELECTOR BANDWIDTH WITH RESPECT TO
FRONT END OVERLOAD**

(ADD RF ATTENUATOR SETTING IN dB TO THE VALUES SHOWN)

Filter (Ahead of Front End (Having An Impulse Bandwidth BW ₂)	Maximum Impulse Calibrator Signal dB μ V/MHz (rms)	
	8553B	8555A
1 MHz	97	97
10 MHz	77	77
30 MHz	67	67
100 MHz	57	57
300 MHz	47	47
1000 MHz	37	37
3 GHz	27	27
10 GHz	17	17

Note 1. 8553B Tuning Section has a low-pass filter of 120-MHz bandwidth ahead of mixer.

2. 8445A Automatic Preselector has a bandwidth of from 20 to 70 MHz.

APPENDIX C
LIST OF SPECTRUM ANALYZER SENSITIVITIES

TABLES OF CW SENSITIVITIES

Broadband sensitivities are not listed. They can be obtained by subtracting the bandwidth factor, B, from the CW sensitivities given in the tables. B is found from the equation:

$$B = 20 \log \frac{\text{Impulse Bandwidth}}{1 \text{ MHz}}$$

Example: Impulse bandwidth is 1 kHz and CW sensitivity is -127 dBm or -20 dB μ V

Then,

Broadband sensitivity is:

$$-127 \text{ dBm} - 20 \log \frac{10^3}{10^6} = -127 + 60 = -67 \text{ dBm/MHz}$$

or

$$-20 \text{ dB}\mu\text{V} - 20 \log \frac{10^3}{10^6} = +40 \text{ dB}\mu\text{V/MHz}$$

Model 8556A Spectrum Analyzer

Frequency	Noise Figure dB	Equivalent Noise Voltage	
		BW = 1 kHz	BW = 10 Hz
20 Hz – 300 kHz	22	-122 dBm -15 dB μ V	-142 dBm -35 dB μ V

Model 8553B Spectrum Analyzer

Frequency	Noise Figure dB	Equivalent Noise Voltage	
		BW = 300 kHz	BW = 10 Hz
1 MHz – 110 MHz	24	-95 dBm +12 dB μ V	-140 dBm -33 dB μ V

Model 8554L Spectrum Analyzer

Frequency	Noise Figure dB	Equivalent Noise Voltage	
		BW = 300 kHz	BW = 300 Hz
1 MHz – 1250 MHz	32	-87 dBm +20 dB μ V	-117 dBm -10 dB μ V

Model 8555A Spectrum Analyzer

NOTE: Does not include Automatic Preselector or low noise amplifiers. The insertion loss of the preselector and gain/noise figure of preamps must be taken into account.

Frequency (GHz) Mixing Mode	Noise Figure dB	Equivalent Noise Voltage	
		BW = 300 kHz	BW = 300 Hz
0.01 – 2.05 1–	29	–90 dBm +17 dB μ V	–120 dBm –13 dB μ V
1.50 – 3.55 1–	27	–92 dBm +15 dB μ V	–122 dBm –15 dB μ V
2.07 – 6.15 2–	36	–83 dBm +24 dB μ V	–113 dBm –6 dB μ V
2.60 – 4.65 1+	27	–92 dBm +15 dB μ V	–122 dBm –15 dB μ V
4.11 – 6.15 1+	49	–90 dBm +17 dB μ V	–120 dBm –13 dB μ V
4.13 – 10.25 3–	41	–78 dBm +29 dB μ V	–108 dBm –1 dB μ V
6.17 – 10.25 2+	39	–80 dBm +27 dB μ V	–110 dBm –3 dB μ V
6.19 – 14.35 4–	49	–70 dBm +37 dB μ V	–100 dBm +7 dB μ V
8.23 – 14.35 3+	44	–75 dBm +32 dB μ V	–105 dBm +2 dB μ V
10.29 – 18.00 4+	54	–65 dBm +42 dB μ V	–95 dBm +12 dB μ V

