

# CQ-DATV

dotMOBI

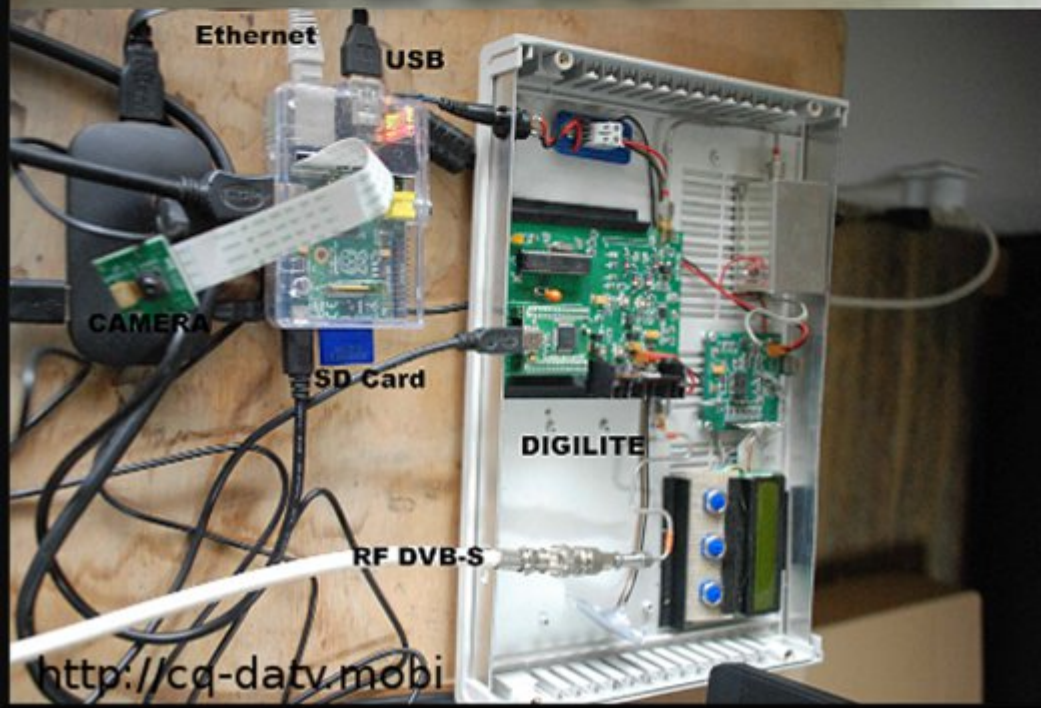

## Issue 19 - January 2015



### In this issue

DATV News.....	2
Editorial.....	7
Reader review comments on DATVtalk11.....	8
Local Oscillator PLL for Digilite project.....	9
DATV-Express Project - November update report.....	14
Using Raspberry PI to feed a DATV modulator.....	16
Moving on with film making - Part 1.....	20
10 GHz SSB with a PLL LNB.....	24
Has USA selected a DATV Protocol yet?.....	28
To PC or not to PC, that is the question.....	29
Information.....	44

### Production Team

Ian Pawson - G8IQU  
Trevor Brown - G8CJS  
Terry Mowles - VK5TM

### Contributing Authors

Fabrizio Bianchi - IW5BDJ  
Trevor Brown - G8CJS  
Evariste - F50EO  
Ken Konechy - W6HHC  
Klaus Kramer - DL4KCK  
Michel Vonlanthen - HB9AFO

### Update on software for ODROID

The DATV-Express project team has "Production Released" v2.03 software for the ODROID model U3 using the Lubuntu v14.04 LTS OS from HardKernel. The ODROID U3 is fairly affordably priced at US\$65 (70 Euro) plus plastic-case, 5V/2A power adapter (wall-wart) and shipping.

Updated README details, a new .DEB download file for ARMhf, and a separate User Guide for ODROID (Draft02) are now all available on the DOWNLOAD page of the DATV-Express web site at: [www.DATV-Express.com](http://www.DATV-Express.com)

Here are four notes to consider if you decide to purchase an ODROID U3 from [www.hardkernel.com/main/main.php](http://www.hardkernel.com/main/main.php) or [www.ameridroid.com](http://www.ameridroid.com) (aimed towards faster USA shipping ):

- 1)Purchase the micro-HDMI adaptor cable when you order the ODROID. They are a little hard to find in some local computer stores.
- 2)Purchase the power-supply (wall wart) from HardKernel that has the thin 2.5 mm 5V DC plug (or at least purchase the plug-with-cable) they are also hard to find.
- 3)Have a HDMI display with 1920x1080 resolution handy for your first power-up and configuration set-up session of the ODROID U3
- 4)If you buy any spare micro-SD memory chips for back-up, use the "class 10" speed.

**73...de Ken W6HHC**

---

## Irish Amateur Television Club

The Irish Amateur Television Club (IATC) welcome visitors to their website, [www.iatc.ie](http://www.iatc.ie)

Should any amateur radio operator have an ATV project they would like to be featured on the IATC website, details of how this can be achieved are available by visiting the above site.

The Dublin ATV repeater is running a test card on 2390.00Mhz. This frequency is just below the 2.4Ghz video senders section.

All reports are welcome and should be sent to Tom, EI7HT at South Dublin Radio Club.

---

### First Live DigiThin Transmission using Raspberry Pi

This is on 437MHz, SR 333k, FEC 3/4, 320 x 240 pixels, 25 frames / sec.

The analyser is set to 10dB / 200kHz per division, resolution bandwidth 10kHz. The analyser gain was adjusted so that the single sideband test with all the power in one carrier was at the top of the screen. I'm not sure if that's cheating, but it does show power levels relative to PEP.

It's pretty close to meeting 60dB down at 500kHz. There are still some distortion products coming out of the digital-analog converter which are causing the widening at the base. I'm hoping to improve that by tweaking the digital filter bandwidth. You still have to amplify it and keep it that narrow of course.

There's still plenty of hardware and software tweaking to do.



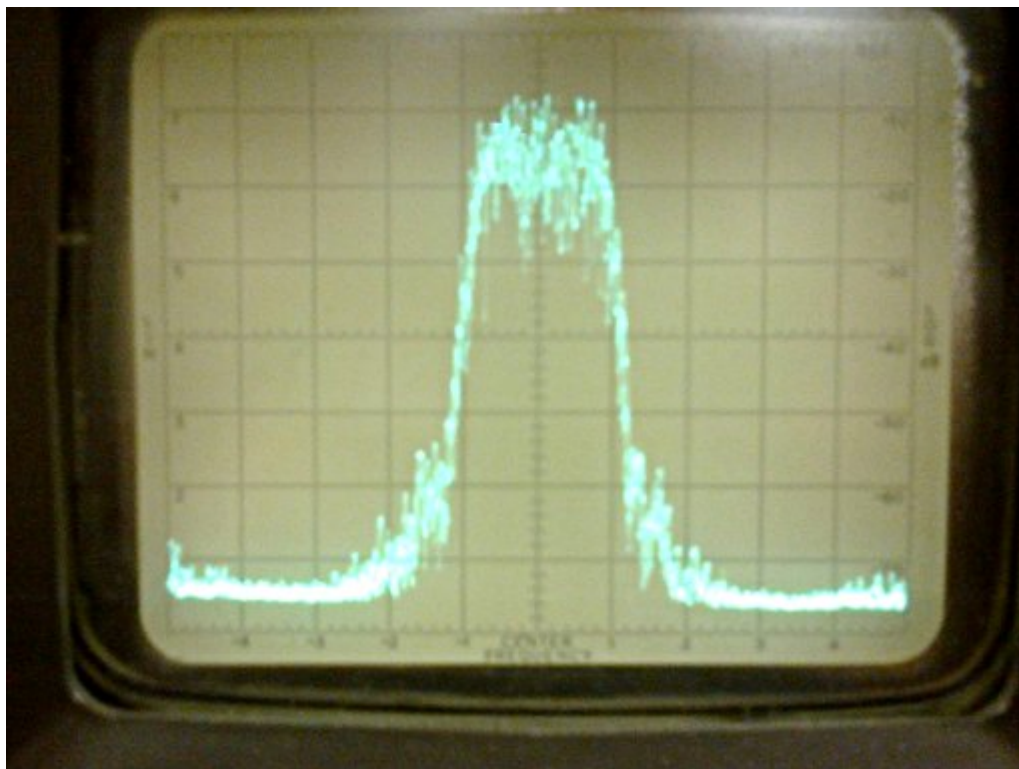

The source of the DAC7801 (not to be confused with the AD7801), which was the only one I could find to do the job, has dried up. There seem to be plenty available at reasonable cost on Alibaba / AliExpress, but I've never bought from there. If anyone has experience in this market and would be willing to help source the chips, please comment here.

**Brian**

---

**John G3RFL reports**

My new RX 23cm hardware controller with buttons. I got sore fingers with rotary pulse tuning. In yet in another nice Hammond box from Maplins.

Oh, I got the cheap (less than £2) white on blue I2C 2 line displays to work and added an auto detect circuit to sort out its address.



---

**Ofcom Amateur Radio Licence Statement**

Ofcom has published a decision to update the terms and conditions of the UK amateur radio licence. Among the changes proposed by Ofcom are:

- Abolition of requirement to ID every 15 minutes
- Addition of a clause which says "The Station must not cause interference to ... electronic equipment"

This follows a consultation published in September. This document is likely to be of interest to individuals authorised to use the radio spectrum in the UK for the purposes of amateur radio activities.

Ofcom Statement:

<http://stakeholders.ofcom.org.uk/con...ence/statement>

PDF which includes new sample licence:

[http://stakeholders.ofcom.org.uk/binaries/consultations/amateur-radio-licence/statement/Updating\\_the\\_Amateur\\_Radio\\_Licence.pdf](http://stakeholders.ofcom.org.uk/binaries/consultations/amateur-radio-licence/statement/Updating_the_Amateur_Radio_Licence.pdf)

Anyone, RSGB member or not, can contribute to the discussion on the forum which is at:

<http://forums.thersgb.org/index.php?forums/ofcom-licence-review/>

When you register on the site there is a question at the bottom which says:

Verification: Who issues amateur radio licences in the UK?

The answer is Ofcom

-----

### Sky high

Stuart M0WTX has just made an aeronautical mobile contact at 40,000ft ASL.

The contact was from a Emirates Airbus A380 on route to Dubai, for those of you that are not part of this Jet set world, all the Emirates Airbus A380 aircraft are equipped with free WI-FI, so Stuart could check into the UK hub of echolink while at 40.000 ft. You can listen to the QSO at

<https://dl.dropboxusercontent.com/u/68150908/Allstar%20at%2040000ft.mp3>. The Wi-Fi is free but you are limited to 10MB or alternatively you can purchase a 500Mb package, which must open the door to an internet DATV connection, all we need are ATV repeaters with an internet input, the voice people are leading the way with echolink and dstar ATV needs to catch up there are world possibilities passing us by. The full details of this Emirates service can be found at

[http://www.emirates.com/ae/english/flying/staying\\_connected/staying\\_connected.aspx](http://www.emirates.com/ae/english/flying/staying_connected/staying_connected.aspx)



-----

### 2 new repeaters licensed!

We have had notification this week of 2 new 3.4 GHz repeaters NoVs being issued.

GB3NV in Norwich on 3406 MHz and GB3HV at Farnham on 3408 MHz.

That should keep a few of us busy building equipment to get them on the air!

**G8GTZ**

---

### New kit from Hides

We are pleased to announced the first DVB-T PC USB Receiver Dongle with wide range (100MHz~2.6GHz, 4-band VHF/UHF/1.2G/2.4G) and versatile bandwidth (2/3/4/5/6/7/8MH BW) support, UT-130.

With UT-130 on a PC/Laptop Windows, users may tune and watch any DVB-T service which is transmitted in any frequency range 100MHz~2.6GHz or any bandwidth (2~8MHz BW) without any down converter required.

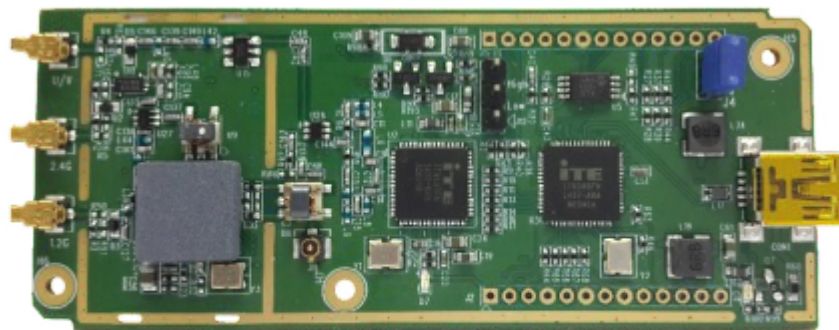

**UT-130**

Besides, a new down converter product BD-300, using the same technology as UT-130, is announced as well.

The new digital block down converter BD-300 supports excellent down conversion performance for both 1.2G and 2.4G band.

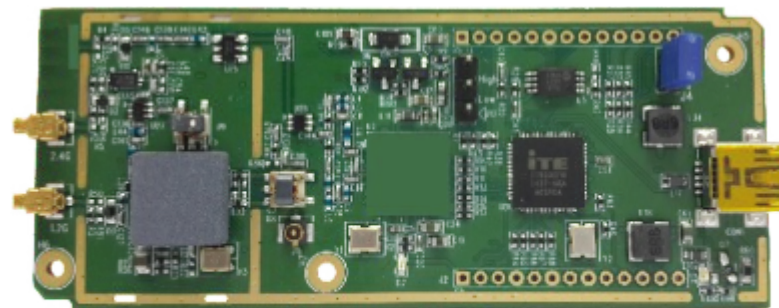

**BD-300**

The exceptional performance makes it the best solution for any OFDM RF signal down conversion, which might be easily distorted with legacy analog down converters.

BD-300's LO is software configurable, so it's very flexible for many applications in various frequency band.

Please find more details on the web shops.

UT-130 USB DVB-T 4-band (100~2500MHz, 2~8MHz BW) Receiver

[http://www.idealez.com/hides/product-detail/en\\_US/112888](http://www.idealez.com/hides/product-detail/en_US/112888)

or

[http://www.ebay.com/itm/UT-130-USB-DVB-T-4-band-100-2500MHz-2-8MHz-BW-Receiver-/321610250841?pt=Laptops\\_Nov05&hash=item4ae176fa59#ht\\_1132wt\\_834](http://www.ebay.com/itm/UT-130-USB-DVB-T-4-band-100-2500MHz-2-8MHz-BW-Receiver-/321610250841?pt=Laptops_Nov05&hash=item4ae176fa59#ht_1132wt_834)

BD-300 Dual-Band (1.2G/2.4G) Programmable LO Down Converter

[http://www.idealez.com/hides/product-detail/en\\_US/113081](http://www.idealez.com/hides/product-detail/en_US/113081)

or



[http://www.ebay.com/itm/BD-300-Dual-Band-1-2G-2-4G-Programmable-LO-Down-Converter-/321615520000?pt=Laptops\\_Nov05&hash=item4ae1c76100#ht\\_1154wt\\_834](http://www.ebay.com/itm/BD-300-Dual-Band-1-2G-2-4G-Programmable-LO-Down-Converter-/321615520000?pt=Laptops_Nov05&hash=item4ae1c76100#ht_1154wt_834)

Best Wishes  
Hides Technical Support Team

---

## Digital ATV on 146 MHz

When the RSGB VHF Manager John Regnault G4SWX gave a key presentation to the RSGB Convention on October 12 about the new UK amateur radio allocation at 146 MHz ([https://ukamsat.files.wordpress.com/2014/10/g4swx\\_146mhz.ppt](https://ukamsat.files.wordpress.com/2014/10/g4swx_146mhz.ppt)). John said the future use of this band is very much in our hands. John went on to suggest we should use the band imaginatively, with digital modes and/or new services that would not sit easily within the existing band. Digital ATV with 500 kHz bandwidth, Digital Voice, Spread Spectrum, Data Services along with things not yet widely thought of are the type of activity that is desired.

Charles Brain G4GUO has taken on the Digital ATV challenge and is working on software adaptation for the DATV Express project that will deliver narrow-band DATV transmissions in the new experimental part of 2m (UK Allocation) see <http://www.g4guo.blogspot.co.uk/2014/12/initial-1465-mhz-dvb-s-exciter-tests.html>. The current plans are to use DVB-S with H.264 video compression to produce a video frame rate that is as fast as possible. The only "missing piece" for 146 MHz DATV is more receivers that are capable of very low Symbol Rates. Currently only the Tutuone software from F6DZP running on the TT-S2-1600 PCI-based DTV-tuner board can receive this video, that is using SR=100KSymb/s (BW = 0.133 MHz) to SR=400KSymb/s (BW = 0.530 MHz).

---

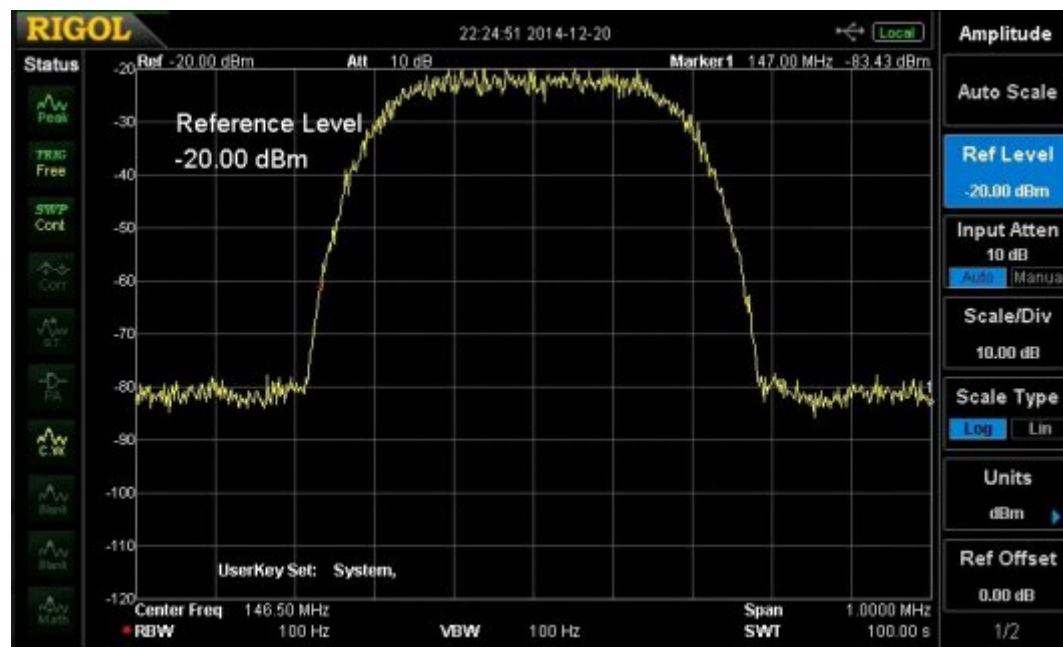

**DVB-S signal produced by DATV-Express exciter board on 146.5 MHz with SR = 333 KSymb/s. The frequency span on the Spectrum Analyser is 1 MHz.**

**RSGB VHF Manager  
John Regnault  
G4SWX having tea at  
home QTH**



Welcome to 2015 and CQ-DATV issue 19. I hope everyone had a good Christmas and has made their new year resolutions. Here at CQ-DATV we have made our resolutions, the first one is to keep CQ-DATV monthly. ATV needs magazine to bind us all together to exchange ideas and to circulate ATV knowhow. This can only work if the magazine we all read is happening at the pace everyone wants.

New this year is a better download page, that shows every issue we have produced, and each cover can be clicked through to show the contents of that issue.



We think that this will help you search our back catalogue of items without downloading every issue.

When we first started to deliver a free ATV magazine there may have been suspicions as to our motive, were you going to be inundated with junk mail, was the magazine going to be full of ads, were you leaving yourself open to cyber attacks. By now you should have realised there is no down side, CQ-DATV is here to stay and it has one aim and that is to support ATV.

This publication is a platform for all who are interested in ATV to exchange ideas and knowhow. There are no downsides as this is a magazine that is created by ATV enthusiasts for other ATV enthusiasts. We have aimed for a broad church from simple home construction projects, through to what is happening on the DATV scene and in this issue we have restarted Trevor's TV production column which was featured in issues 1, 2, 3, and 4.

We hope that there is something for everyone to read and enjoy. ATV is what joins us all together and is something we all feel passionate about and want to grow.

Please enjoy CQ-DATV 19 and let's hope we can grow it further in 2015, but remember this is your magazine and if there is something you think would benefit our readers well as they say in all the motivation speeches "Our door is always open".

In our case it is an electronic door, [editor@cq-datv.mobi](mailto:editor@cq-datv.mobi). Behind this door is the production team and all the contributors, we are happy to forward all your emails out to those contributors.

**Thank you and enjoy CQ-DATV 19  
CQ-DATV production team**



## Reader review comments on DATVtalk11

### Ken W6HHC

The following review comments were sent in by reader John AA3XN. The original article on ITU J.83b protocol for DATV was published in CQ-DATV17. Ron W6RZ in issue CQ-DATV18 provided some corrections and real mathematical answers for the estimates made by the author W6HHC.

I wish to add to the comments made by W6HHC with regard to. ITU J.83b.

The roll-off of 18% shown on page 7 of Issue 18 only applies to 64 QAM modulation. J.83b also defines 256 QAM modulation. The roll-off for 256QAM is 12%. This will produce a symbol rate of 5.3605 MSym/s in a 6 MHz channel.

This permits a transport stream rate of 38.8107 Mbps. Typically, and without rate shaping, a CATV system will use this modulation to insert 2 MPEG-2 HD streams. For example, this will allow two off-air HD streams running at 19 Mbps each to fit in a 6 MHz CATV channel. Though, you will find that through the use of rate shaping devices cable systems are placing 3-4 off-air HD's in a 6 MHz channel using 256 QAM modulation.

Ken W6HHC further commented "I want to thank John AA3XN for the additional information and interesting insight he adds concerning the ITU J.83b protocol. The early trials by US hams to use this protocol over-the-air used only 64QAM modulation (Mode 1) with 18% roll-off. As John explains above, 256 QAM modulation (Mode 2) can provide even more content with a 6 MHz bandwidth".



## Digital Amateur TeleVision Exciter/Transmitter

now available from

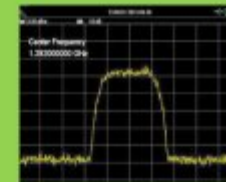

# DATV-Express



- A more affordable DATV exciter can now be ordered
- Fully-assembled and tested PCBA
- DVB-S protocol for DATV (using QPSK modulation)
- Can operate all ham bands from 70 MHz-to-2450 MHz
- RF output level up to 10 dBm (min) all bands (DVB-S)
- Software Defined Radio (SDR) architecture allows many variations of IQ modulations
- "Software-Defined" allows new features to be added over the next few years, without changing the hardware board
- As extra bonus, the team has been able to get the board to transmit DVB-T 2K mode, however we cannot guarantee the performance of that protocol. Caveat Emptor!
- Requires PC running Ubuntu linux (see User Guide)
- Price is US\$300 + shipping – order using PayPal

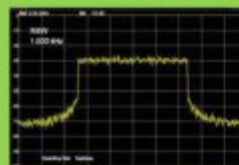

For more details and ordering

[www.DATV-Express.com](http://www.DATV-Express.com)

register on the web site  
to be able to see  
the PURCHASE page





# Local Oscillator PLL for Digilite project

**Fabrizio Bianchi IW5BDJ**

The most critical thing in realizing the Digilite digital ATV project is the Local Oscillator. This kind of oscillator must have very high frequency stability and a very low phase noise; these characteristics are mandatory for the correct project operation.

Traditional PLL oscillators don't have these high performance characteristics, so as a starting point, I used a properly multiplied quartz in order to reach the 1200MHz band.

With this system we can reach a good signal stability and purity that can satisfy also the most demanding OM but we need to find this kind of quartz in order to obtain just one frequency. This can be boring.

If we would like to freely operate along all the 1240-1300MHz band we must use something digital like a VCO driven by a PLL.

Analog Devices produces a VCO/PLL that can be directly coupled to AD8346 (Digilite Modulator) see schematic on Fig 1.

My challenge was to realize this circuit in the same way that it is suggested by the manufacturer. Practically I build an evaluation board using the chip ADF4360-5. There are many versions of this chip, depending on the working frequency we need and they are distinguished by a dash after the number. The lower the number after the dash the higher is its working frequency (-0 corresponds to 2725MHz; -9 corresponds to 60MHz). For our purposes the correct numbers could be -5 (1200-1400MHz) or -7 (350-1800MHz). I used the ADF4360-5 only.

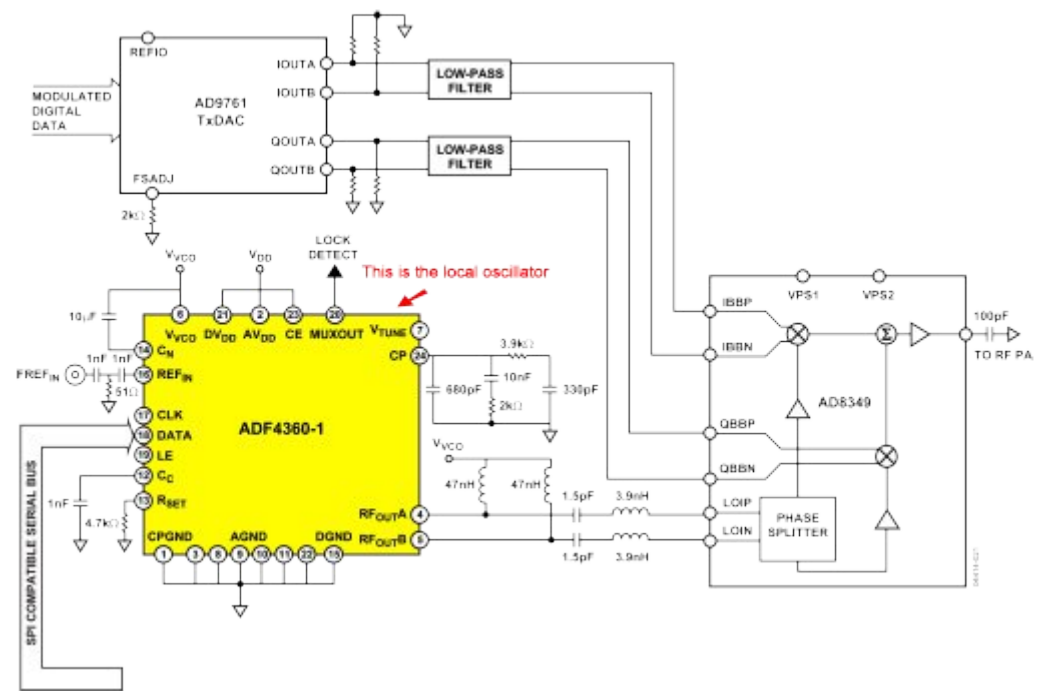

**Figure 1: Circuit suggested by Analog Devices for a digital data modulator**

This 24 pins (6 each side) chip has a square shape and it is really very small (5x5 mm), so the most difficult thing was to solder it to the PCB. With some precautions I did it using a hot air welder using also the precious advices of GB3UT by watching his at this link:

[https://www.youtube.com/watch?v=c\\_Qt5CtUlqY](https://www.youtube.com/watch?v=c_Qt5CtUlqY)

At the end it was quite easy to do. For the realization of the PCB I used Circad98 and I followed the scheme suggested by the manufacturer and reported here below Fig 4. This chip has a pad on its bottom side that must be connected to the PCB ground. This ground has to be connected also to the other side of PCB (Double faces PCB). To do this I made a hole of 1.8mm of diameter on the PCB exactly under the chip location and using a short piece of copper wire I soldered the

pad and performed the ground connection through the 2 PCB sides, see Fig 2. The PCB is made of a double sided epoxy glass FR4 1.6 mm but the circuit is only in one side of it. There are only 2 jumpers that connect the 2 sides of the PCB (blue colour in Fig 3).

To ensure ground connection between the two PCB sides I made some holes along the GND pad (green pads in Fig 3) and connected them using a thin copper wire soldered to the pads.

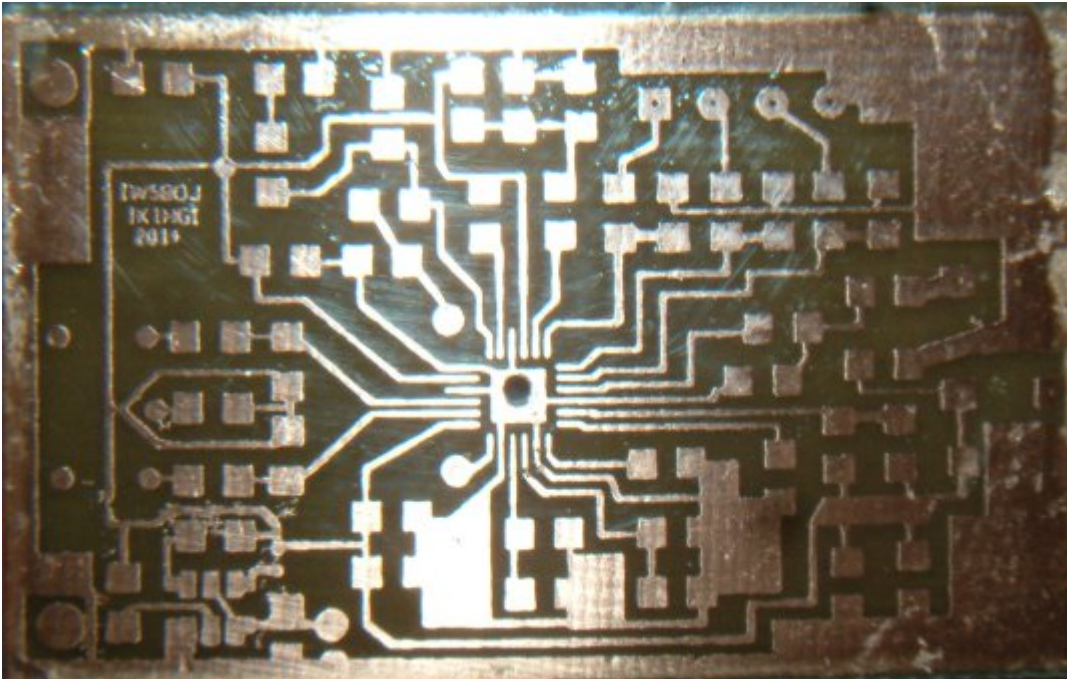

**Figure 2 : PCB with the hole under chip location**

After the very good results obtained from this experimental work we would like to couple this oscillator to the Digilite modulator excluding the ferrite transformer Toko. This will be our experimental work for next months with the goal of make a single PCB of modulator and L.O.

**Best wishes, Fabrizio Bianchi IW5BDJ**

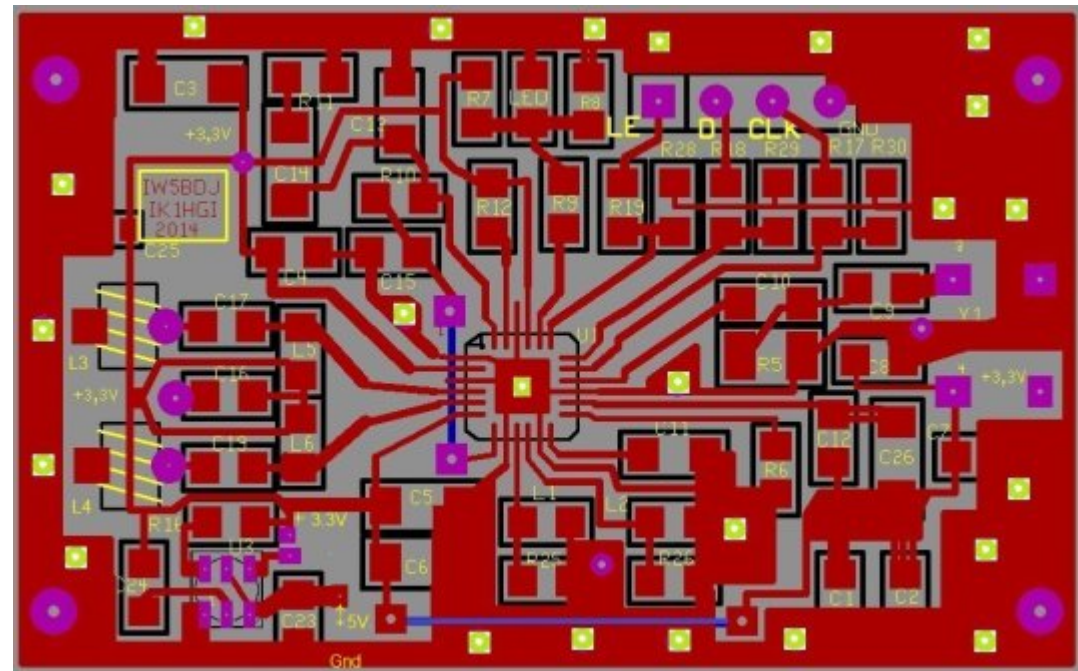

**Figure 3: PCB drawn by Circad98. Dimensions are 47 x 29 mm; the blue pads are jumpers made by copper wire to be placed on the other side of the PCB**

We thanks all Oms that contributed to this work and in particular:

- IK5SQS Daniele Casini *for English translation*
- IK1HGI Antonio Musumeci *for the first PCB draw using Circad98*
- IW5ECU Alberto Ciampa *for his precious advices on RF components*
- IW5BDJ Fabrizio Bianchi *has realized the first prototypes and he has performed all the tests on Digilite.*
- IZ5OQO Gianni Parricchi *who oversaw the positioning of microcomponents.*



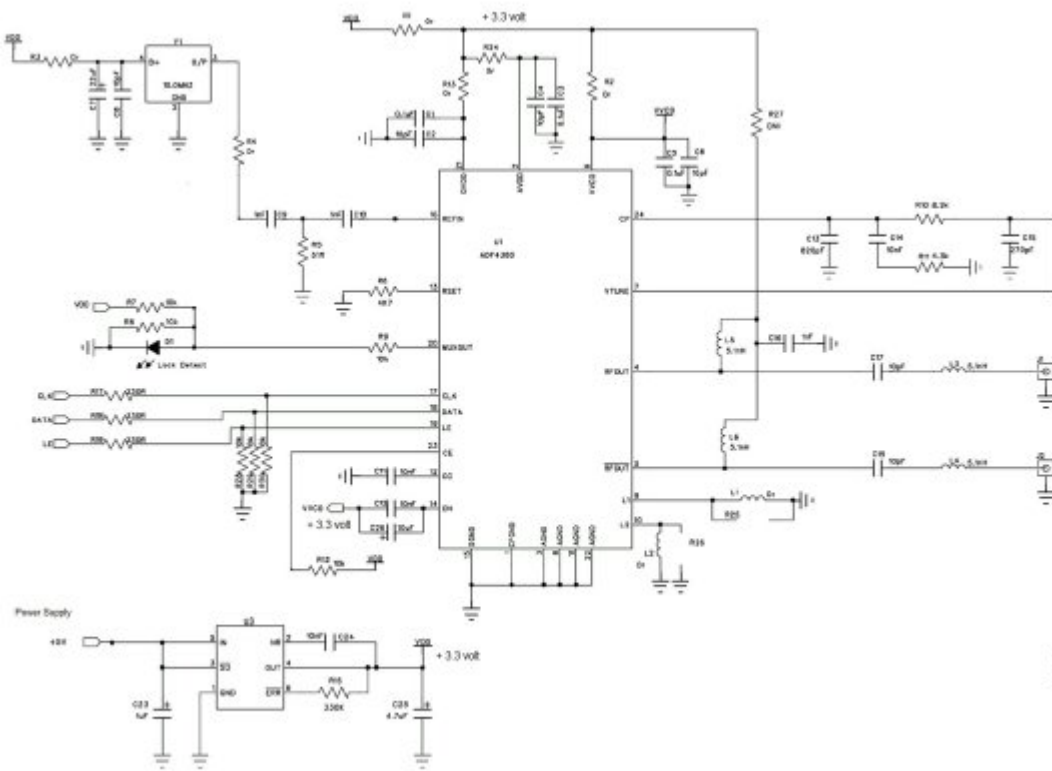

Figure 4: Analog Device ADF4360 -5 schematic diagram

Figure 6 (Right): The PCB, mirrored with dimensions

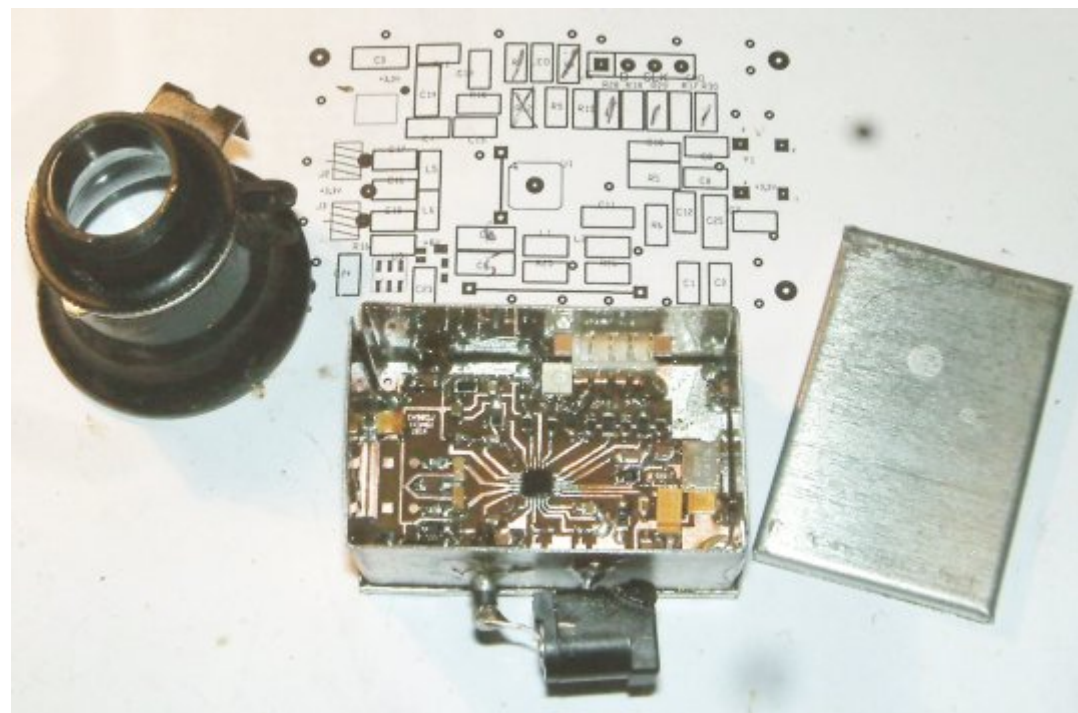

Figure 5: The first prototype realized

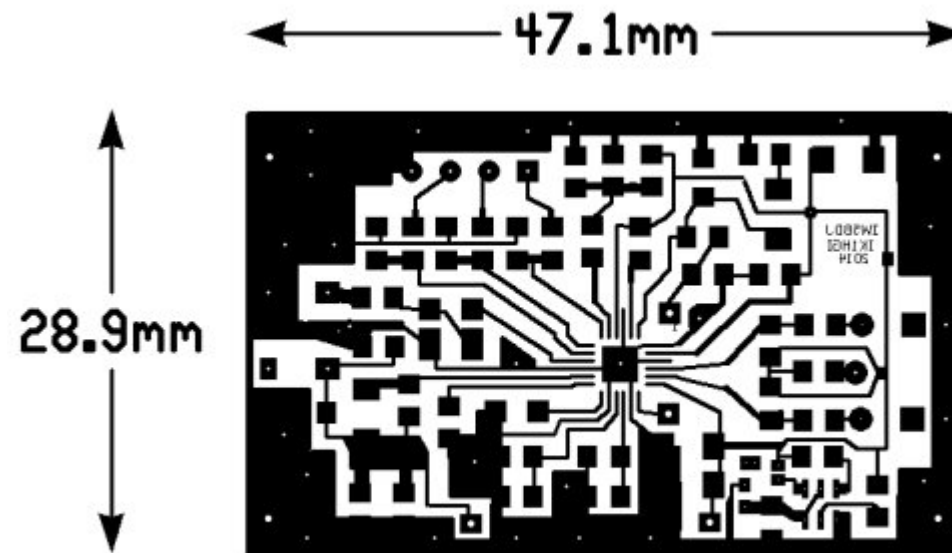
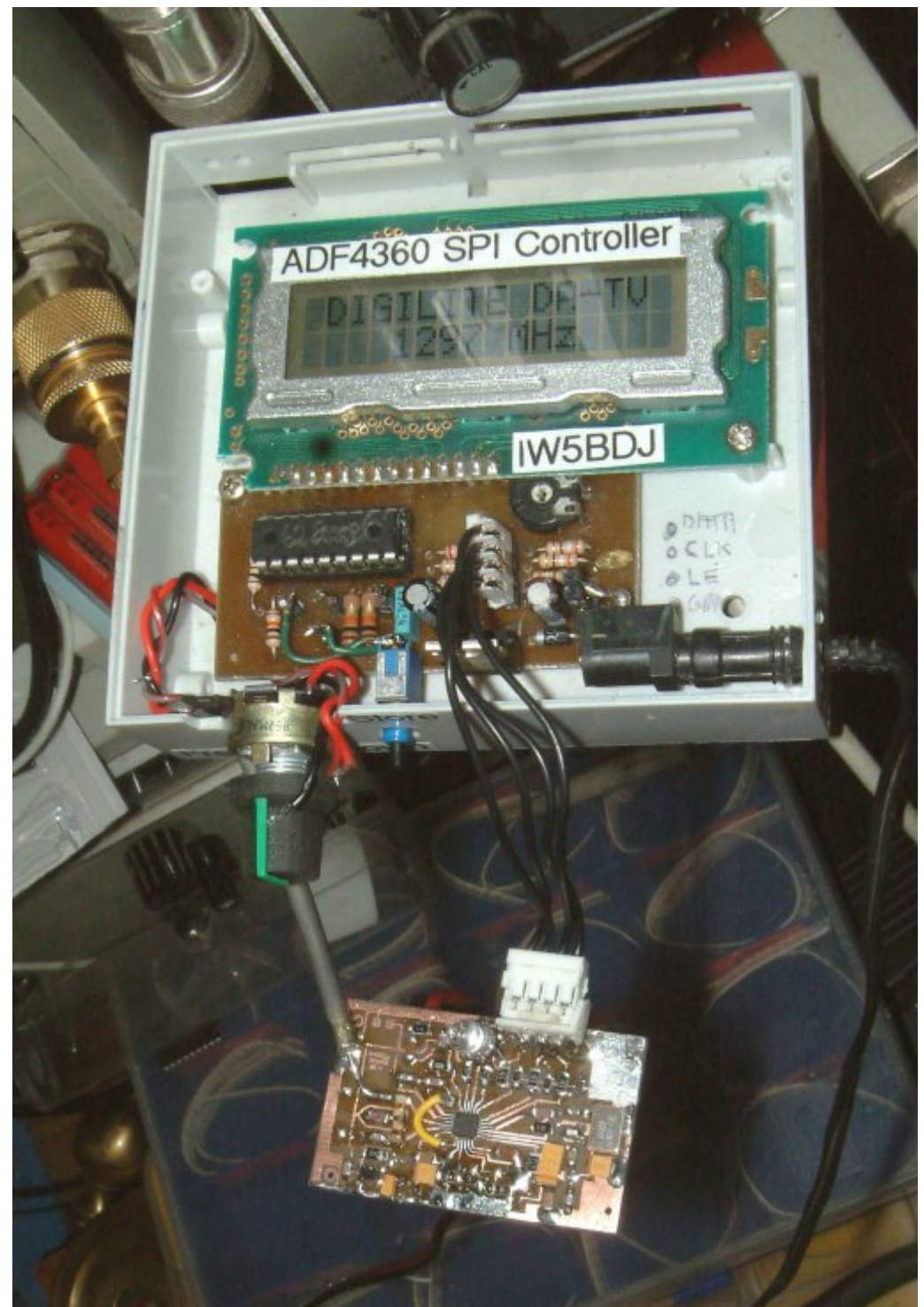

Table 1.

Reference Designator	Part Description
C1, C3, C5,	Capacitor, 0603, 0.1 $\mu$ F, 16 V
C2, C4, C6, C8	Capacitor, 0603, 10 pF, 50 V
C7	Capacitor, Case A, 22 $\mu$ F, 6.3 V
C9, C10	Capacitor, 0603, 1 nF, 50 V
C11, C12, C24	Capacitor, 0603, 10 nF, 16 V
C13	Capacitor, loop filter, 0603, 820 pF, 50 V
C14	Capacitor, loop filter, 0603, 10 nF, 50 V
C15	Capacitor, loop filter, 0603, 270 pF, 50 V
C16	ceramic capacitor, 50 V, X7R, 1 nF, $\pm$ 10%, 0603
C17, C19	Capacitor, 0603, 10 pF, 50 V
C23	Capacitor, Case A, 1 $\mu$ F, 16 V
C25	Capacitor, Case A, 4.7 $\mu$ F, 10 V
C26	Capacitor, Case A, 10 $\mu$ F, 6.3 V
D1	LED, SMD red High lum.
L1, L2	Resistor, 0603, 0 $\Omega$
L3, L4, L5, L6	Chip inductor, 5.1 nH, 5%, 0603 Farnel code 2285596
R25, R26	NO present on PCB
R5	Resistor, 0603, 51 $\Omega$
R6	Resistor, 0603, 4.7 k $\Omega$
R7, R8, R12, R28, R29, R30	Resistor, 0603, 10 k $\Omega$
R9	Resistor, 0603, 10 k $\Omega$
R10	Resistor, loop filter, 0603, 8.2 k $\Omega$
R11	Resistor, loop filter, 0603, 4.3 k $\Omega$
R16	Resistor, 0603, 330 k $\Omega$
R17 to R19	Resistor, 0603, 330 $\Omega$
U1	ADF4360-5 Analog Device <b>RS</b> code 7591578
U3	3.3 V regulator <b>RS</b> code 7091687
Y1	10 MHz TCXO <b>RS</b> code 7032098

Table 1 : Component list

Figure 7 (Right): Prototype in testing with SPI programmer from F1CJN:  
<http://www.g8ajm.tv/dlither4.html>





TYPICAL PERFORMANCE CHARACTERISTICS

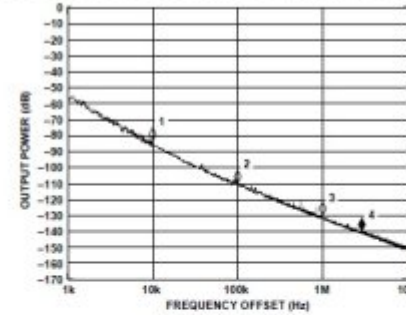

Figure 4. Open-Loop VCO Phase Noise

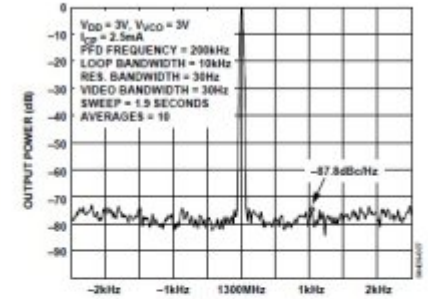

Figure 7. Close-In Phase Noise at 1300 MHz (200 kHz Channel Spacing)

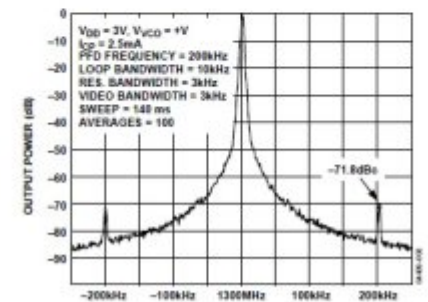
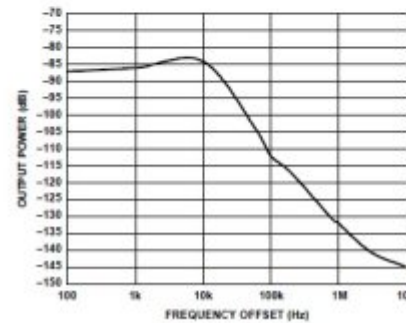

Figure 9: Measures from Analog Devices datasheet. [http://www.analog.com/static/imported-files/data\\_sheets/ADF4360-5.pdf](http://www.analog.com/static/imported-files/data_sheets/ADF4360-5.pdf)

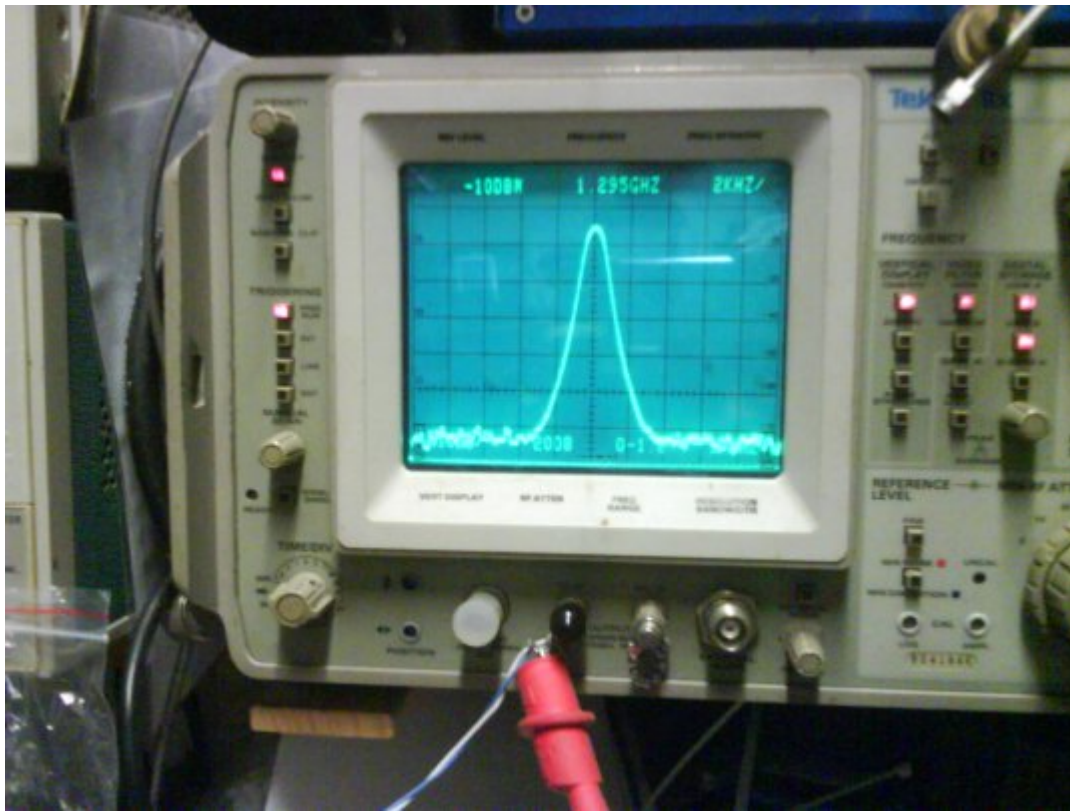

Figure 8: Very nice curve on Tek spectrum analyzer with band resolution of 2 kHz

Editor's Note: There are apparently still some of the (unpopulated) G8BYI controller boards available. Visit [www.g8ajn.tv/dlother3.html](http://www.g8ajn.tv/dlother3.html)

Also, the CIRCAD Version 4.0 data file (ADF4360-osc.pcb) for the PCB can be downloaded from the downloads section of the [cq-datv.mobi](http://cq-datv.mobi) web site.

Figure 10 (Right) : Frequency measurement with EIP 451 counter. Stable and precise!!



# DATV-Express Project - November update report

by KenW6HHC

Ken W6HHC, the "cross-training" trainee for project's debreate builds (under the helpful and patient "trainer" Charles G4GUO) ploughed through the ODROID U3 v2.03 .DEB build for ARMhf. The ODROID software for DATV-Express was completed, tested and released on November 28.

Updated README details, a new .DEB download file for ARMhf, and a separate User Guide for ODROID (Draft04) are now all available on the DOWNLOADS page for the DATV-Express web site at: <http://www.DATV-Express.com>

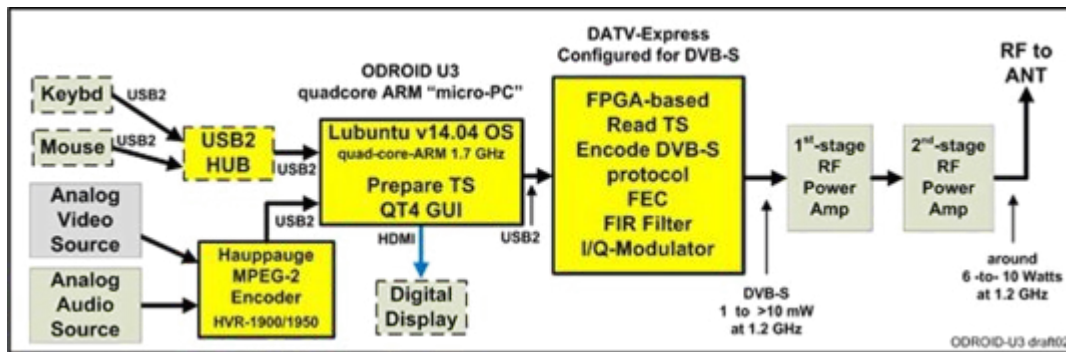

**Typical Block Diagram of ODROID DVB-S transmitter using DATV-Express**

The DATV-Express v2.03 software for ODROID model U3 performs all the functions using the Ubuntu 14.04 LTS operating system as the larger PC with Ubuntu OS, except DVB-T performance is more limited. One of the first tests run on the ODROID U3 was to try the new 1 MHz channel bandwidth mode for DVB-T that was added in the v2.03 release of software. 1 MHz bandwidth works well. DVB-T with QPSK in the 2 MHz BW mode was also tested. But, project

testing proved that one of the four ODROID CPU cores was NOT able to keep up with the required processing load for the 2 MHz BW testing. Charles G4GUO suspects that further DVB-T load-reduction improvements could possibly be done by rewriting parts of the software in assembly language (but, that assy code effort will not occur soon).



**Screen-Shot of Tutuone analyser receiving DVB-S using ODROID**

Ken W6HHC also wrote an article called "Digital-ATV - Using ODROID with DATV-Express board". This article can be found as DATVtalk12 in the free eMagazine called CQ-DATV18 that can be downloaded at:

<http://www.cq-datv.mobi/ebooks.php>

The article can also be found as TechTalk116 on the <http://www.DATV-Express.com> web site on the left side of the Home Page using the link called TECH TALK ARTICLES.



The plans for December are for the project team to relax a bit and focus on support to any questions and problems occurring from early ODROID users. The feedback from the field will help clean-up the User Guide documentation to become better.

### "setting project to cruise speed" ....de Ken W6HHC



# TV-AMATEUR

[www.agaf.de](http://www.agaf.de)

Nr. 175  
48. Jahrgang  
4. Quartal 2014  
ISSN: 0930-1016

Zeitschrift für Bild- und Schrift-Übertragungsverfahren



Vorstand und Redaktion wünschen allen Mitgliedern und Freunden der AGAF ein erfolgreiches Jahr 2015

Aus dem Inhalt: 4. HAMNET-Treffen in Wesseling bei Köln • Einfacher Mikrowellen-Detektor für 10 GHz  
25. ATV-Treffen Ulm in Thalfingen • Protokoll der AGAF-Jahreshauptversammlung 2014 in Glövizn



TV Amateur is a German language magazine. It is published 4 times a year. If you would like to subscribe, go to <http://www.agaf.de/>

# Using Raspberry Pi to feed a DATV modulator - no PC required

## Evariste F50EO

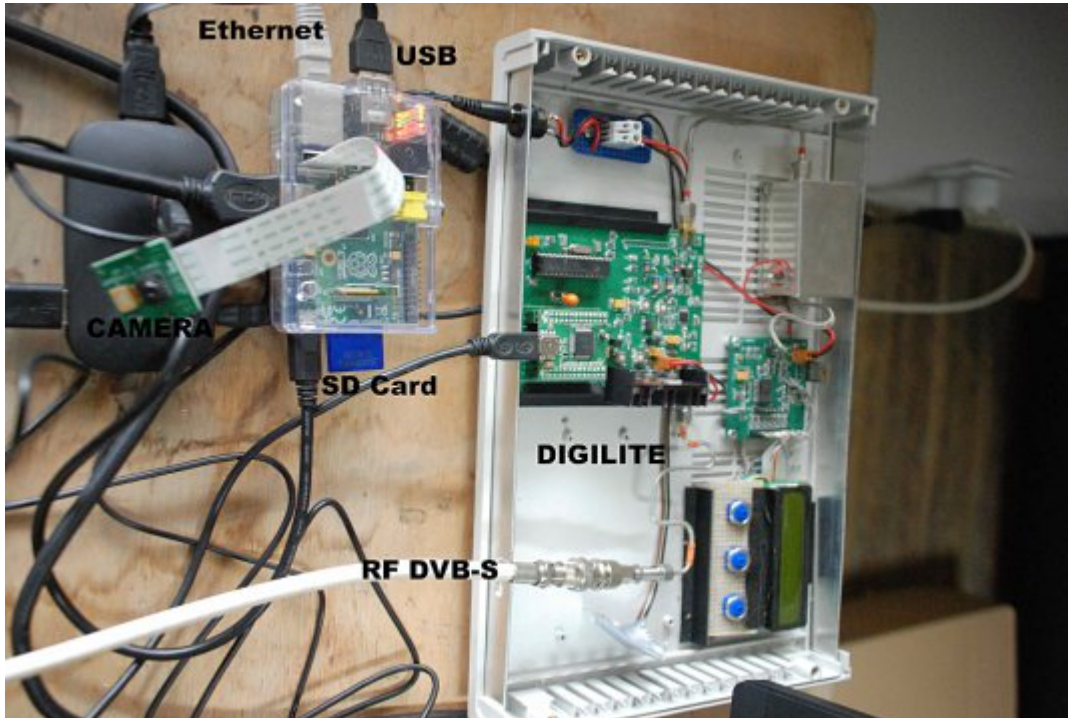

## Introduction

The Raspberry Pi is a little module running an ARM processor. CPU power computation is not very huge (like on a phone), but the hardware offers (among other) :

- 2 USB
- 1 HDMI or Composite output display
- 1 100 MBit/S Ethernet connexion
- 1 SD card where there is a Linux image on it
- An optional HD Cam could be added to acquire video

It seem that hardware required to feed a DATV modulator is in this system and thus could replace a PC and the video acquisition system.

The most suprising and powerfull feature is the hardware encoder/decoder. It allow to encode in REALTIME a very good quality video in H264. Most of the encoding done by the OM's nowadays is the MPEG-2 format. H264 is more efficient and enables a better quality for the same bitrate. On a normal PC, if you want to encode in H264 HD in software, it requires a very powerful CPU.

## Workflow

I acquired the video from the Raspberry cam. This video is encoded in a H264 elementary stream which is then processed to make a constant bitrate transport stream. This transport stream finaly feed a modulator.

All these processes are done on the raspberry and it is then completely stand-alone.

## Experiments with several modulators

### DVB-T

First I used the Hides UTC100D USB dongle which is a DVB-T modulator. Thanks to its API I could easily send the transport stream. No other process is needed.

### Digilite

Thanks to information from Brian G4EWJ and his great tool dvbs2enco, I could successfully send to digilite. Dvs2enco does the processing of transport stream 188 to Reed Salomon which is waited by the digilite. Thanks also to Rob M0DTS for his tips gained by his MK808 experience.



## Price of the solution

- Raspberry : 40 Euros
- Raspberry CAM : 25 euros
- SD CARD : around 15 euros

## Testing on your own

All the linux system that I have set up is on a SD card. I can easily copy it as an image which could be download by who wants to test it : no linux neither programming skill is required in a first time (only when if you want to look deeper on it). I hope that in such way, even no PC skill OM's could test the system !

## Future improvements

- *Developp a web interface to set parameters (which could be access by any device which have a internet browser : PC, Smartphone, Tablet)*
- *Add a receiver electronic part (DVB-S or DVB-T demodulator) in order to display directly to a screen*
- *Make multi-encoder through Ethernet to allow multiple program streams*
- *Add the module from G8GKQ to pilot the Ultram VCO*

And of course many other things.

**Please note: articles in this magazine are provided with absolutely no warranty whatsoever; neither the contributors nor CQ-DATV accept any responsibility or liability for loss or damage resulting from readers choosing to apply this content to theirs or others computers and equipment.**

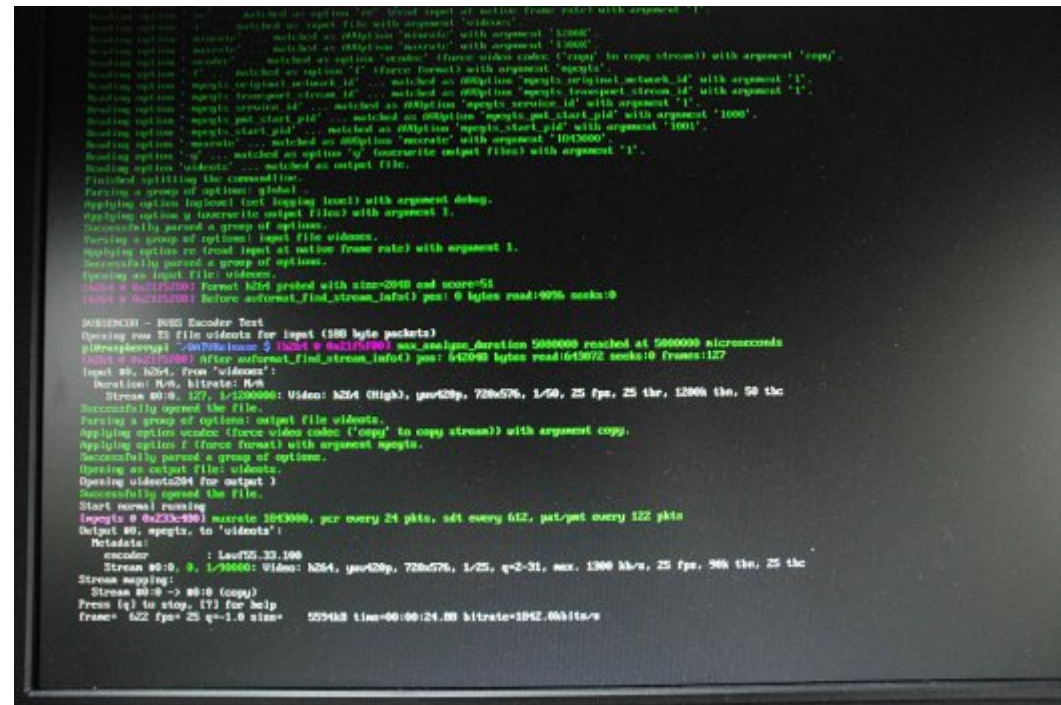
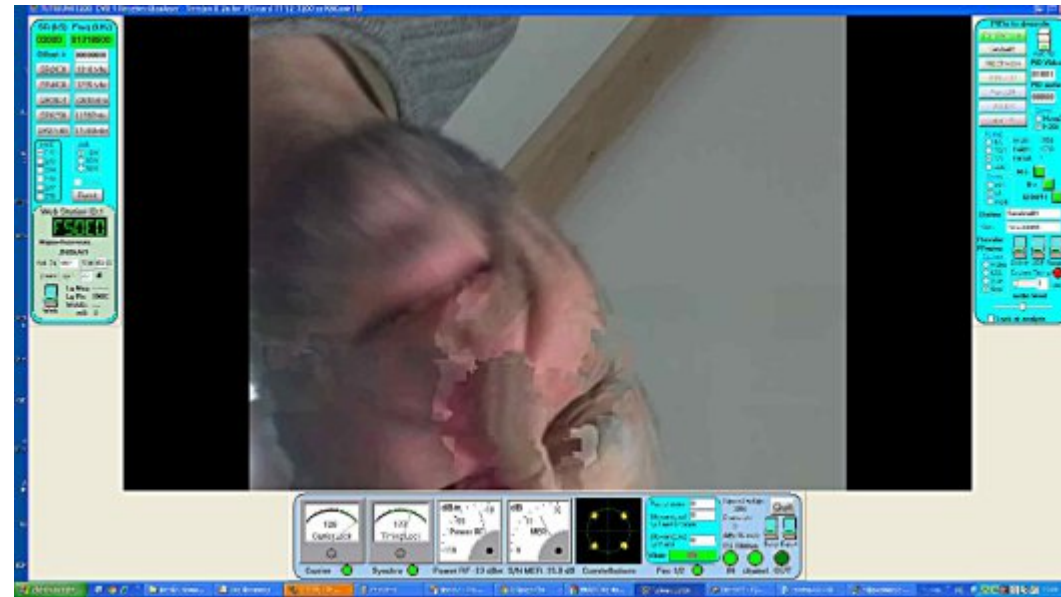

## Moving on with film making - Part 1

### Trevor Brown G8CJS

It seems a long time since Ian floated his idea for an all electronic publication for ATV. I was delighted that ATV was going to get another magazine and I contributed to issue 1, with an article on planning a video shoot for Christmas based on a previous year's Christmas experience. I followed it up in CQ-DATV 2 with how to plan and shoot a wedding video, CQ-DATV 3 and 4 were how to produce a multi camera production. Well we wanted a broad church magazine.

I have been asked how to take the production a stage further and what the next step would be. I initially recommended the wondershare editing package at £27 and the Canon S95 which can be found on e-bay for around £100. This will get you started, but if you want to go further...well you progress up the learning and also expense curve. Unlike the chancellor I don't have the luxury of increasing my borrowing requirement, but I did set up [www.video-vault.co.uk](http://www.video-vault.co.uk) so I could attract paying clients to help offset purchasing kit and little more to cover eating and living indoors. There are one or two must have items and there are one or two ways around buying the latest go faster goodies.

The first step is a better camera than the Canon Power Shot S95. As a camera, its brilliant value at £100. This has now been superseded by at least two models that from a movie point of view deliver a zoom that will work while recording and 1080p format instead of 1080i. Both nice to have but this camera still has a small aperture, non interchangeable lens and a small picture sensor. An internal only mic and well, if you are charging for your services, it does look less than professional.

Are small sensors a problem, well yes and no. Small sensors deliver a greater depth of field. Ok if you are in the CCTV

business and you want the subject to stay in focus for the duration of his or her transgression, but as film makers we want the opposite, shallow depth of field so any distracting backgrounds can be thrown out of focus. Using DSLR cameras rather than dedicated camcorders will give the edge in creating this effect. The reason being DSLR's use a single sensor called a Bayer array. Camcorders use three distinct sensors for Red Green and Blue. These require the light to be split in an Ice block for the three light paths and these extra components increase the distance between the rear of the lens and the sensors, which increases the depth of field.

The lens also has an effect on depth of field and a lens that will open up to a wider aperture, like F2.8 instead of limiting at F5.6 as is the case in the Canon Power Shot, will also help reduce the depth of field. A DSLR that has interchangeable lenses opens up a lot of possibilities. The confusing thing is which cameras have which size of sensors, as they all use different names. Fig 1 may spread some light on this if you will excuse the pun.

Fig 1

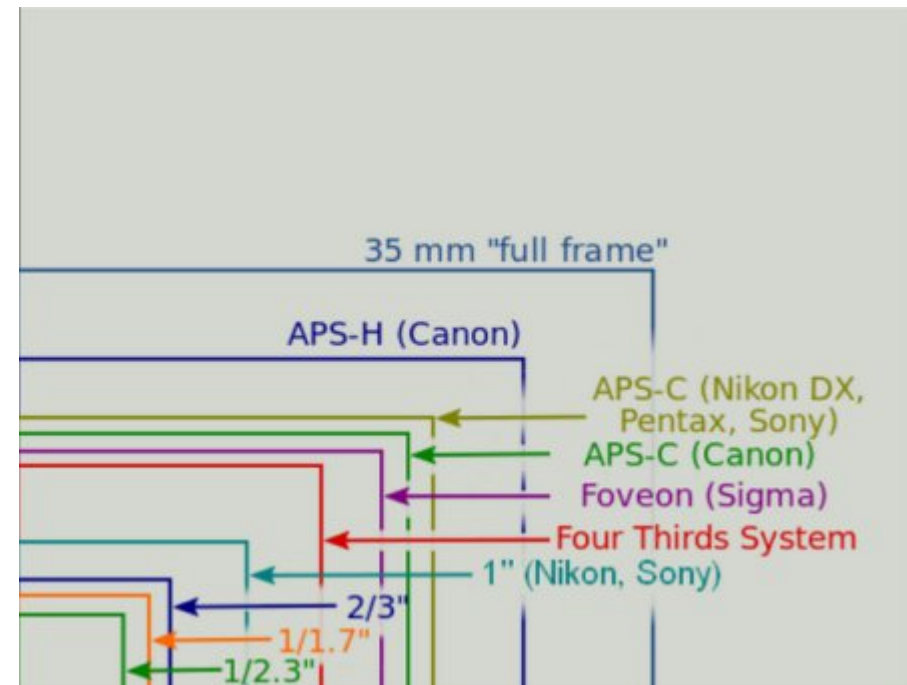



Full frame is obviously the winner. Most full frame DSLR tend to have removable lenses and every manufacturer has a different lens mount, so chose your DSLR wisely as any lens you buy will probably outlast the camera, but will lock you into a specific manufacturer, if you retain the lenses when you replace the camera.

There are also compatibility issues and a rough rule of thumb is full frame lenses will fit crop camera formats (smaller sensors), but crop format lenses will not fit full frame cameras. So let's buy at the top, but see if we can save some pennies along the way.

If you want to stay with Canon then the full frame EOS 5D is worth looking at, the MKII although produced for stills work,



with moving pictures added as a secondary function became very popular with film makers.

It had one major limitation and that was sound. The mic was internal and there was no way of connecting external microphones or headphone monitoring. Canon were not the only manufacturer to see the advantage of adding jack sockets to fix this problem and the MKIII was born.

This was a huge success with film makers as they often want to chose the style of mic and rarely want to site it with the camera. The problem was the cost, the MKII bodies can often be found on eBay at sub £500 and the MKIII is often three times the cost and you have not at this stage bought a lens, but when you do there is a lot to be said for prime focus (not zoom).

Prime Focus will always be less expensive, and have a larger aperture for reducing depth of field. There is little point buying a full frame camera and undoing all the effort with 5.6 zoom or worse a ramping zoom which will not maintain the F stop through its zoom range.

Is there a fix for internal mics only, yes do not record the sound on the camera, record it separately and in CQ-DATV 20 I will be looking at that, along with improved software for dealing with separate sound.

In the mean time if you want to indulge yourself and stay with Wondershare editing software, then the good news is, Wondershare will accept the files from the Canon EOS 5D....

Remember CQ-DATV issue 20 is only a few weeks away.

## 10 GHz SSB with a PLL LNB

By Michel Vonlanthen HB9AFO

The various "chapters" are input according to the news.

They follow in chronological order with the most recent at the bottom of this page

There are a few weeks F6HTJ Michel reported on the web, relayed by Francois F1CHF, that Spanish fans had installed in Alicante a receiver tuned to the ED6YAE CW beacon on 10 GHz (10368.880MHz / 1Watt), located on Ibiza Island.

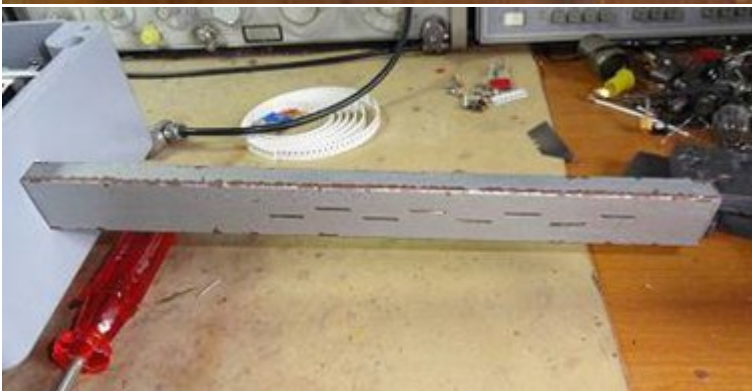
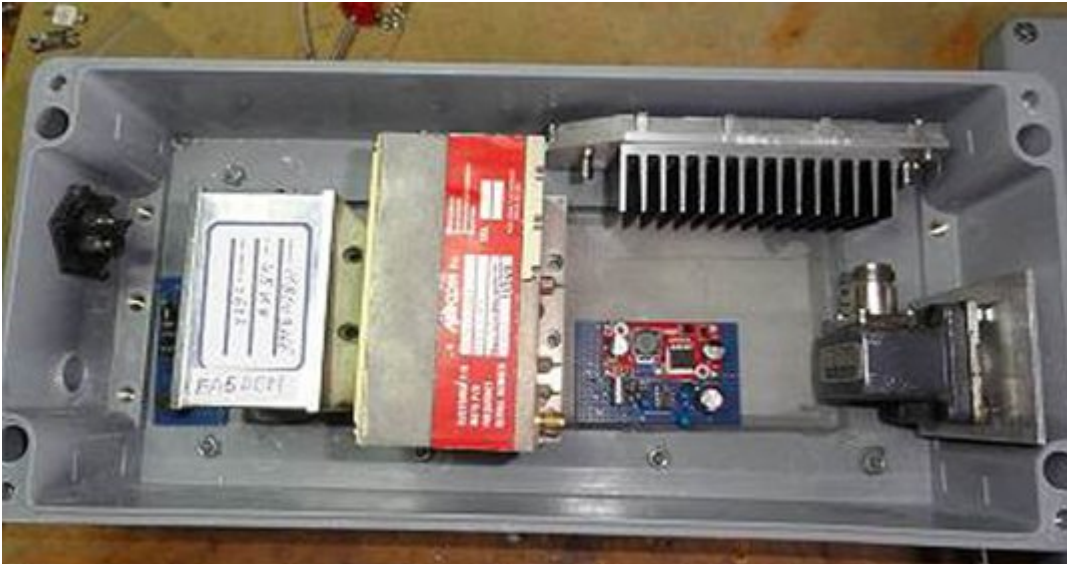

**The beacon,  
above, and  
slot antenna,  
left.**

**Right:  
Funcube Pro  
dongle.**

They coupled the output of the receiver to the Internet to enable everyone to receive this beacon. I began to listen and, indeed, I have heard the beacon.

<http://maxiplaya.dyndns.org:8901/>

According to Michel, the Spaniards used a PLL LNB, which excited me because, to date, the LNB were perfect for the broadband TV but not stable enough to receive CW or SSB. Therefore receiving CW with a LNB is a revolution. With one of these machines, you could receive SSB on 10 GHz at very little cost because the PLL LNB cost a little more than 10 Dollars (20 with the port).

In the process, I contacted the two authors of this project, EA5CV and EA5DOM. He confirmed to me that they used an unmodified Avenger PLL LNB, followed by a FUNcube SDR receiver the size of a USB key that plugs into the USB port of a computer.

The receiver was tuned to 618MHz, or (10,368MHz - 9,750MHz (frequency of the local oscillator of LNB) The output of the LNB is apparently large enough to support this frequency deviation from the lowest receiving frequency of a satellite TV receiver (that is 850 MHz).

The purity of the reception is good, the signals are clean, the





short-term stability is sufficient to complete a QSO. Long term stability depends on the ambient temperature, but the variations are of the order of several tens of kHz, not more. It all looks very well and can be seen listening to the Ibiza beacon.

In summary, the receiving equipment in Alicante includes:

- a satellite dish pointed to Ibiza
- an unmodified Avenger PLL LNB
- a FUNcube SDR receiver
- and WebSDR software to broadcast the received signal on the web here: <http://maxiplaya.dyndns.org:8901/>

On the net, there is a receiver on the screen and you can change the settings exactly as if you had this receiver on your own computer at home. The frequency can be varied, change the mode of reception, vary the bandwidth received, in short everything you can do with an SDR receiver.

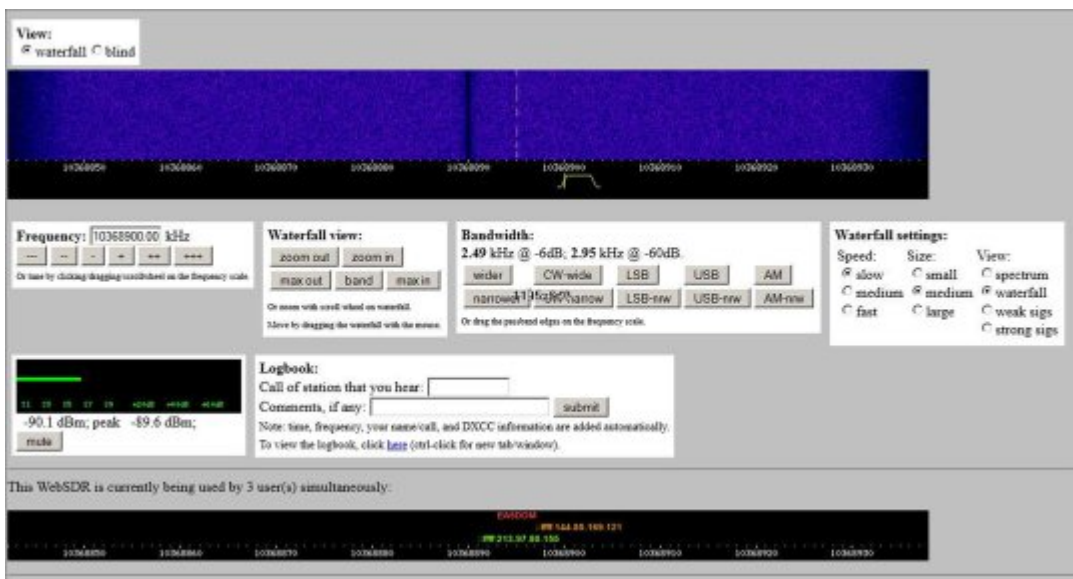

A screenshot of the software.

PLL LNB means the LNB oscillator is stabilized by a Phase Locked Loop which explains the exceptional stability of this type of LNB.

F1CHF then proposed to group our PLL LNB orders to lower the cost. But I did not have the patience to wait and immediately ordered two , one single and one double output IF.

Just about 20 Dollars with the port:

<http://www.ebay.com/itm/Avenger-PLL321S-2-0-1-dB-Universal-Single-Linear-Ku-Band-Satellite-Dish-LNB-LNBF-/320886789074?>

And the double, about 30 Dollars):

<http://www.ebay.com/itm/ws/eBayISAPI.dll?ViewItem&item=370695192002&ssPageName=ADME:L:OC:FR:3160>

Both were delivered in less than a week.

The PLL-LNB single output looks like this:



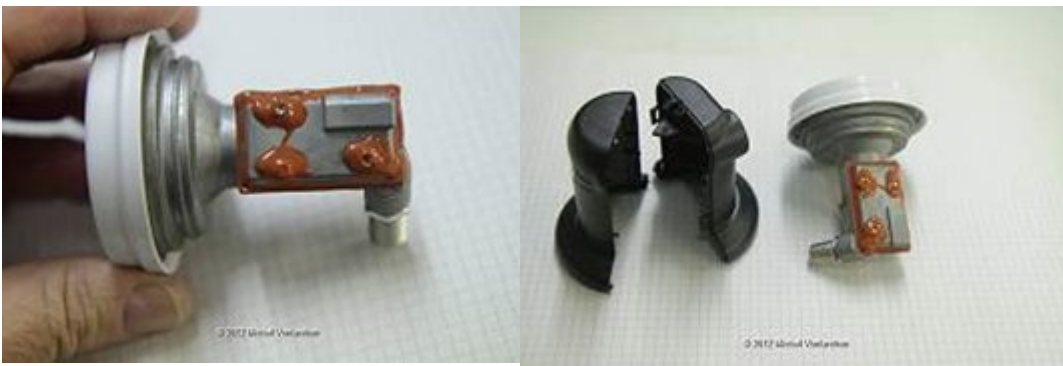

What it says on the box, only information supplied by the manufacturer:

*Digital KU Band LNBF single  
Avenger PLL321S-2  
Input freq: 10.70 - 12.75 GHz  
L.O.freq: 9750 & 10.600 GHz  
Noise figure: 0.1 dB  
Mounting: 40 mm  
<http://www.dmsiusa.com>  
Made in China*

I made the first SSB-CW tests with my transverter in transmission and in reception, the PLL LNB follow my old broadband and fixed on all modes AR3000 receiver on 618 MHz. The received signals were of excellent sound quality but the LNB was completely saturated with the 1 Watt transmitter connected to a dummy load. First satisfactory tests but also needed to refine them because it would be interesting to measure the sensitivity of the LNB and also to see what was inside, because it's tiny, 30 x 20mm. It's amazing to be able to fit a TV-SAT LNB in such a small volume! But I'll wait to receive my 3 LNB controlled by F1CHF before opening a sealed LNB because it is sealed with a kind of red gum. On the other hand, there are socket head screws that seem to be fixing screws.

One thing I noticed immediately: the LNB heat. This is very noticeable when touched by hand. This effect is much less with a traditional LNB. Probably the result of high component integration because it should be tight inside. Incidentally it may also contributes to the stability of the frequency, the temperature is more constant than in a cold case.

Some findings:

- *Consumption is 160mA at 12 volts.*
- *At switch-on the frequency of the local oscillator is about 9.75GHz.*
- *Receiving CW and SSB is of good quality.*
- *The frequency does not vary when the power supply voltage changes, even of several volts.*
- *Single output LNB has the same sensitivity as the 2 output LNB.*

Francois, F1CHF, opened one of the LNB's. Amazing that there was little inside. No IF filter in any case, that explains the large width of the output signal. On mine, it falls quite sharply below 500 MHz, but above it is relatively constant on the AR3000 s-meter.

I did some testing and comparison with satellite TV all day. No big differences with a standard LNB, it is a difference of 2 bar-graphs "intensity" and "quality." With this LNB, "quality" is almost always higher than "intensity". I do not draw much conclusion, because the information is a bit of folklore. But perhaps the stability of the oscillator would improve the decoding quality?

Without apparatus for measuring, but with the AR3000, I compared sky / ground noise between the 2 LNB.. The PLL is much more "noisier" than the standard LNB. Sign of better sensitivity perhaps? I hope so but it may also be possible that



it is the absence of filtering which reduces noise and pushes up the s-meter. I hope that Dominique F6DRO will do a serious measurement on them..

I am thinking of building a converter for 600 - 1000 MHz to exit the LNB to a satellite TV receiver for receiving ATV-DATV. This way, I could be QRV all modes ATV-DATV-SSB-CW-AM-FM-WFM with single dual output LNB. This could be useful for portable listening.

To change polarization electrically can be useful, especially in a fixed location, because this is one of the most spectacular applications of this PLL LNB: you can put it on the roof to make the all-mode reception. Receive 10 GHz CW beacons, rain-scatter signals (RS), ATV-DATV, everything is possible with this machine.

It's great is not it?

I re-did an ssb acceptance test using my transverter but this time moved one floor above in order to have a weak signal. I unfortunately have no stable generator for 10 GHz but I'll experiment with a Synfox + multiplier to see if I can get something to work. Or maybe with a converter and a good filter to avoid excessive drift due to mutiplications. We'll see. Anyway receiving weak SSB and CW signals is excellent with the LNB.

I must say that this PLL LNB gives me lots of energy and desire. This is a Christmas present of our Spanish friends!

### On the F1CHF website:

- [Photos of the interior of the PLL LNB](#) (PDF - in French) (often updated by Francois)
- [Specifications of the Avenger PLL LNB](#) (PDF - in English)
- [Data sheet for the transistor NE3503M04](#) (PDF - in English)

### Estimation of the rejection of the image frequency:

- *Generator: synthesised HP multiplied by 16 with a 1N23 diode in a waveguide.*
- *Receiver: PLL LNB 20cm guide + attenuator + RX AR3000*
- *Fo LNB: 9750 MHz*
- *The IF AR3000: 618 MHz*
- *Finput: 10,368 MHz*
- *Fimage: 9,132 MHz*
- *Rejection: about 10 - 15 dB*

To be confirmed because the measurement conditions are rustic but this is a first indication.

### SUP-2400 converter

It gets crazy, I do not have time to breathe, news arrives with a bang! That now you can buy a DirectTv SUP-2400 KA/KU B-Band Converter for 8 Euros. A marvel which converts the 250-750 MHz range to 950-2150 MHz, as received by a satellite TV receiver. So we can directly receive 437 MHz and also connected behind a PLL LNB, receive DATV or ATV on 10 GHz. In addition it's real pro, synthesized and everything!



**The converter**

[Link to more detailed description in English.](#)

## First measurements by Dominique F6DRO - 2013.01.10

I had a little time to work on the PLL LNB, because the weather is still bad outside.

I looked at the low band. The lowest frequency in the data sheet is 10.7Ghz, I wanted to see how the filter and the IF amp behave at 10,368. I found 6dB less signal at 10,368, it is acceptable if the NF does not take too severe a blow.

Output is remarkably stable, even when heated a little.

The rejection of the image frequency is consistent with that given in the data sheet (> 40dB), which is sufficient for our app. This both 11.7 and 10,368.

Looking at Francis' photo, the filter seems embryonic.

The input waveguide is quoted as the diameter of 18mm (and maybe less, I do not have the right tools to measure), so:

$$\text{LambdaC} = 1.706 * D = 30,708\text{mm}$$

$$\text{Cutoff} = 299.8 / \text{LambdaC} = 9,76\text{GHz}$$

### Cutoff frequencies:

Low band (the only relevant one):

$$\text{RF} = 10,7\text{GHz} - \text{Lo} - 9,75\text{GHz} = \text{If} = 0.95\text{GHz} \gggg \text{Image} = 10.7 - 2 * \text{FI} = 8.8\text{GHz}, \text{Below } \lambda C, \text{ so attenuated by the guide}$$

$$\text{RF} = 11.7\text{GHz} - \text{LO} - \text{IF} = 9.75\text{GHz} - 1.95\text{GHz} \ggg \text{Image} = 9.8\text{GHz}, \text{ close to the cutoff}$$

## Band without altering the LO:

$$\text{RF} = 10.368\text{GHz} - \text{LO} - \text{IF} = 9.75 = 618\text{MHz} \gggg \text{Image} = 9.132\text{GHz} \text{ Below cut guide.}$$

Assuming that the filter in the set can pass the 432 (?):

RF=10368 LO=9.9GHz IF=432 Image 9.5GHz, Knowing that to try to modify the LO, it is likely to do what you want by changing the quartz PLL. Nevertheless it would be more prudent to use an IF at 1296.

RF=10.368 LO=9.072 image 7.7GHz, assuming that the PLL accepts LO on 9GHz (LO = local oscillator)

To follow: Noise measurement

## 2013.01.11

Finally some sun, we had not seen it for a while. I was able to do noise measurement of the PLL-LNB. Be careful of the gain and therefore careful not to compress the signal. I made several measurements with multiple attenuators to be on my aim.

Setup:

PLLNB + Attenuator (0/6 / 20dB) + transverter + 1296/28 + SDR-IQ under Spectravue.

Do not use the 0dB, it compresses the noise measurement 1dB, with 6 and 20db, same result. noise measurement to 11GHz (9.75 + 1.296) equals 6,5dB, a NF of 0,9dB.

For me, given my application, it is enough for me, but obviously, there has been no progress on the NF of LNB's for a long time.



## Test variation of the frequency of the LO PLL-LNB by F1CHF

Francois happened to vary the frequency of the local oscillator PLL LNB by removing its reference quartz (in the 27 MHz) and replacing it by a generator signal. With three main results:

- To receive 10 GHz with a 430 MHz receiver
- Able to receive ATV / DATV with a standard satellite TV receiver (950-2050 MHz)
- Generate 10,368 MHz usable as a beacon

Photos of the interior of the PLL LNB and measurements

Data sheet of the PLL IC RDA3560M:  
<http://f1chf.free.fr/LNBPLL/RDA3560M.pdf>

## First tests of the SUP-2400 converter



**The complete set**

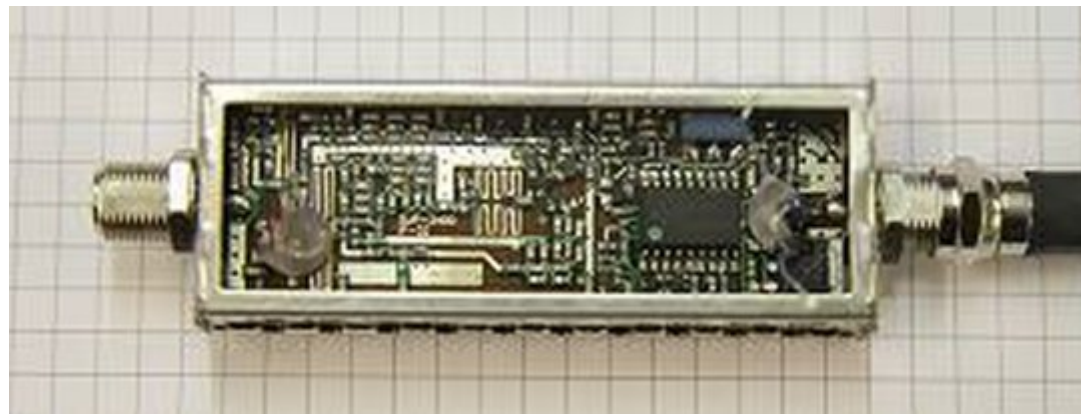

**HF side view**

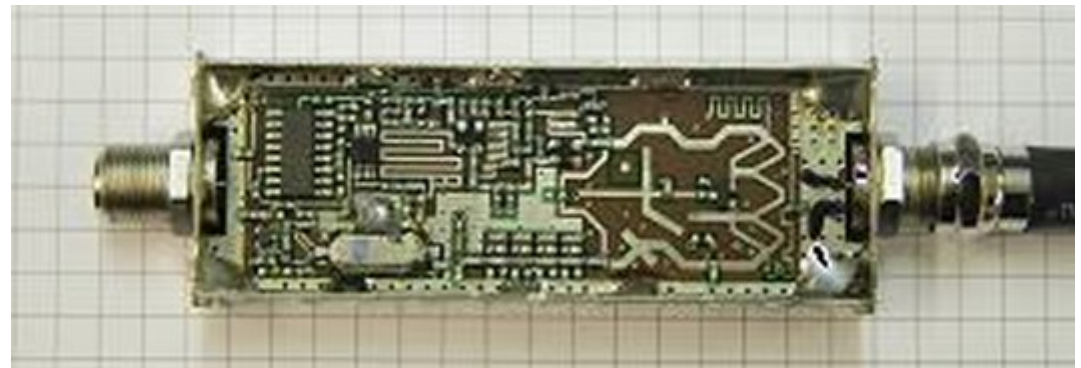

**PLL side view**

I just froze my butt in the snow trying to make the reception of the relay DATV HB9IBC with PLL LNB. Not received but it was sadly predictable from where I was before the house, I'm surrounded by houses and do not see the relay Dole. I gave it a shot at random hoping for a miracle!

I was ready to shout "miracolo" as in the film "Bicycle Thieves" by Vittorio De Sica. Where the hearsay bike thief exclaims "miracolo" when the officer asked him was this bike stolen in his corridor!

Pics next page:-

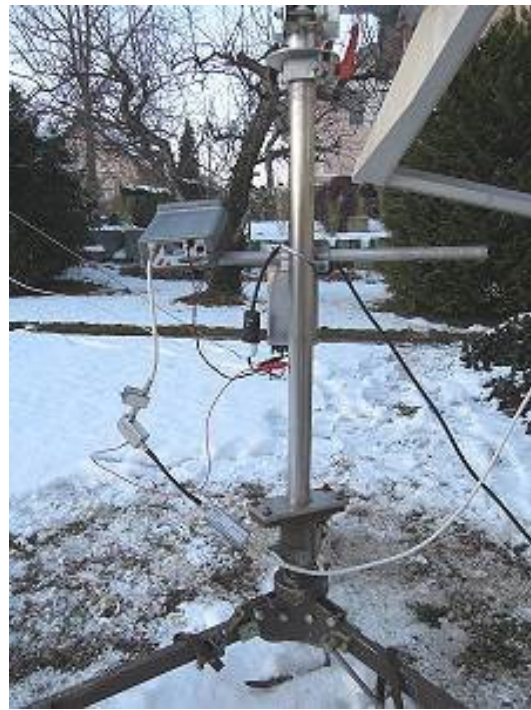

SUP-2400 I did some measurements to the generator and the receiver chain.

### Six findings:

1. Short-term stability of the converter is not good for the reception CW / SSB.

It's usable, but it slides like a bar of soap, even after a great time to warm up. By contrast, there is no downgrade of the signal. This converter is much less stable than the PLL LNB and degrades the stability of the receiver assembly. Its use reminds me of the Geloso VFO of my youth!

But it is clear that for ATV and DATV receiving, it's not a problem. Stability is generally much better than that of a standard LNB (with DRO) alone.

2. The insertion of the converter in the receive chain does not degrade the signal / noise of the PLL LNB but slightly reduces the signal from the LNB

One can easily make this measurement by first making reception without a converter :

PLL LNB: End = 10'368 MHz, 9750 MHz IF = Lo = 618 MHz received on the AR3000.

The converter goes up the 618 MHz in the range of satellite TV receiver:

SUP-2400: End = 618 MHz, 2400 MHz = Lo, Fout = 1782 MHz received with the AR3000.

3. The SUP-2400 gets very hot.

So much so that I suspected a failure at the outset. But that's okay because it uses 400 mA.

4. To date, my all mode receiver is based on 10 GHz PLL LNB

I tried the reception hoping to hear a variation or a very small amount reception of the relay with my AR3000. The equipment was:

Dish 90 / 100cm Visiosat, PLL LNB, SUP-2400 converter, power injector, variable attenuator and AR3000.

Failing to get over, I received my signal generator + multiplier 10 GHz which was in the basement of the house, so received through the window, but without direct view. I could turn the antenna in all directions, the signal was QRO and did not disappear (in position CW). With this kind of source, unfortunately I can not measure the PLL LNB sensitivity because I do not know the level at 10 GHz output multiplier of my fortune. I can only make comparisons, so a rough estimate.

It's been several days since I was testing with the PLL LNB and AR3000. And as the day before yesterday I received my



with the AR3000 receiver behind for SSB-CW. And for the ATV / DATV, I will insert the SUP-2400 between the PLL LNB and the satellite TV receiver.

The ideal will be to change the frequency of the LO in the PLL LNB by changing its quartz or adding an externally stable oscillator.

F1CHF determined we could do the reception of 10 GHz with a 430 MHz IF with this method. One can also push the LO so that the IF happens at 1000MHz, which would authorize the receipt ATV / DATV with a satellite TV receiver without using intermediate converter.

But without touching the PLL LNB with my current equipment, I can already do all reception modes 10 GHz ATV / DATV / SSB / CW / AM / FM to a ridiculous expense: 10 Dollars for PLL LNB, the same for the SUP-2400 converter. It's really a quality / price never achieved before!

5. Before using the SUP-2400, we must make the change described by Marcel F1GE:  
<http://www.uhf-satcom.com/misc/datasheet/SUP-2400.pdf>.  
You just have to solder a small wire between a resistor and a transistor. It eliminates the need to select the frequency of the LO signal with a Diseq at startup.

6. It should be remembered that the input signal is reversed in the converter (infradyne receiver) since the frequency of the LO is greater than that of the received signal. The formula is:

$$F_{out} = LO - End$$

(Example:  $F_{out} = 2400 - 618 = 1782$  MHz)

## SUP-2400: F3YX Measurements

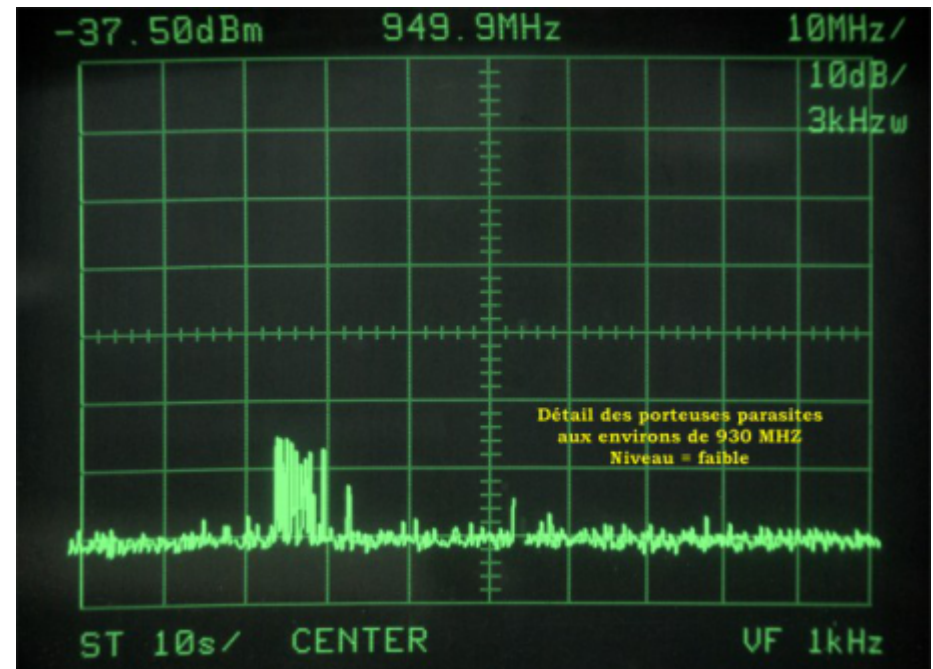
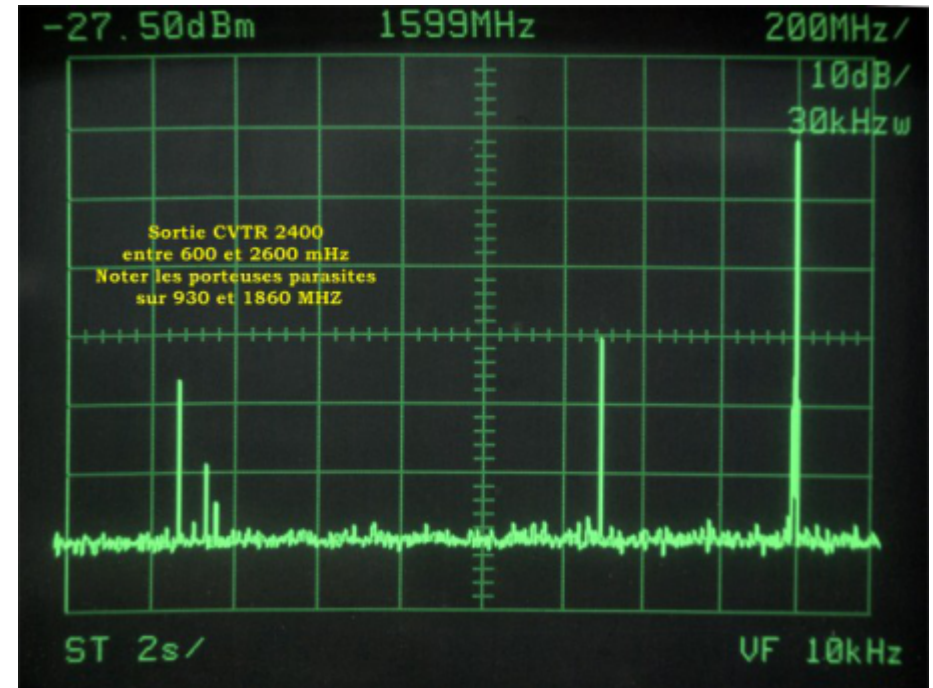

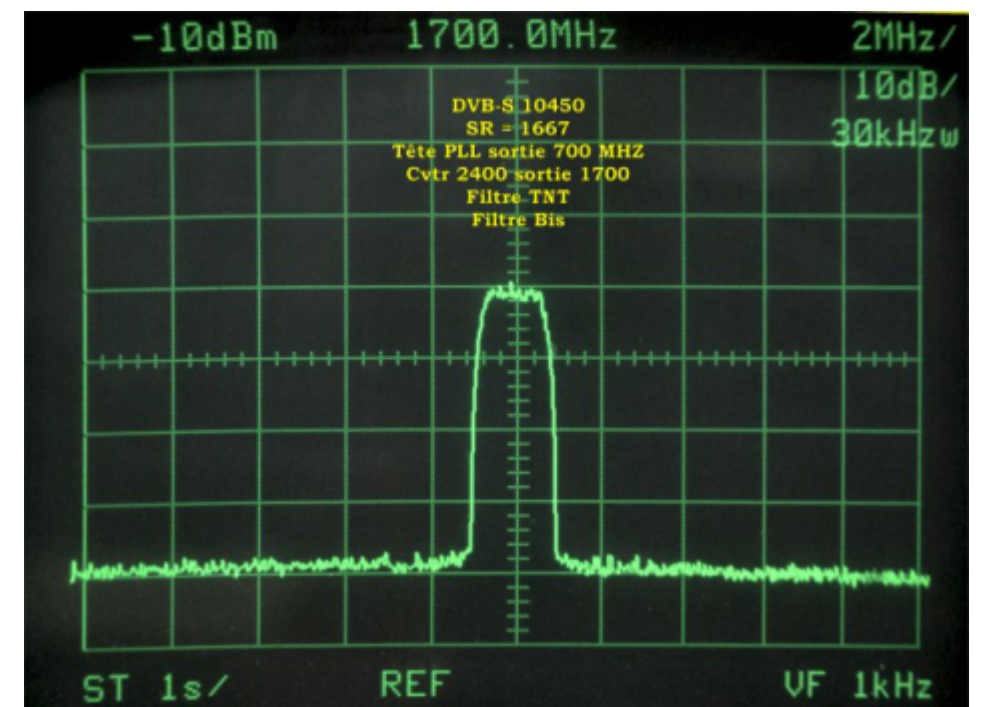
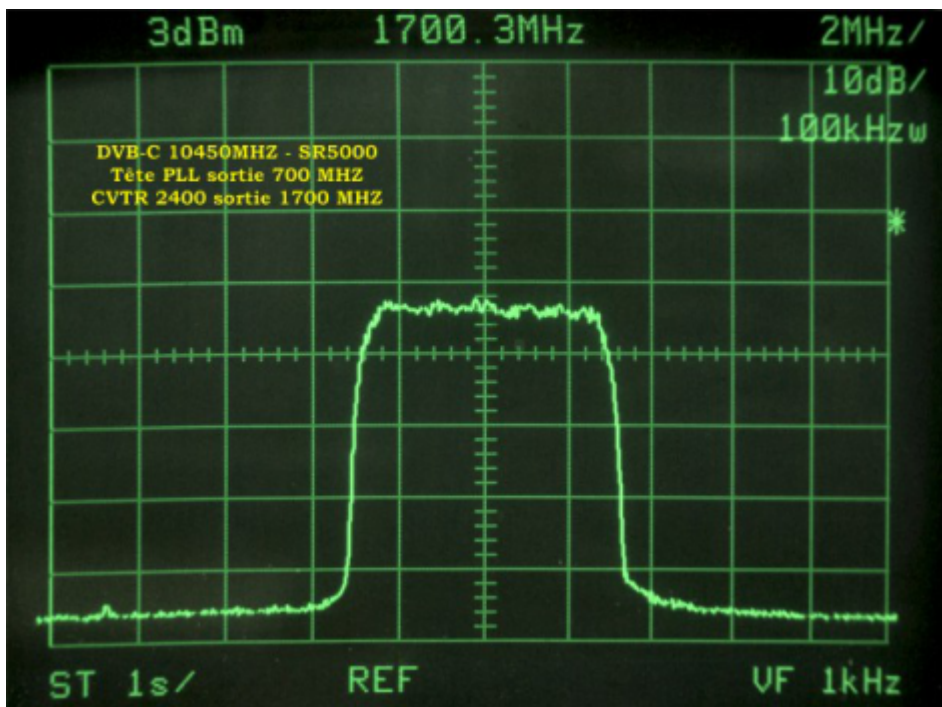
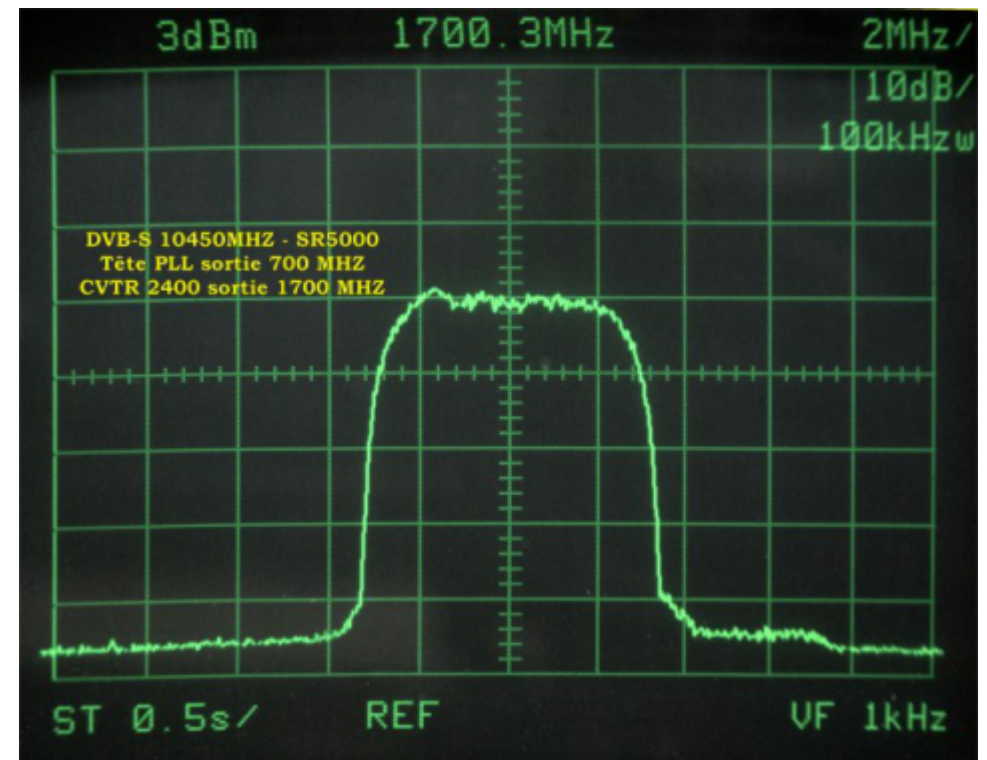
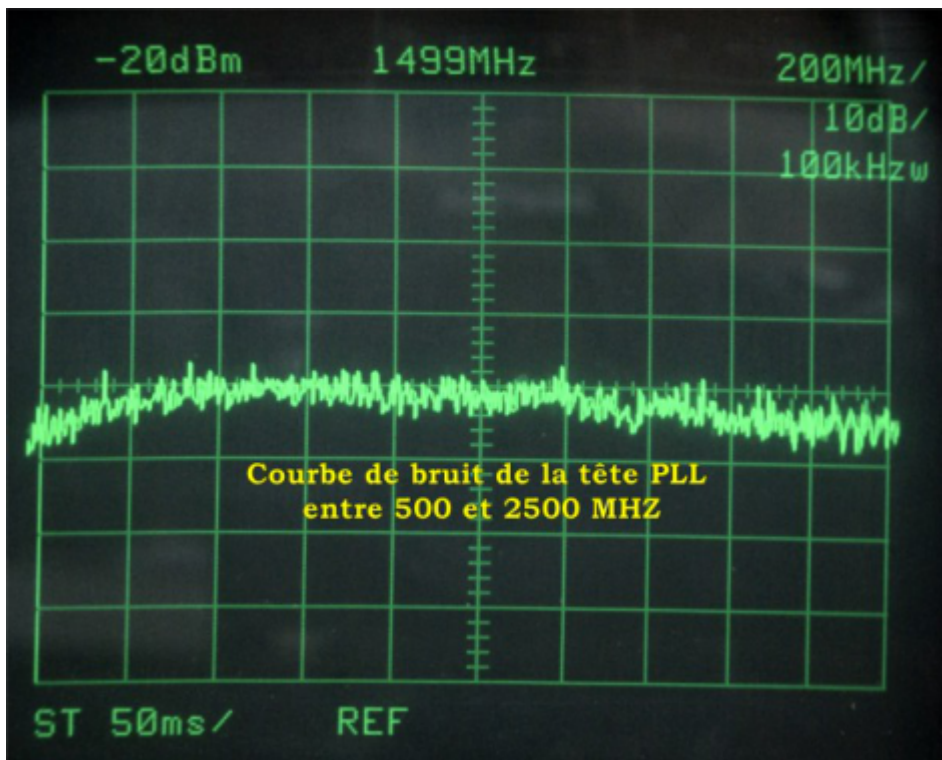



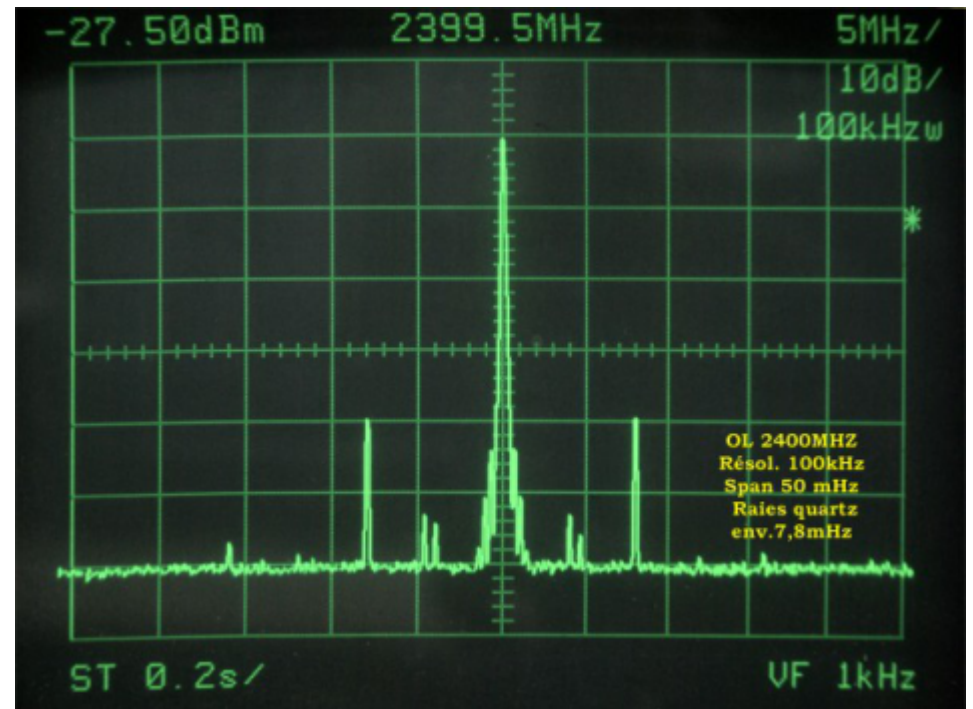
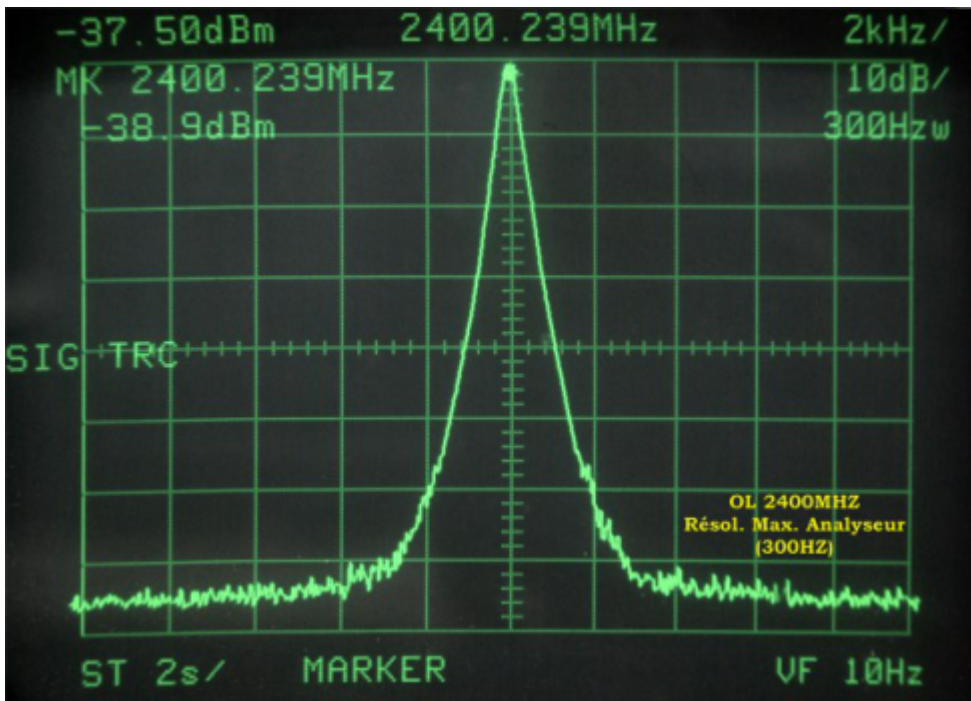
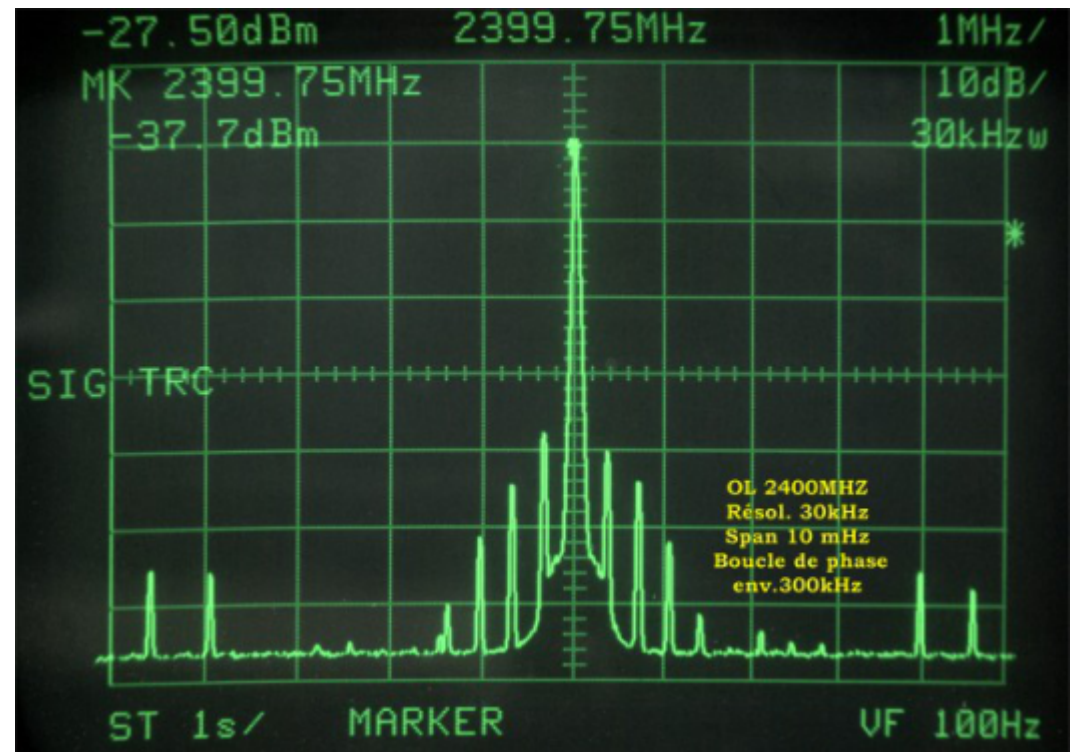
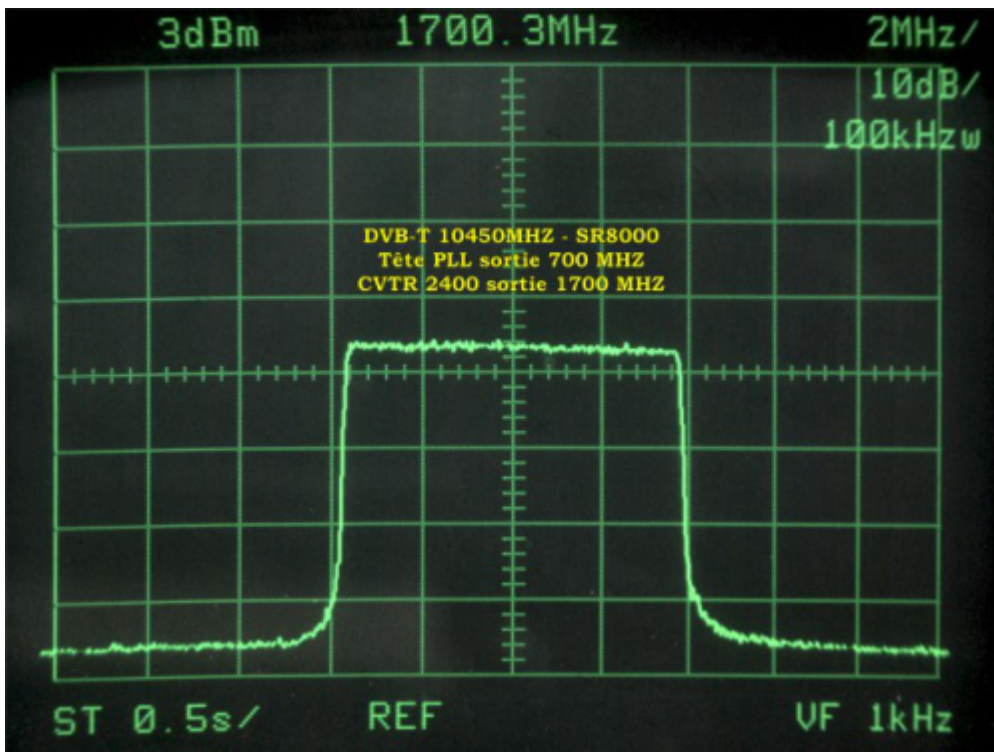

## Stability:

With recycling the beacon of the first space station Symphony in 1975, which is about 10590 MHz (quartz 110.3125) and outputs 18 dBm, I put an attenuator on the output, and listened to the output head Avenger PLL with AOR3000 scanner SSB, firstly directly on 840 mHz, and secondly, still in SSB, but with additional converter 2400 thus received on 1560 mHz.

Attached are two recordings in MP3 from this experience:  
[LNB single](#), [LNB + SUP-2400](#)

**Marc Chamley F3YX**

**TO BE CONTINUED.....**

-----

**Don't miss another issue! Subscribe Today**

**USA \$20.00 year Canada \$22.00 year DX  
\$29.00 year (US \$) Cyber: \$15/yr. Visa, M/C,  
AMEX, PayPal via Internet:**

[www.atvquarterly.com](http://www.atvquarterly.com)

**Cheques or Money Orders to P.O.Box 1594  
Crestline CA 92325**

**Published by ATV Quarterly tel (909) 338-  
6887 email: [wa6svt@atvquarterly.com](mailto:wa6svt@atvquarterly.com)**

Fall 2014  
Volume 27 - No 4  
ISSN 1042-198X  
USPS 003-353  
SINGLE ISSUE  
\$6.00 USA  
\$7.00 CANADA  
\$9.00 ELSEWHERE

# Amateur Television Quarterly

**AGC Video Processor**

**Manufacturing a Triband Dish Feed**

**Summer ATV-DATV DX**

**TriplePIC SSTV Receiver Pt. 2**





## Has USA selected a DATV Protocol yet?

### A short report by Ken Konechy W6HHC

Mark G7LTT recently posted a good question to the Yahoo Group forum on DigitalATV. Mark asked: "Have we settled on a DTV standard for ham use here in the US yet?"

My response to Mark and the Yahoo forum was:

I am not sure that there is a clear answer in USA yet? Certainly there is a lot of DVB-S in Europe and USA. Since HiDes started shipping low-cost DVB-T units in early 2014, there has been a lot of sales and "ham buzz" about DVB-T, but I do not have sales numbers for HiDes US sales. Each protocol has a set of "strengths and weaknesses" that a potential buyer needs to sort through. I tried to list below in order of importance:

### Protocol Tradeoffs

1) Compatibility with nearby repeater (choose the protocol being used by that nearby repeater so you have someone to talk with).

2) Hams like low-cost solutions. HiDes probably has lowest costs for (MPEG-encoder)+(DVB-T-exciter)+(DVB-T-receiver).

I estimate for DVB-T (have not thoroughly researched) HiDes at UT100B (Tx/Rx) about \$230 on e-bay + needs notebook computer availability.

I estimate for DVB-S (have not thoroughly researched) used Hauppauge video-capture about \$75 on e-bay + DATV-Express at \$300 + used DVB-S STB about \$60 + needs notebook

3) DVB-S probably has more signal robustness than DVB-T because less average power due to using COFDM by DVB-T and higher C/N (signal to noise ratio) required by DVB-T if using 16-QAM or 64-QAM modulation. See this terrific graph of C/N differences below that Grant ZL1WTT shared with this forum.

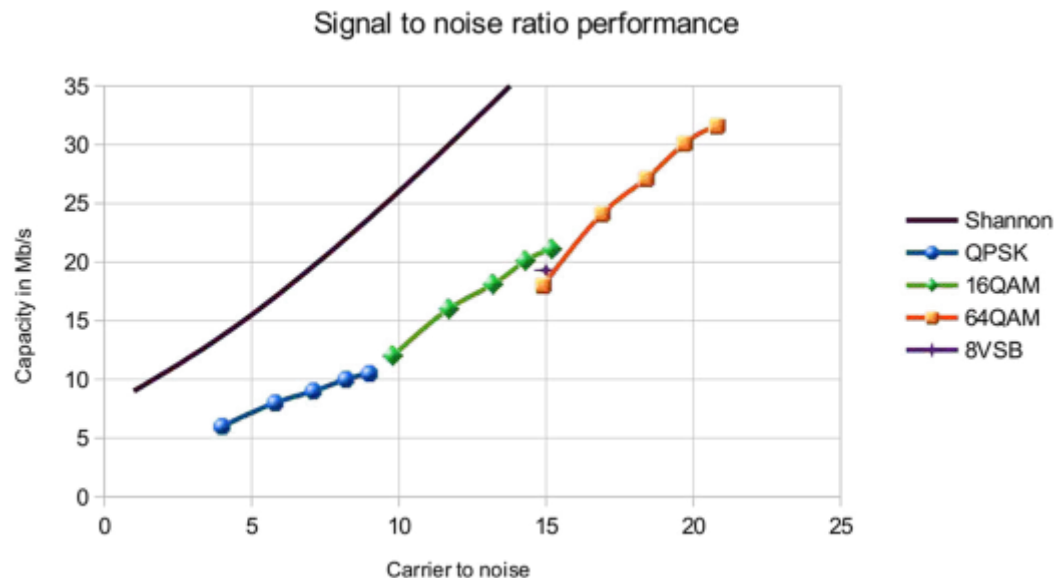

4) DVB-T will always achieve a lower average RF power output level from a given RF amplifier than with DVB-S with QPSK modulation. A lot of hams write this off as needing a "more linear amplifier", that may be true, but I see the real reason being that DVB-T creates a larger ratio of higher peak-power-spikes to average-power. The peak-to-average ratio is higher than for DVB-S.

Charles G4GUO explains it to me as the constantly-changing phasing of the 1700 subcarriers used by DVB-T creates these very high power spikes. To reduce spectrum noise, you have to reduce the power drive with DVB-T so that no compression is occurring on the peak power spikes being generated. Seems like a waste of a lot of good RF amplifier capability to just leave amplifier-headroom for the peak-power-spikes.

In discussions on this Yahoo Forum back mid-February ([DigitalATV] Learning about DVB-T average output power vs DVB-S) there were discussions of over 10 dB differences for average output levels from same RF amp.

5) There is a lot of experimenting with ham narrow-bandwidth DATV occurring in Europe (see BATC Forum for many threads).

Many European hams are trying to achieve a usable DATV BW of only 0.5 MHz using DVB-S. This need is being created by loss of ham spectrum space and trying to use a smaller signal-bandwidth to fit into crowded band plans. DVB-S receivers can typically go down below 1 MHz BW.

I believe that HiDes receivers are currently limited to 2 MHz channels, although I have heard discussions that HiDes will ship a 1 MHz BW DVB-T receiver model soon?

I am currently playing with H.264 video encoding being used with DVB-S protocol. Using more the effective MPEG-4 video encoding. I hope to be able to reduce my DVB-S RF bandwidth (using Standard Definition resolution) from 3.0 MHz down to about 1.5 MHz.

6) Finally, there is a lot of "buzz" from the DVB-T users about having the capability for HDTV transmissions. That is true, but HD signals also create a need for larger bandwidths and/or less-robust modulations.

Needing larger bandwidths seems to fly in the face of crowded spectrum-band-plans here in US. Personally, I have never appreciated the need for HD just to have hams transmit "talking heads" to their club members on the local DATV repeater.

**Please note that the map is relevant to commercial DVB television and not directly applicable to ham radio DATV.**

I am aware of two DVB-S repeaters and three DVB-T repeaters currently active in the USA.

### DVB-S

- *WR8ATV in Columbus, OH (ATCO group)*
- *KD6ILO/R1 in San-Diego/Del-Mar/, CA (SDDM-ATV Group for CERT and SART emergency communications)*

### DVB-T

- *WR8ATV in Columbus, OH (ATCO group)*
- *W6ATN in Los Angeles basin (Amateur Television Network)*
- *W8BI in Dayton, OH (still under various construction phases by DARA Club)*

The Orange County repeater that Robbie KB6CJZ and I are working on will use a DVB-S uplink on 1.262 GHz and a DVB-S downlink on 3.4 GHz.

If anyone is aware of additional active DATV repeaters in US, please contact me at: [W6HHC@ARRL.net](mailto:W6HHC@ARRL.net)

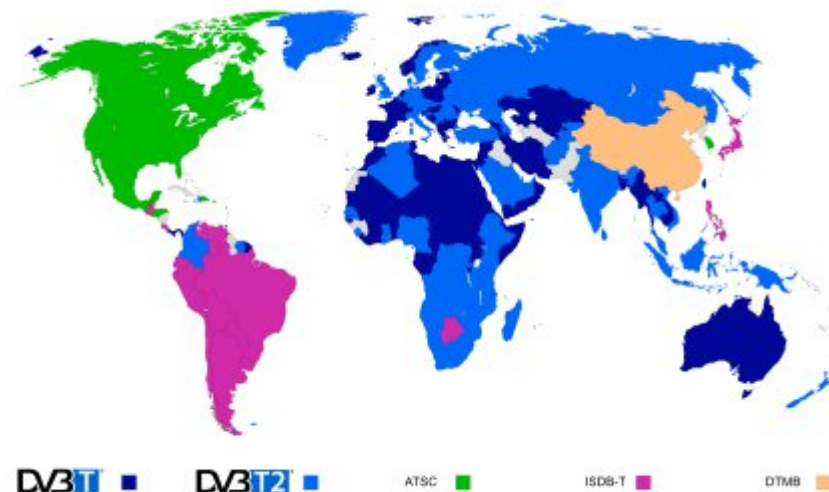

Digital Television Television Systems. Blue indicates countries that have adopted or adopted DVB-T and DVB-T2. December 2014  
Copyright © 2012 DVB Project. DVB and the DVB logo marks are registered trademarks of the DVB Project.



## To PC or not to PC, that is the question

Back in November last year, I realised that the next issue, 18, would be the last one before the holiday period so I decided to create a cover that reflected this time of the year. My design is shown at right.

However, this design did not suit the 'Politically Correct' police. Firstly I changed the text from '*..what will be in your stocking..*' to what you see below. However, this still did not pass the PC police.

Comments like...

*I think need to ask if we are happy with the young lady on the front cover, yes it brightens up our publication, but it does not match the content and is miss-leading. I also worry that for a world magazine it might offend some of our readers, or downloading it might be a punishable offence in some parts of the world.*

However, not all were in favour...

*All this "political correctness" crap has gone way too far.*

So, dear reader, what is your opinion? Was I right in bowing to the PC pressure, or should I have stuck to my guns and used the cover that I had designed. Please send any opinions/comments to [editor@cq-datv.mobi](mailto:editor@cq-datv.mobi). Thanks.

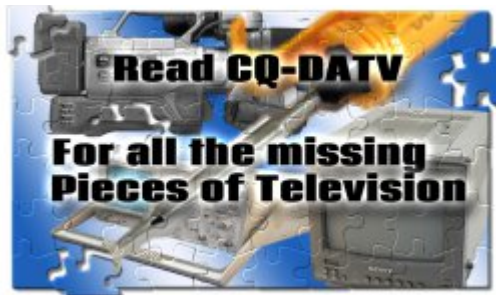

# CQ-DATV

dotMOBI



## Issue 18



## December 2014

*...what will be  
under your tree?..*

<http://cq-datv.mobi>

### External links

If you have an eBook reader that does not have WiFi then you will not be able to use the hyper-links in this publication. If you have an eBook reader that has WiFi then you will be able too providing you are in a WiFi zone.

But if you have a Kindle 3G then yes, but only to Amazon, and there is not a lot of ATV material on their site.

Smart phone reading apps are ok providing that you have a 3G data connection.

Note: These links will fire up your devices browser and if you are using 3G/4G then you will incur data usages charges.

### Legal Niceties (the small print)

E&OE. Whilst every care is taken in the production of this publication, dotMOBI accepts no legal responsibility for the advice, data and opinions expressed. dotMOBI neither endorses nor is it responsible for the content of advertisements or the activities of those advertisers. No guarantee of accuracy is implied or given for the material herein. dotMOBI expressly disclaims all liability to any person in respect of anything and in respect of the consequences of anything done or omitted to be done wholly or partly in reliance upon the whole or any part of this publication.

As the regulations for the operation of radio frequency equipment vary in different countries, readers are advised to check that building or operating any piece of equipment described in dotMOBI will not contravene the rules that apply in their own country.

All copyrights and trademarks mentioned in this publication are acknowledged and no infringement of the intellectual copyright of others is intended.

### Copyright

The articles contained in this publication remain the copyright of their respective authors and NOT dotMOBI. Any reproduction of such articles must be approved by the author of that article.

### Notice to Contributors

Authors are alone responsible for the content of their articles, including factual and legal accuracy, and opinions expressed by them may not reflect the editorial stance of the publication. Material submitted to dotMOBI should not infringe the copyright of other writers or bodies.

Contributions are accepted for publication on this basis alone. dotMOBI publications - <http://cq-datv.mobi>

### Author Guidelines

CQ-DATV welcomes contributions from our readers. It does not necessarily have to be on ATV, as long as it is of interest to our readers.

Although a formatted article showing the layout can be sent, we prefer an unformatted text file of the script, along with annotations of where important images should be placed. All images should be identified as Fig 1 etc and sent seperately.

Images should be in PNG format if possible and the best quality available. Do not resize or compress images, we will do all the rework necessary to publish them.

If you are sending a construction project, please include the dimensions of any pcb's and make the pcb image black and white, not greyscale.

CQ-DATV reserves the right to redraw any schematics and pcb layouts to meet our standards.



Is this the latest issue of CQ-DATV? [Click here](#) to go to our web site to check to see if there is a later edition available.



# British Amateur Television Club

**The club provides the following for its members:**

- A colour magazine, CQ-TV, produced for members in paper or .pdf (cyber membership) formats.
- Web site – where you can find our online shop stocking hard to get components, software downloads for published projects and much more.
- A members forum at [www.batc.org.uk/forum/](http://www.batc.org.uk/forum/) for help, information and the interchange of ideas.
- A video streaming facility at [www.batc.tv](http://www.batc.tv) which enables repeaters and individual members to be seen worldwide.
- An annual Convention held in the UK where you can meet other members, visit demonstrations and listen to lectures.
- Meet other club members at the BATC stand at local rallies across the country.

[www.batc.org.uk](http://www.batc.org.uk)





# CQ-DATV

dotMOBI 



**Like us on Facebook**



**CQ-DATV**  
dotMOBI  
**Issue 20-February 2015**



<http://cq-datv.mobi>