

**INSTALLATION
AND
OPERATING
INSTRUCTIONS
FOR...**



**MODEL S-40A
RADIO RECEIVER**



the hallicrafters CO.



A Subsidiary of Northrop Corporation

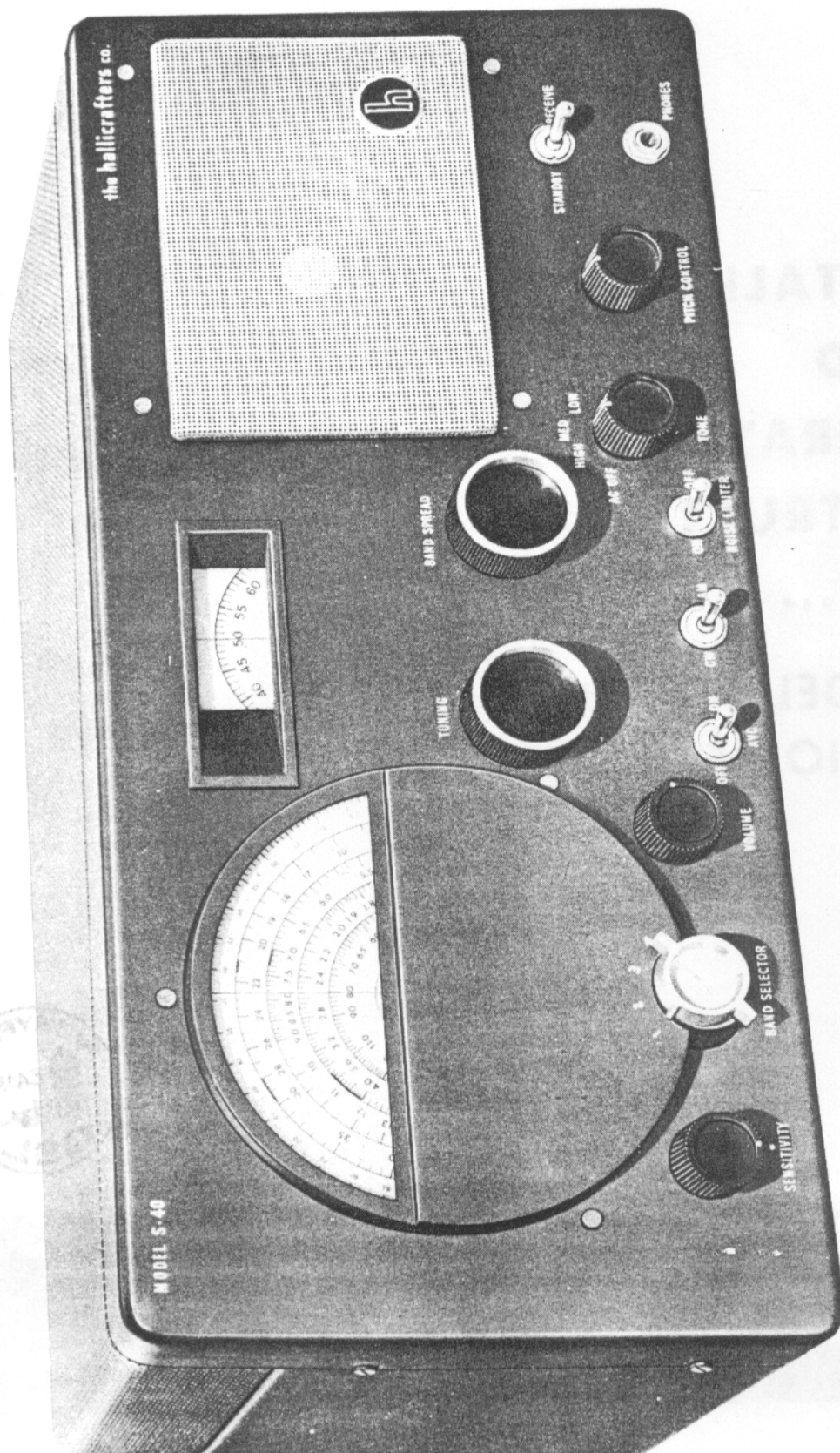

Figure 1. Radio Receiver Model S-40A, AU, front view.

**INSTALLATION AND OPERATING
INSTRUCTIONS
FOR
RADIO RECEIVER MODEL S-40A, AU**

GENERAL.—Your receiver is a table model, superheterodyne radio receiver capable of receiving standard broadcast and foreign or domestic short wave stations over four frequency ranges with continuous coverage provided from 540 kc (kilocycles) to 43 mc (megacycles). A bandswitch is provided for selecting the four ranges of reception which are indicated on the attractively illuminated main tuning dial scale. The amateur bands as well as foreign station locations are also clearly indicated on the main tuning dial scale as a convenient reference for radio amateurs (hams) and also the short wave listener. On the main tuning dial scale is also located a logging scale which is used as a reference when logging radio stations. A band spread dial is provided for fine tuning of short wave stations, the use of which is described later in these instructions. Special features are provided to improve reception such as automatic noise limiter and volume control. Provision is made for the optional use of a headset. A beat frequency oscillator (b.f.o.) is provided for code reception, this feature being especially useful to the radio amateur and code enthusiast.

The S40A receiver is designed to operate from a 105 to 125-volt, a-c, 50/60 cycle source and requires 75 watts of power for operation. The S40AU receiver is designed to operate from a 110 to 250 volt a-c, 25 to 60 cycle source and requires 75 watts of power for operation. A switch is located on top of the transformer for adjusting the transformer to the proper voltage source. Connection to the power source is made by the two prong plug which is attached to the six foot line cord extending from the rear of the cabinet. On the rear of the receiver chassis is provided a socket for connecting to a d-c source of power such as a 6-volt storage battery and "B" batteries or vibrapack.

Another socket is provided on the rear of the receiver chassis for the connection of an external tuning meter which is available for this model.

The complete receiver is 9 inches high by 18½ inches wide by 11 inches deep and weighs 28 pounds.

The maximum output of the receiver at the speaker is one watt with less than ten percent distortion.

MECHANICAL DESCRIPTION.—The model S-40 radio receiver is housed in an attractive, well ventilated aerodized sheet metal cabinet to minimize electrical interference and provide mechanical strength. The full length aerodized top cover, mounted on a piano type hinge, provides a means of gaining access to all of the tubes, dial lamps and i-f transformer adjustments. Mixer and oscillator adjustments may be made from the bottom of the cabinet through the holes provided for this purpose under the notice card. Three small holes on the bottom near the front of the cabinet provide access to the oscillator padder adjustments. All controls for tuning and operating are located on the front of the receiver. Notice that some of the control markings are in red. This is to aid the novice in operating the receiver.

ELECTRICAL DESCRIPTION.—The block diagram, Figure 2, illustrates the function of the receiver circuits in a simple manner which is described as follows: radio signals are picked up at the antenna and fed to the antenna coil of the r-f stage where the desired station signal is selected by a resonant circuit and fed to the mixer-oscillator tube.



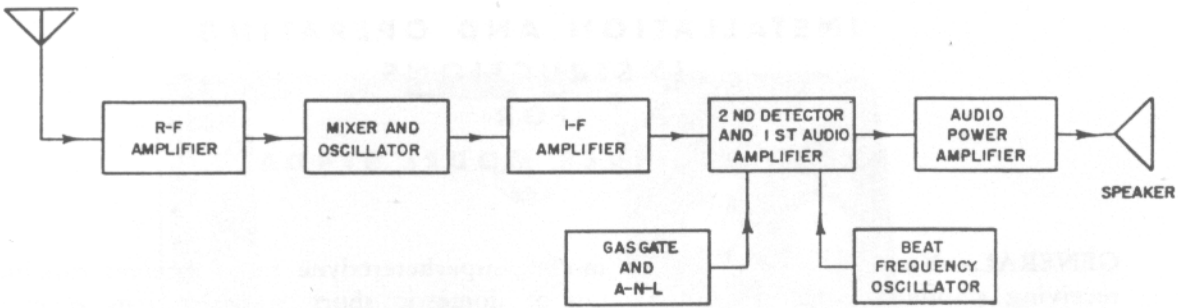

Figure 2. Radio Receiver Model S-40A, AU, block diagram showing receiver circuits.

At the same time the oscillator section of the mixer-oscillator tube generates a local r-f signal which is mixed with the selected incoming station signal. An intermediate frequency signal of 455 kc (kilocycles) is selected by the first i-f transformer and fed through two i-f amplifier stages to the detector-first audio amplifier stage where it is then demodulated. The audio component of the i-f signal is amplified by the triode section of the detector-first audio amplifier tube and then capacity coupled to the audio power output tube where it is further amplified and fed to the speaker.

The a-v-c circuit is a conventional one which provides a uniform signal level when listening to music or voice (phone) broadcasts. It is in use with the AM/CW switch at the AM position.

The beat frequency oscillator stage operates in the CW position of the AM/CW switch and provides an r-f signal at 455 kc (kilocycles) which is fed to the detector stage to beat against the i-f signal, thereby rendering code signals intelligible. The pitch of the code signal can be varied by means of the CW-PITCH control which permits a variation from 0 to 1,000 cycles.

The automatic noise limiter circuit employs one diode of a duo-diode type tube (6H6), the other diode being used as an electronic bleeder (gas-gate) for the tubes which are a-v-c controlled in the event that any one or all of these tubes should become gassy.

A power rectifier stage provides a well filtered source of high voltage to the plate and screen circuits when the receiver is operated from an a-c source.

INSTALLATION OF THE RECEIVER

1. As soon as the receiver has been unpacked, examine it for any apparent damage which might have occurred in shipment. If any damages are found, file a claim IMMEDIATELY with the transportation company. If purchased packed "over the counter" and any defects or damages are apparent after the receiver has been unpacked, return it IMMEDIATELY to the dealer. If purchased "unpacked" over the counter, examine carefully and thoroughly for any possible defects, BEFORE ACCEPTANCE.

2. Fill out and immediately mail the record return card which is enclosed with these instructions.



3. This receiver is equipped with rubber mounting feet for mounting on a table or other piece of furniture. Do not mount this radio on a radiator or any area subject to heat or humidity.

4. An external antenna should be connected to the receiver as follows:
On the rear apron of the receiver chassis is located the antenna connector strip, marked A1, A2 and G. Select one of the antenna systems described below and connect it to the strip as directed.

An external ground connection is not essential to this receiver, but in some locations will help to improve reception especially on the higher frequencies. If it is desired to use an external ground, always connect it to the terminal marked "G" on the antenna terminal strip.

A. *Single Wire Antenna.*—When using a single wire antenna installation, connect a jumper between the antenna terminal A2 and G. Then connect a single wire of about 50 to 75 feet (including lead-in) to terminal A1. Use #14 gauge copper wire or heavier for best results. Erect the antenna as high and free from surrounding objects as possible. This type of antenna works well where the signal to noise ratio is relatively high and a more elaborate installation is not practical. Refer to Fig. 3.

B. *Doublet Antenna.*—This type of antenna is recommended where the receiving conditions are poor or where maximum sensitivity is required over a relatively narrow range of frequencies. The lead-in wires should be connected to terminals A1 and A2. If a concentric line with grounded outer conductor is used, connect the inner conductor to terminal A1, the outer conductor to terminal A2 and connect a jumper between terminal A2 and G.

(1) To determine the proper length of the doublet antenna in feet:

(a) Determine the frequency range to which you wish to listen.

(b) Divide 468 by the frequency (in megacycles) of the high frequency end of the range you selected.

(2) To prepare the antenna for installation:

(a) Measure the wire to the length determined in step (b) above and insert an insulator at that point.

(b) Wrap and solder the two wires of the lead-in to each of the quarter-wave sections at the insulator as shown in Figure 4.

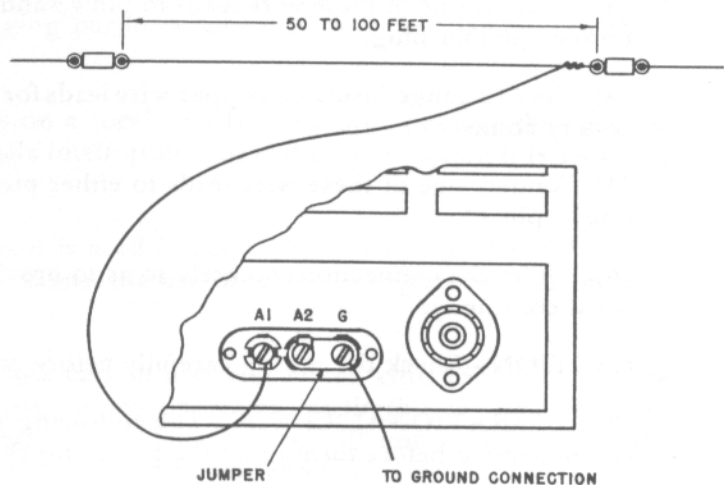

Figure 3. Single Wire Antenna Installation.

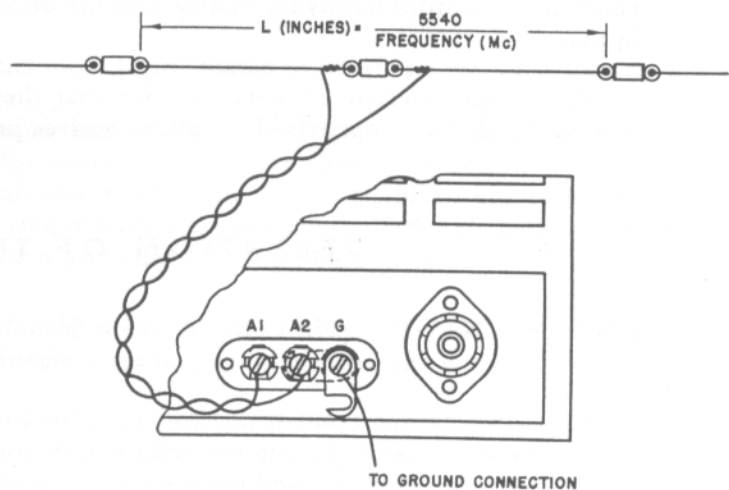

Figure 4. Doublet Antenna Installation.



Keep in mind that this type of antenna is directional broadside to its length and should be so orientated if maximum pick-up from a given direction is desired.

For reference to other types of antennae refer to the latest edition of the Radio Amateur's A.R.R.L. Handbook, section on antennas. This book can be procured from most dealers of radio amateur "ham" equipment.

D-C OPERATION.—This receiver may be operated from a 6-volt d-c source, generally a storage battery, and 270-volts d-c supply in the form of dry batteries or vibrator type power pack. The filament current drain in this case will be about 5 amperes, while the "B" current will be about 70 milliamperes. The 6-volt battery drain using a vibrator supply for "B" voltage will run approximately 10 amperes. The receiver is connected to the d-c supply as follows:

- (1) Remove the octal "jumper plug" used for a-c operation from the socket at the rear of the chassis.
- (2) Use #18 gauge insulated copper wire leads for the 260-volt "B" supply connections and—
- (3) Connect one of these wire leads to pin #3 and one to pin #5 on the "jumper plug."
- (4) Use #12 gauge insulated copper wire leads for the 6-volt "A" battery connections and—
- (5) Connect one of these wire leads to either pin #1 or #8 and one to pin #7.
- (6) Solder the connections securely so as to provide good electrical continuity.

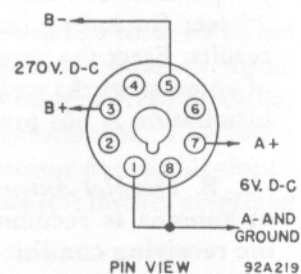

Figure 5. Wiring diagram for d-c power plug.

CAUTION—Check the wiring carefully before connecting up to the battery supply.

PRE-OPERATIONAL CHECK—The following checkup on a newly installed receiver is recommended before turning on the power for the first time.

- (1) See that the tubes are securely seated in their sockets. Refer to Figure 7 for the proper location of each tube.
- (2) Check the pilot lamps located behind the dial escutcheons and see that they are securely in place.
- (3) Check all external connections. See that they are secure and make positive contact. Remember that an improvised installation gives improvised results.

OPERATION OF THE RECEIVER

EXPLANATION OF THE CONTROLS.—Scanning across the front of the receiver from left to right, the control markings and an explanation of each is as follows:

NOTE.—Some of the control markings are in RED. This is an added feature incorporated for the convenience of the listener who is not familiar with radio terminology as an aid in setting the controls most used for the reception of standard broadcast stations.

Reference to Figure 6 will help the listener in becoming familiar with the use of the controls.



1. SENSITIVITY control.—This control regulates the sensitivity of the receiver. Turning the control clockwise increases the sensitivity of the receiver. Ganged to this control is the "S" meter switch which connects the tuning meter, when one is used, into the circuit when the control is advanced maximum clockwise.
2. BAND SELECTOR switch.—This switch selects the desired band or frequency range for the listener. The frequencies covered by each band switch position are read directly from the main tuning dial. Position #1 (in red) is the standard broadcast band. Each range has sufficient overlap to provide continuous coverage over the overall tuning range of the receiver.
3. VOLUME control.—This control sets the audio level at the speaker and is to be set for the level of volume most pleasing to the listener.
4. A.V.C. switch.—This switch, when set at "ON," provides a constant audio output level over reasonable variations in signal strength at the antenna, i.e. it automatically controls the sensitivity of the receiver when this circuit is in operation. This switch must be set at ON to use the tuning meter, when one is used.
5. Main TUNING control.—This control tunes the receiver to the desired frequency of reception which is read on the main tuning dial located to the left of the control. The outer scale on the dial may be used for logging purposes which is described later on in these instructions.
6. AM/CW switch.—This switch turns on a local oscillator used to produce the beat frequency necessary for making code signals intelligible. For ordinary reception it is set in the AM position.
7. BAND SPREAD tuning.—This control is used in conjunction with the main TUNING control for fine tuning of short wave stations, the use of which is explained later in these instructions.
8. NOISE LIMITER switch.—This switch cuts in a circuit which clips the noise voltage peaks generated by electrical disturbances, thereby providing intelligible reception in cases where reception would normally be impossible. This feature will not totally remove the noise but will do a good job of limiting it to a reasonable level.
9. TONE control.—This control adjusts the tone qualities of the audible signal for either speaker or headset and also includes a switch which turns the A-C power ON or OFF. The types of response available are—LOW, MED. and HIGH. In the A-C OFF position the power to the receiver is disconnected.
 - (a) LOW—The bass and high frequencies are attenuated to provide a response for voice frequencies only.
 - (b) MED.—The bass and high frequencies are attenuated somewhat less than for the LOW position providing a response for more than the ordinary voice frequencies. This position is preferred for voice communications when the signal to noise ratio will permit.
 - (c) HIGH—The bass and medium frequencies are attenuated in favor of the high audio frequencies providing good response for high audio frequency response.
10. PITCH control.—This control is used to vary the pitch of the code signal when listening to amateur or commercial code stations.
11. STANDBY-RECEIVE switch.—This switch disconnects the d-c voltage from the receiver while leaving the tube heaters at operating temperature, thus leaving the receiver in condition for instant use. This switch is used by the radio amateur "ham" to put the receiver in a standby condition when transmitting. For the general listener it provides a means of putting the receiver in an inoperative condition ready for instant use.



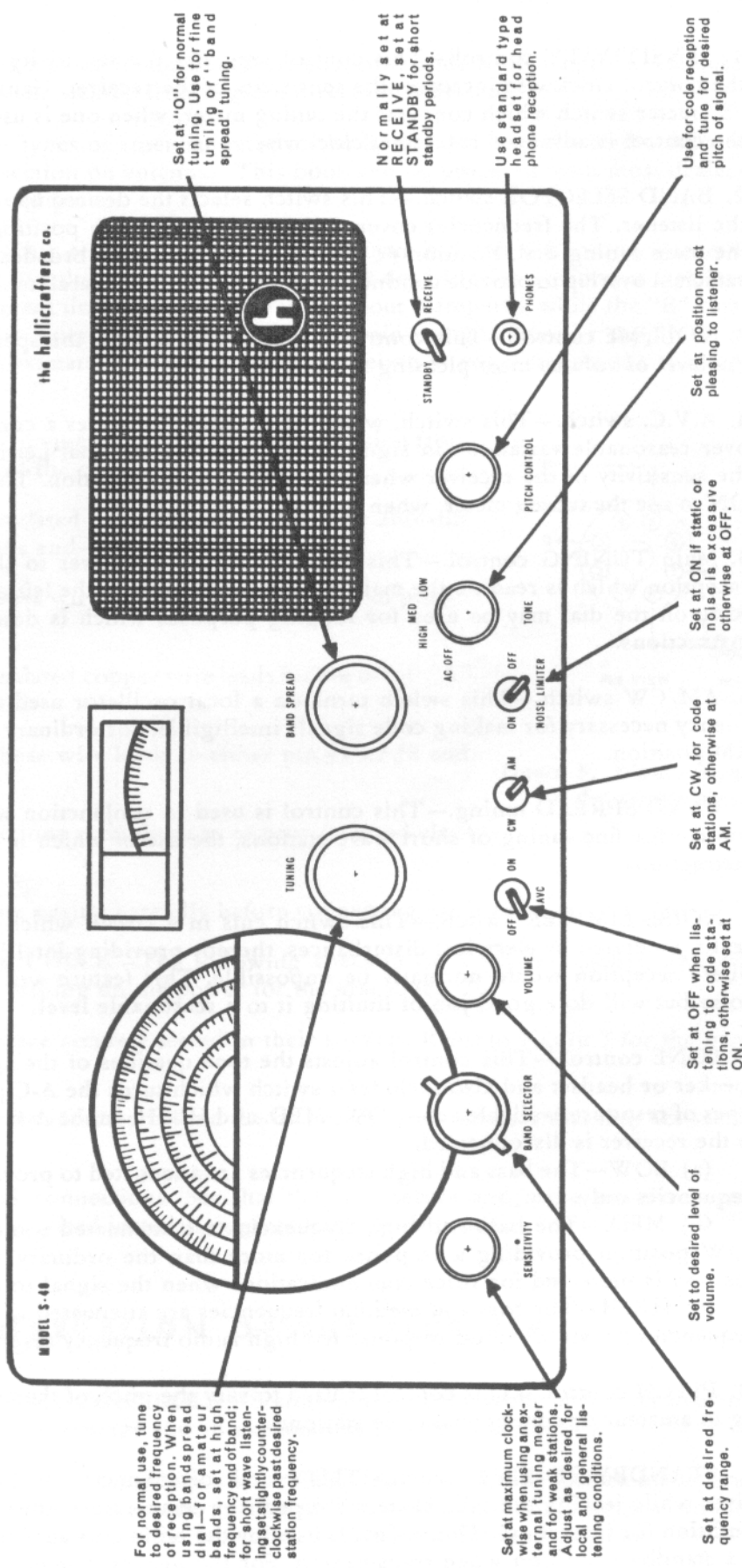

Figure 6. Radio Receiver Model S-40A, AU, view showing use of controls.

BAND SPREAD TUNING

FOR THE "HAM."—To use the band spread dial, set the dial pointer at "O," set main tuning dial pointer at the high frequency end of the range to be covered and tune in the stations with the BAND SPREAD tuning control. Example:—Assume you wish to listen in on the 10 meter band. Set the BAND SELECTOR at position 4 (15.7 to 43 mc), set main TUNING dial pointer at 30 mc (megacycles), the high end of the 10 meter band, and then set the band spread dial pointer at "O." You can now listen in on the 10 meter band by tuning with the BAND SPREAD tuning control. The preceding example holds true for any of the frequency ranges, although the higher in frequency is the range of tuning, the narrower will be the range of tuning on the band spread tuning dial scale. Band spread tuning is not necessary on the broadcast band.

FOR THE SHORT WAVE LISTENER.—To tune in short wave broadcast radio stations with the band spread tuning control, set the band spread dial pointer at "O", set the main tuning dial pointer counterclockwise slightly past the frequency of the station you wish to tune in and then tune in the station with the BAND SPREAD control.

IMPORTANT.—The calibrations on the main tuning dial scale are only correct when the BAND SPREAD dial pointer is set at "0."

OWNER'S MAINTENANCE

PREVENTIVE MAINTENANCE.—Keep the various parts of the receiver clean, especially the tuning capacitors. Dust and dirt should be blown out with dry air or brushed out carefully without bending the capacitor plates in the slightest. Noisy reception may be also caused by dirty condenser wipers, faulty volume controls, switches and tubes, etc. in the receiver. Check the switch contacts and controls and make sure that all tubes are always in their sockets.

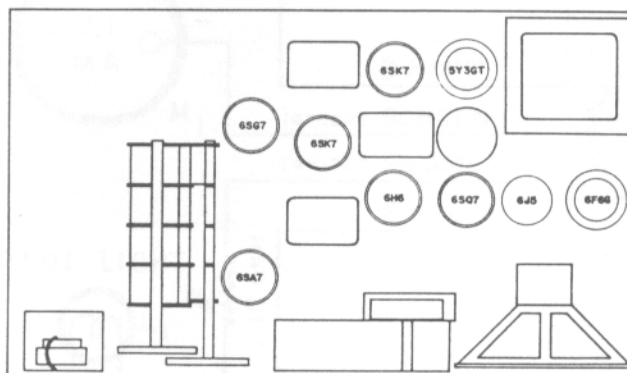

Figure 7. Radio Receiver Model S-40A, AU, view showing tube locations.

REPLACING TUBES AND DIAL LAMPS.—When replacing tubes, check the tube type carefully and replace with the correct type. Refer to the top of the receiver chassis, Fig. 7, to determine the location of each tube. The receiver employs two dial lamps with bayonet type sockets to illuminate the two dial scales. Replace these with similar types, 6/8 volt, 250 ma., "blue bead" G.E. #44 or equivalent. The color code referred to is the color of the glass bead above the glass stem inside the envelope of the lamp.

PERIODIC ADJUSTMENTS.—This receiver has been carefully aligned at the factory and should not require realignment until it needs new tubes in the r-f and mixer-oscillator stages or shows signs of loss in sensitivity, off frequency calibration or requires service work on these stages. Alignment should not be attempted by inexperienced persons as maximum performance is obtained only by intelligent alignment.

A complete service bulletin is available for use in servicing this receiver and can be obtained from any one of our distributors or dealers or by contacting the factory direct.



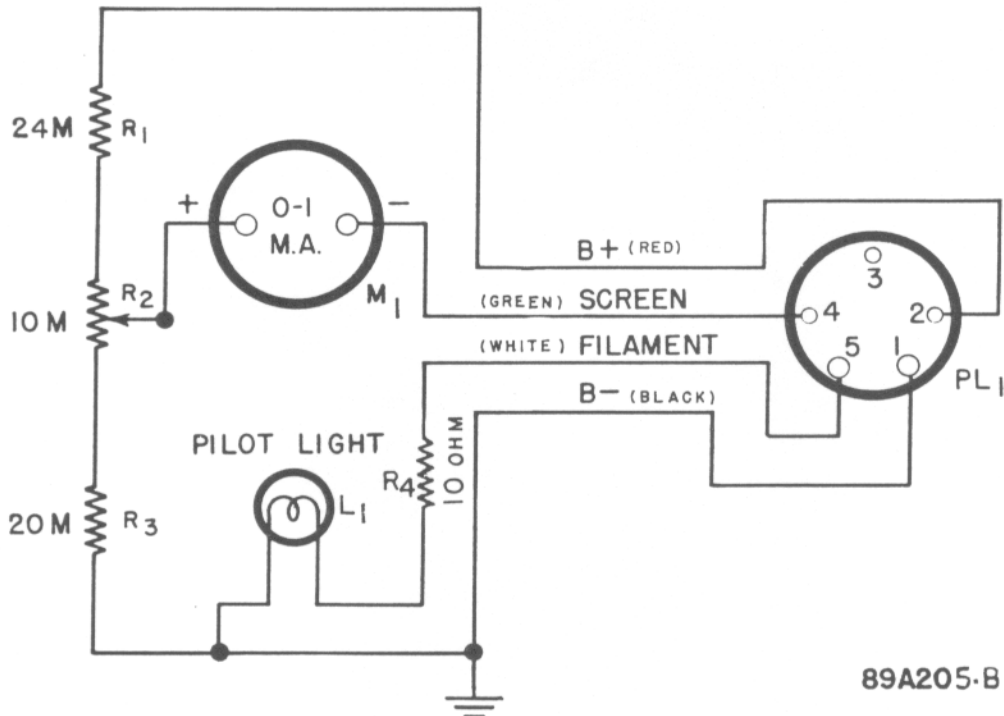
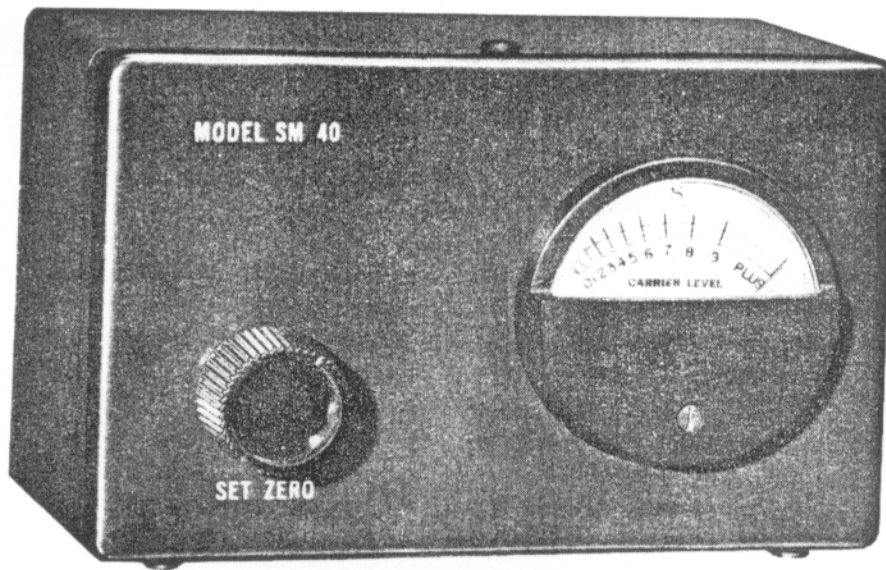

Figure 8. Tuning Meter SM-40 and schematic wiring diagram.

The meter is mounted in an attractive case to match the receiver cabinet. A zero adjust control is mounted at the front of the case for meter zero adjustment. Installation and adjustment instructions are supplied with the meter.

The tuning meter "S METER" is not supplied with the receiver, but can be purchased on request from the company. Provision has been made on the rear apron of the receiver for the external connection of the "S" meter. A five prong plug is wired to the meter as indicated in the above illustration and should be plugged into socket provided for this purpose. When metering reception, the meter measures a voltage drop across a resistor, i.e. a change in screen current of first and second i-f amplifier tubes.



WARRANTY

"The Hallicrafter's Company warrants each new radio product manufactured by it to be free from defective material and workmanship and agrees to remedy any such defect or to furnish a new part in exchange for any part of any unit of its manufacture which under normal installation, use and service discloses such defect, provided the unit is delivered by the owner to our authorized radio dealer, wholesaler, from whom purchased, or, authorized service center, intact, for examination, with all transportation charges prepaid within ninety days from the date of sale to original purchaser and provided that such examination discloses in our judgment that it is thus defective.

This warranty does not extend to any of our radio products which have been subjected to misuse, neglect, accident, incorrect wiring not our own, improper installation, or to use in violation of instructions furnished by us, nor extended to units which have been repaired or altered outside of our factory or authorized service center, nor to cases where the serial number thereof has been removed, defaced or changed, nor to accessories used therewith not of our own manufacture.

Any part of a unit approved for remedy or exchange hereunder will be remedied or exchanged by the authorized radio dealer or wholesaler without charge to the owner.

This warranty is in lieu of all other warranties expressed or implied and no representative or person is authorized to assume for us any other liability in connection with the sale of our radio products."

the hallicrafters co.
A Subsidiary of Northrop Corporation



092-014557B



094-000519B
1268

Printed in U.S.A.