

The RF Line NPN Silicon High-Frequency Transistor

The BFR96 transistor uses the same state-of-the-art microwave transistor chip which features fine-line geometry, ion-implanted arsenic emitters and gold top metallization. This transistor is intended for low-to-medium power amplifiers requiring high gain, low noise figure, and low intermodulation distortion. The BFR96 is particularly suitable for broadband MATV/CATV amplifiers.

BFR96

$f_T = 4.5 \text{ GHz @ } 50 \text{ mA}$
HIGH-FREQUENCY
TRANSISTOR
NPN SILICON

MAXIMUM RATINGS

Rating	Symbol	Value	Unit
Collector-Emitter Voltage	V_{CEO}	15	Vdc
Collector-Base Voltage	V_{CBO}	20	Vdc
Emitter-Base Voltage	V_{EBO}	3.0	Vdc
Collector Current — Continuous	I_C	100	mAdc
Total Device Dissipation @ $T_C = 100^\circ\text{C}$ (1) Derate above $T_C = 100^\circ\text{C}$	P_D	0.5 10	Watts mW/ $^\circ\text{C}$
Storage Temperature	T_{stg}	-65 to +150	$^\circ\text{C}$

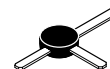

CASE 317A-01, STYLE 2

ELECTRICAL CHARACTERISTICS ($T_C = 25^\circ\text{C}$ unless otherwise noted.)

Characteristic	Symbol	Min	Typ	Max	Unit
----------------	--------	-----	-----	-----	------

OFF CHARACTERISTICS

Collector-Emitter Breakdown Voltage ($I_C = 1.0 \text{ mAdc}$, $I_B = 0$)	$V_{(BR)CEO}$	15	—	—	Vdc
Collector-Base Breakdown Voltage ($I_C = 100 \mu\text{Adc}$, $I_E = 0$)	$V_{(BR)CBO}$	20	—	—	Vdc
Emitter-Base Breakdown Voltage ($I_E = 100 \mu\text{Adc}$, $I_C = 0$)	$V_{(BR)EBO}$	3.0	—	—	Vdc
Collector Cutoff Current ($V_{CB} = 10 \text{ Vdc}$, $I_E = 0$)	I_{CBO}	—	—	100	nAdc

ON CHARACTERISTICS

DC Current Gain ($I_C = 50 \text{ mAdc}$, $V_{CE} = 10 \text{ Vdc}$)	h_{FE}	30	—	200	—
--	----------	----	---	-----	---

DYNAMIC CHARACTERISTICS

Current-Gain — Bandwidth Product ($I_C = 50 \text{ mAdc}$, $V_{CE} = 10 \text{ Vdc}$, $f = 0.5 \text{ GHz}$)	f_T	—	4.5	—	GHz
Collector-Base Capacitance ($V_{CB} = 10 \text{ Vdc}$, Emitter Guarded)	C_{cb}	—	1.2	1.5	pF

NOTE:

1. Case temperature measured on collector lead immediately adjacent to body of package.

(continued)

ELECTRICAL CHARACTERISTICS — continued ($T_C = 25^\circ\text{C}$ unless otherwise noted.)

Characteristic	Symbol	Min	Typ	Max	Unit
FUNCTIONAL TESTS					
Noise Figure ($I_C = 10\text{ mA}$, $V_{CE} = 10\text{ V}$, $f = 0.5\text{ GHz}$)	NF	—	2.0	—	dB
Maximum Unilateral Gain/Insertion Gain (2) ($I_C = 50\text{ mA}$, $V_{CE} = 10\text{ V}$, $f = 0.5\text{ GHz}$)	$G_{U(\text{max})}/ S_{21} ^2$	—/12	14.5/13	—	dB

NOTE: 2. $G_{U(\text{max})} = \frac{|S_{21}|^2}{(1-|S_{11}|^2)(1-|S_{22}|^2)}$

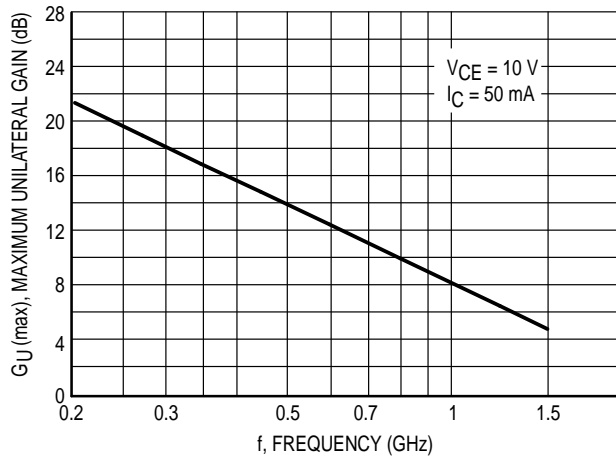

Figure 1. Maximum Unilateral Gain versus Frequency

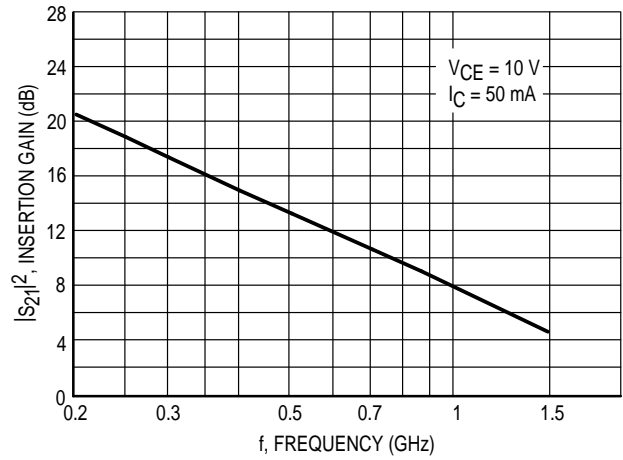

Figure 2. $|S_{21}|^2$ versus Frequency

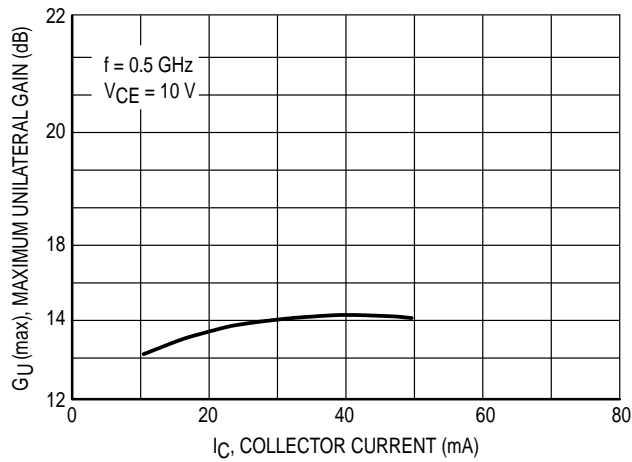

Figure 3. Maximum Unilateral Gain versus Collector Current

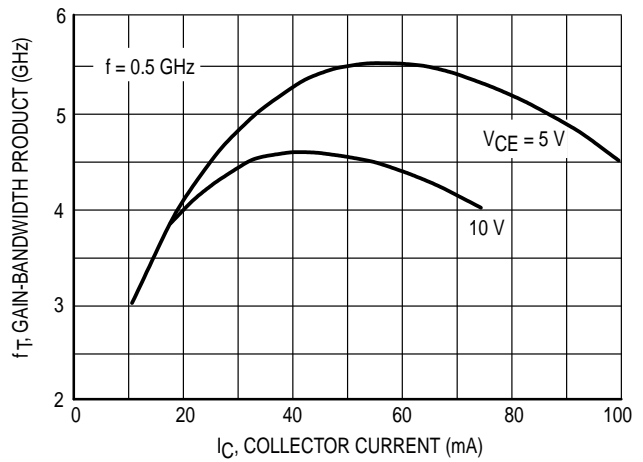

Figure 4. Gain-Bandwidth Product versus Collector Current

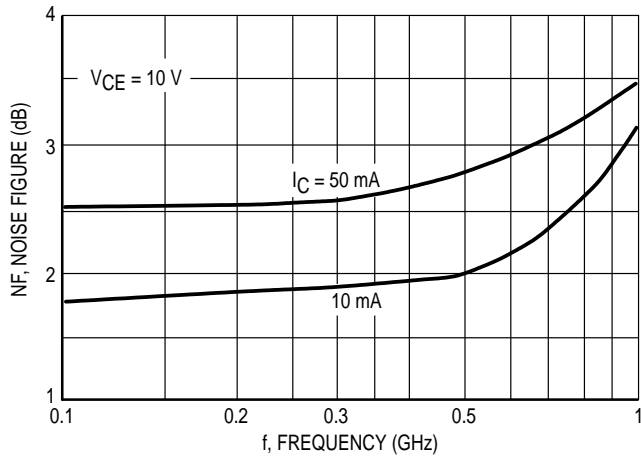

Figure 5. Noise Figure versus Frequency

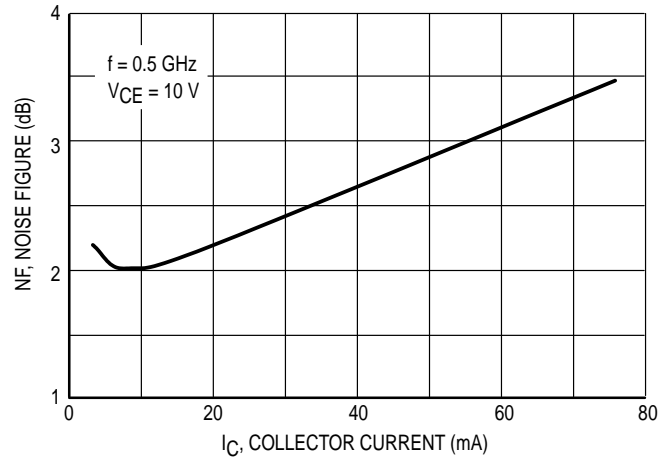

Figure 6. Noise Figure versus Collector Current

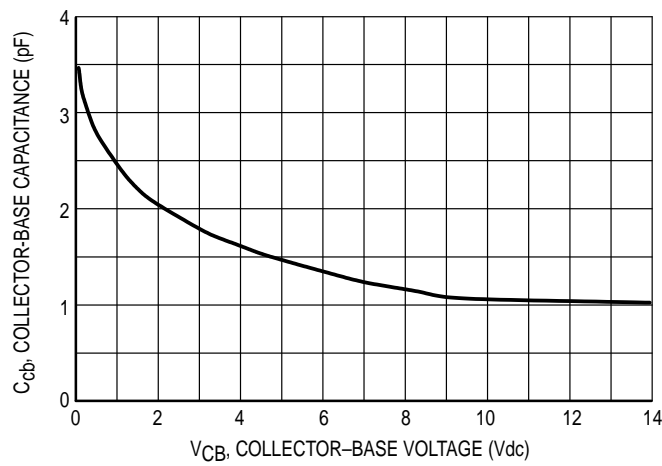

Figure 7. Collector-Base Capacitance versus Collector-Base Voltage

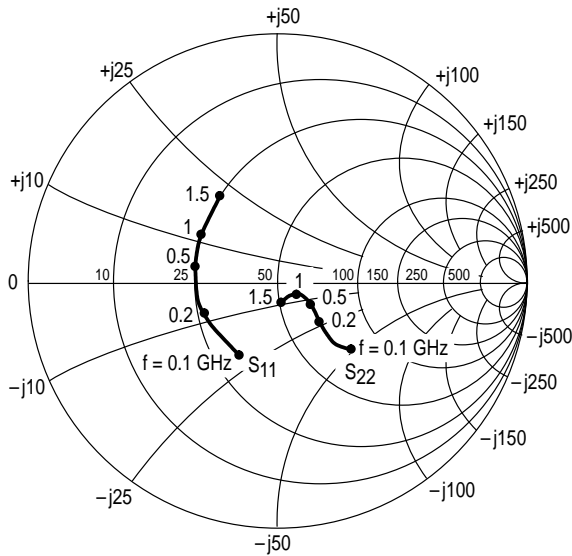

Figure 8. Input/Output Reflection Coefficients versus Frequency
($V_{CE} = 10\text{ V}$, $I_C = 50\text{ mA}$)

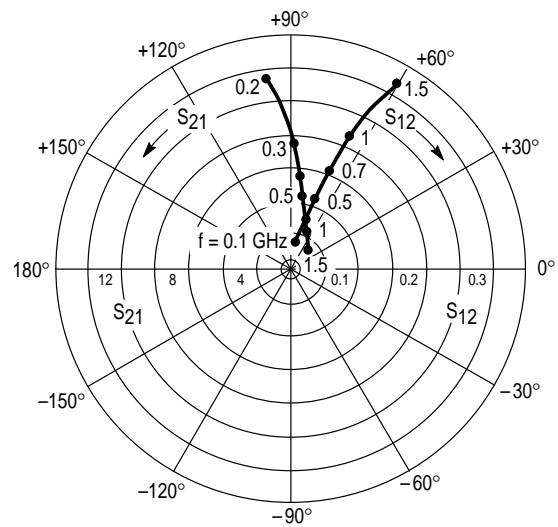
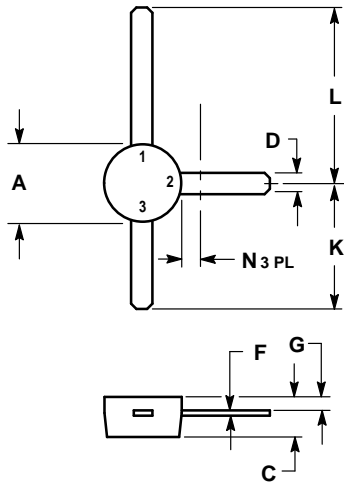

Figure 9. Forward/Reverse Transmission Coefficients versus Frequency
($V_{CE} = 10\text{ V}$, $I_C = 50\text{ mA}$)

V_{CE} (Volts)	I_C (mA)	f (MHz)	S_{11}		S_{21}		S_{12}		S_{22}	
			$ S_{11} $	ϕ	$ S_{21} $	ϕ	$ S_{12} $	ϕ	$ S_{22} $	ϕ
5.0	10	100	0.51	-95	15.04	121	0.047	54	0.58	-48
		300	0.43	-163	5.87	92	0.082	58	0.26	-63
		500	0.46	174	3.61	79	0.120	63	0.19	-63
		700	0.48	162	2.65	68	0.161	63	0.15	-64
		1000	0.48	146	1.92	57	0.220	63	0.12	-79
		1500	0.54	121	1.40	43	0.320	58	0.13	-118
	25	100	0.39	-122	19.41	112	0.037	60	0.42	-68
		300	0.39	-176	6.81	89	0.079	68	0.16	-94
		500	0.42	166	4.11	78	0.129	70	0.10	-103
		700	0.44	156	3.05	69	0.176	68	0.06	-119
		1000	0.44	142	2.20	59	0.244	64	0.06	-159
		1500	0.49	118	1.62	45	0.348	57	0.10	177
	50	100	0.35	-140	21.10	106	0.032	64	0.33	-81
		300	0.38	176	7.11	88	0.081	72	0.13	-116
		500	0.42	162	4.28	78	0.133	72	0.09	-136
		700	0.43	153	3.16	70	0.183	69	0.07	-163
		1000	0.42	140	2.28	60	0.252	65	0.08	165
		1500	0.47	116	1.66	47	0.357	57	0.12	155
10	10	100	0.53	-83	15.96	124	0.039	58	0.65	-36
		300	0.38	-154	6.44	94	0.070	59	0.35	-41
		500	0.41	-179	3.98	81	0.102	64	0.30	-39
		700	0.42	166	2.94	70	0.138	65	0.27	-39
		1000	0.42	151	2.12	60	0.191	66	0.24	-47
		1500	0.49	125	1.50	44	0.278	63	0.22	-72
	25	100	0.38	-104	20.85	115	0.032	60	0.48	-48
		300	0.32	-169	7.54	91	0.070	68	0.23	-48
		500	0.35	170	4.61	80	0.109	71	0.19	-43
		700	0.37	160	3.37	70	0.152	69	0.16	-39
		1000	0.37	146	2.43	61	0.210	67	0.13	-44
		1500	0.43	121	1.73	47	0.304	61	0.10	-74
	50	100	0.33	-119	22.59	109	0.029	63	0.39	-51
		300	0.30	-176	7.74	88	0.069	72	0.19	-47
		500	0.34	166	4.70	79	0.113	73	0.16	-40
		700	0.36	158	3.45	70	0.156	70	0.14	-35
		1000	0.36	144	2.46	61	0.217	66	0.11	-39
		1500	0.42	119	1.75	47	0.310	60	0.08	-72

Table 1. Common-Emitter S-Parameters

PACKAGE DIMENSIONS



NOTES:
1. DIMENSION D NOT APPLICABLE IN ZONE N.

DIM	MILLIMETERS		INCHES	
	MIN	MAX	MIN	MAX
A	4.44	5.21	0.175	0.205
C	1.90	2.54	0.075	0.100
D	0.84	0.99	0.033	0.039
F	0.20	0.30	0.008	0.012
G	0.76	1.14	0.030	0.045
K	7.24	8.13	0.285	0.320
L	10.54	11.43	0.415	0.450
N	—	1.65	—	0.065

STYLE 2:
PIN 1. COLLECTOR
2. EMITTER
3. BASE

**CASE 317A-01
ISSUE B**

Motorola reserves the right to make changes without further notice to any products herein. Motorola makes no warranty, representation or guarantee regarding the suitability of its products for any particular purpose, nor does Motorola assume any liability arising out of the application or use of any product or circuit, and specifically disclaims any and all liability, including without limitation consequential or incidental damages. "Typical" parameters can and do vary in different applications. All operating parameters, including "Typicals" must be validated for each customer application by customer's technical experts. Motorola does not convey any license under its patent rights nor the rights of others. Motorola products are not designed, intended, or authorized for use as components in systems intended for surgical implant into the body, or other applications intended to support or sustain life, or for any other application in which the failure of the Motorola product could create a situation where personal injury or death may occur. Should Buyer purchase or use Motorola products for any such unintended or unauthorized application, Buyer shall indemnify and hold Motorola and its officers, employees, subsidiaries, affiliates, and distributors harmless against all claims, costs, damages, and expenses, and reasonable attorney fees arising out of, directly or indirectly, any claim of personal injury or death associated with such unintended or unauthorized use, even if such claim alleges that Motorola was negligent regarding the design or manufacture of the part. Motorola and  are registered trademarks of Motorola, Inc. Motorola, Inc. is an Equal Opportunity/Affirmative Action Employer.

Literature Distribution Centers:

USA: Motorola Literature Distribution; P.O. Box 20912; Phoenix, Arizona 85036.

EUROPE: Motorola Ltd.; European Literature Centre; 88 Tanners Drive, Blakelands, Milton Keynes, MK14 5BP, England.

JAPAN: Nippon Motorola Ltd.; 4-32-1, Nishi-Gotanda, Shinagawa-ku, Tokyo 141, Japan.

ASIA PACIFIC: Motorola Semiconductors H.K. Ltd.; Silicon Harbour Center, No. 2 Dai King Street, Tai Po Industrial Estate, Tai Po, N.T., Hong Kong.



BFR96/D

