

IC-7610 User Evaluation & Test Report

By Adam Farson VA7OJ/AB4OJ

Iss. 8, Nov. 26, 2020.

Figure 1: The Icom IC-7610.



Introduction: This report describes the evaluation of IC-7610 S/N 02001640 in terms of user operation and lab testing. **Appendix 1** presents results of an RF lab test suite performed on the radio. I was able to spend some time with the IC-7610 in my ham-shack, and thus had the opportunity to exercise the radio's principal features and evaluate its on-air behavior.

1: Physical "feel" of the IC-7610. The IC-7610 is similar to its predecessor, the IC-7600, in size and weight. The case dimensions are 340(W) × 118(H) × 277(D) mm and the radio weighs 8.5 kg.

The IC-7610 features a large (7" diagonal) LED-backlit color touch-screen display which dominates the front panel. This is an innovation in Icom's "base" HF transceiver product line, offering easy band/mode selection and navigation through the radio's menus. The placement of many control functions on the touch-screen and in the MULTI knob menus has moved many controls off the front panel.

The IC-7610 represents a major departure from the earlier 756Pro/7600 size/price category in that it has two completely separate and independent receivers, each with its own front end, Digi-Sel® preselector and signal path. The spectrum scope can be split into two independent scopes, MAIN and SUB, which can be displayed side-by-side or MAIN above SUB. Only the REF LEVEL adjustment is shared.

Owners of current Icom IF-DSP transceivers should find the IC-7610 quite familiar, and should feel comfortable with it after a little familiarization with the touch-screen. In addition to the display, the front panel has a number of feature keys in location similar to those on other Icom radios as well as two concentric knobs to the left of the screen (MAIN and SUB AF Gain + RF Gain/Squelch) to the right of the screen (Twin PBT and KEY SPEED/PITCH). On the right side are also the MULTI and RIT knobs. Pressing the MULTI knob opens a context menu on the right edge of the screen; this menu changes with the previously-selected mode or function, allowing adjustment of appropriate parameters.

Either receiver can be muted and un-muted by pressing its AF Gain knob.

The learning curve will be minimal for owners of other Icom IF-DSP radios. The Twin PBT and MULTI controls are multi-turn and detented. The main tuning knob is large and has a knurled Neoprene ring and a rotatable finger-dimple; it turns very smoothly with minimal side-play.

Two front-panel USB "A" ports are provided; these support a keyboard for RTTY and PSK sending, a mouse, the RC-28 Remote Controller and/or a USB thumb-drive. The RC-28 plugs into one of the front-panel USB ports. It serves as a secondary tuning knob which is configurable to tune the MAIN or SUB receiver.

The standard 8-pin MIC socket, and the 6mm PHONES jack, are on the left side of the front panel. The supplied HM-219 hand mic or any other compatible electret or low-impedance dynamic mic can be plugged into the mic jack. (The DC bias on the mic input can be turned off via menu.)

The rear panel features a comprehensive array of ports, including MAIN and SUB external speaker jacks, ACC1 and ACC2 DIN sockets, USB2 and USB3 "B" ports, an Ethernet port, a DVI connector for an external display (selectable 800 × 480 or 800 × 600 resolution) and BNC sockets for RX IN/OUT, EXT REF IN (10 MHz external frequency reference) and a transverter. A large muffin-type cooling fan is also mounted on the rear panel. All BNC ports are configurable via menu.

The SD card slot for memory storage and loading, recording and firmware upgrade is below the AF/RF Gain/Squelch knob. A screen capture function (enabled via menu) allows capture of the current screen image to the SD card as a PNG or BMP file by briefly pressing the POWER key. The image can also be viewed on the screen via menu.

Either the SD card or a USB thumb-drive can be used for saving settings files, audio files, RTTY/PSK31 decodes and screen captures, or for upgrading firmware.

Like its predecessor, the IC-7610 incorporates a fully-functional RTTY/PSK terminal, which displays the decoded text in the lower field of the screen and allows sending from a USB keyboard.

The IC-7610 is solidly constructed and superbly finished. As do other Icom radios, it conveys a tight, smooth, and precise overall feel. The die-cast alloy chassis also serves as a heat dissipator, and the sheet-steel case is finished in an attractive black crinkle coating. The front panel has a smooth, matte surface.

2: IC-7610 architecture. Icom is the first Japanese amateur radio manufacturer to offer HF/6m transceivers embodying direct-sampling/digital up-conversion SDR architecture. **In each receiver**, the RF signal from the antenna(s) feeds an LTC2208 16-bit ADC (analogue/digital converter) via a 2-stage preselector. The first stage is a switchable DigiSel® tracking preselector which protects the ADC from very strong out-of-band signals. The second stage is a set of contiguous half-octave bandpass filters, followed by the ADC driver. The ADC digitizes a portion of the HF range defined by the preselector; the digital output of the converter feeds the Field-Programmable Gate Array (FPGA) which is configured as a digital down-converter (DDC) and delivers a digital 12 kHz "IF" to the DAC (digital/analog converter) which decodes the digital signal back to audio. All signal-processing functions such as selectivity, demodulation etc. are performed in the FPGA, thus eliminating the need for a dedicated DSP.

Figure 2 is a simplified block diagram of the dual receiver subsystem. RF steering relays allow Dual Watch operation in which both receivers are fed from a common antenna via a hybrid splitter, or diversity operation in which each receiver is fed from a separate antenna port. The Tracking feature locks the A and B receiver tuning dials together to facilitate diversity reception.

Figure 2: Simplified block diagram of IC-7610 receivers.

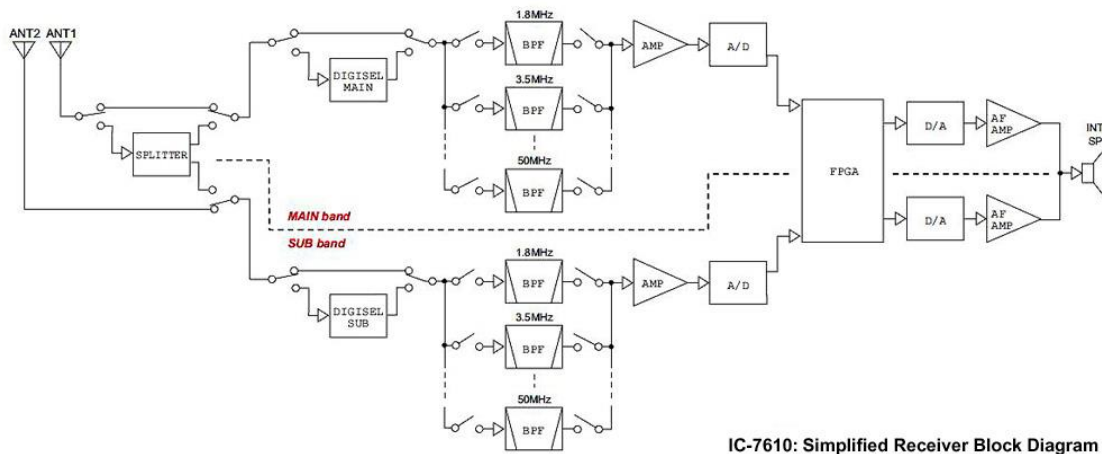

The FPGA also delivers a 1 MHz-wide digital video signal to the Display Processor, which manages the screen displays, including the fast FFT spectrum scope, waterfall, audio scope and audio FFT (spectrum analyzer) as used in other Icom transceivers (7700, 7800, 7850/7851). The spectrum scope has 100 dB dynamic range, a maximum span of ± 500 kHz and adjustable reference level (-10 to +10 dB), along with selectable averaging, video bandwidth (VBW) and resolution bandwidth (RBW), the latter a "first" in an Icom HF transceiver. Minimum RBW ≈ 20 Hz.

The scope can be split into separate MAIN and SUB scopes displayed either left/right or MAIN above SUB.

A unique "touch-tune" feature allows quick tuning to a signal displayed on the scope by touching the scope or waterfall field to magnify an area, then touching the desired signal within that area. In addition, a USB mouse can be plugged in to the front-panel USB "A" port. The mouse allows frequency changing as well as the adjustment of the main scope parameters (sweep speed, RBW, VBW).

In the **transmitter**, the audio codec converts mic audio to a digital baseband, which the DSP then processes further and the digital up-converter in the FPGA then converts to a digital RF signal at the transmit frequency. This signal is converted to analog by the 14-bit DAC (Intersil ISL5961IAZ) to the RF excitation for the PA Unit.

The 100W PA chain (Mitsubishi RD MOSFET family) and T/R switching circuit are similar to the well-proven circuits employed in the IC-7600. The T/R switch consists of a high-current, fast-recovery diode in the TX path, and a miniature SIP relay in the receive path.

The IC-7610 incorporates a relay-chain type auto-tuner with a nominal 3:1 VSWR matching range. The tuner is in the signal path on receive and transmit, and can be bypassed when not required. The tuner also supports an Emergency mode accommodating a gross mismatch (50W output limit).

3: The touch-screen. The large (157 × 87 mm) color TFT **touch-screen** displays a very clear, crisp image, with excellent contrast and color saturation, and an LCD backlight. The home screen (see Figure 1) displays the current frequency in the upper field, the bargraph meter in the middle and the spectrum scope(s) in the lower field. The first key below the screen, MENU, is unique to the Icom SDR line. The MENU key opens the context-sensitive Menu screen. The second key, M.SCOPE, moves the spectrum scope to the middle field; a different screen, selected via the MENU key, can be opened in the lower field (e.g. a multi-function meter, RTTY decoder or CW keyer controls, depending on mode). The waterfall is activated via the EXIT/SET key at the bottom right of the home screen; a reduced-height scope and waterfall can be displayed on the home screen via an EXIT/SET menu parameter.

When the Twin PBT knobs are rotated, the left or right flank of the trapezoidal icon at the top of the screen moves and the shift in Hz (+ or -) is displayed to the left of the icon, as is the actual filter bandwidth. The effect of Twin PBT is also visible on the large passband icon when the FILTER menu is open. Pressing the inner PBT knob clears the Twin PBT setting. Pressing the MULTI knob opens a menu with RF PWR, MIC Gain, COMP and MONITOR settings. A setting is changed by touching its icon and rotating the MULTI knob. The MULTI knob menus are context-sensitive; for example, pressing and holding the NB key activates NB, and displays NB settings when the MULTI knob is pressed. RIT and ΔTX are adjusted by pressing their respective keys on the top right of the front panel and rotating the MULTI knob without pressing it. The CLEAR key clears these functions.

Pressing and holding the Notch, NR and NB keys renders their settings accessible from the MULTI knob. These can be used to select notch width, NR level and NB parameters respectively. When MN is selected, a pop-up displays its width.

TPF (Twin Peak Filter) can be activated via the MULTI menu in RTTY mode. The APF key enables the CW APF (Audio Peak Filter). APF offers selectable SHARP and SOFT shape-factors, each with 3 bandwidth settings, and a 0 - 6 dB gain adjustment.

The **menus** are somewhat akin to those in other current Icom DSP radios. I found the set-up process fairly intuitive after consulting the relevant user-manual sections in cases of doubt. Icom continues the use of a “Smart Menu” system which changes available functions in a context-sensitive manner based on the mode currently in use.

Different screens are selected by pressing the MENU key on the bottom left of the screen. Menu selections with default values can be returned to default by pressing and holding their DEF softkey. Many of the screens have a “Back” arrow key to return to the previous screen.

The FUNCTION key opens a screen with switches for functions such as AGC, COMP, IP+, MONitor, VOX, BK-IN etc. Some of these (NB, NR, Preamp/ATT, NOTCH) duplicate front-panel keys. The MENU screen includes a “SET” icon which opens a list of the 7610’s configuration settings arranged in a hierarchy which is easily navigable. The desired line in the on-screen table can be selected via the MULTI knob or up/down arrows.

The QUICK key opens a context-sensitive Quick Menu for rapid configuration or default setting of various menu functions.

Touching the leading (MHz) digits of the frequency display opens a band-selection screen; the desired band is selected by touching its designator. Mode selection is similar; touching the current mode icon opens the mode-selection screen. Tuning steps for kHz and Hz are set by touch, or by touch/hold, on the respective digit groups.

The filter selection and adjustment procedure is similar to that on other Icom DSP radios. Touch the FIL-(n) icon to toggle between FIL-1, FIL-2 and FIL-3. Touch and hold this icon to adjust the filter bandwidth and select CW/SSB Sharp/Soft shape. All IF filters are continuously adjustable. As in other Icom IF-DSP radios, filters with 500 Hz or narrower bandwidth have the BPF shape factor, but a non-BPF filter can be configured via Twin PBT.

The Time-Out Timer feature limits transmissions to a preset duration (3, 5, 10, 20 or 30 minutes, selectable by menu.) RF PWR can be turned down to 0. This feature is useful when receiving via active antennas or mast-mounted preamplifiers without T/R switching, or to avoid damaging test equipment when conducting receiver measurements.

The AUDIO screen displays an audio FFT spectrum analyzer and oscilloscope very similar to those implemented in the IC-7851, IC-7800 (Firmware V3.00 and higher) and IC-7700 (V2.00 and higher). This feature is very helpful in setting up one's transmit audio parameters, and also for visual audio assessment of a received signal.

4:Receiver front end management.: The P.AMP/key toggles between Preamp OFF, 1 and 2, The ATT key enables a 0-45 dB RF step attenuator adjustable in 3 dB steps. The RF Gain/Squelch control functions as an RF Gain control when rotated counter-clockwise from 12 o'clock; an on-screen RFG icon lights when RF Gain is active.

The input level limit for a direct-sampling receiver is the ADC clip level, where the digital output of the ADC is "all ones". When the ADC clips, the receiver can no longer process signals. Thus, the 7610 provides means to prevent this condition from arising. When the ADC starts clipping, a red OVF (overflow) icon lights to the right of the filter selection icon. At this point, rotating the RF Gain control counter-clockwise will extinguish OVF and restore normal operation. RF Gain should be set just at the point where OVF goes dark, otherwise weak-signal reception will be degraded. If required, ATT can be activated as well. When OVF lights, the preamp should be turned OFF. (In general, use of the preamp on 7 MHz and below is not recommended, as the band noise is almost always higher than the receiver's noise floor and the preamp will only boost band noise without improving signal/noise ratio.)

IP+ (MENU key) activates dither and output randomization in the ADC, to improve the linearity and IMD dynamic range of the ADC. When IP+ is active, an IP+ icon lights.

Being a current IC-7300 owner and having owned an IC-7600, I found that the IC-7610's controls and menus fell readily to hand. A user familiar with a radio such as the IC-756Pro3 or IC-7600 should find the IC-7610 very user-friendly and its learning curve manageable. The IC-7610's default settings are very usable, allowing the radio to be placed in service with minimal initial set-up.

A front-panel AUTO TUNE key "tunes in" CW and AM signals rapidly and accurately.

Touching the currently-displayed meter scale toggles between scales. Touching and holding the meter scale opens the multi-function meter, which displays all scales simultaneously.

5: USB interfaces. The IC-7610 rear panel is equipped with two USB "B" ports, USB2 and USB3. The radio can be directly connected via the USB2 port to a laptop or other PC via the supplied USB cable. This is without doubt one of the IC-7610's strongest features. The USB port transports not only CI-V data, *but also TX and RX PCM baseband* between the IC-7610 and the computer. The USB2 port is configurable via menu to output either PCM soundcard audio or a 12 kHz IF to drive DRM decoders.

6: Ethernet port. The IC-7610 rear panel features a 10/100Base-T Ethernet port, which is fully configurable via menu. The Ethernet port is intended for connection to a LAN or router; it currently supports a resident NTP (Network Time Protocol) client and also a resident RS-BA1 server. When using the radio's internal RS-BA1 server, it is no longer necessary to dedicate a co-located PC for use as a server. This greatly simplifies remote RS-BA1 configurations.

7: Filter selections and Twin PBT. As do the other Icom DSP transceivers, the IC-7610 offers fully-configurable RX IF selectivity filters for all modes. Three default filter selections are available via the touch-screen for each mode, with continuously variable bandwidth via the FILTER menu. In addition, there are selectable Sharp and Soft shape factors for SSB and CW. The BPF filter configuration feature (for filter bandwidths of 500 Hz or less) operates in the same manner as on other Icom IF-DSP radios.

8: BPF vs. non-BPF filters. As in other Icom IF-DSP radios, the IC-7610 allows the user to select two additional shapes for 500 Hz or narrower filters, in addition to SHARP and SOFT. These are BPF (steeper skirts) and non-BPF (softer skirts).

To configure a BPF filter, select a 500 Hz or narrower CW, RTTY or SSB-D filter with Twin PBT neutral. To set up a non-BPF filter, select a filter with BW > 500 Hz, and narrow the filter to 500 Hz or less by rotating the Twin PBT controls. When Twin PBT is displaced from its neutral position, a dot appears to the right of the filter icon at the top of the screen.

9: Notch filters. The tunable manual notch filter (MN) is inside the AGC loop, and is extremely effective. The MN has 3 width settings (WIDE, MID and NAR); its stopband attenuation is at least 70 dB. The manual notch suppresses an interfering carrier before it can stimulate AGC action; it thus prevents swamping. To adjust the notch frequency precisely, press and hold the NOTCH key, then rotate the main tuning knob.

The auto notch filter (AN) is post-AGC. It suppresses single and multiple tones, but strong undesired signals can still cause AGC action and swamp the receiver. MN and AN are mutually exclusive, and AN is inoperative in CW mode. The NOTCH key toggles OFF – AN – MN. When MN is selected, a pop-up field is displayed on the screen, allowing selection of WIDE, MID or NAR (narrow) notch by pressing and holding the NOTCH key.

10: NR (noise reduction). The DSP NR is very effective. In SSB mode, the maximum noise reduction occurs at an NR control setting of 10. As NR level is increased, there is a slight loss of “highs” in the received audio; this is as expected. The measured SINAD increase in SSB mode was about 13 dB. For precise NR adjustment, press and hold the NR key, then rotate the MULTI knob.

11: NB (noise blanker). The IF-level DSP-based noise blanker is arguably one of the IC-7610’s strongest features. I have found it to be extremely effective in suppressing fast-rising impulsive RF events before they can stimulate AGC action within the DSP algorithm. The NB completely blanks noise impulses which would otherwise cause AGC clamping. I found its performance comparable to that of the IC-7700’s NB. The NB menu (threshold, depth and width) is accessed by pressing and holding the NB key. The NB works very effectively in conjunction with NR.

12: AGC system. The IC-7610 has an in-channel AGC loop. The digital AGC detector for the AGC loop is within the DSP algorithm. Level indications from the detector are processed in the DSP, and control the DC bias on a PIN-diode attenuator at the RF ADC input. This architecture prevents strong adjacent signals from swamping the AGC, and allows full exploitation of the ADC’s dynamic range.

The AGC menu is similar to that of other Icom IF-DSP radios. The Slow, Mid and Fast AGC settings are customizable via menu for each mode, and AGC can be turned OFF via menu. Operation with AGC off is not generally recommended on a direct-sampling SDR, as this can lead to early ADC clipping.

13: Receive and transmit audio menus. The IC-7610 TONE SET menu offers the same generous selection of audio configuration parameters as that of the IC-7600 and IC-7700: TBW (low and high cutoff frequencies), RX and TX Bass/Treble EQ, RX HPF and LPF, transmit compression, etc. All audio settings are grouped under the SET/Tone Control menu.

14: Metering. The on-screen bar-graph meter displays the S-meter at all times; touching the scale toggles between P_o, SWR, ALC and COMP. Touch and hold displays the multi-function meter.

15: RTTY decoder and memory keyer. The IC-7610 features an on-screen RTTY/PSK decoder/display as well as an 8 x 70 chars RTTY memory keyer for transmitting short messages.

16: VFO/Memory management. Both IC-7610 receivers offer the same VFO and memory management features as other current Icom HF+ transceivers: VFO/memory toggle and transfer, memory write/clear, memo-pad, Split, VFO A/B swap [A/B] and equalize [touch and hold A/B], etc.

In addition, the MAIN and SUB receivers can be exchanged via the CHANGE key, or synchronized for diversity reception by enabling Tracking.

17: Brief “on-air” report. Upon completing the test suite, I installed the IC-7610 in my shack and connected it to my 1 kW amplifier and multi-band HF/6m vertical antenna.

a) SSB. I spent several hours chatting on 40m SSB with friends who are familiar with my voice and the sound of my signal. Distant stations reported that the audio quality of my transmissions was "excellent" when using the supplied HM-219 hand mic.

The following are the transmit audio settings I used in the SSB trials:

Table 1: Transmit audio settings.

Mic	Band	Conditions	Mic Gain	TBW	COMP	Bass	Treble
HM-219	40m	S9+	50%	WIDE 200-2900	5	0	+3
NATO	40m	S9+	20%	WIDE 100-2900	5	+1	+1

As discussed in **11.** above, the DSP-based noise blanker is superb. It does not distort the signal at all, and can be left on at all times; it is every bit as good as the IC-7700 or IC-7600 blanker. At my QTH, with Level 5, Width 80 and Depth 8, the NB suppressed fast-rising noise spikes and almost completely eliminated locally-generated electrical noise from HV power lines, industrial processes and switch-mode street-lighting ballasts.

As discussed in **10.** above, I found the NR very effective on SSB. Even at settings of 9 to 10, NR did not attenuate "highs" excessively. NR is very effective in conjunction with NB.

Preamp 1 (7 dB gain) brought weak stations up to very comfortable copy without S/N degradation. The SSB filters and Twin PBT were excellent, as we have come to expect from other Icom DSP radios. MN and AN were extremely helpful. I was able to notch out single tones with MN; also, AN reduced the levels of multiple tones. I did not use Preamp 2 on 40m, as it is optimized for 50 MHz and higher.

The superior phase-noise performance of a direct-sampling SDR (as compared to a conventional superhet) and the absence of the passive IMD attributable to crystal filters in the signal path really showed in the 7610's clean reception in the presence of strong adjacent-channel interference during my on-air SSB tests.

Overall, I found that band noise on SSB at my QTH was sufficiently obtrusive to require the use of NR (Level 9 to 10) at all times. Still, SSB operation on 20m with a mix of strong and weak signals was quite comfortable and pleasant. Receive audio quality was crisp and smooth. Subjectively, I was impressed by the clarity of received signals.

b) CW: I made a brief CW QSO on 40m using a straight key. With 500 and 250 Hz CW filters (Sharp, BPF) and NR/NB on, ringing was minimal with Preamp off. I then set up a 250 Hz filter (Soft, non-BPF) with NR on and Preamp off. Again, there was virtually no audible ringing, and the received CW note was very smooth. Activating Preamp 1 or 2 raised the noise level slightly, but did not cause significant ringing.

In a brief test of full-break-in operation at 24 wpm, I found this mode quite smooth, with fast receiver recovery. Keying transitions were smooth, without "thumping" sounds.

c) AM: In a quick check of AM reception, I listened to various MF and HF broadcast stations. A local station on 690 kHz and a music broadcast on 5995 kHz sounded good on the IC-7610's internal speaker, but much clearer (as one would expect) on my headset or external speaker. I noted that the AM IF filters cut off quite steeply below 200 Hz.

The 9 kHz AM filter offered the best frequency response, but the 6 kHz setting sounded somewhat “smoother” and 3 kHz cut the “highs” excessively. The IC-7610’s Twin PBT is fully functional in this mode. Mid AGC was best for average to good signal conditions, but Fast AGC handled rapid selective fading more effectively. NR was quite effective in improving the S/N ratio of weak AM signals.

The NR did not distort the recovered audio. NR Level 9-10 was the “sweet spot”, providing optimum noise reduction. Above 10, the NR control had no further effect. (Note that the AM bass and treble EQ settings were both 0 dB, with HPF off.)

AN was effective in suppressing interfering tones and heterodynes, but MN caused some distortion when tuned across an AM signal. The reason for this is that MN suppresses the carrier in a manner similar to selective fading.

The AUTO TUNE feature pulled in CW and AM signals very accurately and quite rapidly.

Slight hiss was evident when receiving weak AM signals, but NR largely suppressed it.

d) RTTY/PSK: I tuned in some 40m RTTY signals and was able to tune them accurately with the FFT tuning aid and decode them reliably using the internal decoder.

18. ACC/USB AF Output Level Check: During receiver testing, I checked the receive AF levels at the USB port using a spectrum-analysis program, and at ACC1 Pin 5 using a true RMS voltmeter. All levels were well within specifications.

18a. ACC MOD and USB MOD Input Level Check: During transmitter testing, I also checked the AF input levels at the USB port using a tone-generator program, and at ACC Pin 11 using an audio signal generator, for 100W PEP output. All levels were well within specifications. To use the USB port, I installed the Ver. 1.2 Icom USB drivers (downloadable from the Icom Japan world-wide support site).

<http://www.icom.co.jp/world/support/download/firm/>

19. Case temperature: The radio showed no signs of excessive heating even after 2 hours’ “rag-chew” SSB operation at 100W PEP output. Average case temperature was 30°C, rising to 32°C at the hottest point after several minutes’ key-down transmit at 100W during transmitter testing (temperature indicator blue).

20. Concerns: Two items warranting further analysis were encountered during the tests: the trapezoidal shape of the transmitted CW envelope at 48 wpm and transmitted IMD3 performance on 50 MHz. These will be discussed in more detail in the relevant sections of this report.

21. Conclusion: After a few days’ “cockpit time” on the IC-7610, I am very favorably impressed by its solid, refined construction, clear and informative display, easy familiarization experience, smooth operating “feel”, impressive array of features and excellent on-air performance. This radio is unique in that it is a true, stand-alone* direct-sampling/digital up-conversion SDR offering two fully-functional, independent receivers and a rich array of features in an attractive, compact package.

Yet again, Icom has a winner with the SDR performance, intuitive touch-screen and the straightforward USB computer interface. Although the IC-7610 is in a higher price category than the IC-7300, I nonetheless feel that the 7610 provides excellent value and capability for its price..

22. Acknowledgements: I would like to thank Ray Novak N9JA at Icom America, and Paul Veel VE7PVL and Jim Backeland VE7JMB at Icom Canada for making an IC-7610 available to me for testing and evaluation.

**Stand-alone SDR: self-contained, not requiring a computer as a prerequisite for operation.*

Adam Farson, VA7OJ/AB4OJ Feb. 20, 2018.

e-mail: farson@shaw.ca <http://www.ab4oj.com/>.

Update history:

Iss.1: Jan. 22, 2018. Pre-release.

Iss. 1a, Feb. 5, 2018. Released version, dates corrected.

Iss. 2, Feb. 20, 2018. 11700 kHz NPR retest with correct BLF.

Iss. 3. Apr. 13, 2018. 16400 kHz NPR, APF shape, RTTY (FSK/F1B) tests added and aliasing rejection re-tested.

Iss. 4: Jul. 5, 2018. Transverter port power output and phase noise tests added.

Iss. 5: Aug. 5, 2018. Firmware V1.11 SSB-D TBW overshoot test added.

Iss. 6: Oct. 30, 2018. Inter-receiver crosstalk data updated.

Iss. 7: Sep. 14, 2019. XVTR phase noise renamed 'composite noise'.

Iss. 8: Nov. 26, 2020. Added phase noise plots taken on R&S FSUP 8 analyzer.

Copyright © 2018-2019 A. Farson VA7OJ/AB4OJ. All rights reserved.

Appendix 1: Performance Tests on IC-7610 S/N 02001640

As performed in my home RF lab, Jan. 22 - Feb. 3, 2018, Feb. 20, 2018 and Nov. 26, 2020.

⚠ 10 MHz external reference at -10 dBm for all tests. Firmware at V1.04 for RX tests.

A. HF/6m Receiver Tests (MAIN Rx).

1: MDS (Minimum Discernible Signal) is a measure of ultimate receiver sensitivity. In this test, MDS is defined as the RF input power which yields a 3 dB increase in the receiver noise floor, as measured at the audio output.

Test Conditions: SSB 2.4 kHz & CW 500 Hz SHARP, ATT off, NR off, NB off, Notch off. AGC-M. Max. RF Gain, Levels in dBm. IP+ off except where shown.

Table 2a: MAIN Rx MDS (HF, 6m).

MHz	1.9		3.6		14.1		28.1		50.1	
	SSB	CW	SSB	CW	SSB	CW	SSB	CW	SSB	CW
Preamp Off	-126	-132	-126	-134	-126	-133	-125	-133	-122	-129
Off/IP+	-122	-129	-123	-131	-123	-129	-122	-129	-121	-127
1	-133	-138	-135	-142	-134	-140	-133	-139	-131	-139
2	-135	-142	-137	-142	-136	-142	-136	-142	-134	-140

Table 2b: SUB Rx MDS (HF, 6m)

MHz	3.6		14.1		50.1	
	SSB	CW	SSB	CW	SSB	CW
Preamp Off	-126	-133	-125	-132	-121	-128
Off/IP+	-123	-129	-123	-129	-121	-127
1	-132	-140	-130	-139	-131	-136
2	-133	-141	-132	-140	-132	-139

Note on IP+ and MDS: With IP+ on and Preamp off, 3 - 4 dB MDS degradation was observed. In addition, the AF background noise level rises by approx. 3 dB with Preamp off, 2 dB with Preamp 1 on and 0.5 dB with Preamp 2 on.

This is a significant improvement over the IC-7300, and is attributable to the 16-bit ADC's and superior ADC clock source in the IC-7610. (IP+ activates ADC dither and randomization.)

1a: ADC Clip Levels. In this test, the receiver is offset +25 kHz above the test signal frequency and the input level required to light the on-screen **OVF** icon is noted.

OVF indication occurs only when a strong out-of-channel signal is present. In-channel signals stimulate AGC action which attenuates the signal at the ADC input.

Test Conditions: RX tuned to 14.1 MHz, test signal freq. 14.125 MHz, CW 500 Hz SHARP, ATT off, NR off, NB off, Notch off. AGC-M. Max. RF Gain.

Table 3: OVF (Clip) Levels.

Preamp	OVF (Clip) Level dBm
Off	-9
IP+	-9
1	-20
2	-28

1b: Digi-Sel Insertion Loss: The difference between MDS with the Digi-Sel preselector IN and OUT is measured and recorded for several HF bands.

Test Conditions: CW 500 Hz SHARP, ATT off, NR off, NB off, Notch off. IP+ off. AGC-M. Max. RF Gain. A negative loss value denotes gain.

Table 4: Digi-Sel Insertion Loss

MHz	1.9	3.6	7.1	14.1	21.1	28.1
Digi-Sel Loss	-1	3	0	2	4	6

Ic: Dual Watch Splitter Insertion Loss: The difference between MDS in single-RX and Dual Watch modes is measured and recorded.

Test Conditions: 14.1 MHz, CW 500 Hz SHARP, ATT off, NR off, NB off, Notch off. IP+ off. AGC-M. Max. RF Gain.

Test Results: Splitter insertion loss to MAIN RX: 3 dB. Splitter insertion loss to SUB RX: 2 dB.

Id: AM Sensitivity. Here, an AM test signal with 30% modulation at 1 kHz is applied to the RF input. The RF input power which yields 10 dB (S+N)/N is recorded (Table 4).

Test Conditions: ATT off, NR off, NB off, Notch off. AGC-M. 6 kHz AM filter. Levels in dBm.

Table 5: AM Sensitivity.

Preamp	0.9 MHz	3.9 MHz	14.1 MHz
Off	-107	-108	-108
1	-115	-117	-116
2	-118	-120	-118

Notes:

1. Very clean demodulation; full quieting \approx -76 dBm (preamp off).
2. NR suppresses high-frequency hiss at low signal levels. Unmodulated carrier at -117dBm (preamp off, NR off) increases noise floor by 4 dB.

Ic: 12 dB SINAD FM sensitivity. In this test, a distortion meter is connected to LINE OUT, and an FM signal modulated by a 1 kHz tone with 3 kHz peak deviation is applied to the RF input. Input signal power for 12 dB SINAD is recorded (Table 4). MF Filter: 15 kHz.

Table 5: FM 12 dB SINAD Sensitivity in dBm.

Preamp	29.5 MHz	52.525 MHz
Off	-112	-109
1	-119	-117
2	-122	-120

Id: Inter-receiver crosstalk: In this test, MAIN and SUB are set to the same frequency, mode and bandwidth. A test signal of amplitude P_i is applied to the MAIN input, and the SUB input is terminated in 50Ω . The value of P_i required to increase the SUB audio output by 3 dB is recorded. The test is then repeated with the MAIN input terminated in 50Ω and the test signal applied to the SUB input. The receiver to which the test signal applied is muted.

Test Conditions: MAIN and SUB set to 500 Hz CW and tuned to f_0 . ATT = 0 dB, NR off, NB off, Preamps OFF, AGC: MAIN: Slow, SUB: Slow.

Crosstalk rejection in dB = P_i – output RX MDS.

Table 10: MAIN/SUB Crosstalk.

f_0 MHz	Test signal to	P_i dBm for +3 dBr output	Rej. dB	Output from
50.1	MAIN	-87	41	SUB
	SUB	-78	51	MAIN
7.1	MAIN	-107	27	SUB
	SUB	-107	26	MAIN
1.9	MAIN	-80	53	SUB
	SUB	-80	53	MAIN

2: Reciprocal Mixing Noise occurs in a direct-sampling SDR receiver when the phase-noise sidebands of the ADC clock mix with strong signals close in frequency to the wanted signal, producing unwanted noise products in the detection channel and degrading the receiver sensitivity. Reciprocal mixing noise is a measure of the ADC clock’s spectral purity.

In this test, a test signal from a high-quality 5 MHz OCXO with known low phase noise is injected into the receiver's RF input at a fixed offset from the operating frequency. The RF input power is increased until the receiver noise floor increases by 3 dB, as measured at the audio output. Reciprocal mixing noise, expressed as a figure of merit, is the difference between this RF input power and measured MDS. The test is run with preamp off. The higher the value, the better.

Test Conditions: 5.000 MHz, CW mode, 500 Hz filter, SHARP, preamp off, ATT off, NR off, IP+ off, AGC-M, NB off, max. RF Gain, positive offset. Reciprocal mixing in dB = input power – MDS (both in dBm). Phase noise in dBc/Hz = $-(\text{RMDR} + 10 \log 500) = -(\text{RMDR} + 27)$.

For $\Delta f \geq 20$ kHz, OVF indicator lights before noise floor increases by 3 dB.

Table 6a: MAIN RX RMDR in dB (HF).

Δf kHz	MDS dBm	RMDR dB	Phase noise dBc/Hz
1	-134	113	-140
2		114	-141
5		116	-143
10		121	-148
15		122	-149
20		> 122	CLIP

Table 6b: SUB RX RMDR in dB (HF).

Δf kHz	MDS dBm	RMDR dB	Phase noise dBc/Hz
1	-135	113	-140
2		115	-142
5		116	-143
10		120	-147
15		123	-150
20		> 123	CLIP

Note: The RMDR readings are unaffected when switching between internal and external frequency reference.

3: IF filter shape factor (-6/-60 dB). This is the ratio of the -60 dB bandwidth to the -6 dB bandwidth, which is a figure of merit for the filter's adjacent-channel's rejection. The lower the shape factor, the "tighter" the filter.

In this test, an approximate method is used. An RF test signal is applied at a power level approx. 60 dB above the level where the S-meter just drops from S1 to S0. The bandwidths at -6 and -60 dB relative to the input power are determined by tuning the signal generator across the passband and observing the S-meter.

Test Conditions: 14.100 MHz, SSB/CW modes, preamp off, IP+ off, AGC-M, ATT off, NR off, NB off.

Table 7: IF Filter Shape Factors.

Filter	Shape Factor		6 dB BW kHz	
	Sharp	Soft	Sharp	Soft
2.4 kHz SSB	1.37	1.30	2.53	2.68
1.8 kHz SSB	1.79	1.50	1.95	2.32
500 Hz CW	1.68	1.65	0.52	0.55
250 Hz CW	2.39	2.64	0.26	0.24

3a: CW APF Filter Bandwidth & Gain. An RF test signal is applied at S9 (-73 dBm), and the Audio Peak Filter (APF) is turned on and centered on this signal. The AF output level is observed on an RMS voltmeter connected to LINE OUT. The filter gain (AF level in the MULTI sidebar) is set at 0, 3 and 6 dB in turn and the measured level change noted.

Next, the receiver is de-tuned either side of the test signal until the AF level falls by 3 dB, and the total frequency difference is noted. This is the filter's 6 dB bandwidth. The test is repeated for SHARP and SOFT Types (shape factors), and for all 3 bandwidth settings.

Test Conditions: 1.900 kHz, 500 Hz CW (Sharp), Preamp off, IP+ off, AGC M, ATT off, NR off, NB off., CW Pitch 600 Hz (default), BK-IN off, APF on, Sharp, Width 160 Hz, AF Level 0 dB.. Initial RF input level -73 dBm. See Tables 8a, 8b.

Table 8a: CW APF Gain

APF AF Level Setting dB	Gain dB
0	0
3	3
6	6

Table 8b: CW APF Bandwidth

TYPE	WIDTH	-3 dB BW
SHARP	320 Hz	325
	160 Hz	162
	80 Hz	41
SOFT	WIDE	153
	MID	104
	NAR	82

3b. CW APF Shape: Noise loading is applied at \approx S6, and the APF is enabled. The APF passband response is displayed on the Audio FFT Scope, as shown in Figure 3.

Test Conditions: 14.1 MHz CW, FIL1, 600 Hz BW, -350 Hz SFT. Preamp OFF, ATT OFF, NR/NB OFF, AGC Slow. APF: 320 Hz (SHARP), WIDE (SOFT), AF LEVEL 6 dB (max).

Figure 3: CW APF passband response.

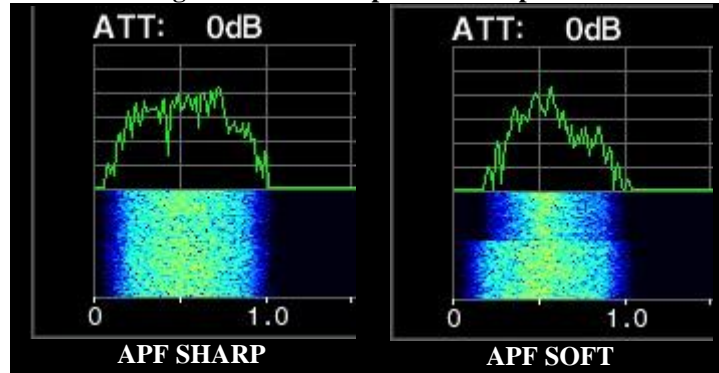

Note that the APF passband is much more “rounded” in SOFT than in SHARP. Also, the sound quality is audibly “softer” and may be less fatiguing in long-term listening.

4: AGC threshold. An RF test signal is applied at a level 6 dB below AGC threshold, initially with AGC off. The signal is offset 1 kHz from the receive frequency to produce a test tone. The AF output level is observed on an RMS voltmeter connected to LINE OUT.

Next, with AGC-M, increase RF input power until AF output level increases < 1 dB for a 1 dB increase in input level. Measured values per Table 9.

Table 9: AGC Threshold.

Preamp	AGC Threshold dBm
Off	-96
1	-101
2	-102
IP+	-96

5: Manual Notch Filter (MNF) stopband attenuation and bandwidth. In this test, an RF signal is applied at a level ≈ 70 dB above MDS. The test signal is offset 1 kHz from the receive frequency to produce a test tone. The MNF is carefully tuned to null out the tone completely at the receiver audio output. The test signal level is adjusted to raise the baseband level 3 dB above noise floor. The stopband attenuation is equal to the difference between test signal power and MDS.

Test Conditions: 14.100 MHz USB at ≈ -63 dBm (S9 + 10 dB), 2.4 kHz Sharp, AGC-M, preamp off, IP+ off, ATT off, NR off, NB off, MNF on, Twin PBT neutral.

Test Results: Measured MDS was -133 dBm per Test 1. Stopband attenuation = test signal power - MDS.

Table 10a: Manual Notch Filter Attenuation.

MNF BW	Test Signal dBm	Stopband Atten. dB
WIDE	-31	82
MID	-55	78
NAR	-57	69

5a: MNF Bandwidth. The receive frequency is now offset on either side of the null by pressing and rotating the MULTI knob. The frequencies at which the audio output rises by 6 dB are noted. The **-6 dB bandwidth** is the difference between these two frequencies.

Table 10b: MNF BW.

MNF -6 dB BW Hz	
Wide	148
Mid	102
NAR	63

5b: Auto-Notch (AN) Check. AN completely suppresses AF tone at -7 dBm input level.

6: AGC impulse response. The purpose of this test is to determine the IC-7610's AGC response in the presence of fast-rising impulsive RF events. Pulse trains with short rise times are applied to the receiver input.

Test Conditions: 3.6 MHz LSB, 2.4 kHz SSB filter (Sharp), NR off, NB off/on, Preamp off/1/2, AGC-F, with decay time set to 0.1 sec.

Figure 4a: Audio scope display for AGC impulse response test (NR/NB off).

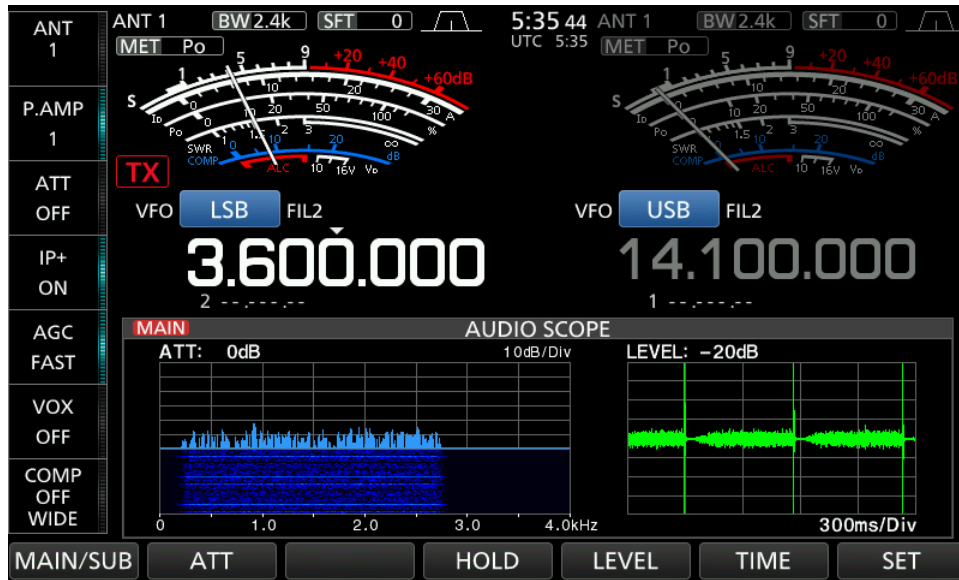

Test with pulse trains. Here, the pulse generator is connected to the IC-7610 RF input via a step attenuator. The IC-7610 is tuned to 3.6 MHz, as the RF spectral distribution of the test pulse train has a strong peak in that band. AGC Fast (0.1 sec) and Preamp 2 are selected.

The pulse rise time (to 70% of peak amplitude) is 10 ns. Pulse duration is varied from 12.5 to 100 ns. In all cases, pulse period is 600 ms. The step attenuator is set at 23 dB. Pulse amplitude is $16V_{pk}$ (e.m.f.)

The AGC recovers completely within the 0.1 sec window; there is no evidence of clamping. NR softens the tick sound.

Table 11: AGC impulse response.

Pulse duration ns	Tick	AGC recovery ms	S: Pre off	S: Pre 1
12.5	Y	≈ 100 (no clamping)	S5	S5
30	Y	≈ 100 (no clamping)	S5	S5
50	Y	≈ 100 (no clamping)	S5	S5
100	Y	≈ 100 (no clamping)	S5	S9

7: Noise blanker (NB) impulse response. As the IC-7610's noise blanker is a DSP process "upstream" of the AGC derivation point, the NB should be very effective in suppressing impulsive RF events before they can stimulate the AGC. To verify this, the NB is turned on during Test 6 (above).

Test Conditions: NB on, Preamp 1 or 2, Level 50%, Depth 8, Width 80.

At all pulse durations, the S-meter deflection and "ticks" are *completely suppressed* (with Preamp off, 1 and 2) showing that the impulsive events never reach the AGC derivation point.

Next, NR is activated. With NR at 8, background noise is suppressed.

- As in other Icom IF-DSP radios, the NB mitigates AGC response to fast-rising RF events.

Figure 4b: Audio scope display for AGC impulse response test (NB on).

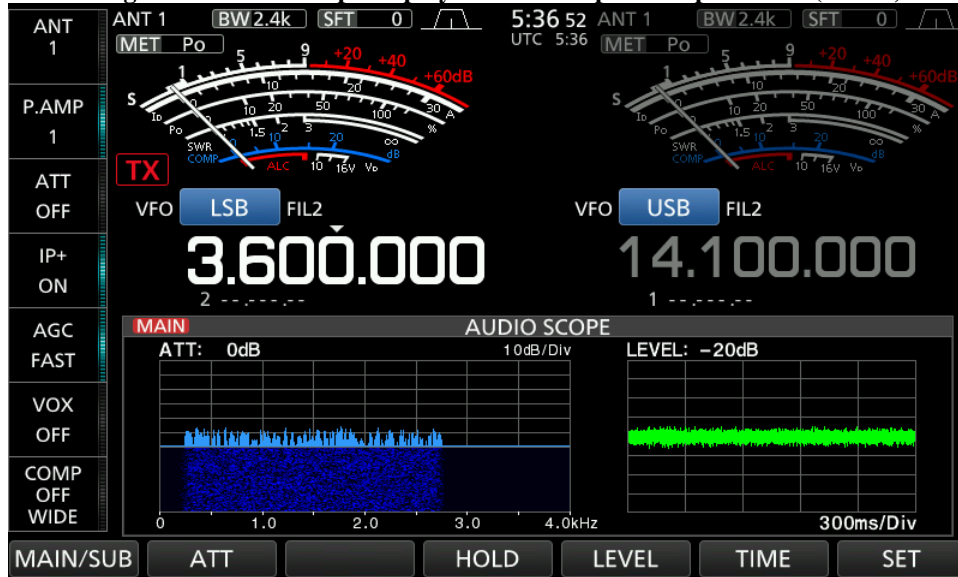
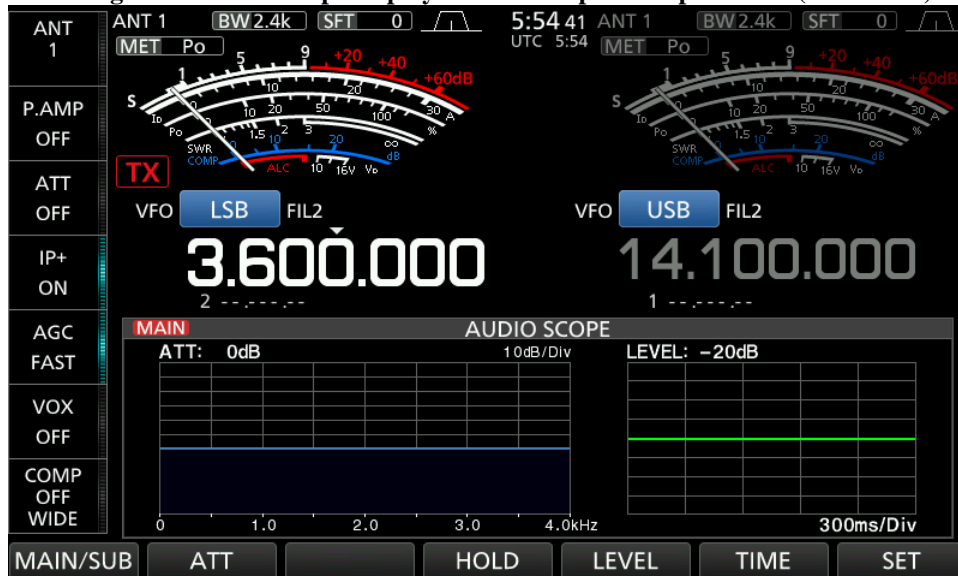

Figure 4c: Audio scope display for AGC impulse response test (NB/NR on).



8: S-meter tracking & AGC threshold. This is a quick check of S-meter level tracking.

Test Conditions: 2.4 kHz USB, Preamp off, ATT off, AGC MID. A 14.100 MHz test signal at MDS is applied to the RF input. The signal power is increased, and the level corresponding to each S-meter reading is noted. (S9 readings are taken with Preamp off, Preamp 1 and Preamp 2 in turn.)

Table 12a: S-Meter Tracking (levels in dBm).

S	S1	S2	S3	S4	S5	S6	S7	S8	S9	S9+10	S9+20	S9+30	S9+40	S9+50	S9+60
MAIN	-93	-91	-88	-86	-83	-80	-78	-75	-72	-60	-52	-43	-33	-23	-11
SUB	-93	-91	-89	-86	-84	-81	-78	-75	-72	-62	-53	-43	-33	-24	-13
MAIN: S9 = -79dBm (Preamp 1), -78 dBm (Preamp 2). SUB: S9 = -78dBm (Preamp 1), -79 dBm (Preamp 2)															

Table 12b: MAIN Attenuation in dB

ATT Value dB	0	6	12	18	24	30	36	42	45
Atten. dB	0	6	12	18	24	30	37	43	47

9: Two-Tone 3rd-Order Dynamic Range (DR₃). The purpose of this test is to determine the range of signals which the receiver can tolerate while essentially generating no spurious responses.

In this test, two signals of equal amplitude P_i and separated by a 2 kHz offset Δf are injected into the receiver input. If the test signal frequencies are f_1 and f_2 , the offset $\Delta f = f_2 - f_1$ and the 3rd-order intermodulation products appear at $(2f_2 - f_1)$ and $(2f_1 - f_2)$.

A pair of low-noise crystal oscillators is used as a signal source to minimize source phase-noise effects.

The two test signals are combined in a passive hybrid combiner and applied to the receiver input via a step attenuator. The receiver is tuned to the upper and lower 3rd-order IMD products $(2f_2 - f_1)$ and $(2f_1 - f_2)$ respectively which appear as a 600 Hz tone in the speaker. The per-signal input power level P_i is adjusted to raise the noise floor by 3 dB, i.e. IMD products at MDS. The P_i values for the upper and lower products are recorded and averaged. $DR_3 = P_i - MDS$.

The audio noise output is measured with an RMS AC voltmeter connected to LINE OUT.

DR₃ is measured with IP+ off and on, to determine the effect of internal dither and randomization on front-end linearity.

Note: IP_3 (3rd-order intercept) is not included here, as this parameter is irrelevant to a direct-sampling SDR. The transfer and IMD curves of the ADC diverge, so the intercept point does not exist.

Test Conditions: $f_1 = 11990.4$ kHz, $f_2 = 11992.4$ kHz, 500 Hz CW, AGC-S, ATT off, Preamp off, NR off, NB off, CW Pitch = 12 o'clock.

Table 13: 20m DR₃.

MAIN		SUB	
IP+ off	IP+ on	IP+ off	IP+ on
92	99	87	100

9a: Two-Tone 2nd-Order Dynamic Range (DR₂) & Second-Order Intercept (IP₂). The purpose of this test is to determine the range of signals far removed from an amateur band which the receiver can tolerate while essentially generating no spurious responses within the amateur band.

In this test, two widely-separated signals of equal amplitude P_i are injected into the receiver input. If the signal frequencies are f₁ and f₂, the 2nd-order intermodulation product appears at (f₁ + f₂). The test signals are chosen such that (f₁ + f₂) falls within an amateur band.

The two test signals are combined in a passive hybrid combiner and applied to the receiver input via a step attenuator. The receiver is tuned to the IMD product (f₁ + f₂) which appears as a 600 Hz tone in the speaker. The per-signal input power level P_i is adjusted to raise the noise floor by 3 dB, i.e. IMD product at MDS. The P_i value is then recorded.

$$DR_2 = P_i - MDS.$$

Test Conditions: f₁ = 6.1 MHz, f₂ = 8.1 MHz, CW mode, 500 Hz filter, AGC off, ATT off, NR off, NB off, CW Pitch = 12 o'clock. DR₂ in dB

Table 14: 6.1/8.1 MHz DR₂.

M/S	Digi-Sel	IP+	MDS dBm, 14.2 MHz	DR ₂ dB
MAIN	off	off	-133	110
		on	-129	109
	on	off	-131	111
		on	-127	108
SUB	off	off	-132	109
		on	-129	110
	on	off	-130	111
		on	-127	109

9b: Two-Tone IMD₃ (IFSS, Interference-Free Signal Strength) tested in CW mode (500 Hz), ATT = 0 dB, AGC Med. Test frequencies: f₁ = 14010 kHz, f₂ = 14012 kHz. IMD₃ products: 14008/14014 kHz. IMD₃ product level was measured as absolute power in a 500 Hz detection bandwidth at various test-signal power levels with IP+ (Dither/Random) off, on and on with Preamp 1. AGC off, ATT= 0 dB. The ITU-R P-372.1 band noise levels for typical urban and rural environments are shown as datum lines. The input level at the top end of each curve corresponds to -1 dBFS, or 1 dB below OVF (ADC clip) level. See Figures 5a (MAIN RX) and 5b (SUB RX).

The IMD product level was derived by measuring the S/N ratio of the IMD product for each input level setting, and subtracting MDS.

$$\text{IMD product amplitude} = - (\text{MDS} - \text{S/N}) \text{ dBm}$$

where MDS is in dBm and S/N in dB.

Test Conditions: f₁ = 14010 kHz, f₂ = 14012 kHz, 500 Hz CW, AGC off, ATT off, Preamp off, NR off, NB off, CW Pitch = 12 o'clock.

Figure 5a: MAIN Receiver IFSS (2-tone IMD₃) vs. test signal level.

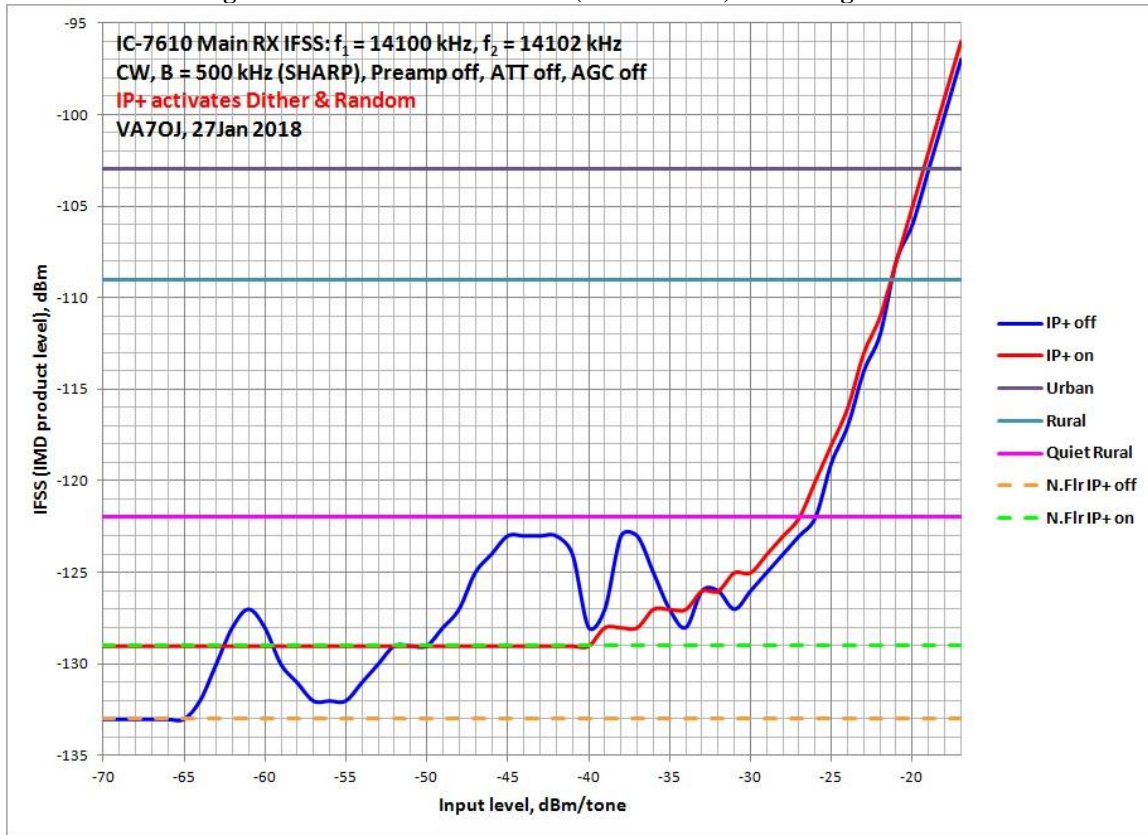
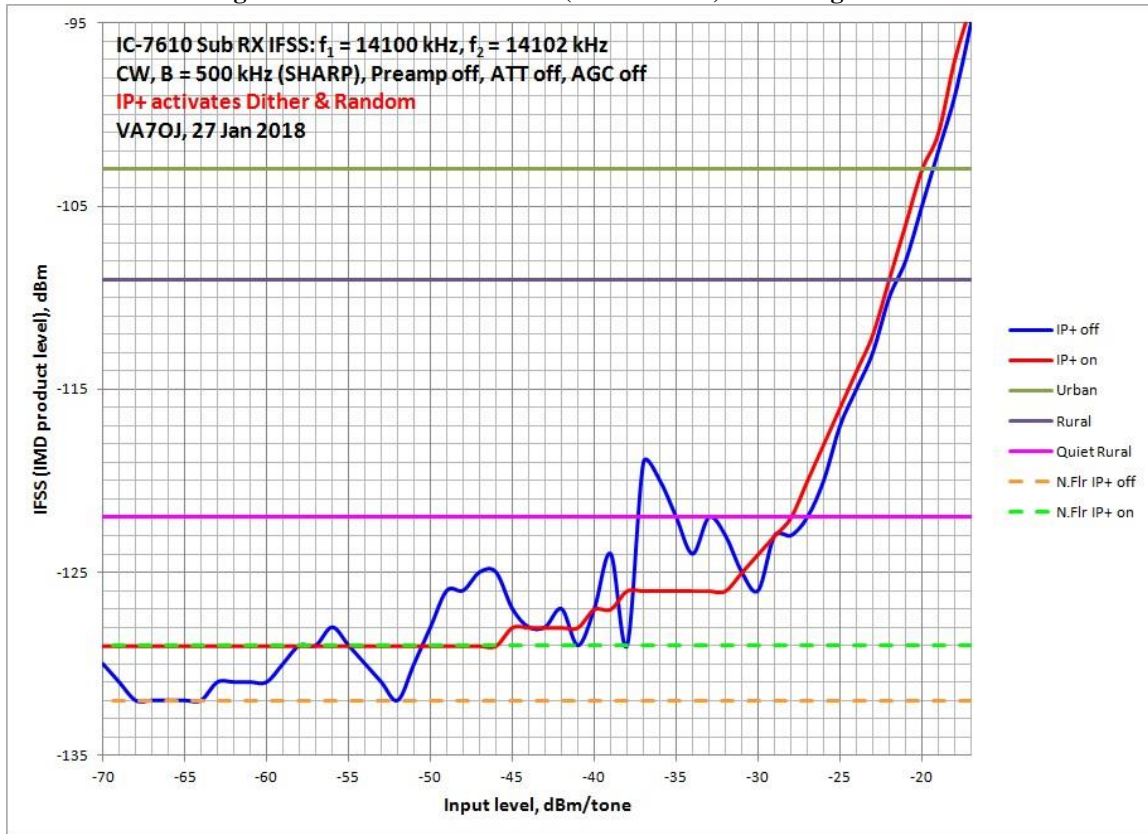

Figure 5b: SUB Receiver IFSS (2-tone IMD₃) vs. test signal level.



Notes on 2-tone IMD₃ test: IFSS (Interference-Free Signal Strength) is a new data presentation format in which the amplitude relationship of the actual IMD₃ products to typical band-noise levels is shown, rather than the more traditional DR₃ (3rd-order IMD dynamic range) or SFDR (spurious-free dynamic range). The reason for this is that for an ADC, SFDR referred to input power rises with increasing input level, reaching a well-defined peak (“sweet spot”) and then falling off. In a conventional receiver, SFDR falls with increasing input power.

If the IMD₃ products fall below the band-noise level at the operating site, they will generally not interfere with desired signals.

The IC-7610 IFSS data is presented here as an adjunct to the traditional DR₃ test data. See *Reference 1*.

10: Spectrum Scope Resolution Bandwidth. In a spectrum analyzer, the resolution bandwidth (RBW) determines how far apart in frequency two (or more) signals must be to be resolved into separate and distinct displays on the screen.

Test conditions: Test signals: $f_1 = 10100$ kHz, $f_2 = 10100.100$ kHz, CW, 250 Hz. Span = ± 2.5 kHz, RBW per Table 15, VBW = NAR, Averaging = 4, ATT OFF, REF LEVEL = +5 dB, preamp off. Waterfall on, speed MID (default).

To measure RBW, f_1 and f_2 are injected into the antenna input at a level sufficient to produce spikes whose vertical amplitude reaches the top of the scope grid. f_2 is moved closer to f_1 until two distinct spikes are *just* observable. To facilitate adjustment, the signal spike image can be touched to open the zoom window.

Table 15a: Spectrum Scope RBW.

RBW Setting	Measured RBW Hz
WIDE	40
MID	30
NAR	20

Figure 6a: Spectrum scope RBW (20 Hz).

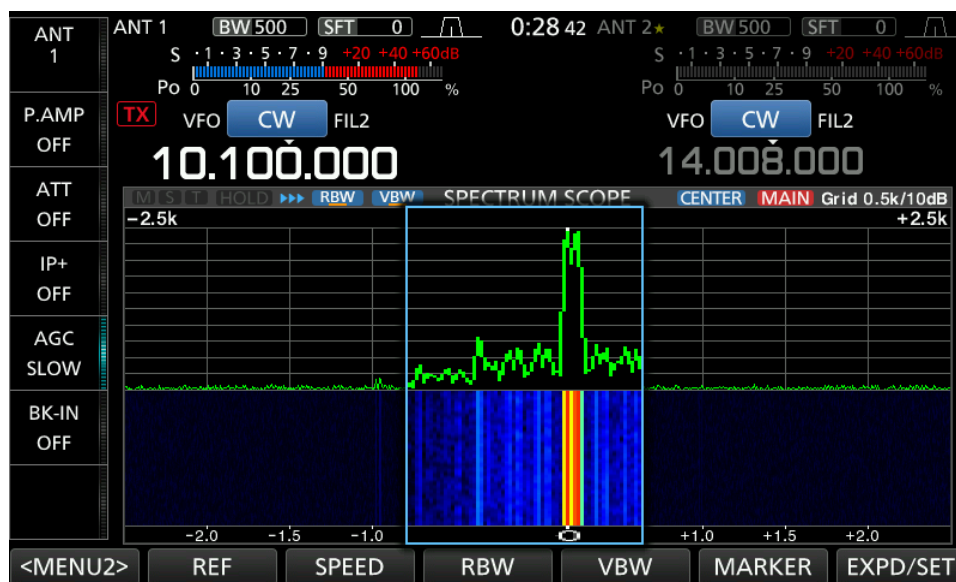

Test conditions: 14.100 MHz Span = ± 2.5 kHz, RBW = NAR, VBW = WIDE, Averaging = 4, ATT OFF, REF LEVEL = +5 dB, Waterfall off. DSP filter setting is irrelevant.

Table 15b: Spectrum Scope Sensitivity.

Minimum Visible Spike for Span = ± 2.5 kHz	
Preamp	Level dBm
Off	-120
1	-131
2	-139

Figure 6b. Spectrum scope sensitivity.

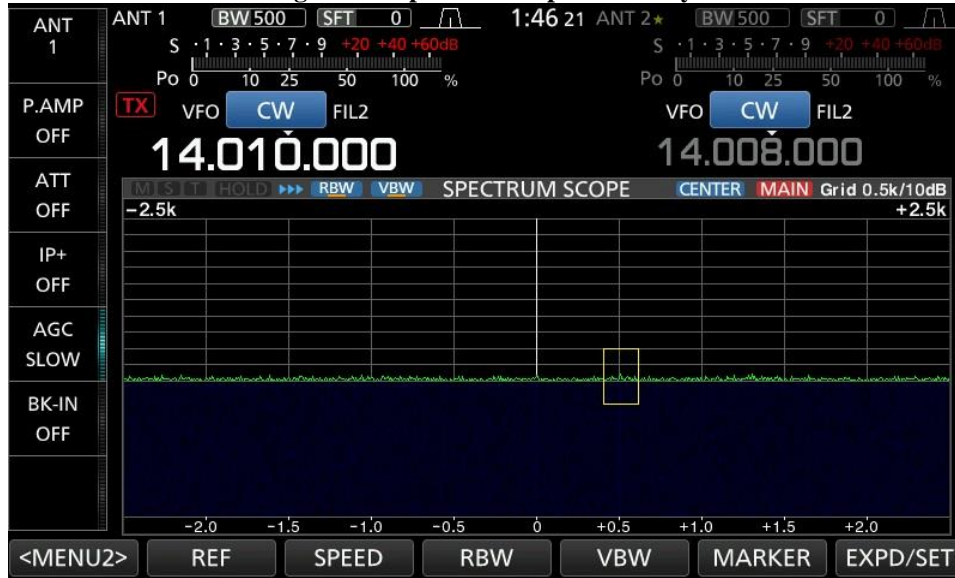

Notes on spectrum scope: A refinement to the spectrum scope would enhance its usefulness as a BITE (built-in test equipment) feature:

- An option to display a vertically expanded scope field without the waterfall when EXPD/SET is pressed, This would allow vertical expansion of the scope to fill two-thirds of the vertical field.

11: Noise Power Ratio (NPR). An NPR test is performed, using a variant of the test methodology described in detail in *Ref. 1*. The noise-loading source used for this test is a noise generator fitted with bandstop (BSF) and band-limiting filters (BLF) for the test frequencies utilized.

$$1. \text{ NPR} = P_{\text{TOT}} - \text{BWR} - \text{MDS}$$

where P_{TOT} = total noise power in dBm for 3 dB increase in audio output

$\text{BWR} = \text{bandwidth ratio} = 10 \log_{10} (B_{\text{RF}}/B_{\text{IF}})$

B_{RF} = RF bandwidth or noise bandwidth in kHz (noise source band-limiting filter)

B_{IF} = receiver IF filter bandwidth in kHz

MDS = minimum discernible signal (specified at B_{IF}), measured at 2.4 kHz SSB prior to NPR testing

NPR readings are taken with Digi-Sel ON and OFF on 1940, 3886 and 5340 kHz (bands which DigiSel covers).

Test Conditions: Receiver tuned to bandstop filter center freq. $f_0 \pm 1.5$ kHz, 2.4 kHz SSB, ATT off, max. RF Gain, Preamp off, IP+ off, NR off, NB off, Notch off, AGC-S. Test results are presented in Table 16.

Table 16a: MAIN NPR Test Results.

DUT	BSF kHz	BLF kHz	Digi-Sel	MDS dBm	P _{TOT} dBm	BWR dB	NPR dB
IC-7610	1940	60...2044	0	-126	-14.5	29.2	82
			1	-127	-5		93
	3886	60...4100	0	-127	-16.5	32.3	78
			1	-125	-4.5		88
	5340	60...5600	0	-127	-18.5	33.6	75
			1	-125	-5		86
	7600	316...8160	0	-127	-18	35.1	74
	11700	316...12360	0	-127	-16	37.0	74
	16400	316...17300	0	-127	-17	38.5	72

Table 16b: SUB NPR Test Results.

DUT	BSF kHz	BLF kHz	Digi-Sel	MDS dBm	P _{TOT} dBm	BWR dB	NPR dB
IC-7610	1940	60...2044	0	-125	-14.5	29.2	81
			1	-126	-5		92
	3886	60...4100	0	-127	-16	32.3	78
			1	-124	-4.5		87
	5340	60...5600	0	-128	-18.5	33.6	76
			1	-125	-4		87
	7600	316...8160	0	-126	-18	35.1	73
	11700	316...12360	0	-125	-16	37.0	72
	16400	316...17300	0	-125	-17	38.5	70

Note on NPR test: As is typical of a direct-sampling receiver, it was determined that the noise loading drove the ADC into clipping before the AF noise output increased by 3 dB. Thus, an alternative method is used, whereby the noise loading is set to 1 dB below clipping (-1 dBFS) and the NPR calculated using Equation 1 above.

By reducing the frequency range to which the ADC is exposed, DigiSel improves NPR by ≈ 10 dB. IP+ does not affect NPR readings.

12: Aliasing rejection. The IC-7610 Nyquist frequency (one-half the sampling rate) is 61.44 MHz. In this test, a test signal at 75.000 MHz is to the antenna port and the IC-7610 is tuned to its alias frequency (47.88 MHz). The test signal power is increased sufficiently to raise the AF output by 3 dB.

Test Conditions: Receive frequency 47.880 MHz, CW, 500 Hz. Test signal at 75.000 MHz applied to ANT input. ATT off, max. RF Gain, Preamp off, IP+ off, NR off, NB off, Notch off, AGC-S. RMS voltmeter connected to LINE OUT.

Test signal level = -75 dBm for 3 dB AF level increase. MDS = -129 dBm.

Test Result: Aliasing rejection = $-75 - (-129) = 54$ dB.

13: Receiver latency. Latency is the transit time of a signal across the receiver, i.e. the time interval between arrival of the signal at the antenna input and appearance of the demodulated signal at the AF output. Various aspects of receiver design exert a major influence on latency; among these are DSP speed and group delay across selectivity filters. As the DSP speed is fixed by design, we measure latency for various filter configurations (bandwidth and shape factor). Figure 7 illustrates an example.

To measure latency, a pulse generator feeds repetitive pulses via a hybrid splitter to the DUT antenna input and also to Channel 1 of a dual-trace oscilloscope. Channel 2 is connected to the DUT AF output. The scope is triggered from the pulse generator's trigger output. The time interval between the pulses displayed on Channels 1 and 2 is recorded for each test case.

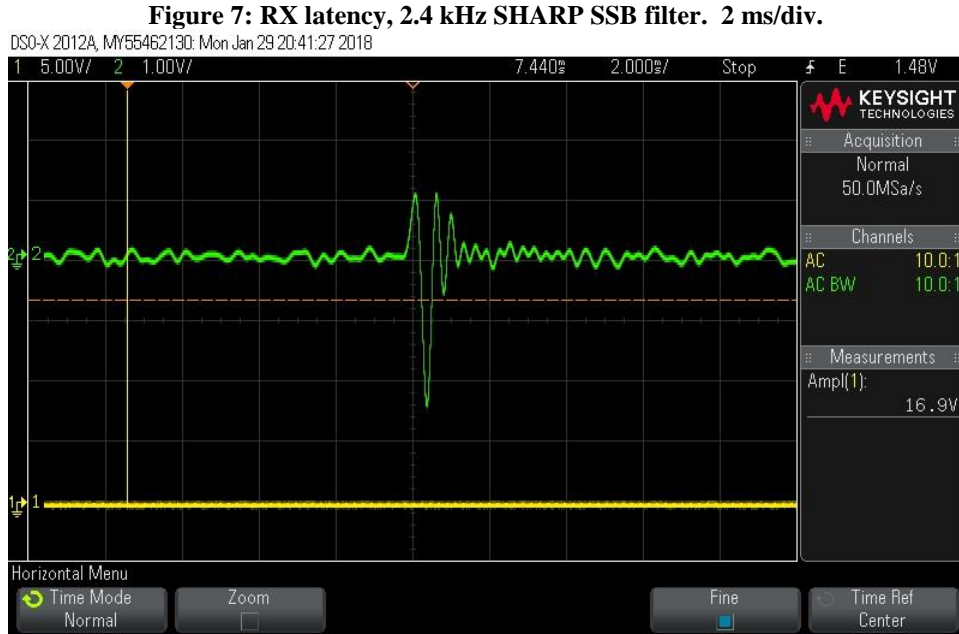

Test Conditions: 3.6 MHz, Preamp off, AGC Fast, IP+ off, max. RF Gain, ATT off, NR off, NB off. Pulse generator output 16V_{p-p}. Step attenuator between splitter output and DUT ANT1 set at 60 dB. Pulse duration 60 ns, period 0.2 s.

Table 17: Receiver latency test results.

Mode	Filter BW kHz	Shape Factor	Latency ms
LSB	3.6	Soft/Sharp	7.4
	2.4		7.6
	1.8		7.8
CW	1.2	Soft/Sharp	7.9
	0.5	Sharp	12.3
		Soft	12.5
	0.25	Sharp	17.0
Soft		14.0	
RTTY	2.4	Fixed	9.2
	0.5		12.2
	0.25		12.0

14: NR noise reduction, measured as SINAD. This test is intended to measure noise reduction on SSB signals close to the noise level. A distortion meter is connected to LINE OUT. The test signal is offset 1 kHz from the receive frequency to produce a test tone, and RF input power is adjusted for a 6 dB SINAD reading. NR is then turned on, and SINAD read at 30%, 50% and 60% (max.) NR settings.

Test conditions: 14.1 MHz USB, 2.4 kHz Sharp, AGC-M, preamp off, IP+ off, max. RF Gain, ATT off, NB off, Twin PBT neutral. Test signal at -121 dBm (6 dB SINAD)

Table 18: Noise reduction vs. NR setting.

NR Setting	0	1	2	3	4	5	6	7	8	9	10	11	12	13	14	15
SINAD dB	6	7	7	8	8	10	11	13	15	15	15	15	15	15	16	16

This shows an S/N improvement of 10 dB with NR at maximum for an SSB signal \approx 12 dB above MDS. This is an approximate measurement, as the amount of noise reduction is dependent on the original signal-to-noise ratio.

15: Audio THD. In this test, an audio distortion analyzer is connected to the external speaker output. An 8 Ω resistive load is connected across the analyzer input. An S7 to S9 RF test signal is applied to the antenna input, and the main tuning is offset by 1 kHz to produce a test tone. The audio voltage corresponding to 10% THD is then measured, and the audio output power calculated.

Test Conditions: 14.100 MHz, 3 kHz USB, AGC-F, ATT off, NR off, NB off, Preamp off. Offset tuning by -1 kHz.

Test Result: Measured audio output voltage = 5.00V rms.

Thus, audio power output = $\sqrt{[(4)^2/8]} = \mathbf{2.0W}$ in 8 Ω at 1 kHz. (Spec. is 2W).

16: Spurious signals (“birdies”). The following spurious signals were observed on MAIN receiver with the ANT input terminated in 50 Ω . *Note that all these signals except for the 95 kHz spur are very weak, and none of them falls into an amateur band.*

Table 19: Spurious signals in MAIN receiver.

Freq. kHz	Band	Mode	Signal Type	S-meter rdg.	Remarks
38	LF	USB	Tone	S0	Weak
47		USB	Warble	S0	Weak
95		USB	Tone	S3	Steady
191		USB	Tone	S0	Weak beat note
255		USB	Tone	S0	Weak fluctuating
319		USB	Tone	S0	Weak fluctuating
383		USB	Tone	S0	Weak beat note
447		USB	Tone	S0	Weak beat note
1364	MF	USB	Tone	S5	Steady
10922	HF	USB	Tone	S0	Weak
45762	VHF Lo	USB	Tone	S0	Weak
58880		USB	Tone	S1	Steady

B. Transmitter Tests

Note: The firmware was upgraded to V1.05 at the start of transmitter testing.

17: CW Power Output. In this test, the RF power output into a 50Ω load is measured at 3.6, 14.1, 28.1 and 50.1 MHz in RTTY mode, at a primary DC supply voltage of +13.8V. A thermocouple-type power meter is connected to the IC-7610 RF output via a 50 dB power attenuator.

Table 20: CW Power Output.

Freq. MHz	3.6	14.1	28.1	50.1
P _O W	114.	109	104	106
% RF PWR	100	100	100	100
I _{DC} at 100W, A	17.3	17.6	18	17.7

Drive Gain = 50%.

RX/Standby: I_{DC} = 2.1A.

Emergency Tune (typical): 3.6 MHz, P_O = 58W, I_{DC} = 14A.

QRP (5W nominal): 3.6 MHz, P_O = 5W. % RF PWR = 6. I_{DC} = 7.2A.

18: SWR Meter Scale. The SWR Graph feature was tested with 50Ω and 75Ω resistive loads connected in turn to ANT1. The RF POWER setting remained unchanged when switching loads.

Test Conditions: 3.6 MHz RTTY. P_O = 5W into 50Ω and 75Ω terminations.

Test Results: 50Ω: SWR reads 1:1. 75Ω: SWR reads 1.5:1.

19: SSB Peak Envelope Power (PEP). Here, an oscilloscope is terminated in 50Ω and connected to the IC-7610 RF output via a 50 dB high-power attenuator. At 100W CW, the scope vertical gain is adjusted for a peak-to-peak vertical deflection of 6 divisions.

Test Conditions: USB mode, HM-219 mic connected, 100W PEP, Mic Gain 50%, COMP OFF/ON, TBW = WIDE, COMP at 2 (≈ 6 dB compression on voice peaks), SSB TX Bass/Treble set at 0 dB (default), supply voltage +13.8V.

Speak loudly into the microphone for full-scale ALC reading. Figures 8 & 9 show the envelope for 100W PEP, without and with compression respectively. ± 3 vertical divisions = 100W. Check envelope for overshoot. Repeat test with 50W and 20W PEP and check envelope for overshoot.

Test Results: 100W PEP was achieved with no sign of flat-topping or envelope distortion. Only one small initial overshoot event was observed. See Table 21.

Table 21: Initial SSB overshoot.

PEP output W	Time t ₀ + ms	Overshoot dB
100	30	≈ 0.6
50	30	≈ 0.8
20	20	≈ 1

Figure 8: 100W PEP speech envelope, no compression.

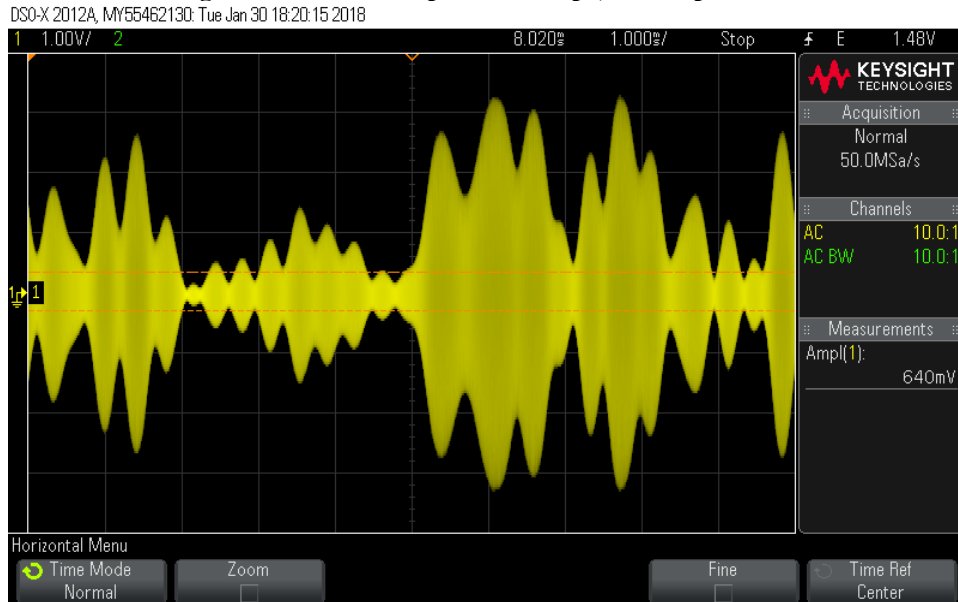
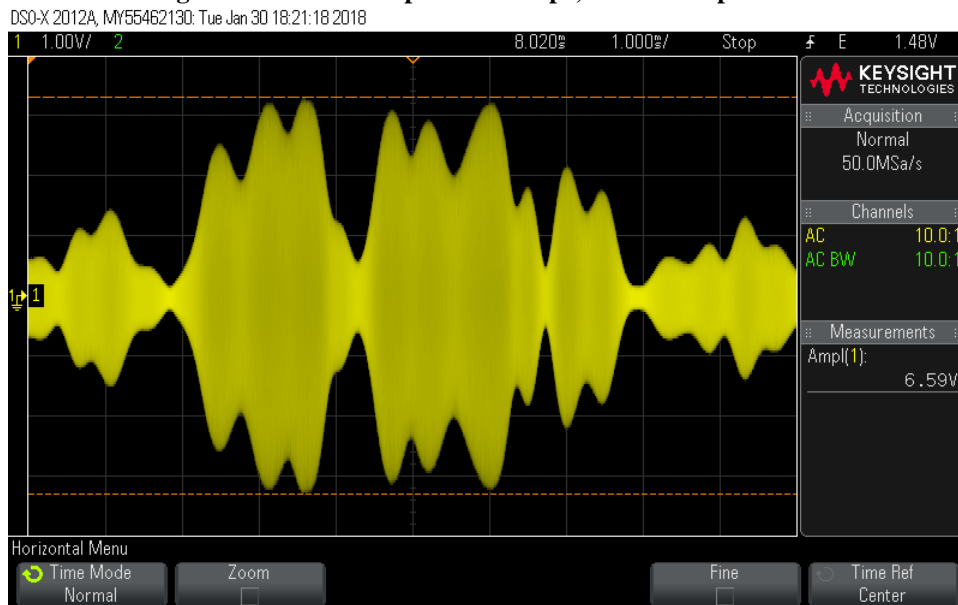

Figure 9: 100W PEP speech envelope, ≈ 6 dB compression.



20: SSB ALC overshoot test with white noise. A test was conducted in which white noise was applied via the USB port, and the RF envelope observed on an oscilloscope terminated in 50 Ω and connected to the IC-7610 RF output via a 50 dB high-power attenuator.

Test Conditions: 14100 kHz USB, COMP off, DATA OFF MOD = USB, USB MOD Level = 50% (default). Test signal: white noise. WIDE TBW (default value) selected. Supply voltage +13.8V.

Set $P_o = 100$ W in RTTY mode. Select USB, then adjust USB Audio Codec device volume on computer for 50% ALC reading.

Test Result: No ALC overshoot was observed.

Figure 10a: 100W white noise test.

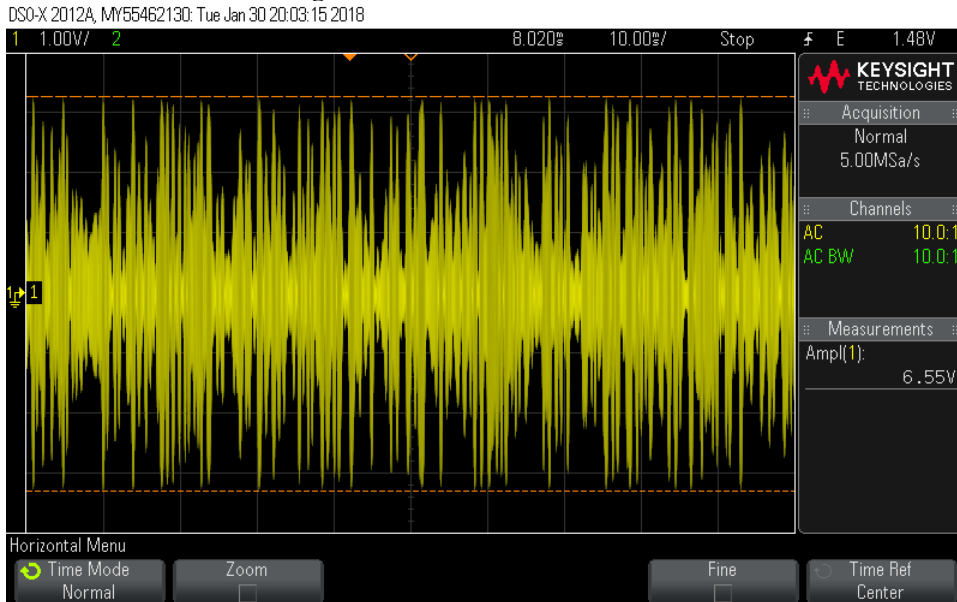
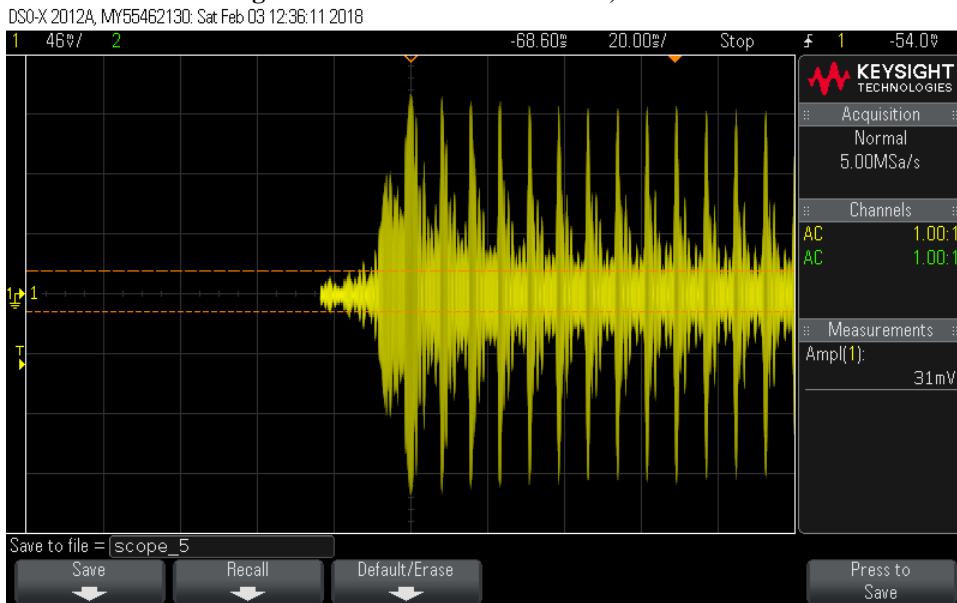

Figure 10b: Initial SSB overshoot, 50W PEP.



21: ALC Compression Check. In this test, a 2-tone test signal is applied to the USB port from a tone-generator program running on a laptop computer. An oscilloscope is connected to the IC-7610 RF output via a 50 dB high-power attenuator. RF Power is initially adjusted for 100W output in RTTY mode.

Test Conditions: 14100 kHz USB, COMP off, DATA OFF MOD = USB, USB MOD Level = 50% (default). Test tones: 700 and 1700 Hz, at equal amplitudes. WIDE TBW (default value) selected. Supply voltage +13.8V.

Test Result: No flat-topping of the 2-tone envelope was observed (see Figure 11.)

Figure 11: 2-tone envelope, 100W PEP.

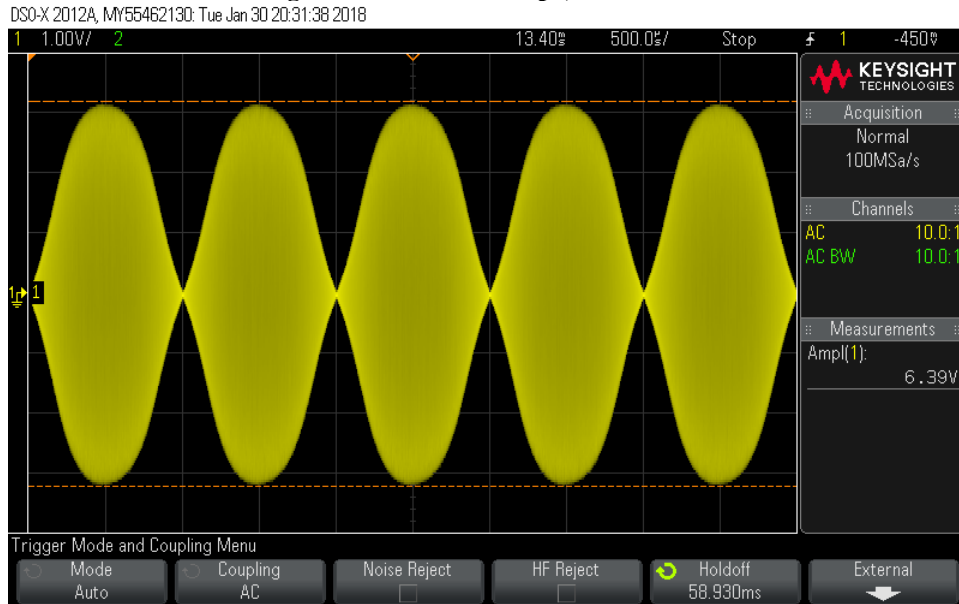

22: Transmitter 2-tone IMD Test. In this test, a 2-tone test signal is applied to the USB port from a tone-generator program running on a laptop computer. A spectrum analyzer is connected to the IC-7610 RF output via a 60 dB high-power attenuator. RF Power is initially adjusted for rated CW output on each band in turn.

Test Conditions: DC supply 13.8V, measured at DC power socket. 3.6, 14.1, 28.1 and 50.1 MHz USB, DATA OFF MOD = USB, USB MOD Level = 50% (default). Test tones: 700 and 1700 Hz, at equal amplitudes. The -10 dBm reference level RL equates to rated CW output (= 0 dBc).

On computer, adjust USB Audio Codec device volume for 100W PEP (each tone at -6 dBc). Figures 12 through 15 show the two test tones and the associated IMD products for each test case.

Note on 6m IMD3: On 6m, the measured IMD3 exceeds by 1 dB the ITU-R -25 dBc guideline for single-channel J3E (SSB voice), per Recommendation SM.326-7 Section 1.2.3.

22a: Noise IMD Test. This test is similar to Test 22, except that a white-noise baseband is applied to the USB port from the tone-generator program. Spectrograms are captured at 100W and 25W PEP, as shown in Figure 16. Note that the IMD skirts are steeper at the lower power level. Test results are summarized in Table 22.

Figure 12: Spectral display of 2-tone IMD at 3.6 MHz, 100W PEP.

IC-7610 80m 100W PEP TX IMD 30012018

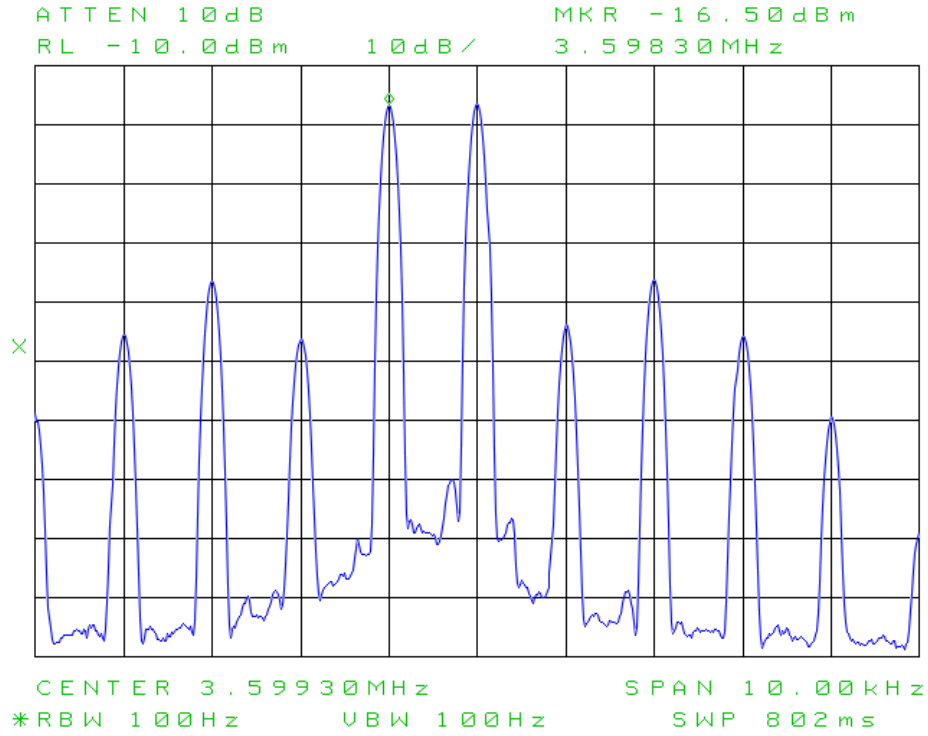

Figure 13: Spectral display of 2-tone IMD at 14.1 MHz, 100W PEP.

IC-7610 20m 100W PEP TX IMD 30012018

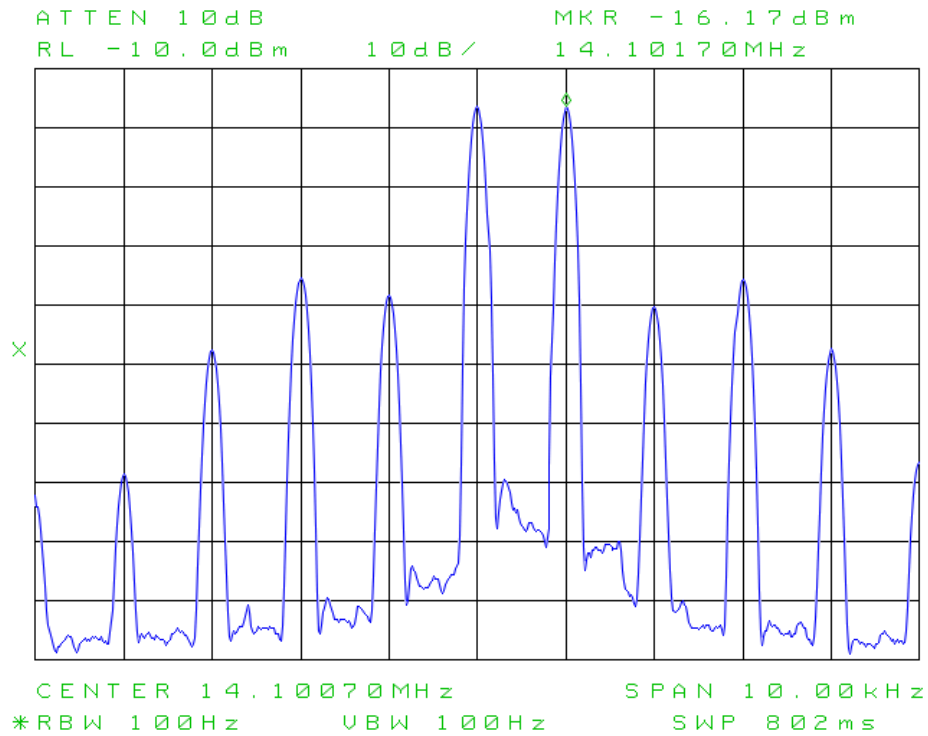

Figure 14: Spectral display of 2-tone IMD at 28.1 MHz, 100W PEP.

IC-7610 10m 100W PEP TX IMD 30012018

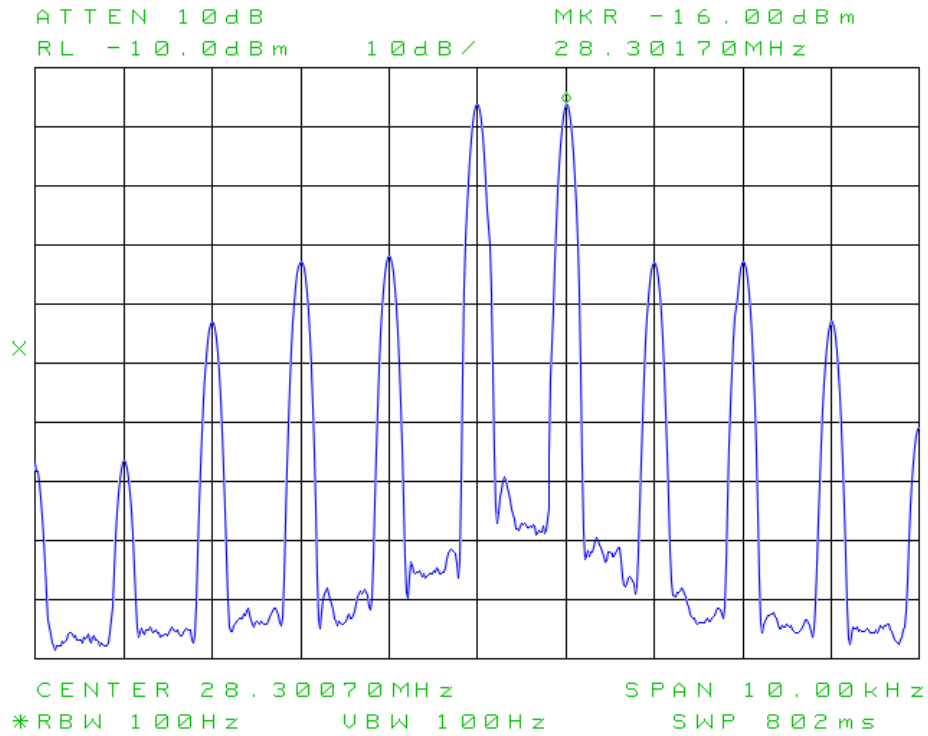

Figure 15: Spectral display of 2-tone IMD at 50.1 MHz, 100W PEP.

IC-7610 6m 100W PEP TX IMD 30012018

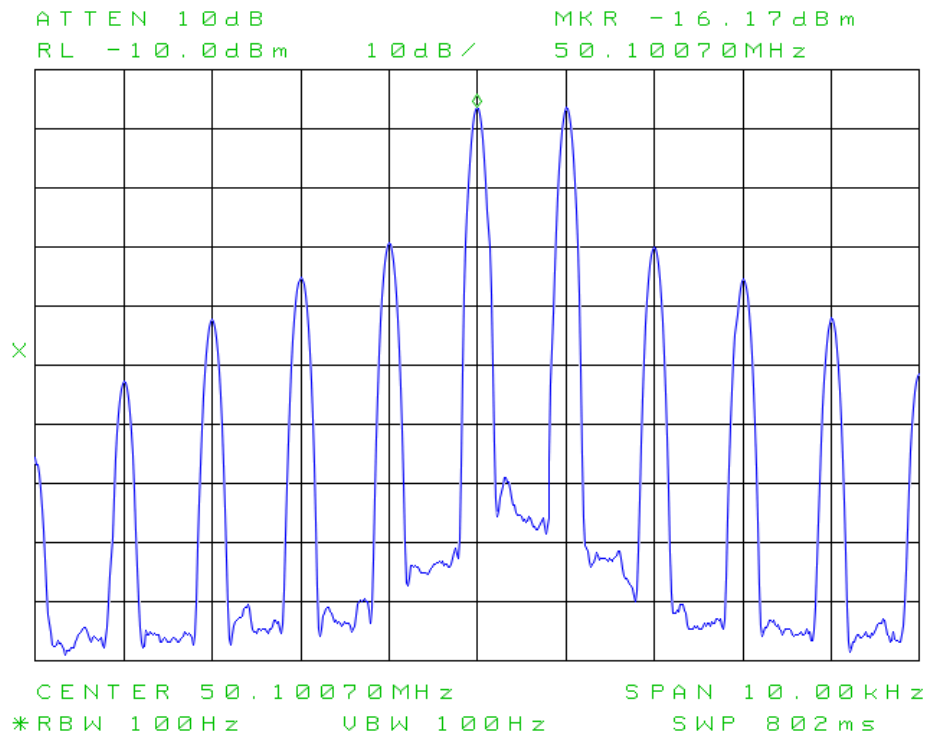

Figure 16: 20m noise modulation, showing IMD skirts.

IC-7610 20m NOISE IMD:B: 100W R: 25W 30012018

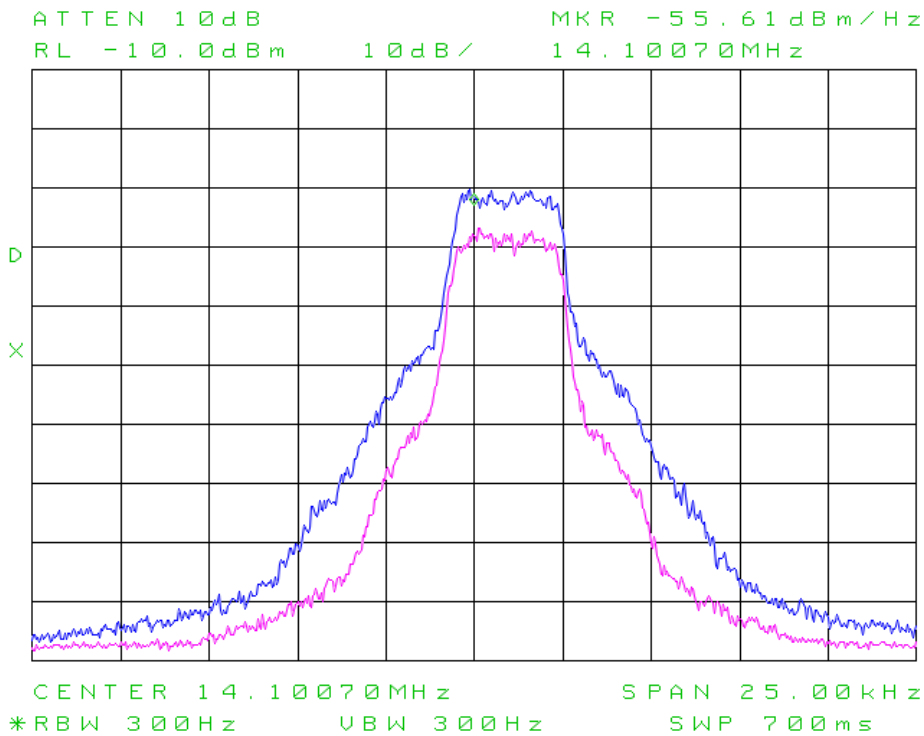

Table 22. 2-tone TX IMD.

2-tone TX IMD Products at Rated P _o				
IMD Products	Rel. Level dBc (0 dBc = 1 tone)			
Freq. MHz	3.6	14.1	28.1	50.1
IMD3 (3 rd -order)	-39	-34	-28	-24
IMD5 (5 th -order)	-30	-30	-28	-30
IMD7 (7 th -order)	-40	-42	-38	-37
IMD9 (9 th -order)	-54	-62	-65	-46
Add -6 dB for IMD referred to 2-tone PEP				

23: AM sidebands and THD with single-tone modulation. As in Test 26 above, the spectrum analyzer is connected to the IC-7610 RF output via a 50 dB high-power attenuator. On the IC-7610, RF Power is adjusted for 25W resting carrier. A 1 kHz test tone is applied to the USB port from the tone-generator program running on the laptop computer. The tone level is adjusted for 90% modulation (sidebands at -7 dBc). The spectrum analyzer records the carrier and sideband parameters.

Test Conditions: 14100 kHz AM, 25W carrier output, DATA OFF MOD = USB, USB MOD Level = 50% (default). On computer, adjust USB Codec device volume for -7 dBc test tone level (90% modulation.) Figure 17 shows the carrier and sideband levels. Calculated THD \approx 2%.

Figure 17: AM Sidebands for 90% Modulation.

IC-7610 20m AM Sidebands 90% Mod 25W CXR 310118

DISCRETE SIDEBAND SEARCH RESULTS

CARRIER FREQ: 14.10 MHz
CARRIER POWER: -15.8 dBm

OFFSET FREQ	- OFFSET dBc	+ OFFSET dBc
.998 kHz	-6.8	-6.8
1.997 kHz	-38.2	-41.5
2.996 kHz	-33.7	-33.3
4.004 kHz	-55.5	-54.5
5.003 kHz	-55.0	-54.8

FOUND: 5 SETS OF SIDEBANDS

24: Transmitter harmonics & spectral purity. Once again, the spectrum analyzer is connected to the IC-7610 RF output via a 60 dB high-power attenuator. RF Power is adjusted for rated CW output on each band in turn. The 0 dBm reference level equates to 100W. The spectrum analyzer's harmonic capture utility is started.

Test Conditions: 3.6, 14.1, 28.1, 50.1 MHz, RTTY, rated output to 50Ω load. Utility start and stop frequencies are configured as shown in Figures 19 through 26 inclusive.

Harmonic data and spur sweeps are presented for HF/6m. It will be seen that harmonics and spurs are well within specifications.

Figure 18.

IC-7610 80m HARMONICS 100W 31012018

HARMONIC MEASUREMENT RESULTS

FUNDAMENTAL SIGNAL: 3.600 MHz
-10.3 dBm

HARMONIC	LEVEL dBc	FREQUENCY
2	-81.5 *	7.200 MHz
3	-76.3	10.80 MHz
4	-82.0	14.40 MHz
5	-74.7	18.00 MHz
6	-88.5	21.60 MHz
7	-96.2	25.20 MHz
8	-97.3	28.80 MHz

* MEASURED LEVEL MAY BE NOISE OR LOST SIGNAL.

TOTAL HARMONIC DISTORTION = 0 %
(OF HARMONICS MEASURED)

Figure 19.

IC-7610 80m SPURS/HARMONICS 100W 31012018

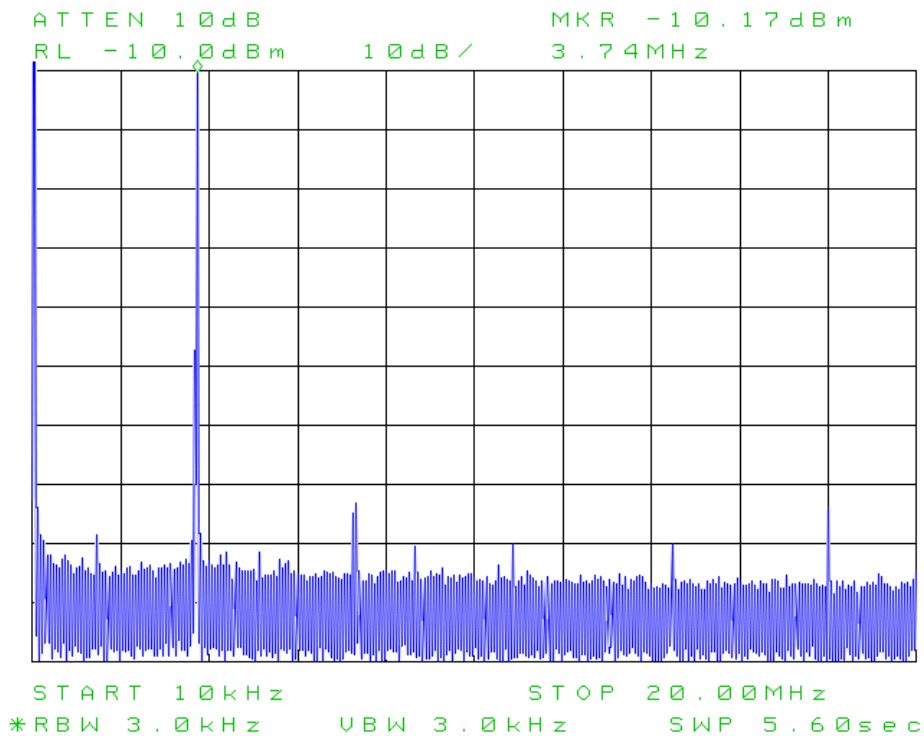

Figure 20.

IC-7610 20m HARMONICS 100W 31012018

HARMONIC MEASUREMENT RESULTS

FUNDAMENTAL SIGNAL: 14.10 MHz
-9.8 dBm

HARMONIC	LEVEL dBc	FREQUENCY
2	-72.7	28.20 MHz
3	-65.0	42.30 MHz
4	-101.3 *	56.40 MHz
5	-90.2	70.50 MHz
6	-98.0	84.60 MHz
7	-107.2 *	98.70 MHz
8	-95.0	112.8 MHz

* MEASURED LEVEL MAY BE NOISE OR LOST SIGNAL.

TOTAL HARMONIC DISTORTION = .1 %
(OF HARMONICS MEASURED)

Figure 21.

IC-7610 20m SPURS/HARMONICS 100W 31012018

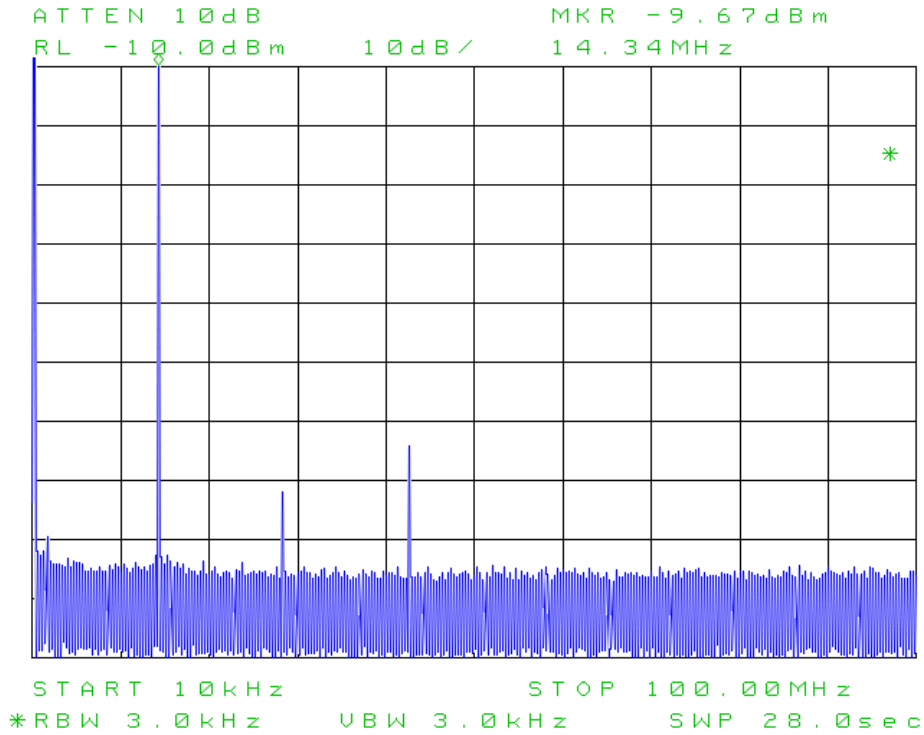

Figure 22.

IC-7610 10m HARMONICS 100W 31012018

HARMONIC MEASUREMENT RESULTS

FUNDAMENTAL SIGNAL: 28.30 MHz
-10.0 dBm

HARMONIC	LEVEL dBc	FREQUENCY
2	-66.2	56.60 MHz
3	-72.8	84.90 MHz
4	-63.5	113.2 MHz
5	-74.3	141.5 MHz
6	-79.3	169.8 MHz
7	-98.0	198.1 MHz
8	-85.8	226.4 MHz

TOTAL HARMONIC DISTORTION = .1 %
(OF HARMONICS MEASURED)

Figure 23.

IC-7610 10m SPURS/HARMONICS 100W 31012018

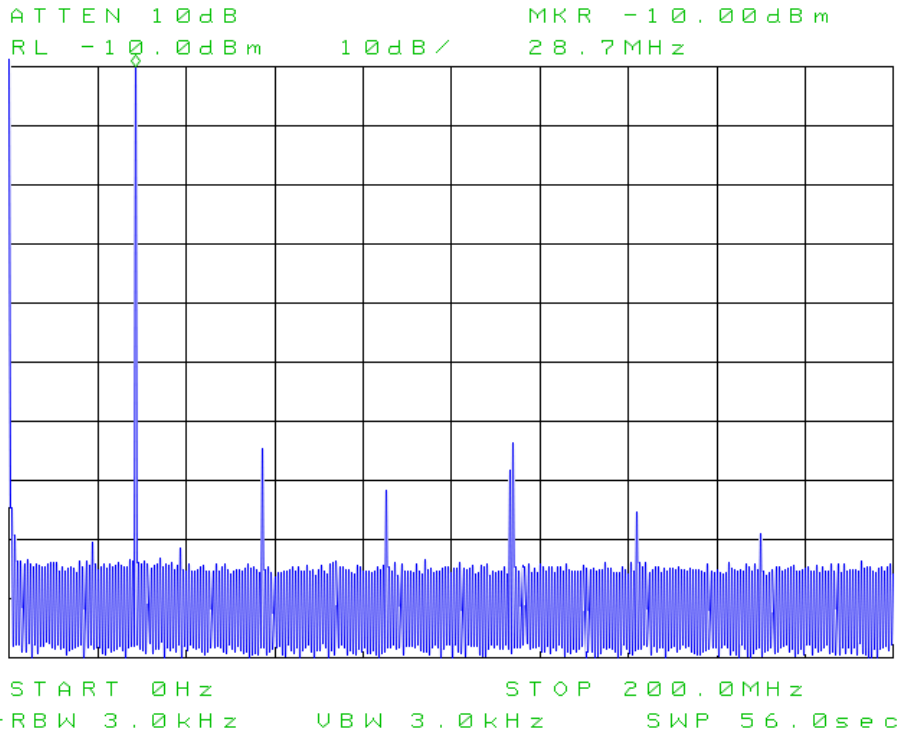

Figure 24.

IC-7610 6m HARMONICS 100W 31012018

HARMONIC MEASUREMENT RESULTS

FUNDAMENTAL SIGNAL: 50.10 MHz
-9.8 dBm

HARMONIC	LEVEL dBc	FREQUENCY
2	-78.3	100.2 MHz
3	-88.3 *	150.3 MHz
4	-85.8	200.4 MHz
5	-98.8	250.5 MHz
6	-98.3	300.6 MHz
7	-104.2 *	350.7 MHz
8	-108.2 *	400.8 MHz

* MEASURED LEVEL MAY BE NOISE OR LOST SIGNAL.

TOTAL HARMONIC DISTORTION = 0 %
(OF HARMONICS MEASURED)

Figure 25.

IC-7610 6m SPURS/HARMONICS 100W 31012018

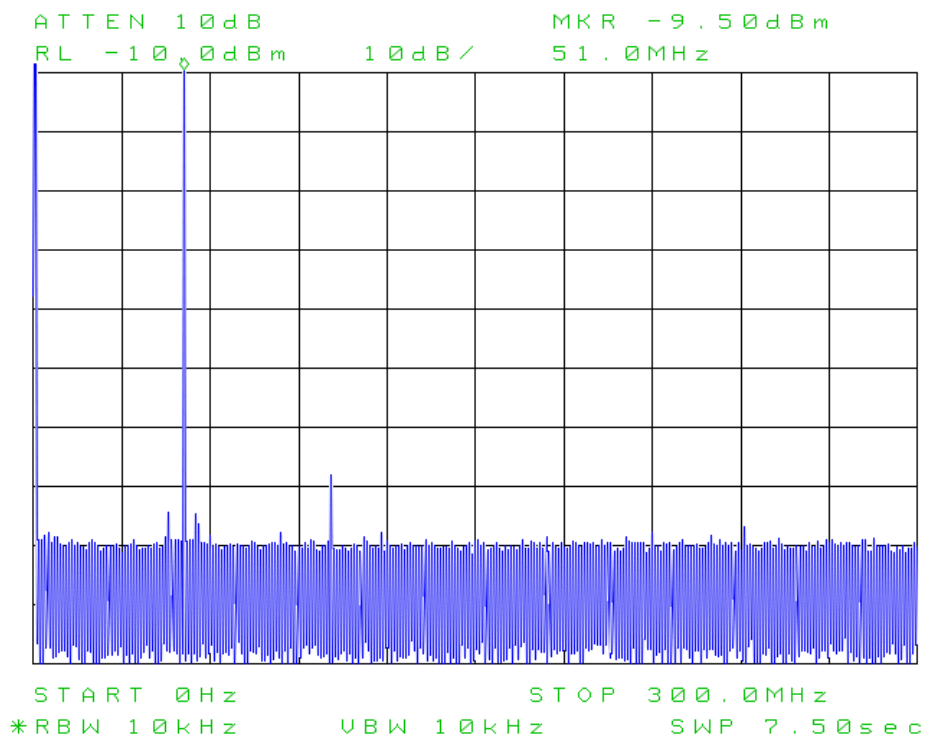

25: Transmitted phase noise. A Rohde & Schwarz FSUP 8 signal source analyzer is connected to the IC-7610 RF output via a 40 dB high-power attenuator. Next, a phase noise sweep is run at 100W output on each selected band in turn at 10 Hz – 500 kHz or 10 Hz – 1 MHz offset.

Test Conditions: 3.6, 14.1, 28.1 and 50.1 MHz RTTY, 100W to 50Ω load. Input level to FSUP: +10 dBm. FSUP configured for AUTO level, 5 dB default attenuation, min. offset 10 Hz.

Figure 26a: TX phase noise, 80m.

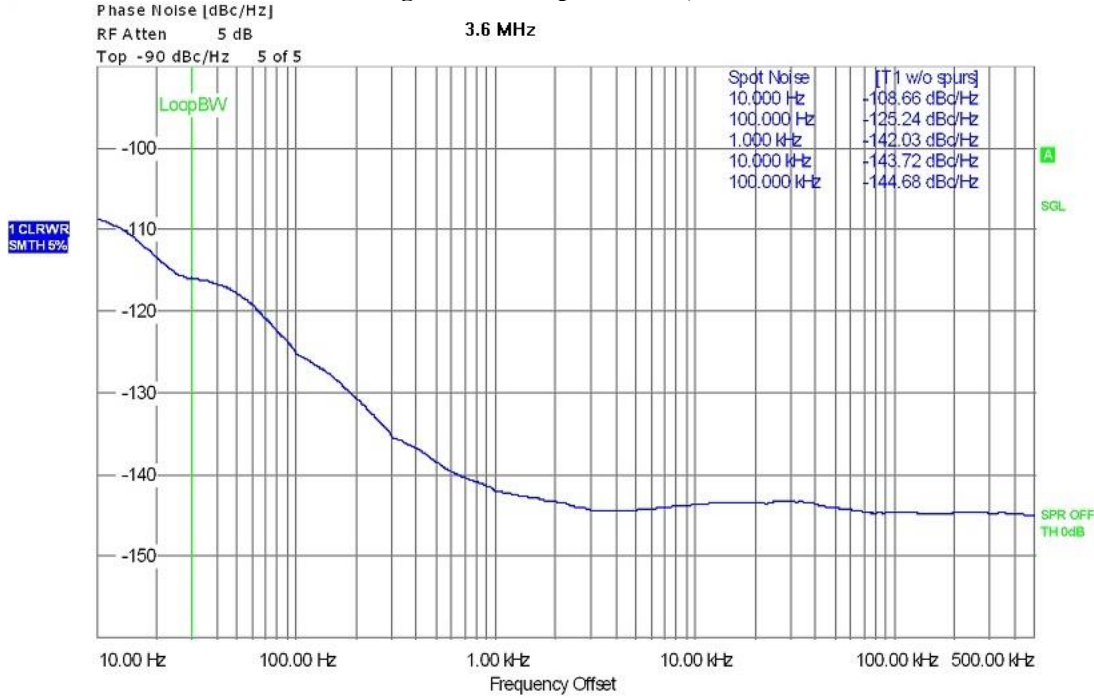

Figure 26b: TX phase noise, 20m.

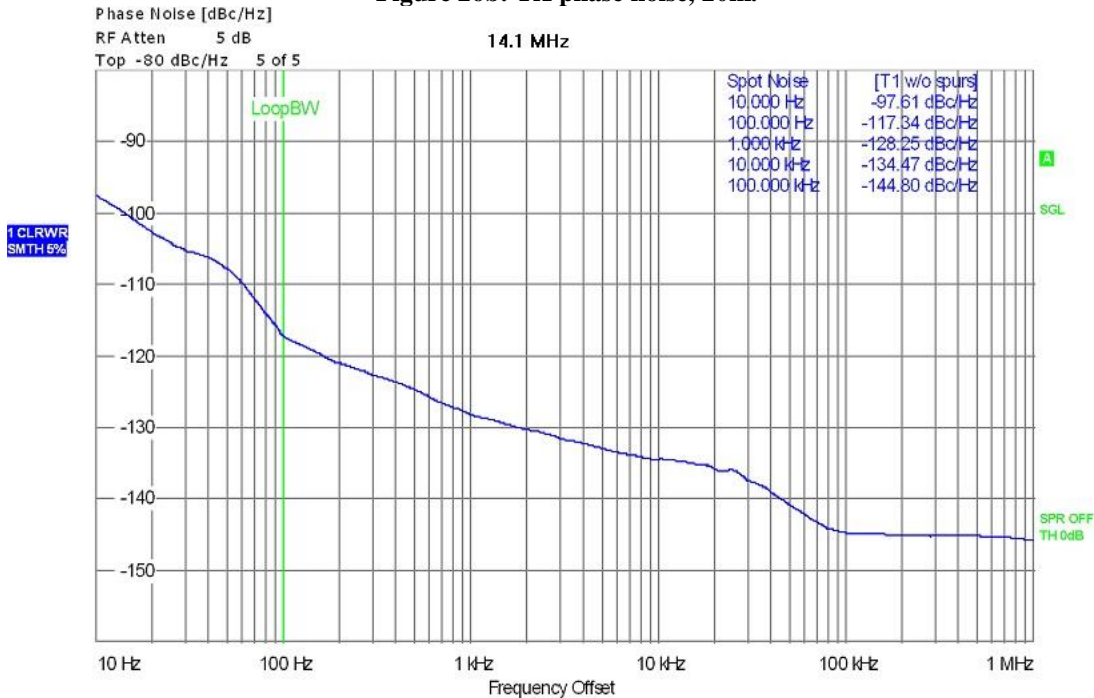

Figure 26c: TX phase noise, 10m.

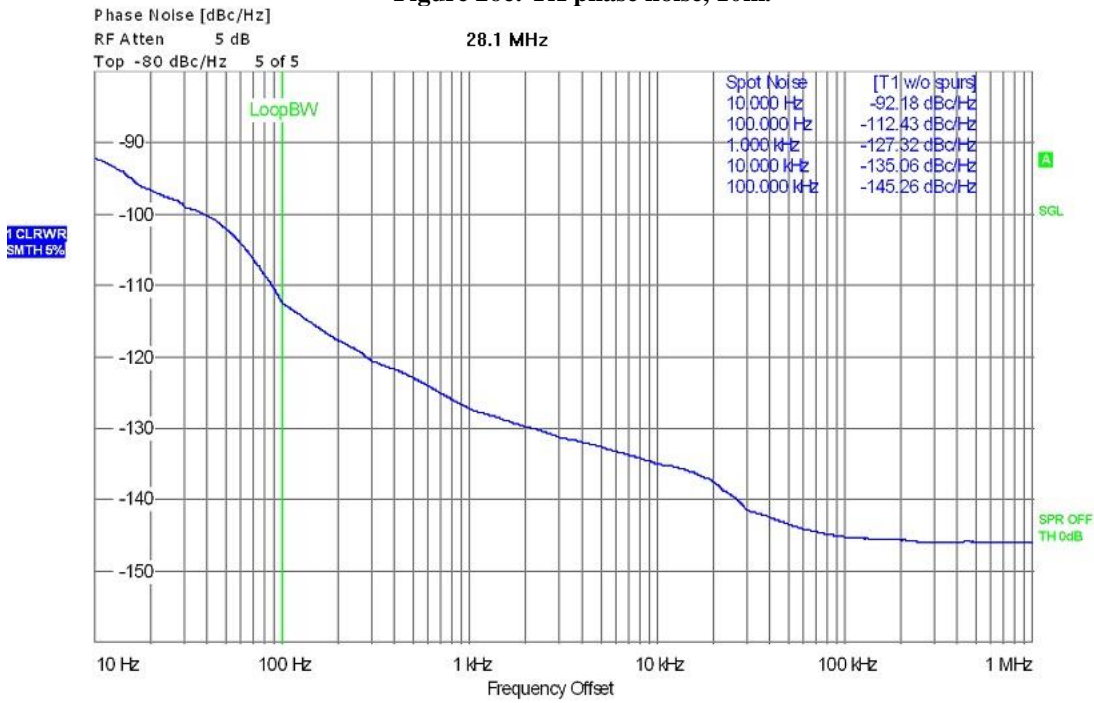
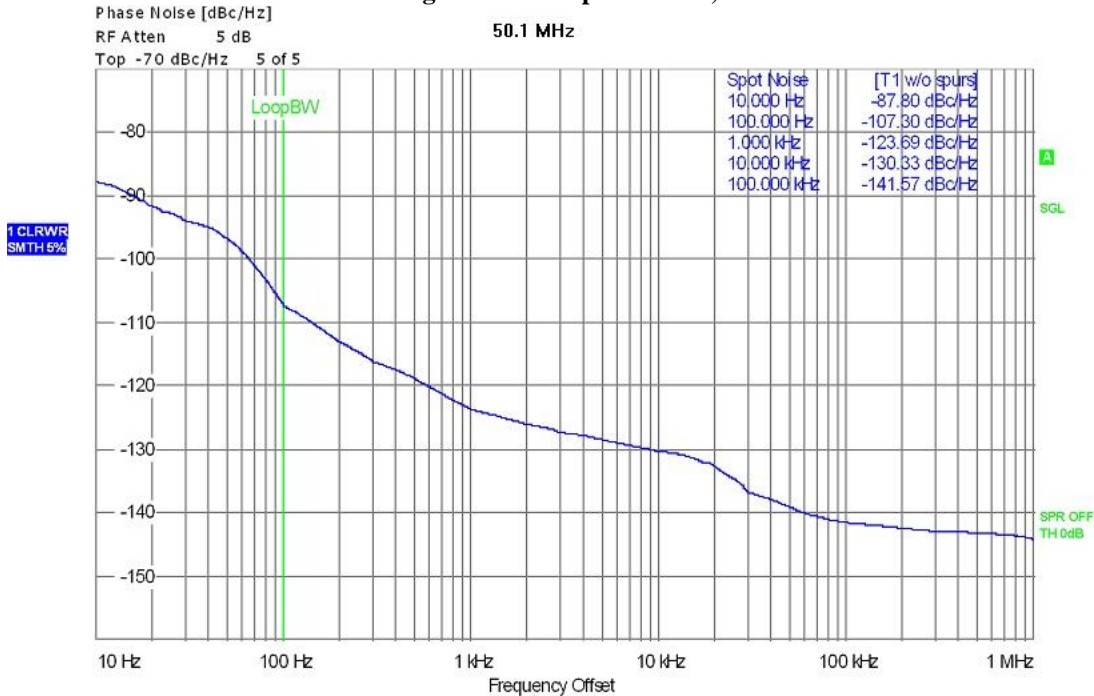

Figure 26d: TX phase noise, 6m.



26: Spectral display of CW keying sidebands. The spectrum analyzer is connected to the IC-7610 RF output via a 60 dB high-power attenuator. The -10 dBm reference level equates to 100W. A series of dits is transmitted at the highest keying speed.

Test Conditions: 14.1 MHz CW, 100W output to 50Ω load. Keying speed 48 wpm (KEY SPEED max.) using internal keyer. Spectrum analyzer RBW is 10 Hz, video-averaged; sweep time < 4 sec. Figures 27 and 28 show the transmitter output ±5 kHz from the carrier at 2/4 and 6/8 ms rise-time, respectively.

Figure 27: Keying sidebands at 48 wpm, 2/4 ms rise-time 14.1 MHz, 100W.

IC7610 CW Sidebands BLU:4ms UI0:2ms 48wpm 310118

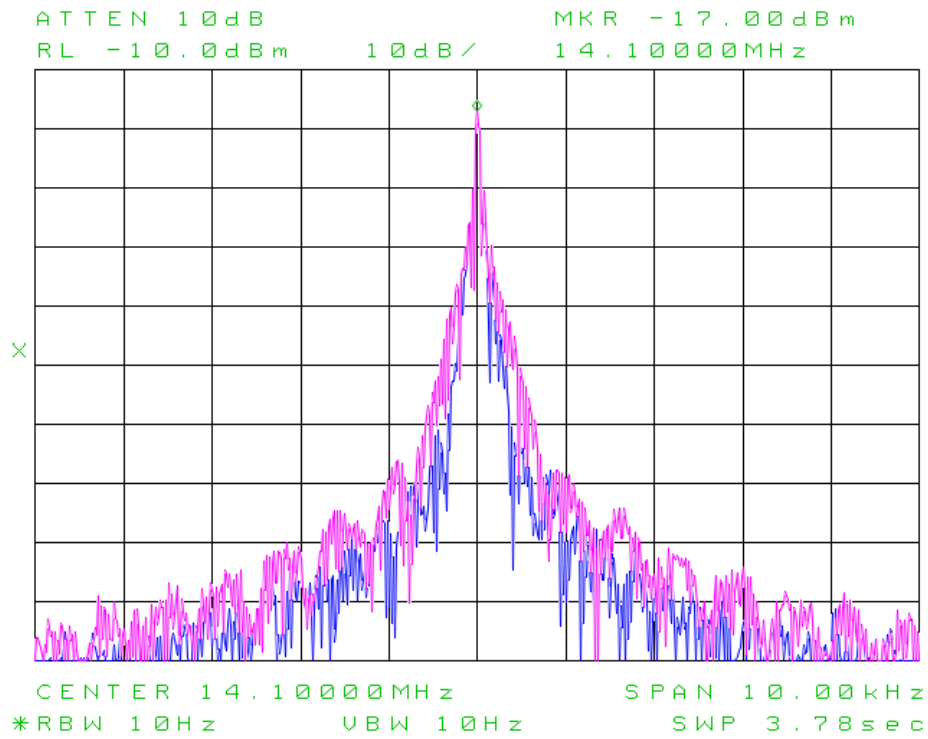
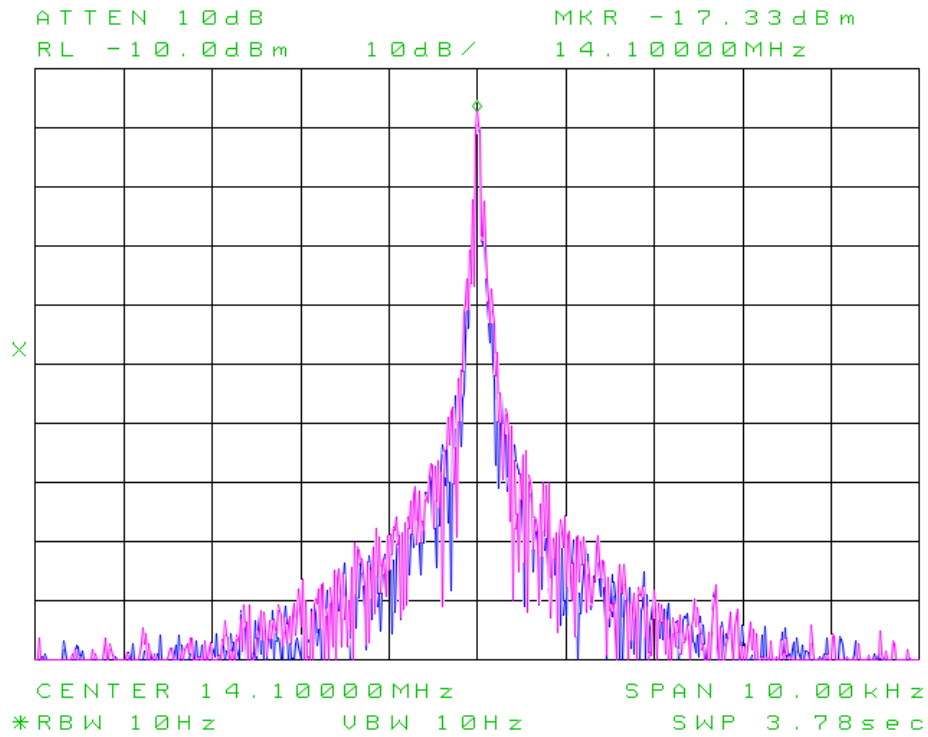

Figure 28: Keying sidebands at 48 wpm, 6/8 ms rise-time 14.1 MHz, 100W.

IC7610 CW Sidebands BLU:8ms UI0:6ms 48wpm 310118



26a: CW keying envelope. The oscilloscope is terminated in 50Ω and connected to the IC-7610 RF output via a 50 dB high-power attenuator. A series of dits is transmitted from the internal keyer at the highest keying speed (48 wpm) in semi-break-in mode (BK).

Test Conditions: 14.1MHz CW, 100W output to 50Ω load. CW rise time = 4 ms (default), TX DELAY (HF & 50M) OFF.

Figure 29: Keying envelope at 48 wpm, 2 ms rise time.

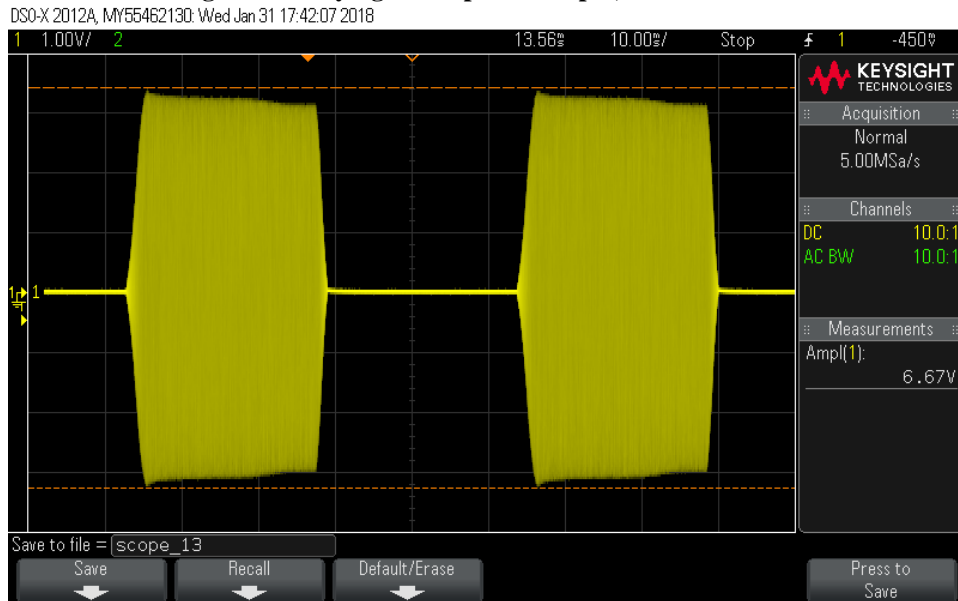

Figure 30: Keying envelope at 48 wpm, 4 ms rise time, 2 ms/div.

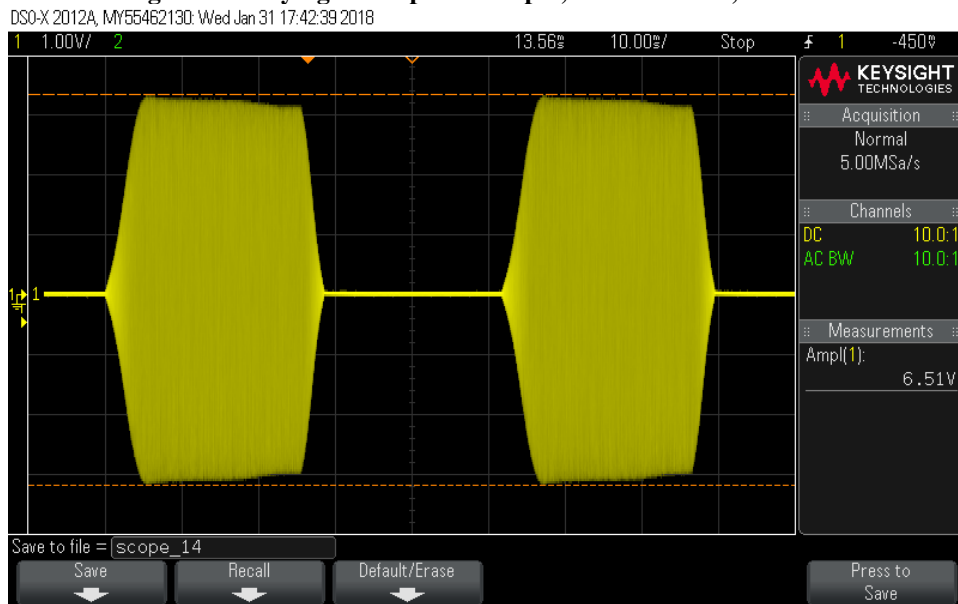

Figure 31: Keying envelope at 48 wpm, 6 ms rise time, 2 ms/div.

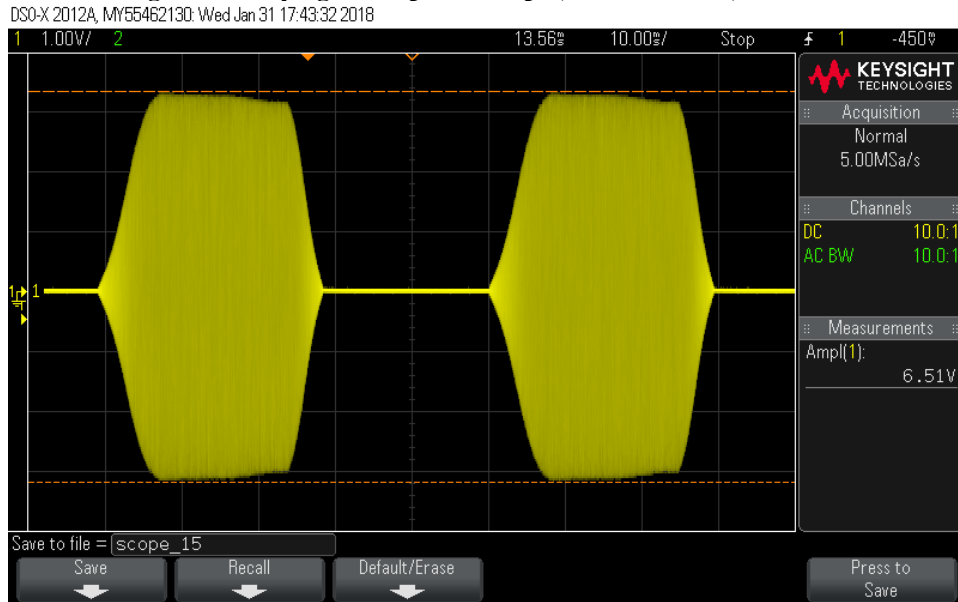
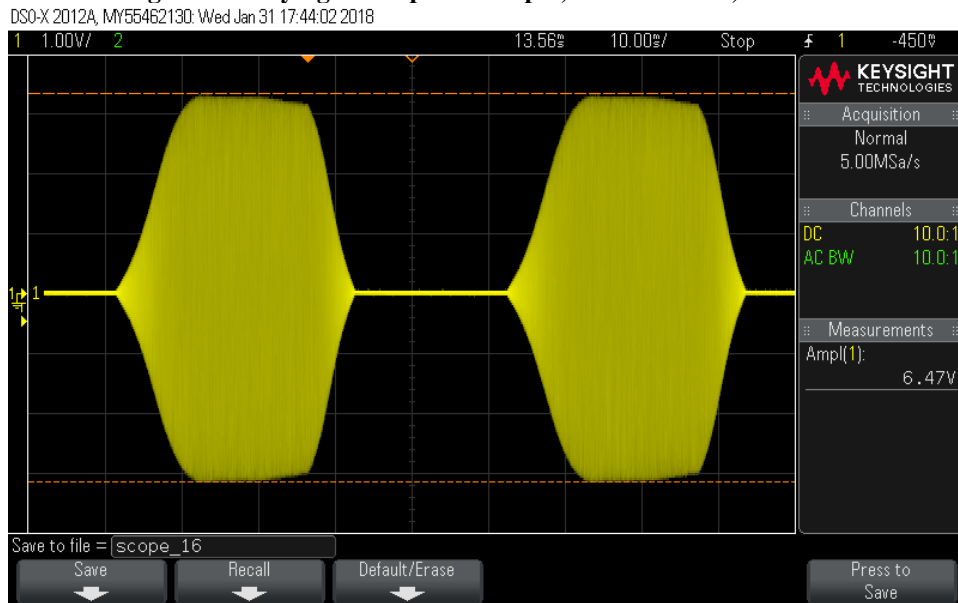

Figure 32: Keying envelope at 48 wpm, 8 ms rise time, 2 ms/div.



Note: In contrast to other HF transceivers tested, the IC-7610 exhibits a trapezoidal element shape at the highest keying speed (48 wpm), with some rounding at longer rise time settings. This appears to be a function of the ALC attack and decay time constants, and is less evident at lower keying speeds (e.g. Figure 33).

Reducing Drive Gain sufficiently to reduce RF power output will significantly alter the envelope shape.

It is desirable that the element amplitude be constant between the end of the rising flank and the beginning of the falling flank.

26a: CW "RF Tail" check. Channel 1 of the oscilloscope is terminated in 50Ω and connected to the IC-7610 RF output via a 50 dB high-power attenuator. Channel 2 is connected to the SEND RCA jack; a current source (in this case a DMM set to the diode test range) is bridged across the SEND line. A series of dits is transmitted from the internal keyer at the highest QSK keying speed (24 wpm) in break-in mode (F-BK).

The objective of this test is to ensure that the RF carrier ceases before the SEND line drops back to the standby state. This will prevent hot-switching of an external amplifier's T/R relays.

Test Conditions: 14.1MHz CW, 100W output to 50Ω load. CW rise time = 4 ms (default), TX DELAY (HF) = 10 ms. SEND Relay Type = MOS-FET.

Test Results: P_O reaches zero ≈ 9 ms *before* SEND line drops back to standby state (high). Thus, there is no undesirable "RF Tail". This time interval is independent of SEND Relay selection, CW rise time or TX Delay setting.

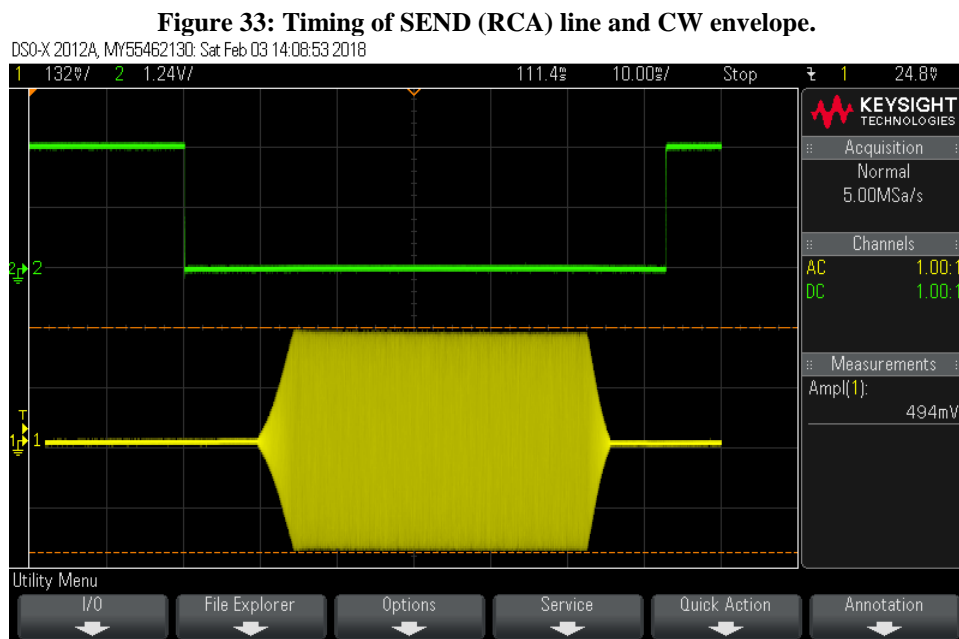

26b: CW QSK recovery test: This test was devised to measure the maximum speed at which the receiver can still be heard between code elements in QSK CW mode.

The IC-7610 is terminated in a 50Ω 100W load via a directional coupler. A test signal is injected into the signal path via the directional coupler; a 20 dB attenuator at the coupled port protects the signal generator from reverse power. Test signal level is adjusted for S3...S5 at the receiver. As the coupler is rated at 25W max., RF PWR is set at 10W.

Test Conditions: 14.100 kHz, 500 Hz CW, preamp off, ATT off, NR off, NB off, Fast AGC (0.1s), F-BK on, rise time = 4 ms, RF PWR at 10W, KEY SPEED at 48 wpm (max.), CW Pitch default. Test signal at 14099.8 kHz. Sidetone = 600 Hz, received tone = 800 Hz.

Starting at minimum KEY SPEED, transmit a continuous string of dits and increase KEY SPEED until the received tone can just no longer be heard in the spaces between dits.

Test Result: In the current test, the received tone could still be heard distinctly at **23-24 wpm**.

27: ACC1 Pin 4 (MOD, analog baseband input) and USB MOD level for 100W output.) A 1 kHz test tone is injected into ACC Pin 11, and the input voltage required for 100W RF output is noted. Next, the tone generator program in the laptop computer is set up to apply a 1 kHz test tone to the USB MOD input.

Test Conditions: 14100 kHz USB, DATA OFF MOD = ACC, DATA-1 MOD = ACC, ACC MOD Level = 50% (default), TBW = WIDE/MID/NAR (default values), Bass/Treble = 0 dB (default), COMP off, test tone 1 kHz.

Adjust test tone level for \approx 100W output in USB and USB-D1 modes. The required input levels were **20 mV RMS** for 100W output in USB, and **20 mV RMS** for 100W RF output (max. obtainable) in USB-D1.

Repeat test with DATA OFF MOD = USB, DATA-1 MOD = USB, initial USB MOD Level = 50% (default). 100W output was obtained with laptop tone generator level at 0 dB (nominal level) and USB MOD Level set at 20%.

27a: Carrier and opposite-sideband suppression. A 1 kHz test tone is applied to ACC Pin 1, and then via the USB port. Carrier and opposite-sideband suppression are checked on the spectrum analyzer at 100W RF output for both cases.

Test Conditions: 14100 kHz USB, DATA OFF MOD = ACC/USB, DATA-1 MOD = ACC/USB, TBW = WIDE (default), test tone 1 kHz.

Adjust test tone level for 100W output. Read carrier amplitude at 14100 kHz, and opposite-sideband amplitude at 14099 kHz.

Test Results: For ACC and USB test-tone input, carrier and opposite sideband both < -90 dBc (at or below the spectrum analyzer's noise floor). See Figure 34.

Figure 34: Carrier & opposite-sideband suppression at 14.1 MHz.

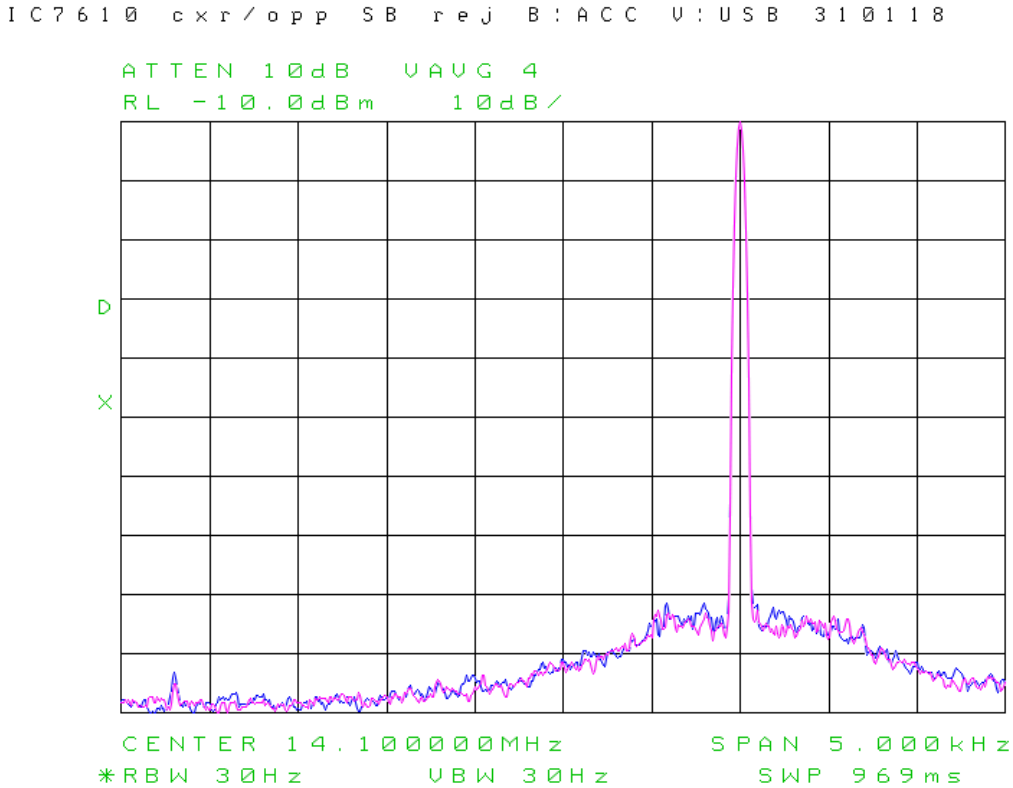

27b: SSB transmit audio-frequency response via USB port. In this test, a white-noise baseband is applied to the USB port from a tone-generator program running on a laptop computer. The spectrum analyzer is connected to the IC-7610 RF output via a 60 dB high-power attenuator.

Test Conditions: 14100 kHz USB, 100W PEP, DATA OFF MOD = USB, USB MOD Level = 50% (default). Test signal: white noise. WIDE, MID and NAR TBW are at default values.

On computer, adjust USB Audio Codec device volume for 50% ALC reading. Using Marker on spectrum analyzer, measure frequency and relative amplitude at lower passband edge. Move marker “down” 6 dB and record frequency. Move marker “down” a further 14 dB and record frequency again. Repeat procedure for upper passband edge. The test data are shown in Table 23.

Table 23: Measured SSB TX lower and upper cutoff frequencies (via USB input).

TBW	Lower (Hz)		Upper (Hz)	
	-20 dB	-6 dB	-6 dB	-20 dB
1 kHz = 0 dB ref.				
WIDE	55	75	2992	3083
MID	200	246	2796	2879
NAR	321	442	2600	2700

27c. AM transmit frequency response. Here, a white-noise baseband is applied to the USB port from a tone-generator program running on a laptop computer. The spectrum analyzer is connected to the IC-7610 RF output via a 60 dB high-power attenuator.

Test Conditions: 14100 kHz AM, 25W carrier, DATA OFF MOD = USB, USB MOD Level = 50% (default). Test signal: white noise. WIDE, MID and NAR TBW are at default values.

On computer, adjust USB Audio Codec device volume for 50% ALC reading.

Figure 35: AM with white noise modulation.

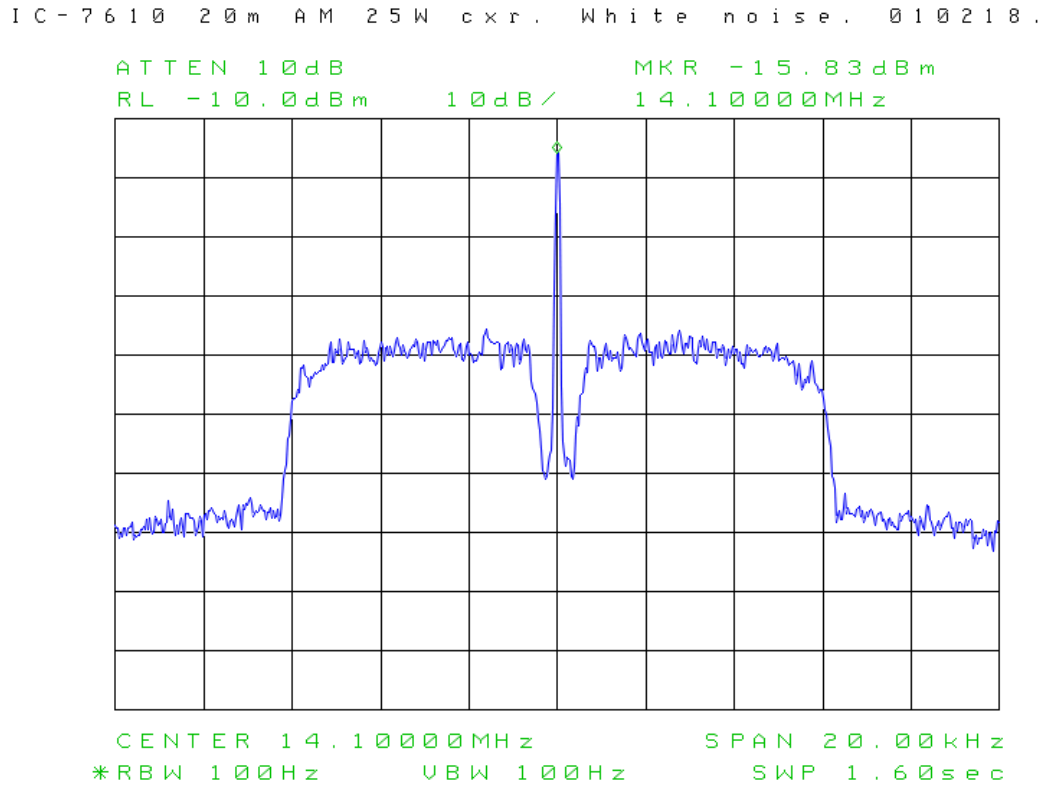

Note: Low-end cutoff frequency \approx 300 Hz at -6 dB. This roll-off ensures that artifacts from the DSP modulation process do not enter the carrier space and degrade the inserted carrier, causing distortion.

28: FM deviation. The IC-7610 output is connected to the RF IN/OUT port (75W max. input) of the communications test set. Voice and CTCSS peak deviation are checked.

Test Conditions: 29.6 and 52.525 MHz, FM, FIL1, RF PWR set at 25W. Speak loudly into mic and read deviation.

Test Result: Peak deviation = 4.4 kHz (both bands).

Next, select CTCSS TONE = 100 Hz (1Z). Set MIC Gain to 0%, key IC-7610 and read tone frequency and deviation on test set.

Test Result: Tone frequency 99.9 Hz, deviation 510 Hz.

28a: CTCSS decode sensitivity. The test set is configured as an RF generator. TSQL (CTCSS tone squelch) is enabled in the IC-7610 and the minimum RF input power and tone deviation at which the tone squelch opens are measured.

Test Conditions: 52.525 MHz, FM, FIL1, ATT off, CTCSS TSQL on, TONE 100 Hz (1Z). At test set, CTCSS tone deviation = 700 and 500 Hz.

Table 24: CTCSS Decode Sensitivity

Tone Dev. Hz	RF input level
700	-111
500	-111

28b: Residual FM. The communications test set is connected to the IC-7610 RF output via a 60 dB high-power attenuator. RF Power is adjusted to 100W CW output, and the residual FM deviation is read and recorded.

Test Conditions: 14100 kHz RTTY, 100W carrier output.

Test Result: Residual FM deviation \approx 30 Hz.

29: Transmit latency. In this test, a function generator feeds repetitive bursts of one cycle of a 1 kHz tone to the DUT line audio input (ACC1 Pin 4) and also to Channel 1 of a dual-trace oscilloscope. Channel 2 is connected via a high-power 50 dB attenuator to the DUT ANT socket. The scope is triggered from the function generator's SYNC output. The time interval between the leading edge of the AF burst displayed on Channel 1 and that of the RF burst displayed on Channel 2 is recorded for WIDE, MID and NAR TBW settings.

Test Conditions: 14100 kHz USB, 100W, DATA OFF MOD = ACC, ACC MOD Level = 50% (default). Test signal: tone burst. WIDE, MID and NAR TBW are at default values. Scope sweep 1 ms/div. See Figures 25 through 28.

Figure 36: Transmit latency, WIDE TBW. Latency 33.5 ms.

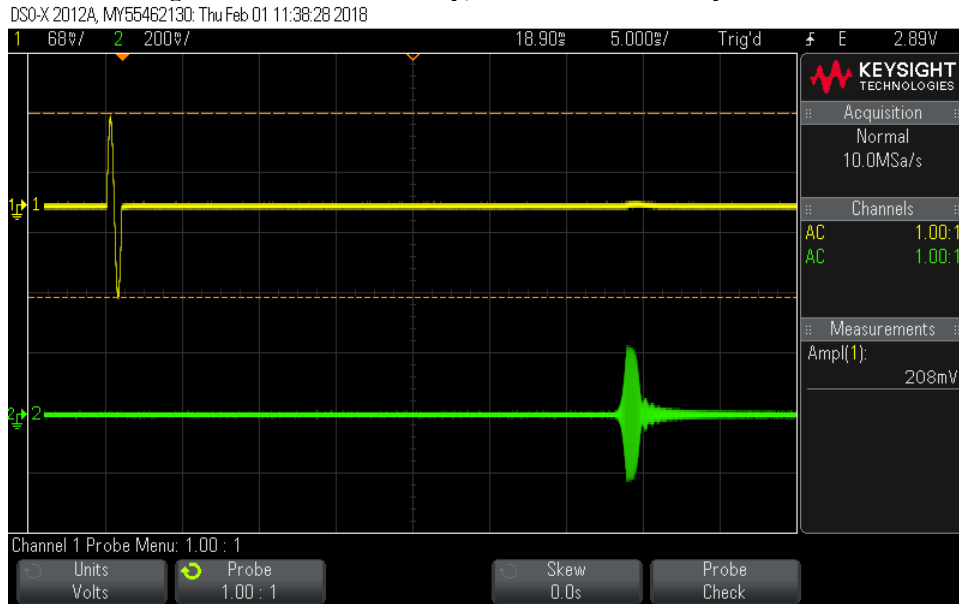

Figure 37: Transmit latency, MID TBW. Latency 34 ms.

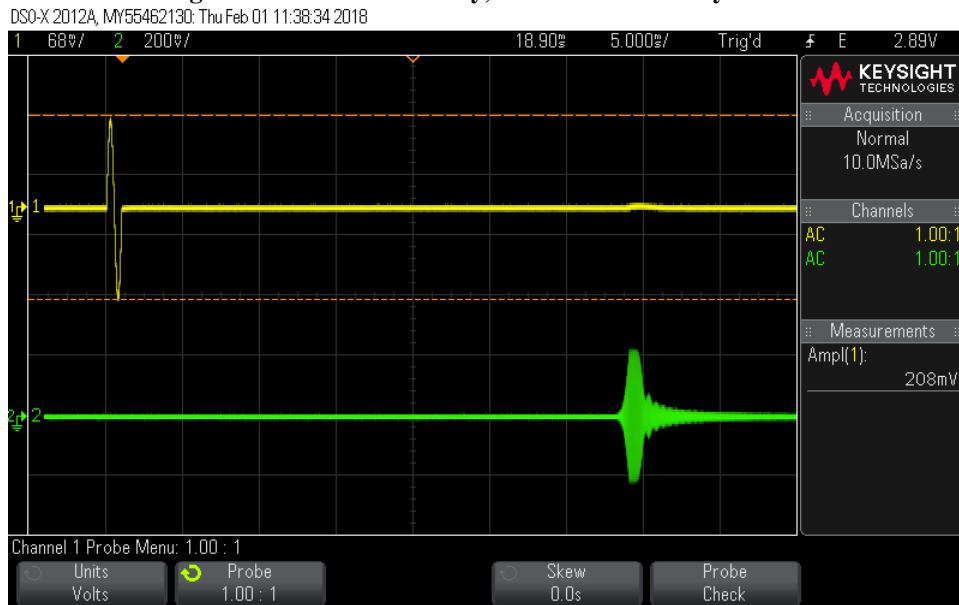

Figure 38: Transmit latency, NAR TBW. Latency 34.3 ms.

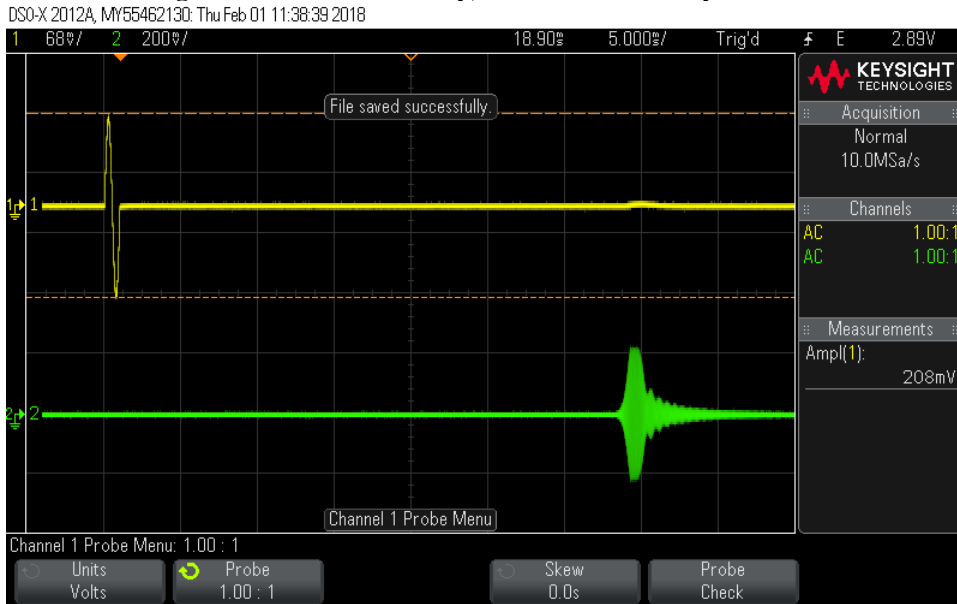
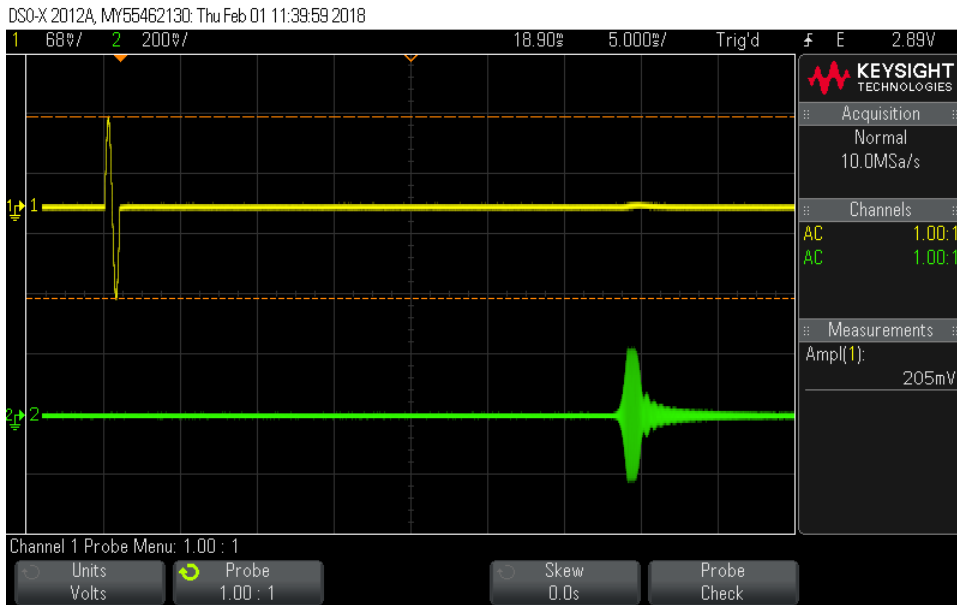

Figure 39: Transmit latency, USB-D1. Latency 34 ms.



30: RTTY (FSK, F1B) Transmitted Signal Test. The spectrum analyzer is connected to the IC-7610 ANT1 output via a 60 dB high-power attenuator. The -10 dBm reference level equates to 100W. An FSK (F1B) RYRYRY string is sent from internal TX MEM RT1.

Test Conditions: 14.1 MHz RTTY, 50W output to 50Ω load. Spectrum analyzer RBW/VBW as stated in Figures 38 and 39. Figure 40 shows the transmitter output ± 5 kHz from the carrier.

Next, the RYRYRY string is sent again and the occupied bandwidth measured using the OCC BW utility in the spectrum analyzer. Figure 41 shows the OCC BW test results. The theoretical occupied bandwidth (Occ BW) and necessary bandwidth (Nec BW) as defined in *Ref. 3* are calculated, and are also stated in Figure 41.

Figure 40.

IC-7610 F1B RY String 45.45Bd 20m 50W 130418

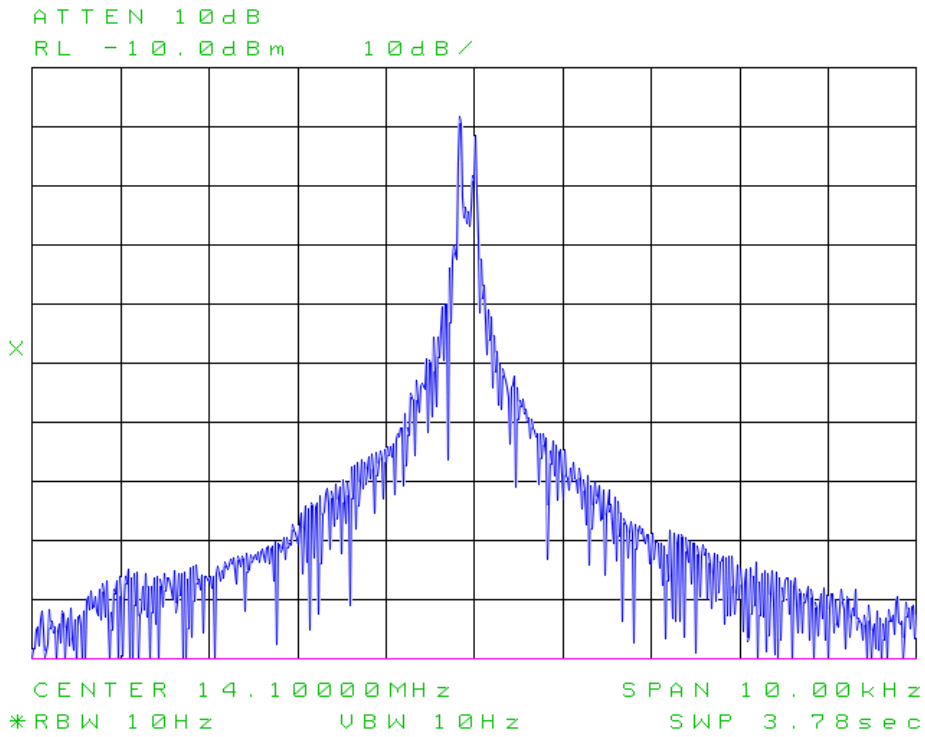
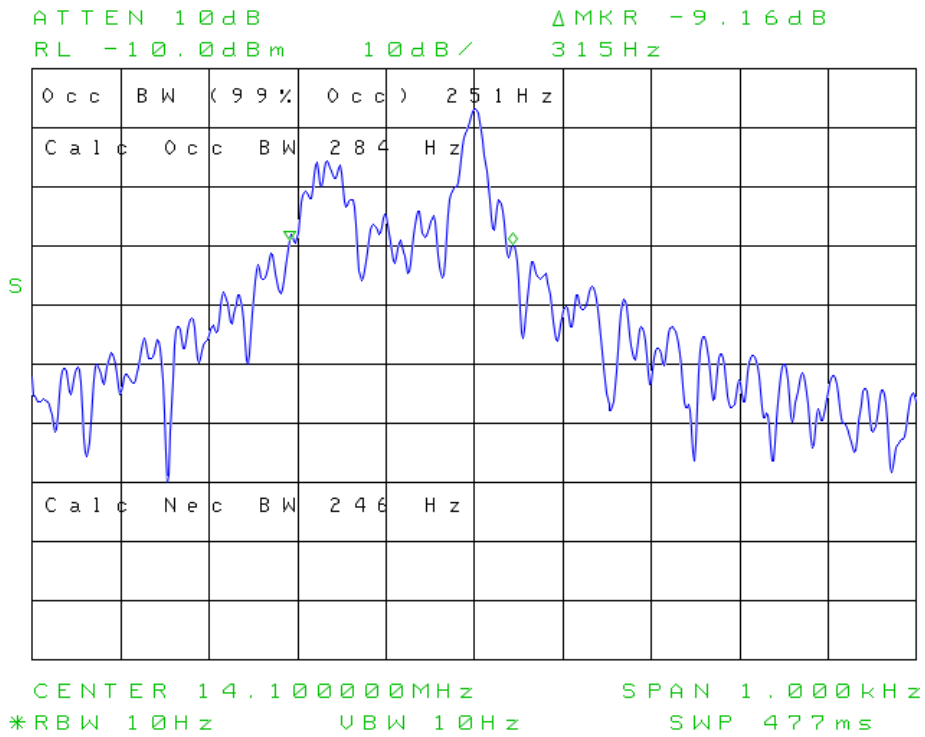

Figure 41.

IC-7610 F1B RY String 45.45Bd 20m 50W 130418



31a: Transverter Port Power Output. The transverter port is enabled via menu and the 50Ω probe of an RF millivoltmeter is connected to the X-VERTER port. In RTTY mode, transmitter is keyed and Po is increased in 10% steps from 0 to 100%, and the power output noted.

Test Conditions: Displayed frequency 44.100 MHz, offset 16 MHz (default), actual frequency 28.1 MHz, RTTY. Transverter Function ON. Po in range 0...100%. Test results: see Figure 42.

Figure 42: IC-7610 Transverter Port Power Output.

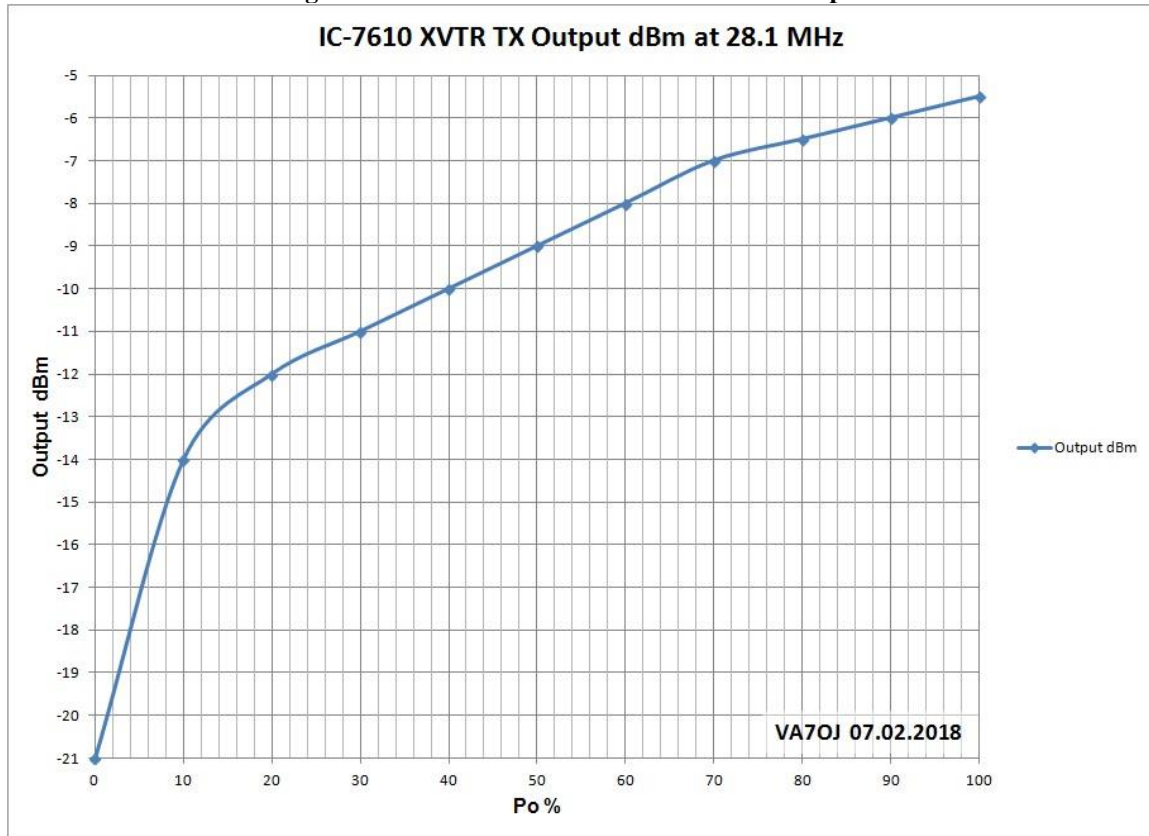

31b: Transverter Port Transmitted Phase Noise. Next, the Rohde & Schwarz FSUP 8 signal source analyzer is connected to the X-VERTER port. A phase noise sweep is run at Po = 100% on 28.1 MHz at 10 Hz – 1 MHz offset.

Test Conditions: 28.1 MHz RTTY. Input level to FSUP: -5 dBm. FSUP configured for AUTO level, 5 dB default attenuation, min. offset 10 Hz. Transverter function ON. Displayed frequency on DUT: 44.100 MHz, offset 16 MHz (default), actual frequency 28.1 MHz, RTTY. Transverter Function ON. Po = 100%. Figure 43 is the resulting phase-noise plot.

Figure 43: IC-7610 Transverter Port TX Phase Noise.



32: Firmware V1.11 SSB-D TBW Overshoot Test. Firmware V1.11 adds SSB-D to the Set/Tone Control menu item, now designated Tone Control/TBW. To accommodate the new digital modes, SSB-D TBW is now configurable in any combination of 100/200/300/500 Hz (lower flank) and 2500/2700/2800/2900 Hz (upper flank). An overshoot test was conducted to verify that this feature does not cause excess overshoot.

In this test, a timed 1 kHz tone burst was applied from the PC via the USB port, and the RF envelope observed on an oscilloscope terminated in 50Ω and connected to the IC-7610 RF output via a 50 dB high-power attenuator.

Test Conditions: 14100 kHz USB, USB-D1, TBW = 100-2900 Hz, MOD = USB, USB MOD Level = 50% (default). Test signal: 1 kHz tone burst, 200 ms duration. Set $P_o = 100W$ in RTTY mode. Select USB-D, then adjust USB Audio Codec device volume on computer for 50% ALC reading with continuous test tone. Switch to tone burst and capture screenshot with oscilloscope in single-shot mode. Repeat test at $P_o = 50W$ and $20W$.

Test Results: See Figure 44 (example) and Table 25. Only one small initial overshoot event was observed. See Table 21. These results are substantially the same as reported for SSB voice (Table 21, p. 26.),

Table 25: Initial SSB overshoot.

PEP output W	Overshoot dB
100	≈ 0.6
50	≈ 0.8
20	≈ 1.1

Figure 44. USB-D Initial Overshoot, 100W PEP

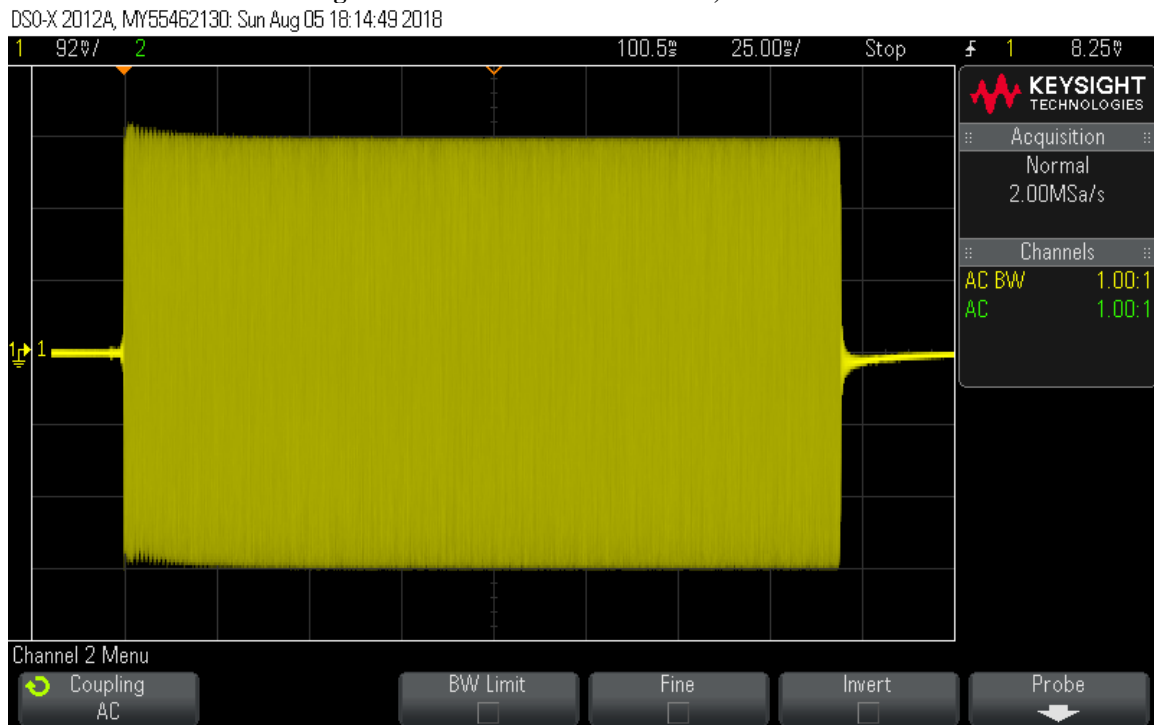

33: References.

1. HF Receiver Testing: Issues & Advances”:
<https://www.ab4oj.com/test/docs/rcvrtest.pdf>
2. “Noise Power Ratio (NPR) Testing of HF Receivers”:
https://www.ab4oj.com/test/docs/npr_test.pdf
3. ITU-R Rec. SM.328-11, Annex 1, Sections 1.1 and 1.7.

Copyright © 2018 A. Farson VA7OJ/AB4OJ. All rights reserved.
Jan. 22 - Aug. 5, 2018 & Nov. 26, 2020.