



IC-EX310

VOICE SYNTHESIZER UNIT

INSTRUCTION MANUAL

This instruction manual gives descriptions and installation instructions for the optional voice synthesizer unit for ICOM transceivers IC-751, IC-271A/E and IC-471A/E. It also provides information you need while using them. Please read all the instructions carefully before installation so you will get maximum performance and full value from each set.

PREPARATION

Before performing any work on the set, make sure that the power cord is unplugged from the transceiver. Remove the top and bottom covers by unscrewing the six screws each on the top and bottom, and the three screws on each side, while taking care not to damage the internal speaker, and unplug its connector.

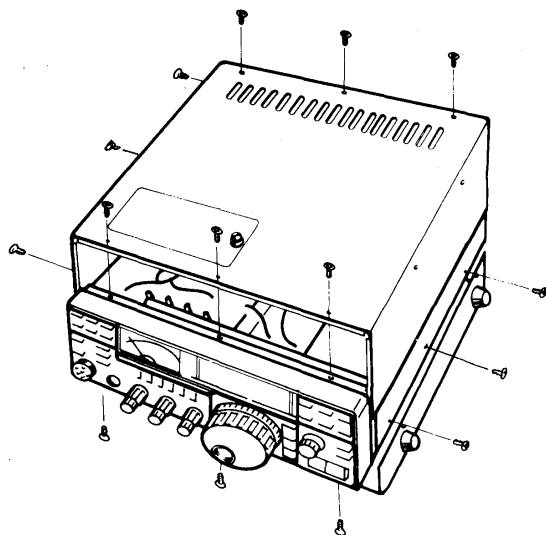

ASSEMBLY PROCEDURE

FOR IC-751

1. Turn the transceiver upside down.

2. Insert 2-P plug as shown in the photo into J2 of this unit, then install the unit with the supplied four screws as shown in the photo.

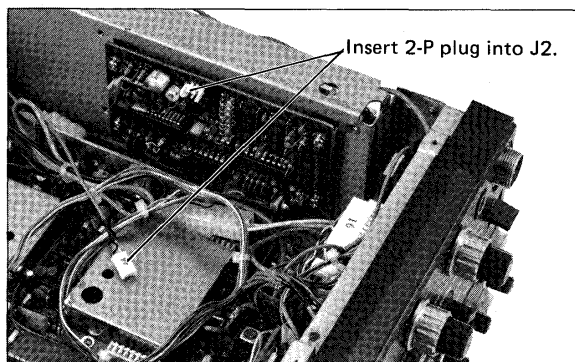

3. Plug 8-P plug of this unit into J12 of the LOGIC unit.

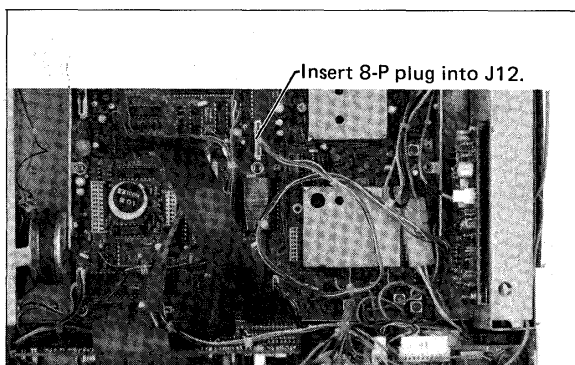

4. Adjust its volume and speaking speed if necessary. (Described later.)
5. Connect internal speaker connector, then replace the top and bottom covers of the set.

FOR IC-271A/E AND IC-471A/E

1. Insert 2-P plug as shown in the photo into J2 of this unit, then install the unit with the supplied four screws as shown in the photo.

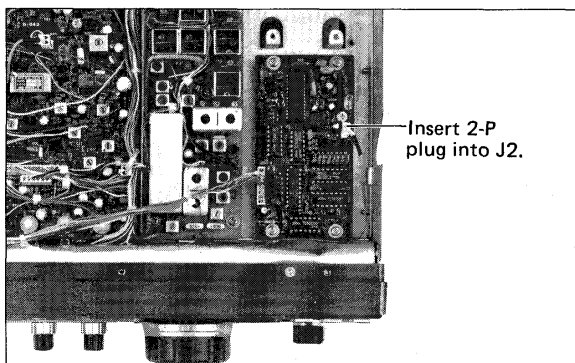

- Run the cord with 8-P connector from the unit along the front panel, then pass it through the slot between the front panel and chassis located around the meter hood, to the bottom side.

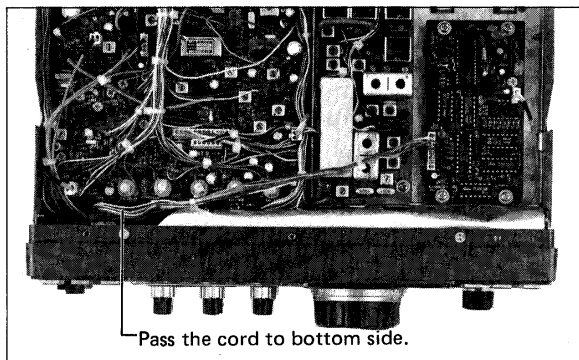

- Turn the set upside down. Then insert the 8-P connector into J10 of the LOGIC unit.

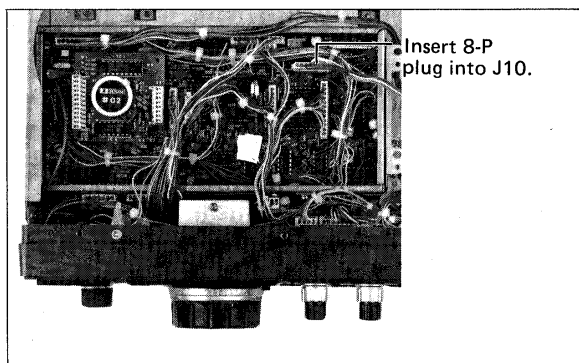

- Adjust its volume and speaking speed if necessary. (Described later.)
- Connect internal speaker connector, then replace the top and bottom covers of the set.

ADJUSTMENT

- Adjust the volume of the speech and speaking speed before the top and bottom covers are replaced, if necessary.
- Connect a power source and turn on the power switch.
- By pushing the SPEECH switch (IC-271A/E and IC-471A/E: the DIAL LOCK AND SPEECH switch), the unit is actuated and announces the displayed frequency in English.

- The volume of the announcement is adjustable with R16 in the unit. Adjust it for a comfortable level.
- By cutting W1 jumper wire, the speaking speed becomes faster.

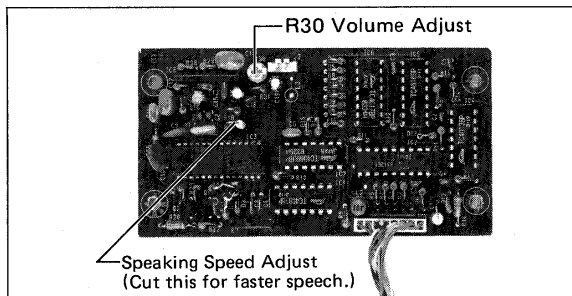

- When finished with the adjustment, replace the top and bottom covers of the set.

HOW THE VOICE SYNTHESIZER UNIT WORKS

- When "14.231.5MHZ" is displayed; "ONE FOUR POINT TWO THREE ONE FIVE MHZ" will be heard.
- When "145.280.0MHZ" is displayed; "ONE FOUR FIVE POINT TWO EIGHT ZERO ZERO MHZ" will be heard.
- When a blanked memory channel is selected; "POINT MHZ" will be heard.
- When the TONE SELECT button is pushed and TONE NUMBER "16" is displayed (IC-271A/E only); "POINT ONE SIX MHZ" will be heard.
- When the OFFSET WRITE button is pushed and offset frequency "05.000." is displayed; "ZERO FIVE POINT ZERO ZERO ZERO MHZ" will be heard.

ICOM INCORPORATED

1-6-19, KAMIKURATSUKURI HIRANO-KU,
OSAKA JAPAN