

## SECTION 1 FEATURES

### ■ COMPLETE HF RADIO

- ALL BAND, ALL MODE  
ALL SOLID-STATE

The IC-751A covers all Amateur HF frequencies from 1.8MHz to 30MHz, including the three new bands of 10MHz, 18MHz and 24MHz. It also offers SSB, CW, AM, FM and RTTY operating modes as standard features. All circuits in the IC-751A, including the driver and final power stages, are completely solid-state producing a final output power of 100 watts.

- GENERAL COVERAGE RECEIVER

The IC-751A features general coverage receive capability with a tuning range from 100kHz to 30MHz. This wide range is accomplished by means of up-conversion using a high side IF and a CPU control system.

- FULL BREAK-IN FUNCTION

For CW operators, both semi break-in and full break-in are provided for smooth, fast and natural CW conversations.

### ■ OUTSTANDING RECEIVER PERFORMANCE

- ICOM'S DFM SYSTEM

The ICOM DFM (Direct Feed Mixer) feeds the incoming signals directly into a high level first mixer developed by ICOM. This advanced system produces a higher spurious response rejection ratio, a higher receiver sensitivity and a wider dynamic range.

- 105dB DYNAMIC RANGE

The IC-751A has a 105dB dynamic range. Even with the PREAMP switched ON, the dynamic range is approximately 100dB.

- PREAMP AND ATTENUATOR  
INCLUDED

Both a 10dB preamplifier PLUS a 20dB attenuator are installed as standard equipment. The preamplifier increases receiver sensitivity while the attenuator provides added protection from intermodulation problems.

### ■ NEWLY DEVELOPED CPU

- VARIOUS SCANNING FUNCTIONS

Memory Scan allows monitoring of all memory channels or only those storing a particular mode. Programmed Scan provides scanning between any two programmed frequencies. Mode Scan automatically monitors only memories containing frequencies with a similar mode. In all cases, the Auto-stop function halts the scan when a signal is received and the Resume function restarts the scan when the frequency is clear.

- 32 MEMORIES

Thirty-two programmable memories are provided to store mode and frequency, and the CPU is backed up by an internal lithium battery to maintain the memories for up to ten years. Scanning of frequencies or memories is possible from either the transceiver or the HM-36 scanning microphone.

### ■ OPTIONS AVAILABLE

- IC-PS30

The IC-PS30 external AC power supply was developed especially for ICOM base radios and matches the style and size of the IC-751A. This power supply uses a recently designed switching regulator, resulting in light weight and high efficiency.

- IC-2KL

The IC-2KL is a completely solid-state, HF broadband linear amplifier with 500 watts output to give your signal the extra boost needed for solid contacts when propagation is poor.

## SECTION 2 SPECIFICATIONS

### 2 - 1 GENERAL

Frequency coverage	: Ham Bands 1.8MHz ~ 2.0MHz 3.45MHz ~ 4.1MHz 6.95MHz ~ 7.5MHz 9.95MHz ~ 10.5MHz 13.95MHz ~ 14.5MHz 17.95MHz ~ 18.5MHz 20.95MHz ~ 21.5MHz 24.45MHz ~ 25.1MHz 27.95MHz ~ 30.0MHz General Coverage (Receive Only) 0.1MHz ~ 30.0MHz
Usable temperature range	: $-10^{\circ}\text{C} \sim +60^{\circ}\text{C}$ ( $+14^{\circ}\text{F} \sim +140^{\circ}\text{F}$ )
Frequency control	: CPU based 10Hz step digital PLL synthesizer. Independent transmit/receive frequency.
Frequency readout	: 6 digit 100Hz illuminated FIP.
Frequency stability	: Less than $\pm 200\text{Hz}$ from 1 to 60 minutes after power ON. Less than $\pm 30\text{Hz}$ after 1 hour at $25^{\circ}\text{C}$ . Less than $\pm 350\text{Hz}$ in the range of $0^{\circ}\text{C} + 50^{\circ}\text{C}$ .
Power supply requirements	: 13.8V DC $\pm 15\%$ (negative ground), current drain 20A maximum at 200W input. AC power supply is available for AC operation.
Current drain (at 13.8V DC)	: Transmitting At 200 watts input                      Approx.      20.0A Receiving At maximum audio output      Approx.      1.8A Squelched                                  Approx.      1.5A
Antenna impedance	: 50 ohms unbalanced.
Weight	: 8.5kg
Dimensions	: 306(322)mm(W) x 115(120)mm(H) x 355(385)mm(D) Bracketed values include projections.

### 2 - 2 TRANSMITTER

RF power	: SSB (J3E) : 200 watts PEP input CW (A1A) : 200 watts input FM (F3E) : 200 watts input RTTY (F1A) : 200 watts input AM (A3E) : 50 watts output
Emission modes	: SSB (J3E) Upper and Lower sideband CW (A1A) FM (F3E) RTTY (F1A) AM (A3E)
Harmonic emissions	: More than 40dB below peak power output.
Spurious emissions	: More than 60dB below peak power output. (Guaranteed for transmissions within the Amateur bands.)
Carrier suppression	: More than 40dB below peak power output.
Unwanted sideband	: More than 55dB down with 1000Hz AF input.
Microphone	: Impedance 600 ohms Input level 12 millivolts typical Dynamic or electret condenser
$\Delta$ TX variable range	: $\pm 9.99\text{kHz}$

## 2 - 3 RECEIVER

Receive system	: SSB, CW, RTTY, AM Quadruple-conversion superheterodyne with continuous bandwidth control.
	FM Triple-conversion superheterodyne.
Receive modes	: SSB (J3E) Upper and Lower sideband CW (A1A) FM (F3E) RTTY (F1A) AM (A3E)
Intermediate frequencies	: 1st: All modes 70.4515MHz 2nd: SSB 9.0115MHz CW, RTTY 9.0106MHz FM, AM 9.0100MHz 3rd: All modes 455kHz 4th: SSB 9.0115MHz CW, RTTY 9.0106MHz AM 9.0100MHz
Sensitivity (PREAMP ON)	: SSB, CW, RTTY 0.1 ~ 0.5MHz Less than 0.5 $\mu$ V for 10dB S/N 0.5 ~ 1.6MHz Less than 1 $\mu$ V for 10dB S/N 1.6 ~ 30.0MHz Less than 0.15 $\mu$ V for 10dB S/N AM (NARROW FILTER selected) 0.1 ~ 0.5MHz Less than 3 $\mu$ V for 10dB S/N 0.5 ~ 1.6MHz Less than 6 $\mu$ V for 10dB S/N 1.6 ~ 30.0MHz Less than 1 $\mu$ V for 10dB S/N FM 28 ~ 30MHz Less than 0.3 $\mu$ V for 12dB SINAD
Squelch sensitivity	: 1.6 ~ 30MHz Less than 0.3 $\mu$ V
Selectivity	: SSB, CW, RTTY (WIDE FILTER selected), AM (NARROW) 2.3kHz at -6dB points 3.8kHz at -60dB points CW, RTTY 500Hz at -6dB points 1.3kHz at -60dB points FM 15kHz at -6dB points 30kHz at -50dB points AM (WIDE FILTER selected) 8kHz at -6dB points 18kHz at -50dB points
Spurious and image response rejection	: Image rejection More than 80dB IF rejection More than 70dB
Audio output	: More than 2.6 watts at 10% distortion with 8 ohm load.
Notch filter attenuation	: More than 45dB
RIT variable range	: $\pm$ 9.99kHz

All stated specifications are subject to change without notice or obligation.

# SECTION 3 CONTROL FUNCTIONS

## 3-1 FRONT PANEL

See SECTION 3 - 2 for frequency display.

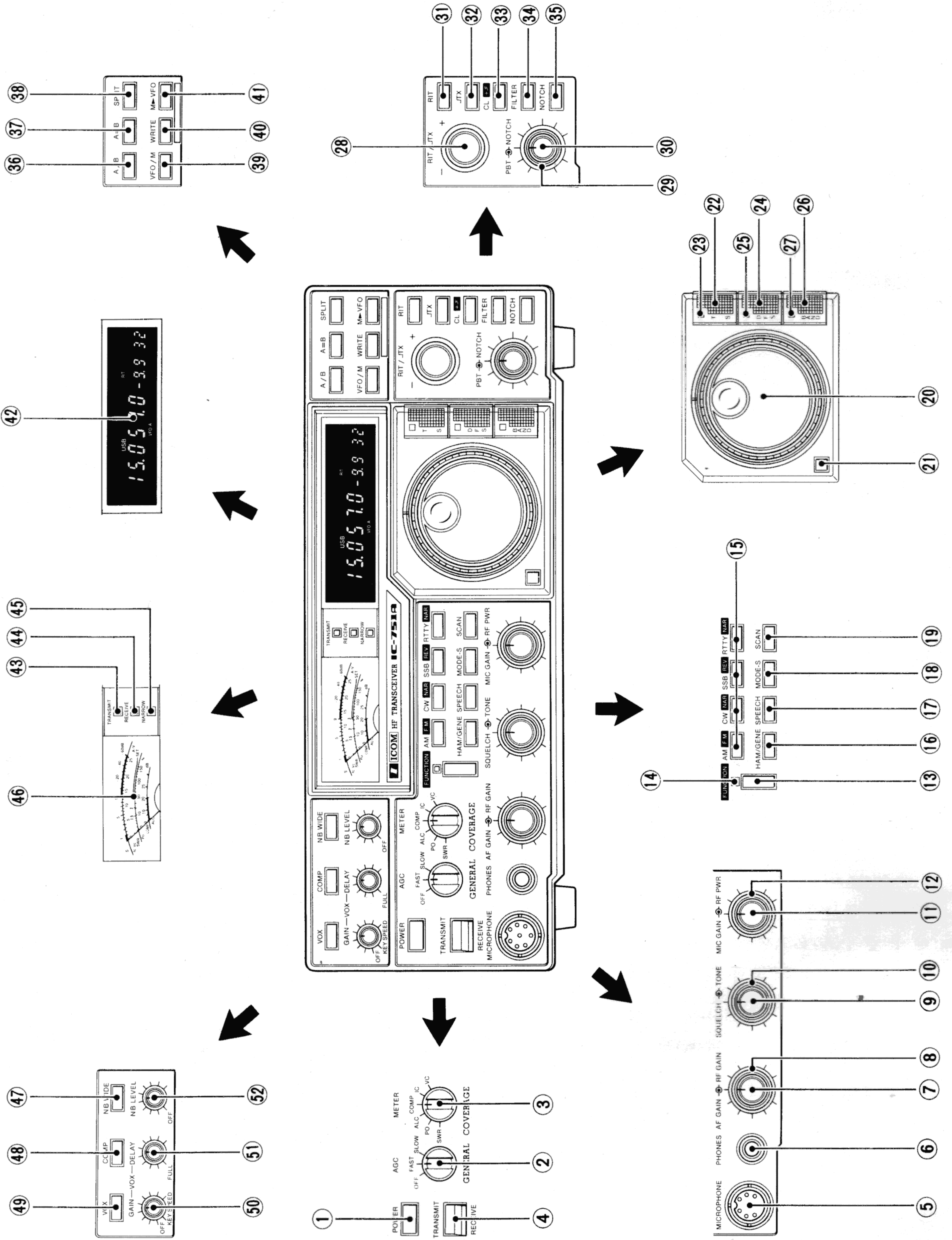

① POWER SWITCH



This is a push-lock switch which controls the input DC power to the IC-751A. When the IC-PS30 AC power supply is used, the switch also acts as the AC power supply switch. Power is supplied to the transceiver when the switch is pushed IN and locked. Power to all circuits is cut (except to the PA unit when using a DC power supply) when the switch is pushed again and released.

② AUTOMATIC GAIN CONTROL SWITCH [AGC]

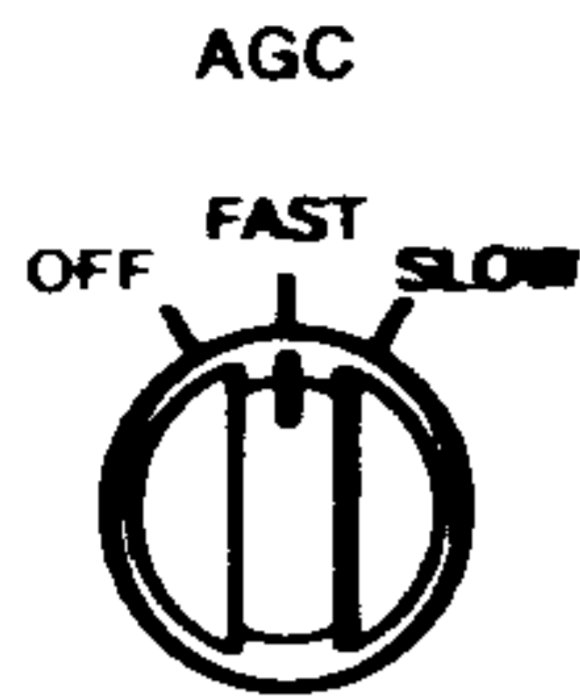

This switch changes the time constant of the AGC circuit. In the **SLOW** position, the AGC voltage releases slowly for SSB reception. In the **FAST** position, the AGC voltage releases quickly suitable for receiving CW signals or signals with rapid fading.

In the **OFF** position, the AGC circuit and S-meter are disabled. Also, the AGC circuit does not actuate in the FM mode.

③ METER SWITCH

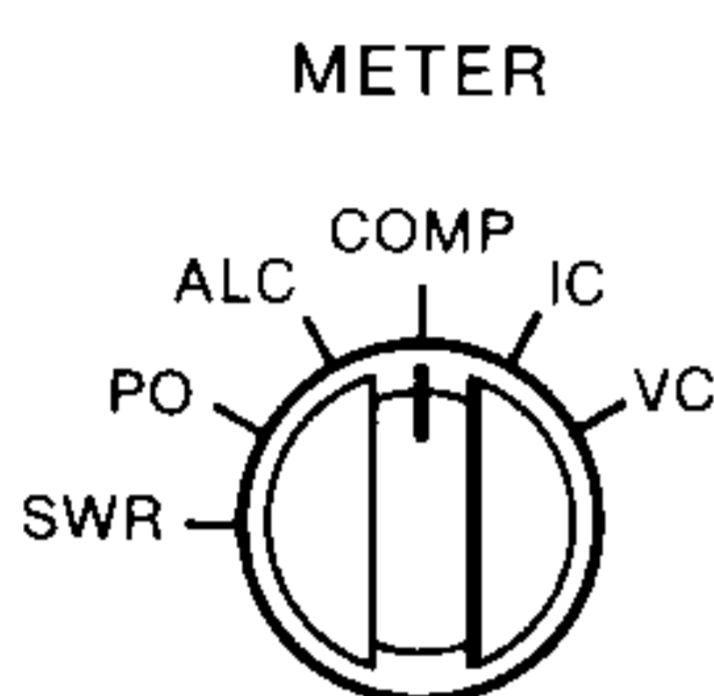

In the transmit mode, the front panel meter has six functions.

Vc	Indicates the collector voltage of the final transistors.
Ic	Indicates the collector current of the final transistors.
COMP	Indicates the compression level when the speech compressor is in use.
ALC	Indicates the ALC level. The ALC circuit begins to function when the RF output power reaches a preset level.
Po	Indicates the approximate output power.
SWR	Indicates the SWR of the antenna system after the meter is referenced at "SET" while the Po meter function is selected.

④ TRANSMIT/RECEIVE (T/R) SWITCH

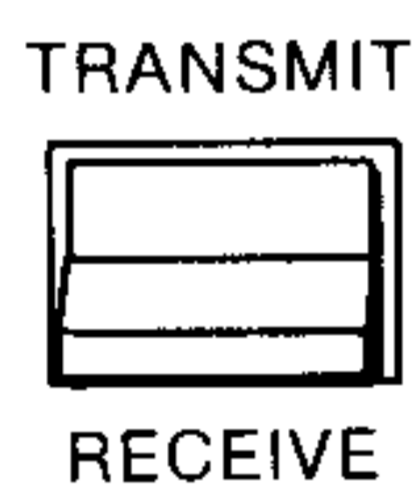

This switch is for manually changing between transmit and receive. Set the switch to **RECEIVE** (down) to place the IC-751A in the receive mode. Move the switch to **TRANSMIT** (up) to change to the transmit mode. When using the PTT SWITCH on the microphone or VOX operation, the T/R SWITCH must be at **RECEIVE**.

⑤ MIC CONNECTOR

Connect a suitable microphone to this connector. The supplied HM-36 hand microphone or the optional SM-10 desk microphone may be used. When using other microphones, refer to the diagram in SECTION 4 - 4.

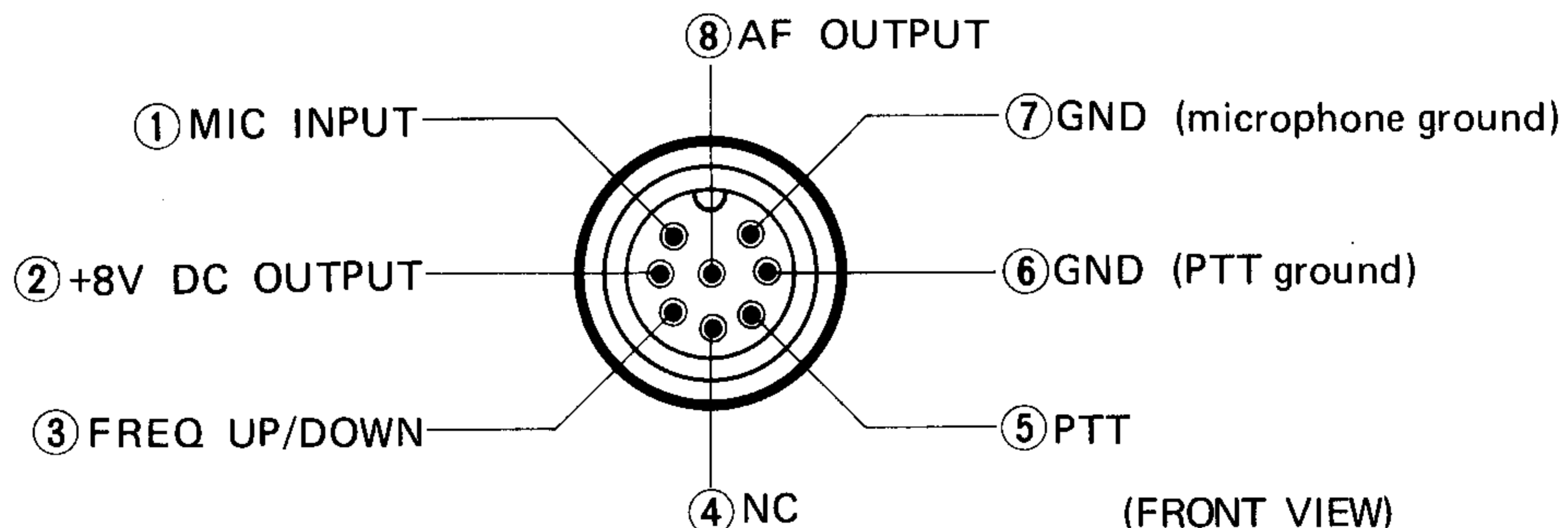

⑥ PHONES JACK

This jack accepts a standard 1/4 inch plug from headphones with an impedance of 4 ~ 16 ohms. Stereo headphones may be used without modification.

⑦ AF GAIN CONTROL

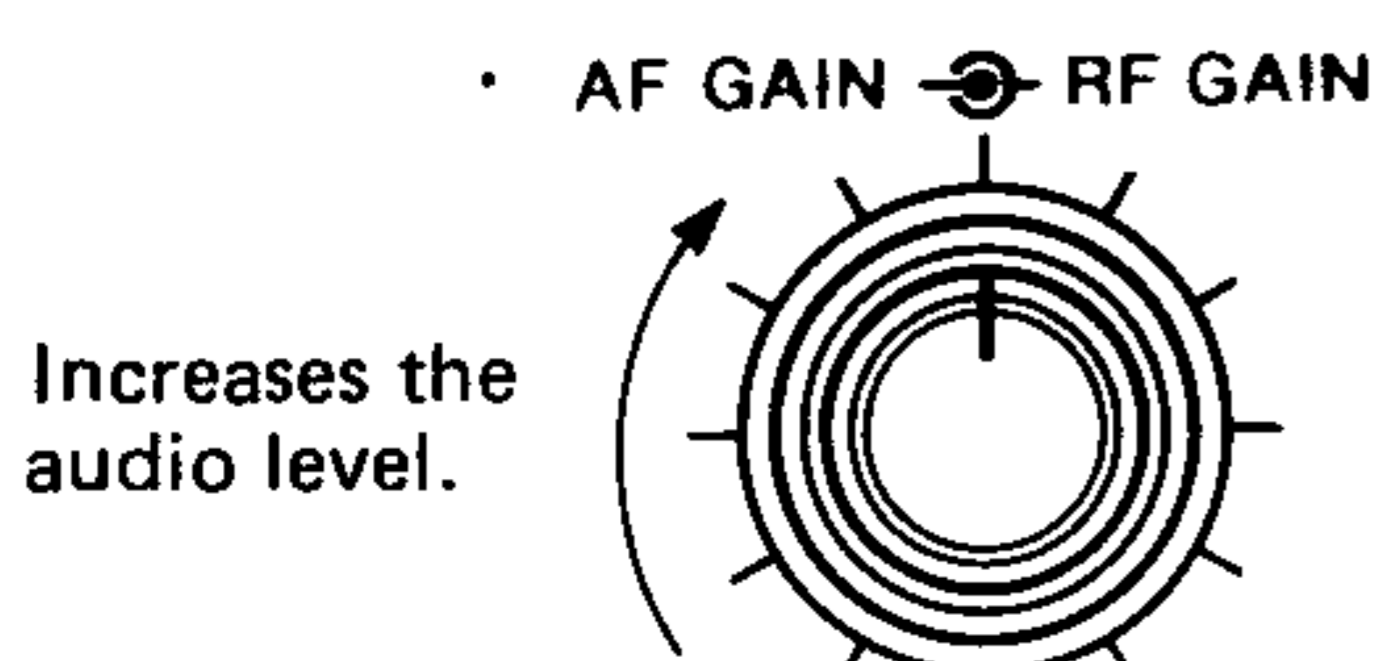

This control varies the audio output level in the receive mode. Clockwise rotation increases the level.

**⑧ RF GAIN CONTROL**

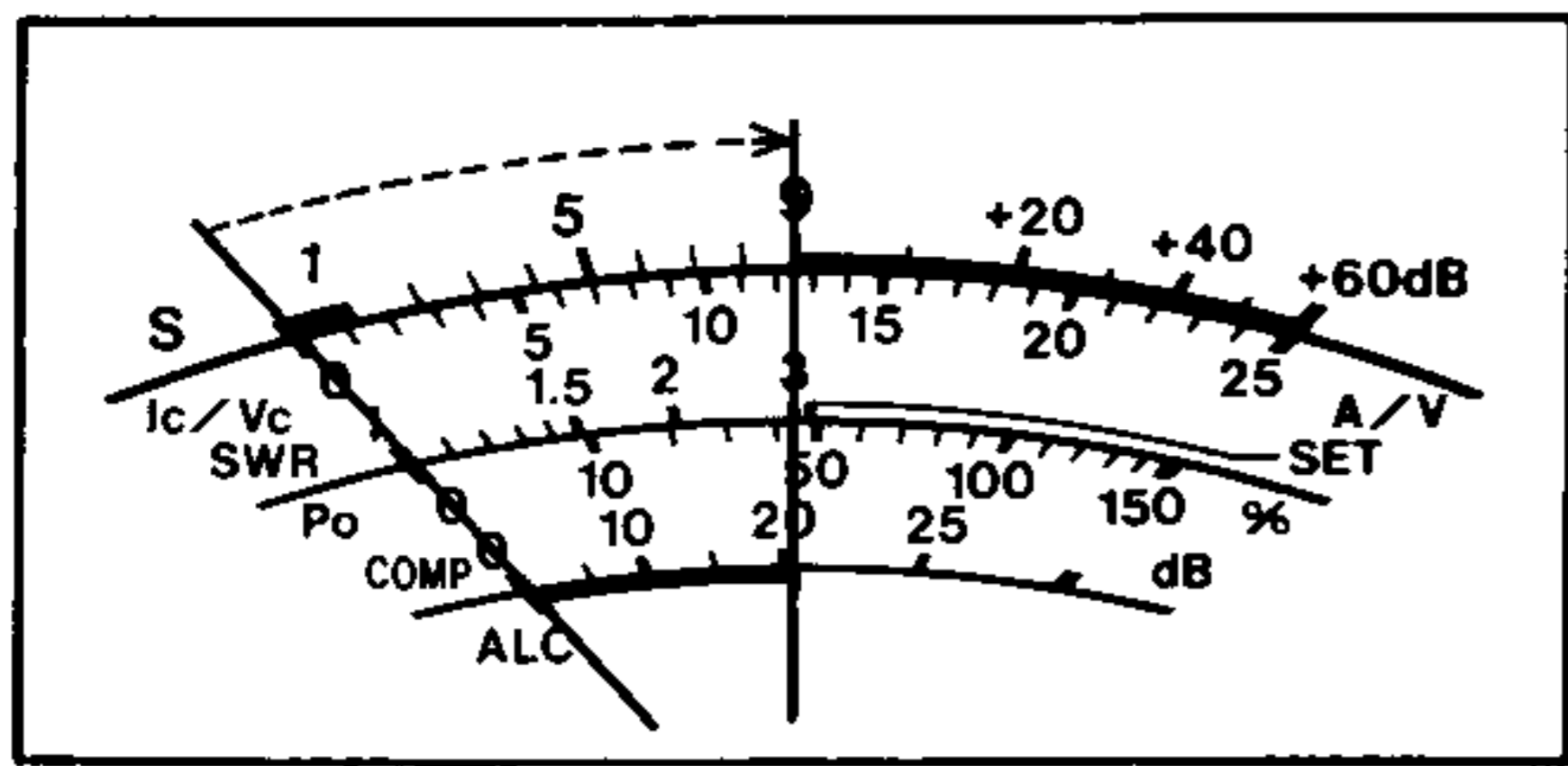

This control varies the gain of the RF stage when the transceiver is in the receive mode. Rotate the control fully clockwise for maximum gain. When tuning in the SSB or CW mode, the S-meter needle rises as the control is rotated counterclockwise and only those signals stronger than the level indicated by the needle are heard.

**⑨ SQUELCH CONTROL**

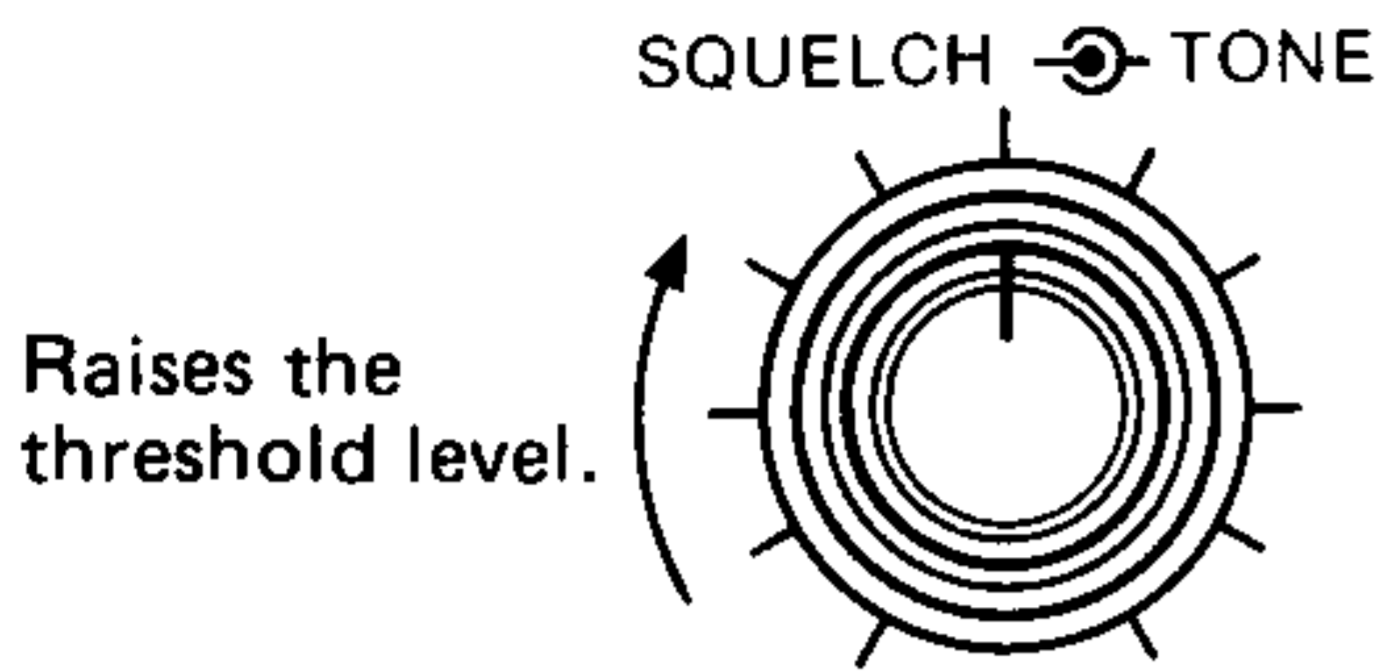

This control sets the squelch threshold level. To turn OFF the squelch function, rotate this control completely counterclockwise. To set the threshold level higher, rotate the control clockwise.

Adjust this control clockwise until the green RECEIVE indicator just goes out while no signal is being received.

**⑩ TONE CONTROL**

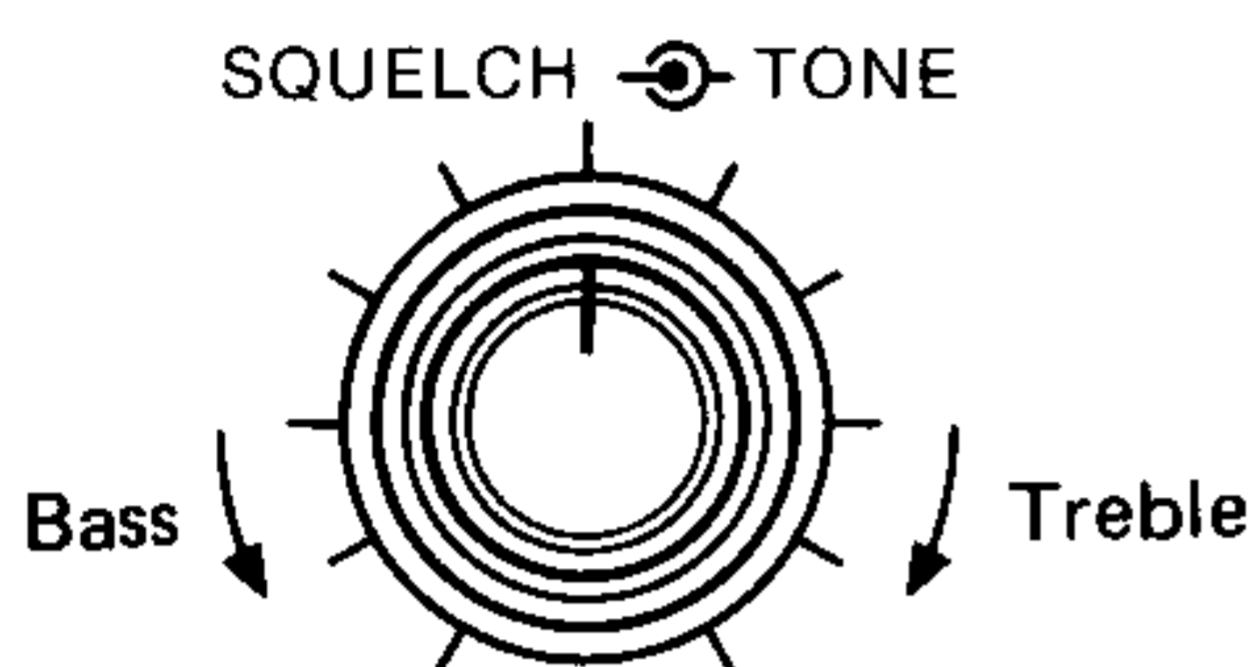

This control varies the receive audio tone. Adjust the control to provide the clearest, most pleasing audio.

**⑪ MIC GAIN CONTROL**

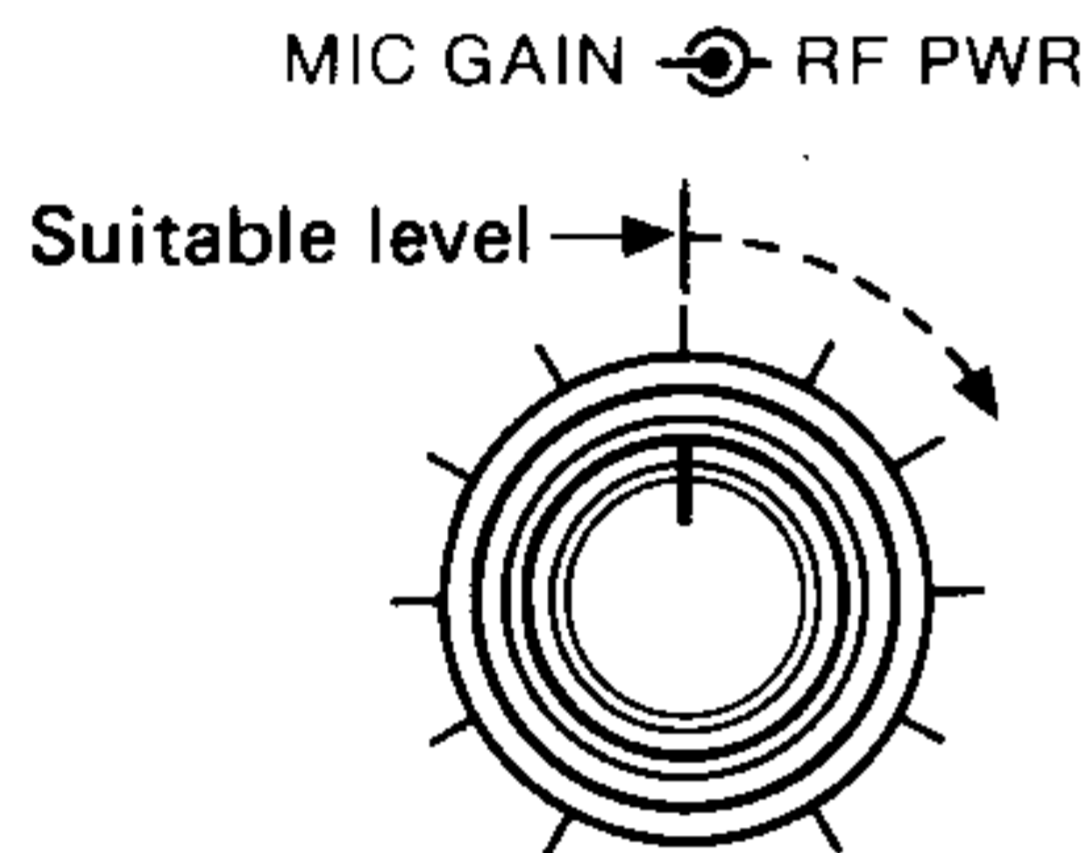

Adjust this control for a suitable modulation level while speaking into the microphone in a normal voice. Rotate the control clockwise to increase the gain.

**⑫ RF POWER CONTROL**

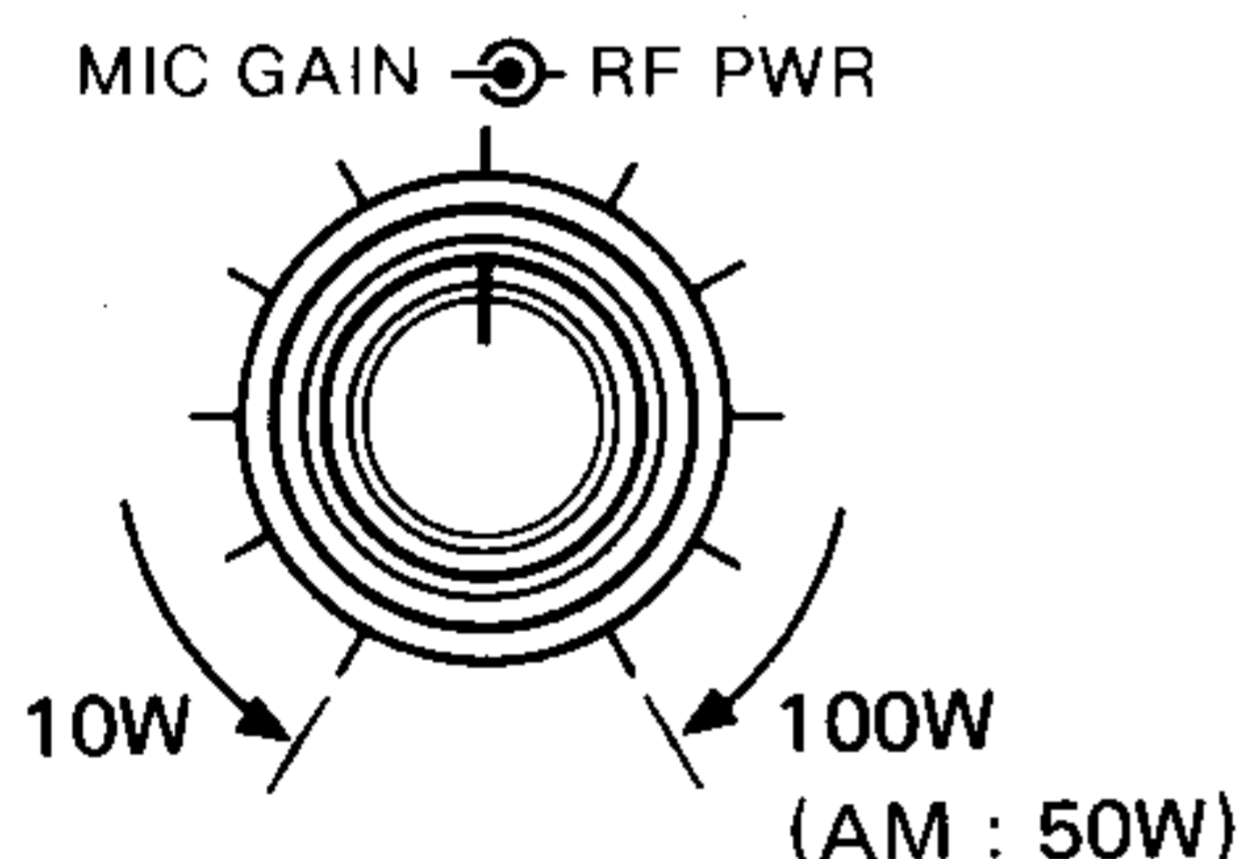

This control varies the RF output power from 10 watts to maximum.

- SSB : 100W PEP
- CW, RTTY, FM : 100W
- AM : 50W

Rotate the control clockwise to increase the output power. Use the minimum power necessary for reliable communication.

**⑬ FUNCTION SWITCH**

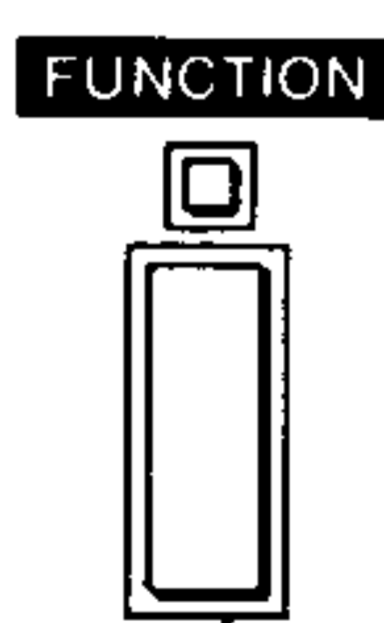

This switch activates the secondary switch functions on the front panel as indicated by the reverse-image lettering (white letters on a black background).

**⑭ FUNCTION INDICATOR**

The FUNCTION INDICATOR lights after the FUNCTION SWITCH is pushed, and indicates that the secondary switch functions are activated.

**⑮ MODE SWITCHES**



**AM:**  
Push for AM operation.

**FM:**  
Push the FUNCTION SWITCH first, then push the AM SWITCH to select the FM mode.

**CW:**  
Push for CW operation with the standard filters.

**CW NARROW (NAR):**

Push the **FUNCTION SWITCH** first, then push the **CW SWITCH** for operation with the 455kHz narrow CW filter. There is no audio output from the speaker if the optional filter is not installed.

**SSB:**

Push to automatically select upper sideband (USB) operation on the 10MHz band and above, and lower sideband (LSB) operation on the 7MHz band and below. In the **GENERAL COVERAGE** mode, USB is selected from 9MHz upwards, and LSB is selected below 9MHz.

**SSB REVERSE:**

Push the **FUNCTION SWITCH** first, then push the **SSB SWITCH** to select LSB on the 10MHz band and above, and USB on the 7MHz band and below. In the **GENERAL COVERAGE** mode, LSB is selected from 9MHz upwards, and USB is selected below 9MHz.

**RTTY:**

Push for RTTY operation.

**RTTY NARROW (NAR):**

Push the **FUNCTION SWITCH** first, then push the **RTTY SWITCH** for RTTY operation using the optional 455kHz narrow CW filter. There is no audio output from the speaker if the optional filter is not installed.

**⑩ HAM BAND/GENERAL COVERAGE SWITCH [HAM/GENE]**

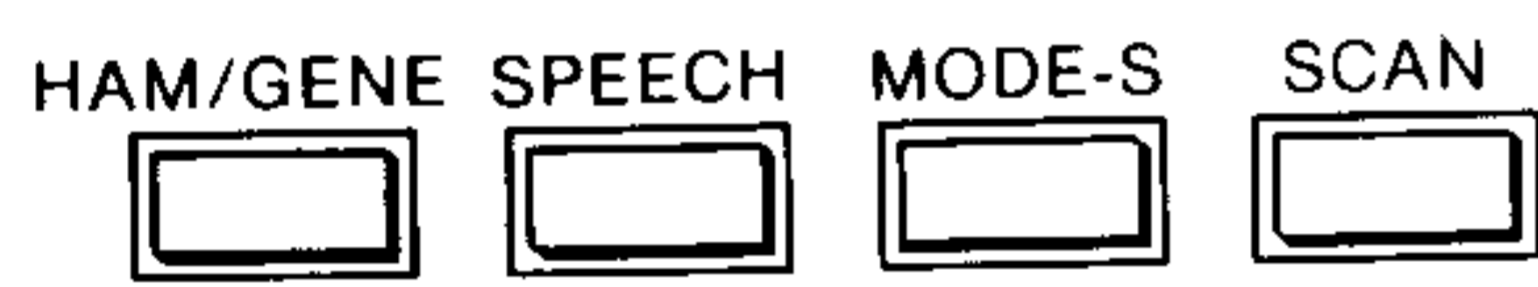

This switch changes the IC-751A between the Amateur Band and General Coverage modes. In the Amateur Band mode, the transceiver functions on any of the HF amateur bands from 1.8 to 28MHz. In the General Coverage mode, the receiver functions on all frequencies from 0.1 to 30MHz. The IC-751A does not transmit while in the General Coverage mode.

**⑪ SPEECH SWITCH**

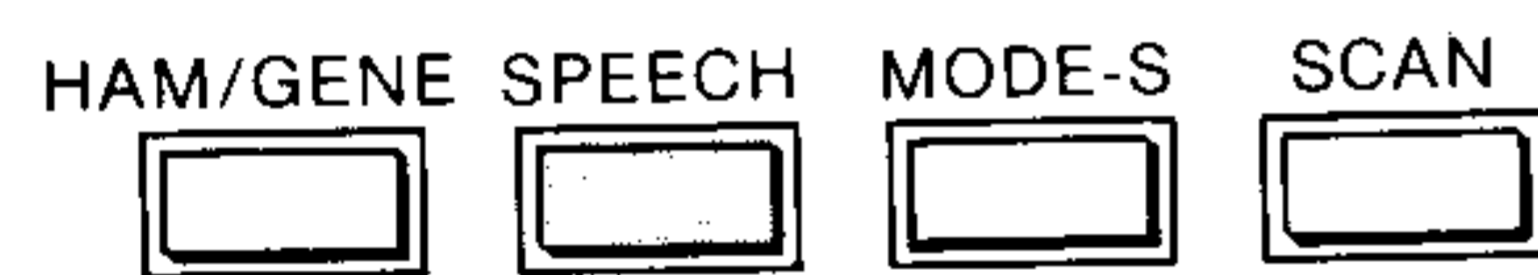

This switch activates the optional IC-EX310 speech synthesizer which announces the displayed frequency in English.

**⑫ MODE SCAN SWITCH [MODE-S]**



This switch engages the selective mode function. Only memory channels with the same operating mode as is displayed just prior to pushing this switch are selected when the **TUNING CONTROL** or the scan function is used. See SECTION 8 for a full description of the IC-751A scanning systems.

**⑬ SCAN START/STOP SWITCH [SCAN]**



This switch starts and stops all scan functions. When the scan restarts, it begins from the frequency on which the scan halted while in the programmed scan mode, or from the highest memory channel while in the memory mode. See SECTION 8 for a full description of the IC-751A scanning systems.

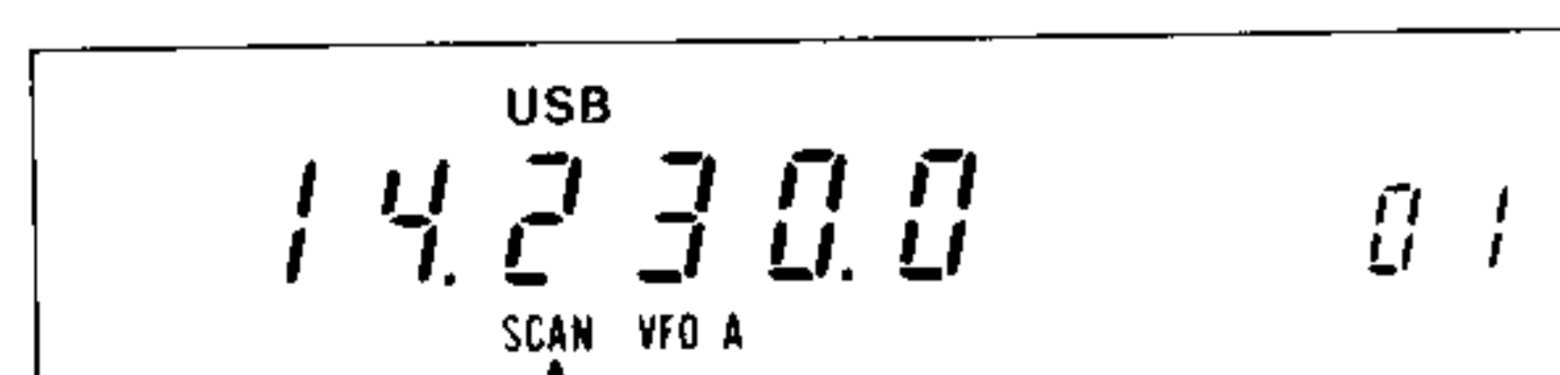

The "SCAN" indicator lights when any scan function is activated.

**⑭ TUNING CONTROL**

Rotate this control clockwise to increase, or counterclockwise to decrease the frequency or memory channel number. The frequency actually changes in 10Hz steps in all operating modes at all times, however, the tuning rate is 10Hz if the control is rotated slowly, but jumps to 50Hz if the control is rotated more rapidly. This allows both fine and coarse tuning of your operating frequency without removing your hand from the **TUNING CONTROL**. Refer to the **TUNING SPEED SWITCH** description below.

**21 DIAL LOCK**

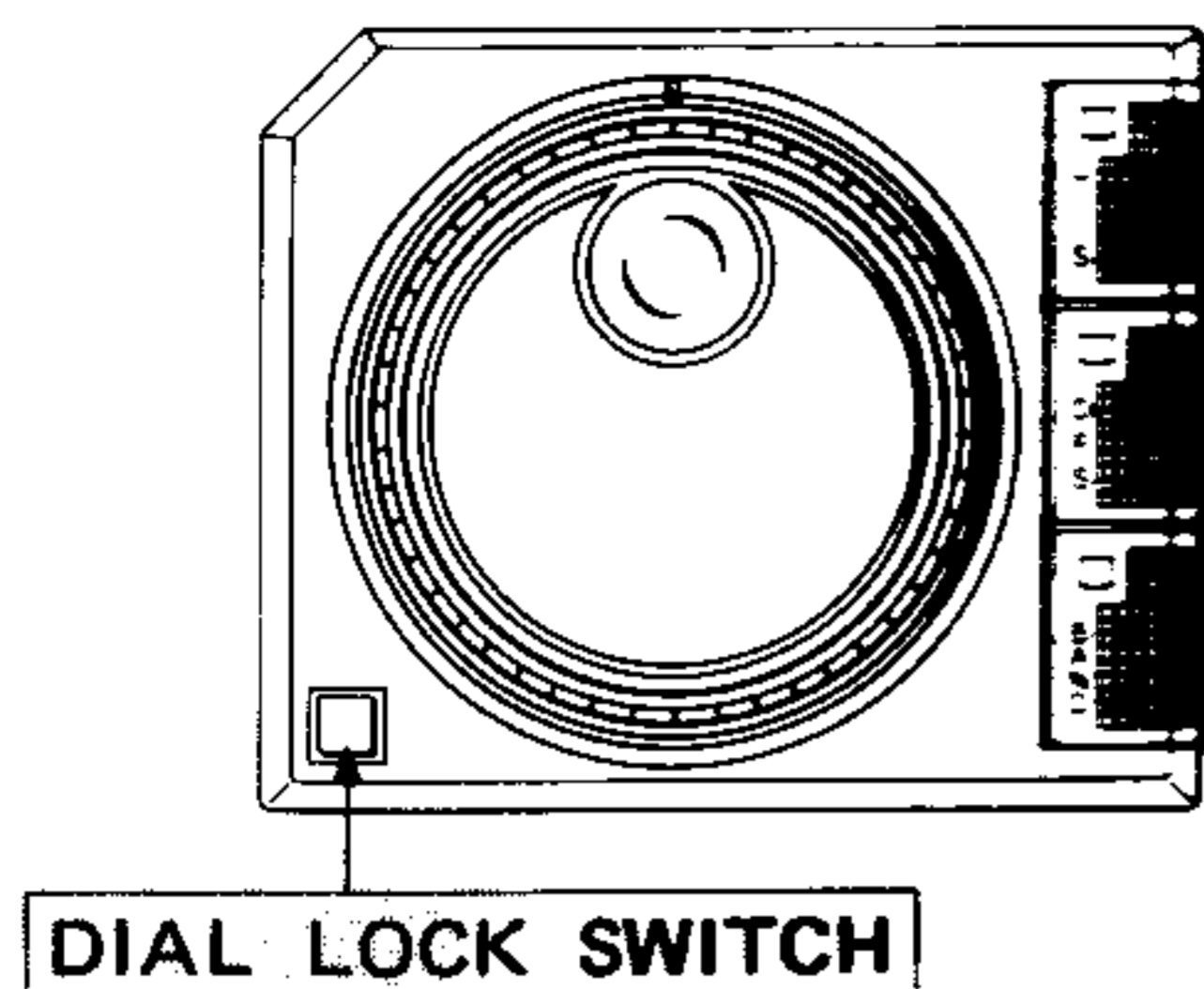

This switch electronically locks the IC-751A on the currently displayed frequency and deactivates the TUNING CONTROL. This function is useful while rag chewing or for mobile operation after the IC-751A is set to the desired frequency. Disengage the dial lock by pushing and releasing the switch.

**22 TUNING SPEED SWITCH [TS]**

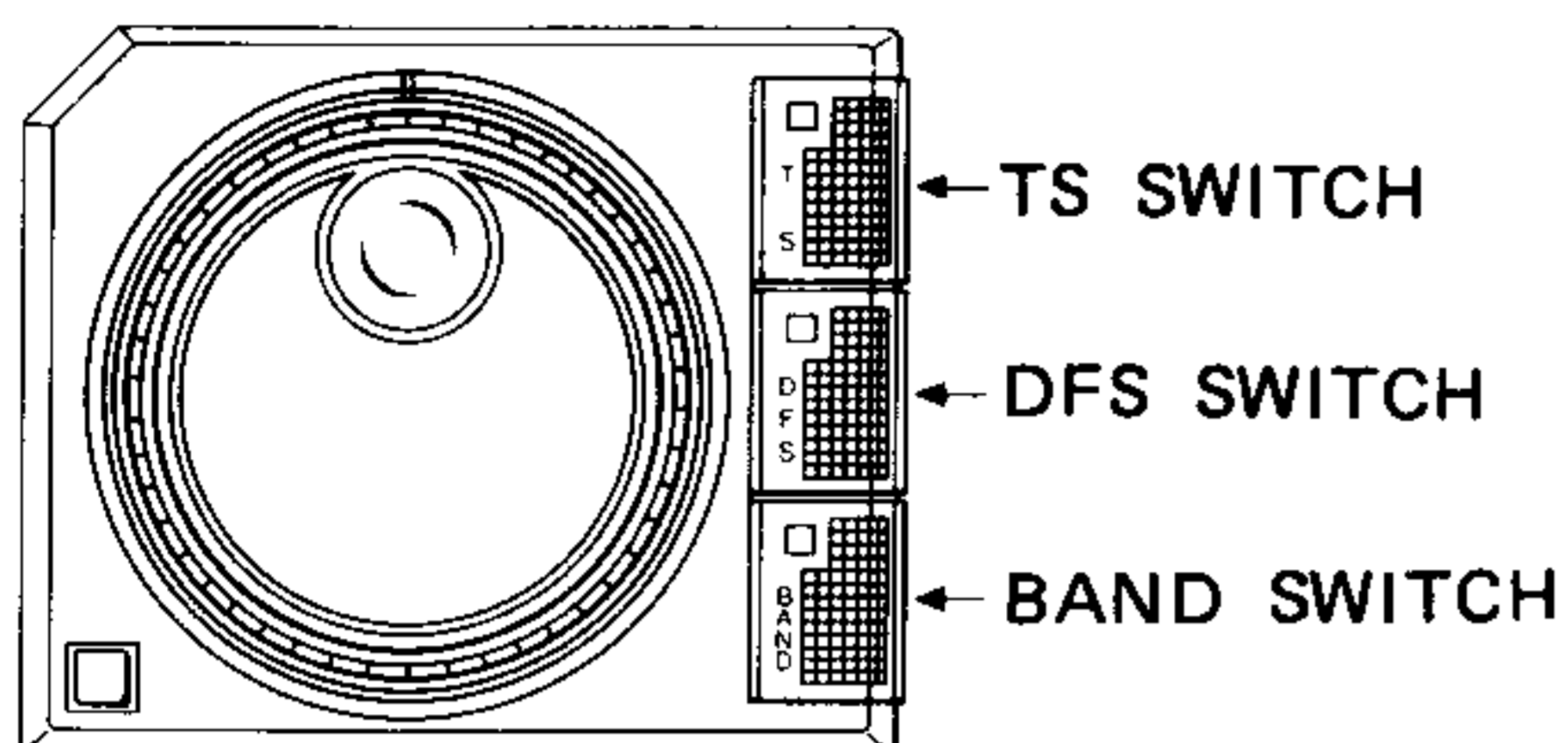

Push this switch to increase the tuning rate to 1kHz while in any operating mode. The 100Hz digit on the frequency display clears to "0" simultaneously. Push and release the switch again to return to the normal tuning rate. Refer to TUNING CONTROL description above.

**23 TS INDICATOR**

Illuminates when the TS SWITCH function is activated.

**24 DIAL FUNCTION SELECT SWITCH [DFS]**

While using the VFO mode, push this switch IN to lock the displayed VFO operating frequency, and rotate the TUNING CONTROL to change the displayed memory channel number.

While using the MEMORY CHANNEL mode, push this switch IN to lock the displayed memory channel, and rotate the TUNING CONTROL to change the displayed frequency.

**25 DFS INDICATOR**

Illuminates when the DFS SWITCH function is activated.

**26 BAND SELECT SWITCH [BAND]**

Push this switch and rotate the TUNING CONTROL in order to change your band of operation. In the HAM BAND mode, the IC-751A jumps to a factory set initialization frequency on each of the amateur bands as the TUNING CONTROL is rotated. In the GENERAL COVERAGE mode, the operating frequency is changed in 1MHz steps.

**27 BAND SELECT INDICATOR**

Illuminates when the BAND SELECT function is activated.

**28 INCREMENTAL TUNING CONTROL [RIT/ $\Delta$ TX]**

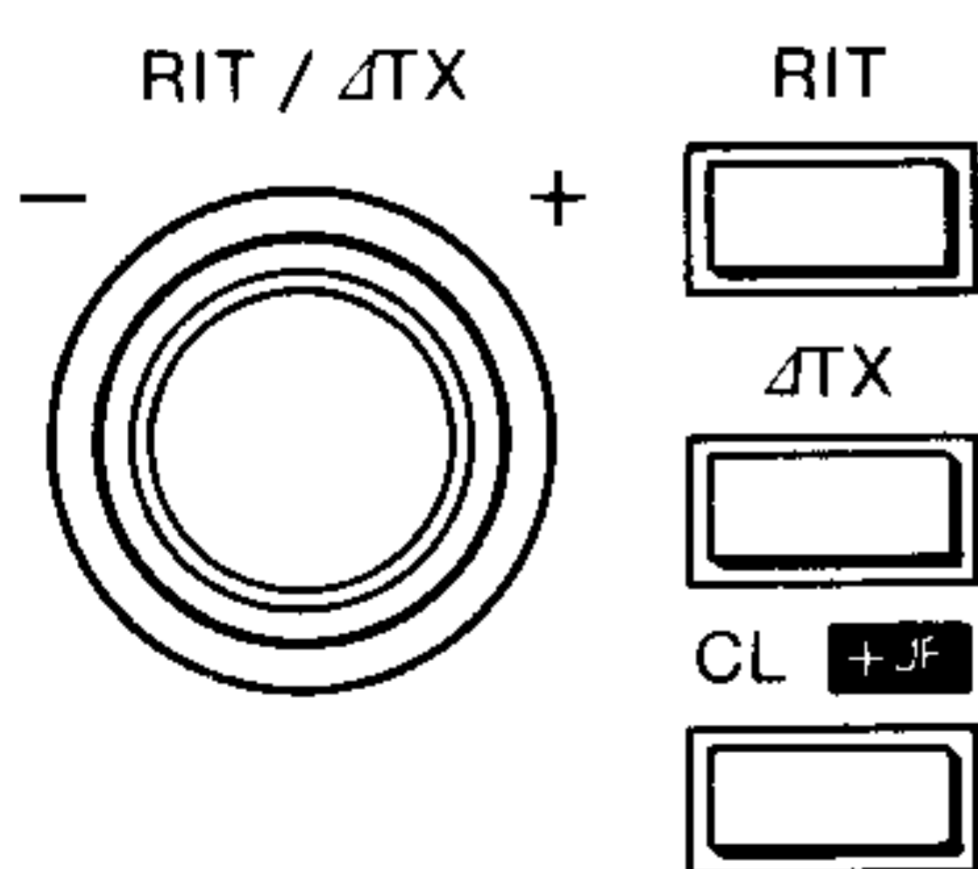

This control shifts the receive or transmit frequency by up to 9.9kHz to either side of the frequency indicated on the main frequency display. Refer to the RIT and  $\Delta$ TX SWITCH descriptions below.

Rotating this control clockwise (+ direction) raises the receive or transmit frequency and counterclockwise (- direction) lowers the frequency. The shifted amount and direction is indicated with smaller numerals to the right of the main frequency display.

When both the RIT and  $\Delta$ TX circuits are ON, both the receive and transmit frequencies may be shifted together to either side of the displayed frequency.

**29 NOTCH FILTER CONTROL**

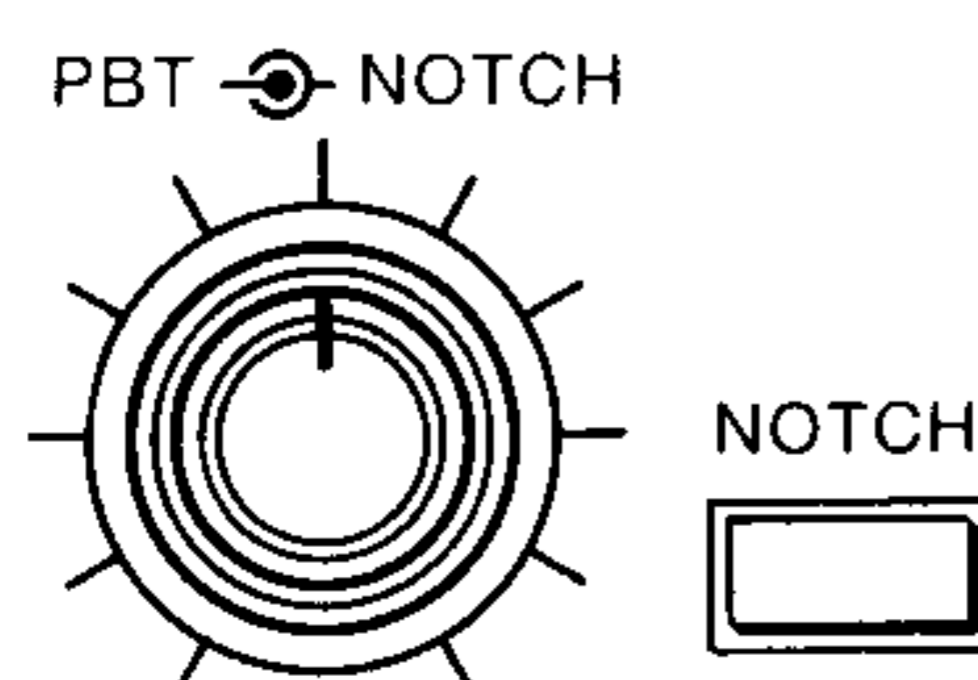

This control shifts the notch filter frequency when the NOTCH SWITCH is ON. Adjust the control to minimize interference. Refer to the description for the NOTCH SWITCH below and see SECTION 7 - 8 for more information.



### 30 PASSBAND TUNING CONTROL

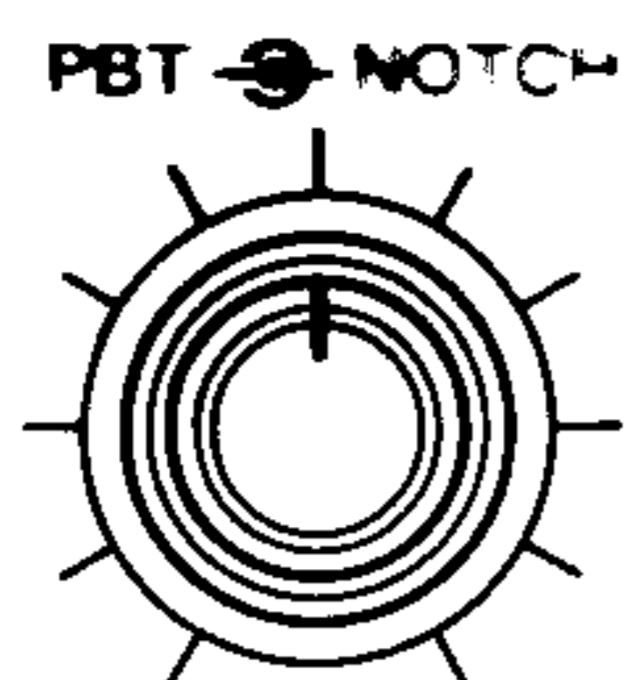

This control allows continuous tuning of the receiver selectivity when using the SSB, CW or RTTY mode. Besides reducing interference on the desired signal, PASSBAND TUNING may also improve the receive audio. The normal position is in the center (12 o'clock) which sets filter bandwidth at 2.3kHz on SSB. Refer to SECTION 7 - 7 for more information.

### 31 RIT SWITCH



This switch turns the variable receive frequency circuit ON and OFF. When the circuit is activated, the letters "RIT" on the front panel illuminate and the amount of shift is indicated. The amount and direction of frequency shift is retained in memory whether the circuit is ON or OFF until erased with the RIT/ $\Delta$ TX CLEAR SWITCH. Refer to the description for the INCREMENTAL TUNING CONTROL and also SECTION 7 - 10 for more information.

### 32 $\Delta$ TX SWITCH



This switch turns the variable transmit frequency circuit ON and OFF. When the circuit is activated, the letters " $\Delta$ TX" on the front panel illuminate and the amount of shift is indicated. The amount and direction of frequency shift is retained in memory whether the circuit is ON or OFF until erased with the RIT/ $\Delta$ TX CLEAR SWITCH. Refer to the description for the INCREMENTAL TUNING CONTROL and also SECTION 7 - 10 for more information.

### 33 RIT/ $\Delta$ TX CLEAR SWITCH



This switch clears the memory which contains the frequency shift information as set with the INCREMENTAL TUNING CONTROL and resets the small incremental tuning display to "0.0".

### 34 FILTER SWITCH



Push the FUNCTION SWITCH first, then this switch in order to add the shifted frequency as shown on the incremental tuning display to the frequency on the main frequency display. The incremental tuning display resets to "0.0". Refer to SECTION 7 - 10 for more information.

This switch selects a different combination of the second IF (9MHz) filter and the third IF (455kHz) filter to vary the overall selectivity as shown in the following chart.

FILTER SWITCH	SSB	CW/RTTY	CW/RTTY NARROW	AM	FM
OUT	2.3kHz	500Hz	500/250Hz	8kHz	15kHz
IN	2.6kHz	2.3kHz	500/250Hz	3kHz	15kHz

Refer to SECTION 7 - 9 for more information.

### 35 NOTCH FILTER SWITCH



This switch controls the notch filter circuit.

- Notch Filter OFF: Switch OUT
- Notch Filter ON: Switch IN

### 36 VFO A/B SWITCH [A/B]

This switch selects either VFO A or VFO B for tuning purposes.

### 37 VFO EQUALIZING SWITCH [A=B]

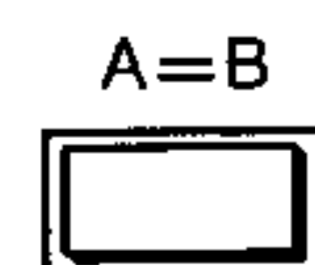

This switch instantly matches the frequency and mode of operation of the two VFOs. The display does not change when this switch is pushed, however confirmation of the equalizing process is possible by pushing the A/B SWITCH to check the frequency and mode of the opposite VFO.

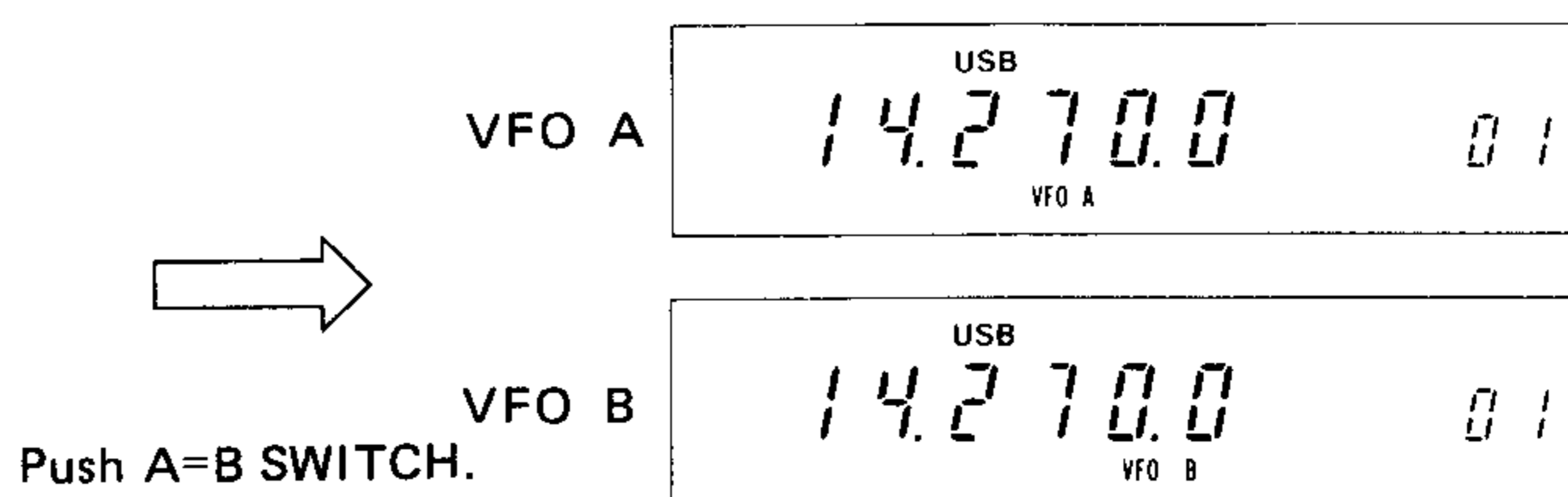
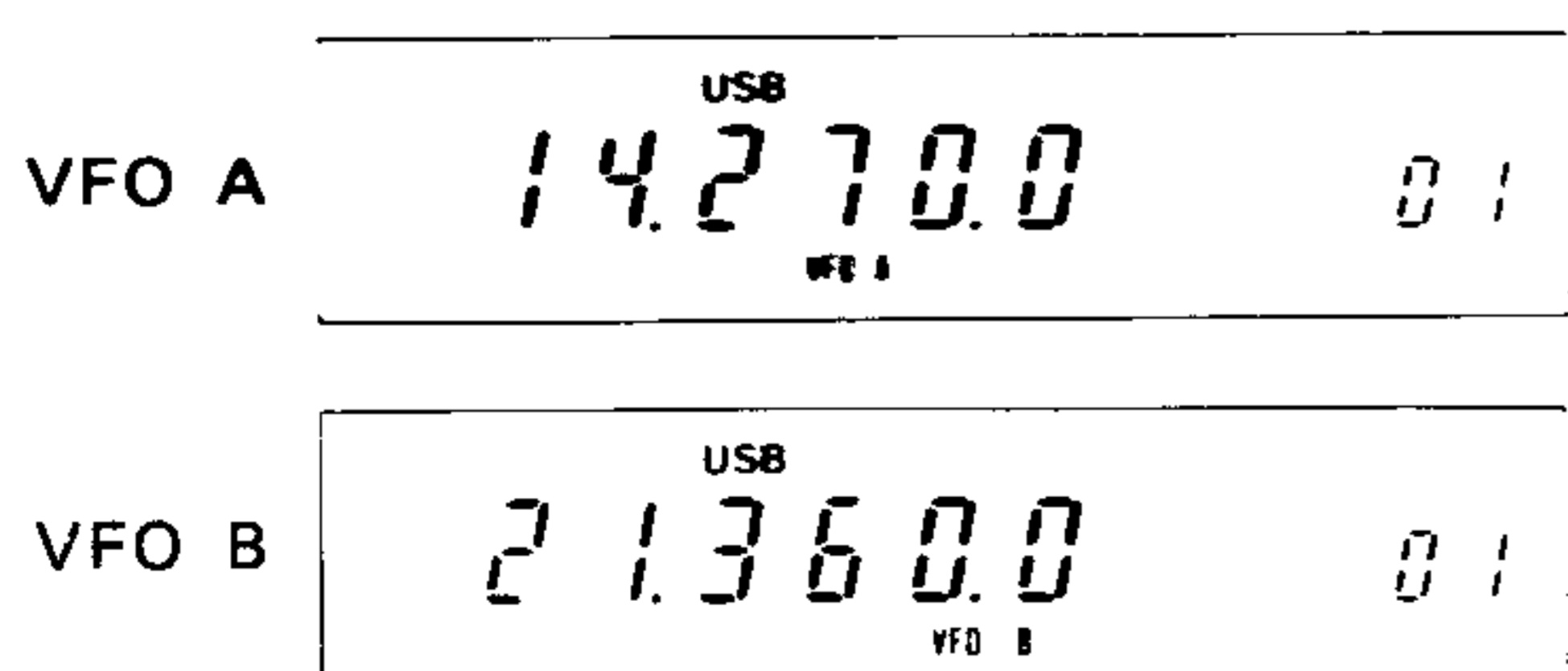

**38 SPLIT (DUPLEX) SWITCH**

This switch determines whether one VFO is used for both transmitting and receiving, or whether both VFO A and VFO B are used.

- Single VFO operation : SPLIT SWITCH OUT.
- Dual VFO operation : SPLIT SWITCH IN.

Refer to SECTION 7 - 5 for more information.

**39 VFO/MEMORY SWITCH [VFO/M]  
[VFO/M]**

This switch selects either the VFO or MEMORY CHANNEL mode for tuning purposes.

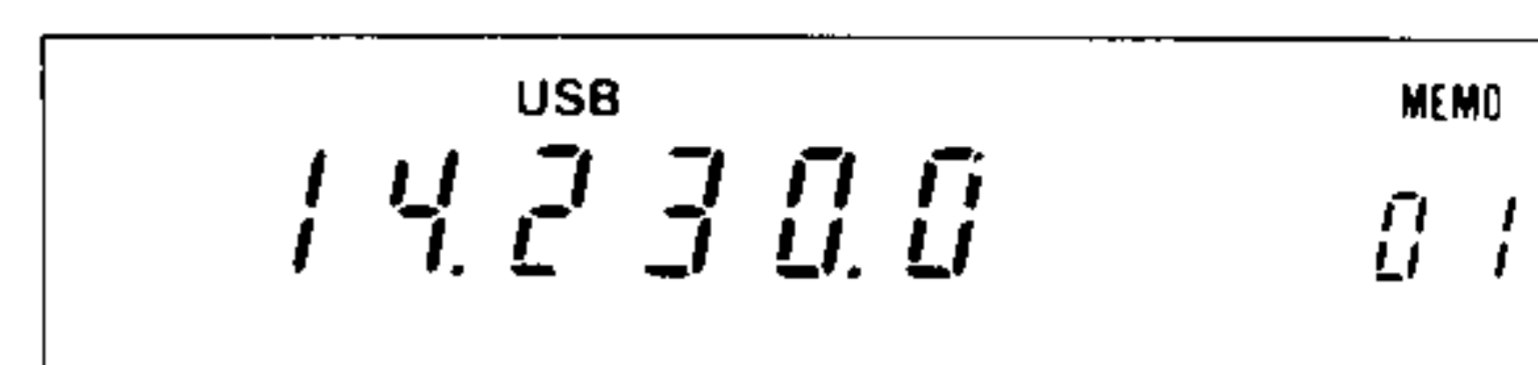
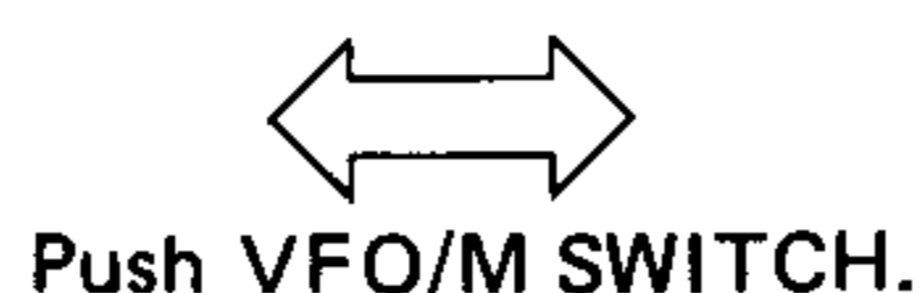
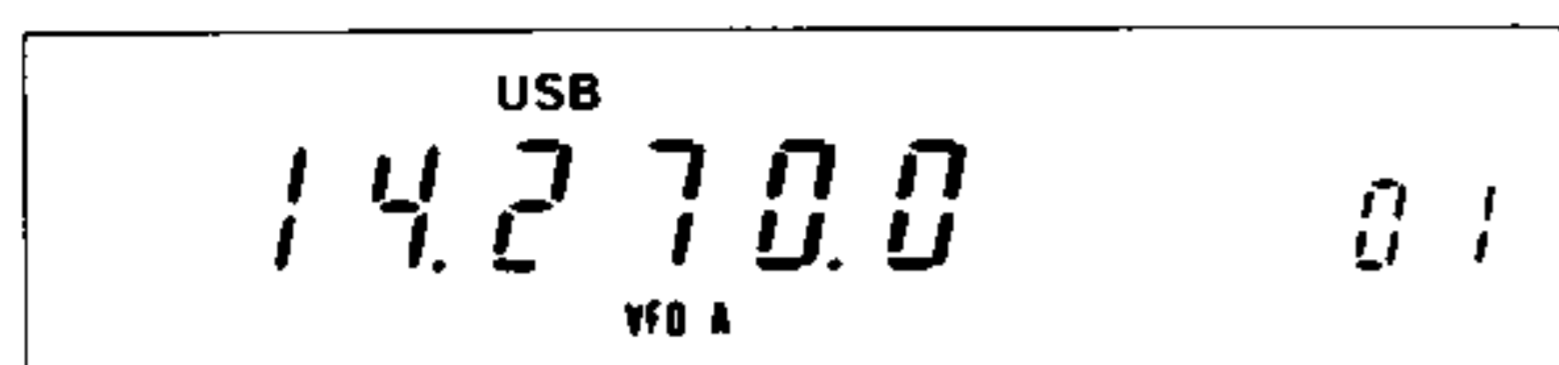

**40 MEMORY WRITE SWITCH [WRITE]**

This switch stores the displayed operating frequency and mode information in the memory channel indicated on the frequency display. Memory writing is possible in either the VFO or MEMORY CHANNEL mode. Refer to SECTION 8 - 2 for information on programming the memory channels.

**41 FREQUENCY TRANSFER SWITCH  
[M ▶ VFO]**

This switch operates differently depending on which mode the IC-751A is in.

- In the VFO mode, the frequency and mode stored in the memory channel displayed transfer to the selected VFO.
- In the MEMORY CHANNEL mode, the displayed frequency and mode transfer to the VFO used immediately prior to changing to the MEMORY CHANNEL mode.

**NOTE:** When in the MEMORY CHANNEL mode, it is the displayed frequency which transfers to the VFO. This is not necessarily the MEMORY CHANNEL frequency since the TUNING CONTROL and DFS SWITCH may have been used to shift the operating frequency. Information stored in the memory channel remains unchanged after using the M ▶ VFO function.

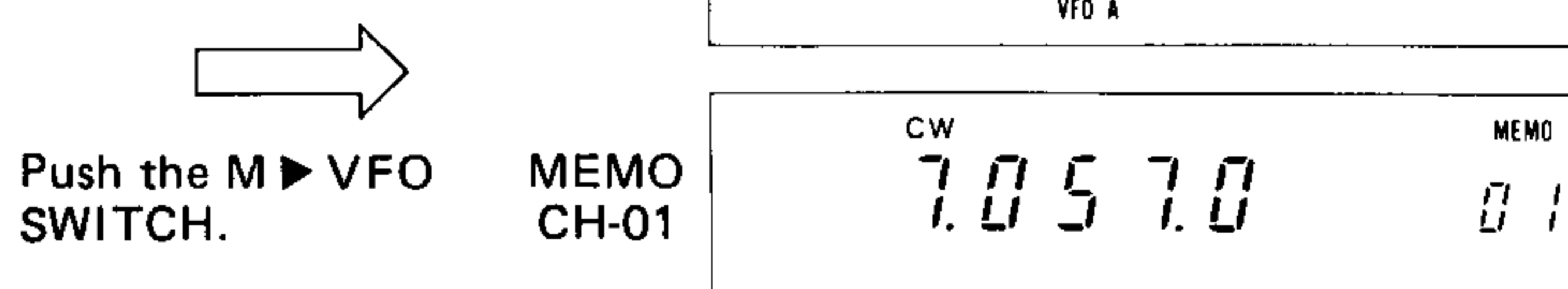
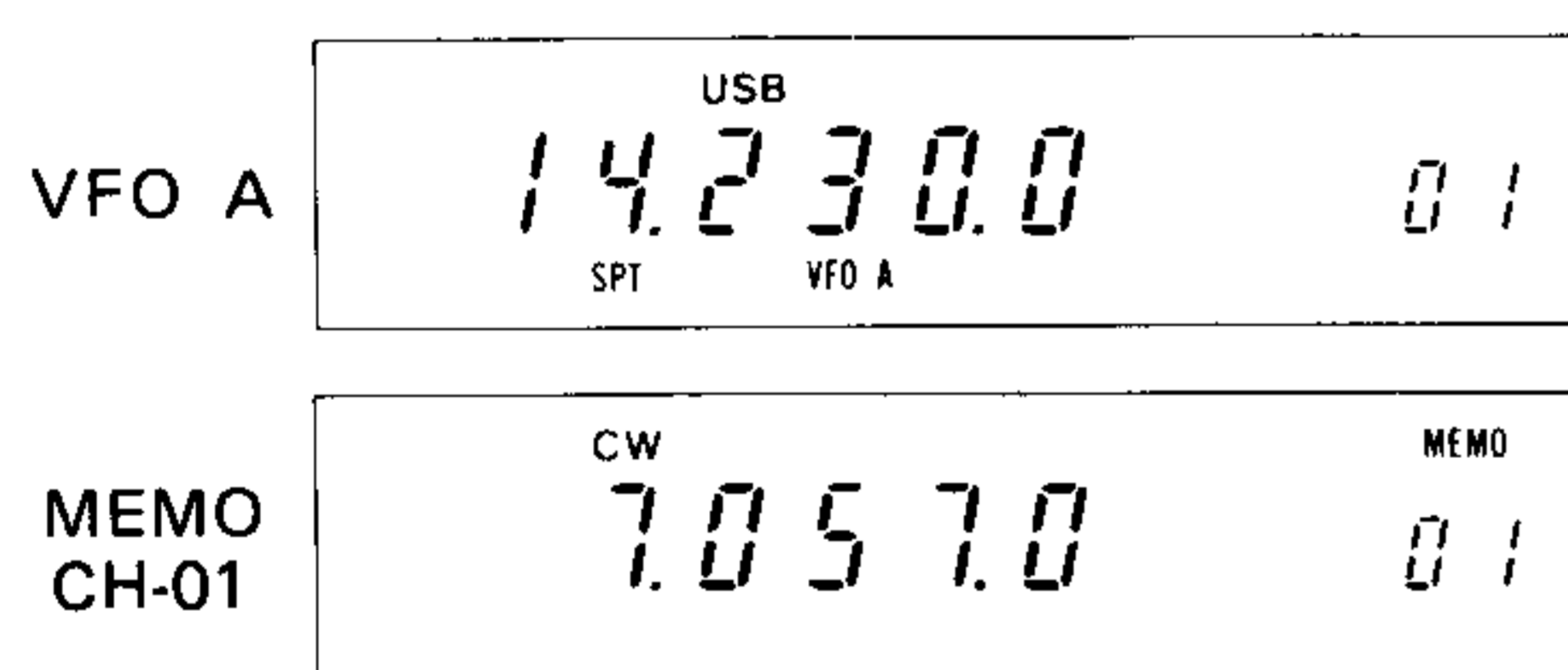

**42 FREQUENCY DISPLAY**

Refer to SECTION 3 - 2 for a description of the frequency display.

**43 TRANSMIT INDICATOR**

This indicator illuminates when the IC-751A is in the transmit mode.

**44 RECEIVE INDICATOR**

This indicator illuminates when the IC-751A is in the receive mode.

**45 NARROW FILTER INDICATOR**

This indicator illuminates when the narrow CW or RTTY filter is selected. If the filter is not installed, the indicator still lights when the narrow positions are selected, however the audio output is muted.

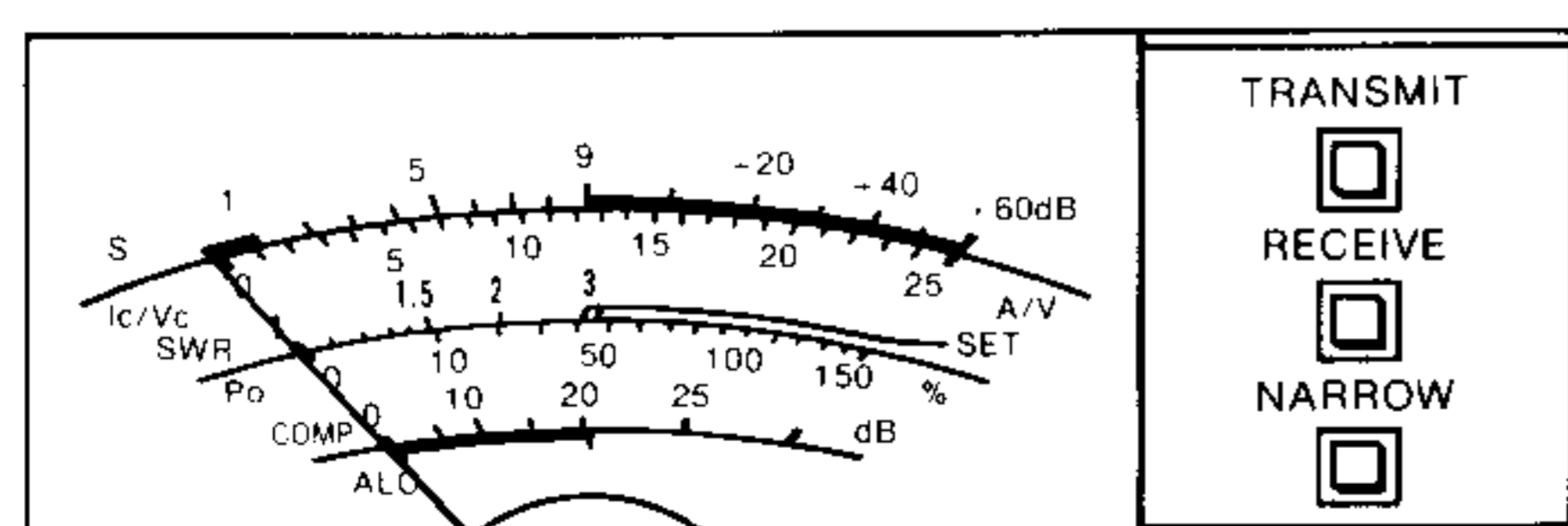

**④⑥ MULTIFUNCTION METER**

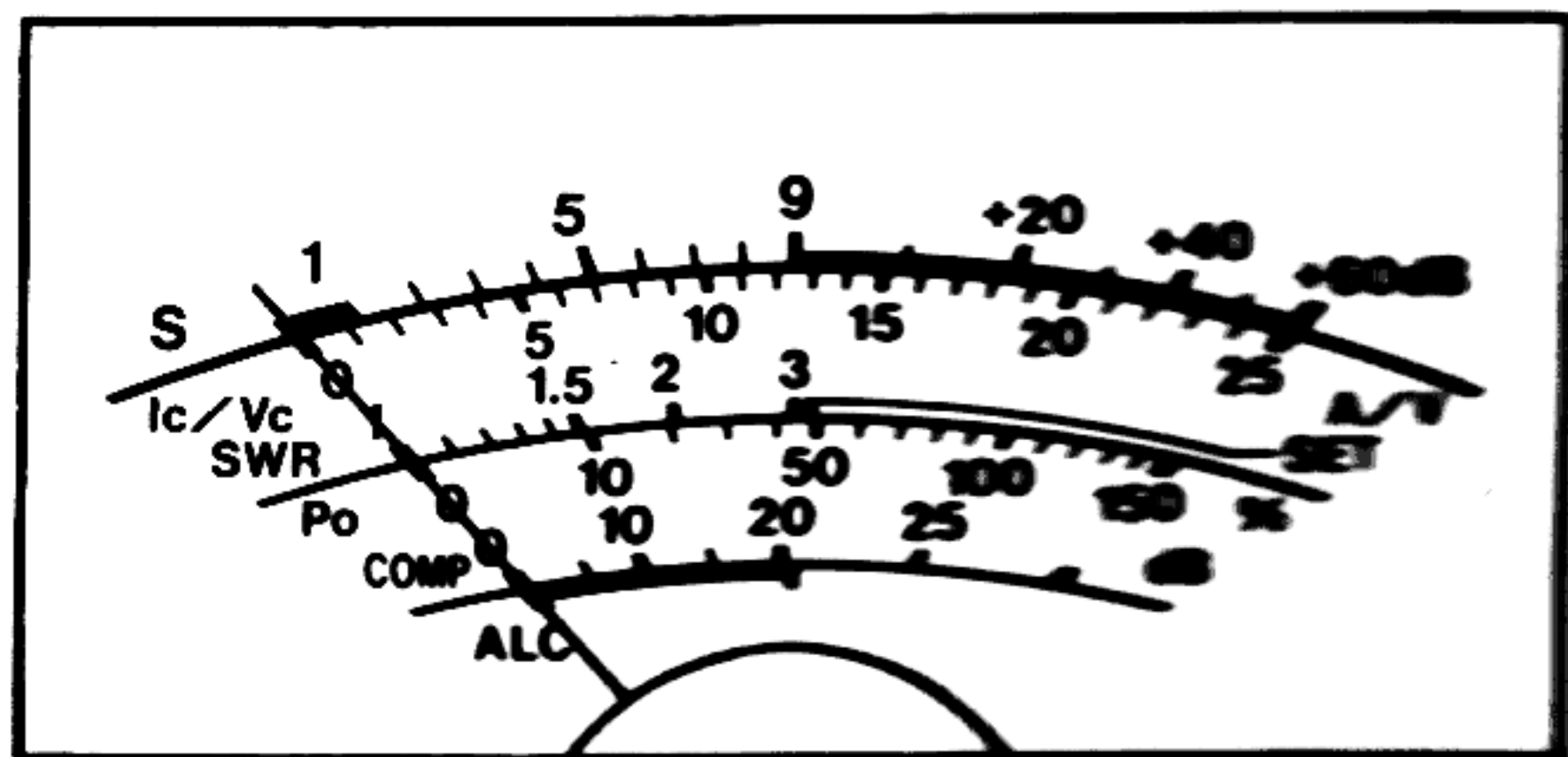

In the receive mode, the IC-751A front panel meter acts as an S-meter (signal strength meter). In the transmit mode, the meter has six different functions as stated in Item ③ METER SWITCH.

**④⑦ NOISE BLANKER TIMING SWITCH [NB WIDE]**

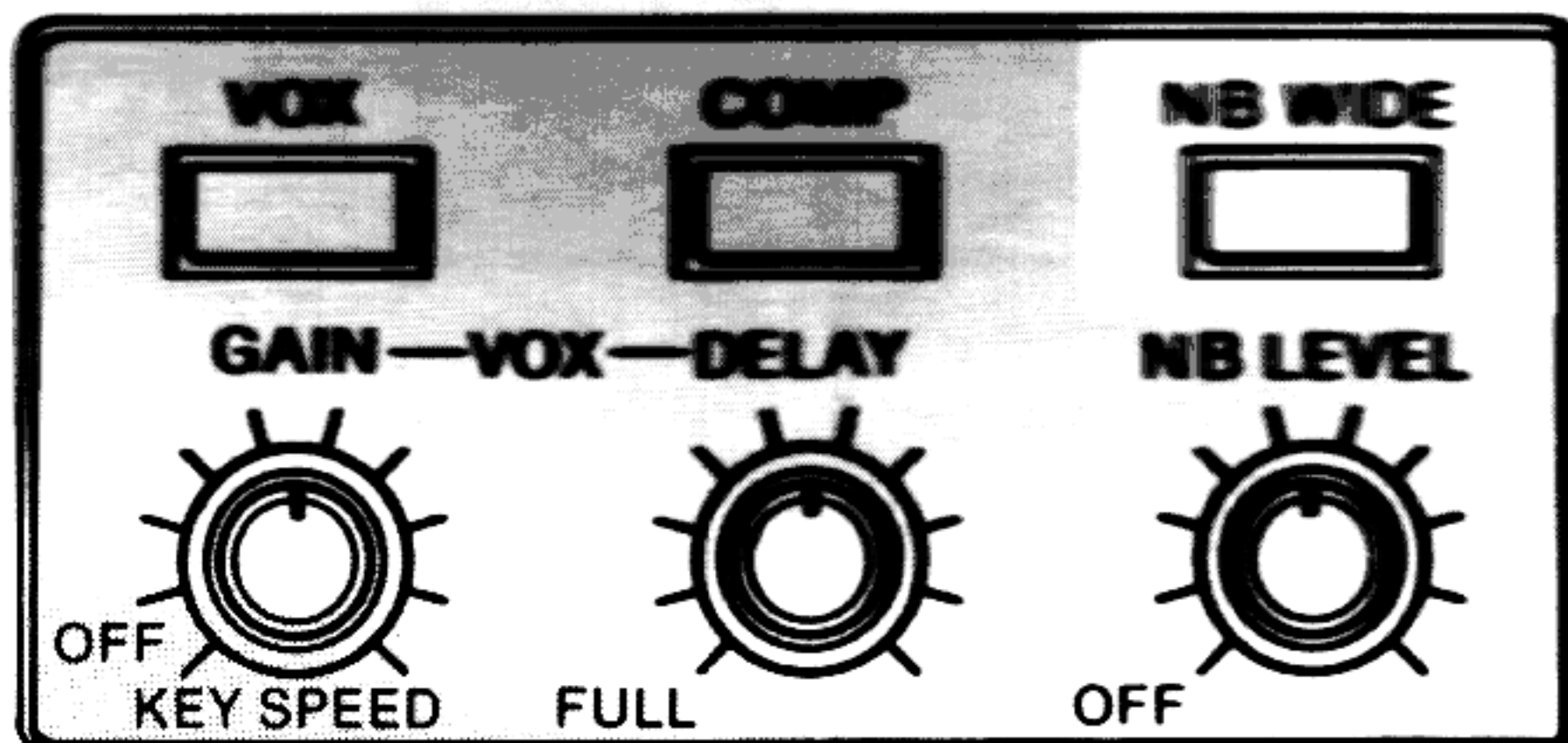

The blanking time of the noise blanker circuit may be set for **NORMAL** or **WIDE** with this switch. Use this switch in conjunction with the **NOISE BLANKER LEVEL CONTROL** described in Item ⑤②.

**④⑧ SPEECH COMPRESSOR SWITCH [COMP]**

This switch turns the RF speech compressor circuit ON and OFF. The circuit provides greater talk power by improving the intelligibility of the transmitted signal over long distances.

**④⑨ VOX SWITCH**

This switch turns the VOX circuit ON and OFF. The automatic T/R switching VOX circuit functions in the PHONE and CW modes when the switch is IN. In CW, semi break-in or full break-in operation is possible.

**● SEMI BREAK-IN, FULL BREAK-IN OPERATION**

Semi break-in operation refers to automatic switching of the transceiver between the transmit and receive modes in unison with the operator's speech or the closing and opening of the CW telegraph key.

Full break-in operation, usable only with CW, is the same except the transceiver switches even more rapidly after each element of an individual letter is sent. Full break-in operation closely simulates full duplex communication.

**⑤⑩ VOX GAIN CONTROL**

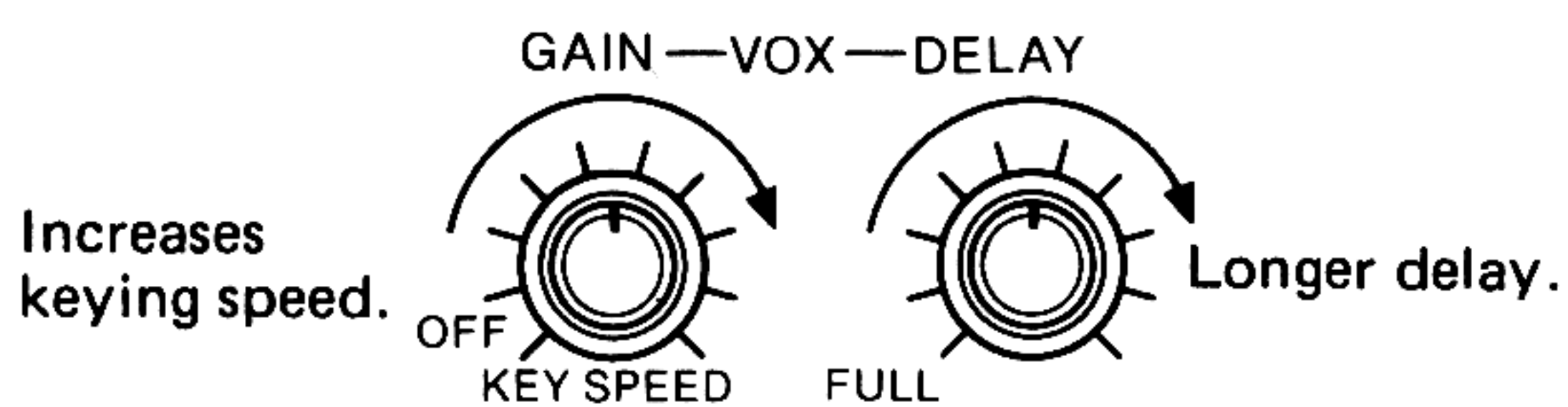

This control increases and decreases the sensitivity of the VOX circuit. When operating in the CW mode, iambic keyer operation is possible.

- When operating in the SSB, AM or FM mode, adjust the control so the VOX circuit activates with a normal speech level.
- When operating in the CW mode, this control turns the electronic keyer unit ON and OFF, plus varies the speed (5-45 wpm) of the unit. When the control is OFF, manual CW operation is possible.

**⑤⑪ VOX DELAY CONTROL (VOX time constant)**

This control changes the transmit to receive switching time. Adjust it so transmit to receive switching occurs during pauses in your speech or CW transmission.

**⑤⑫ NOISE BLANKER LEVEL CONTROL [NB LEVEL]**

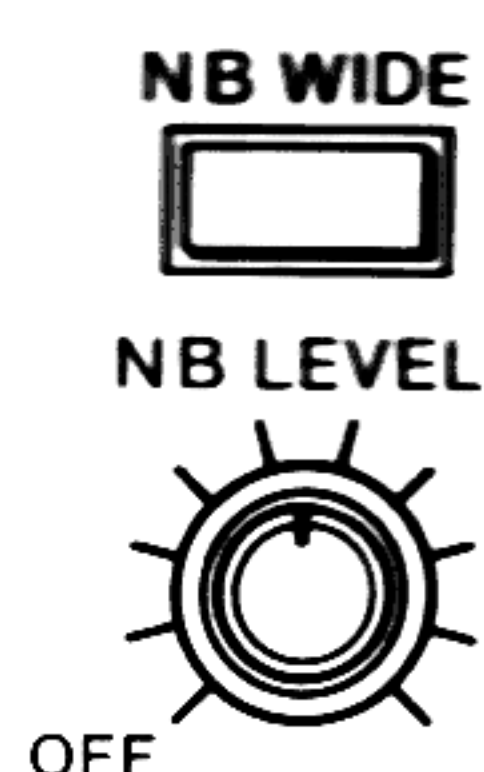

This control varies the threshold level of the noise blanker. Adjust to remove the noise without adding distortion to the received signal.

### 3-2 FREQUENCY DISPLAY

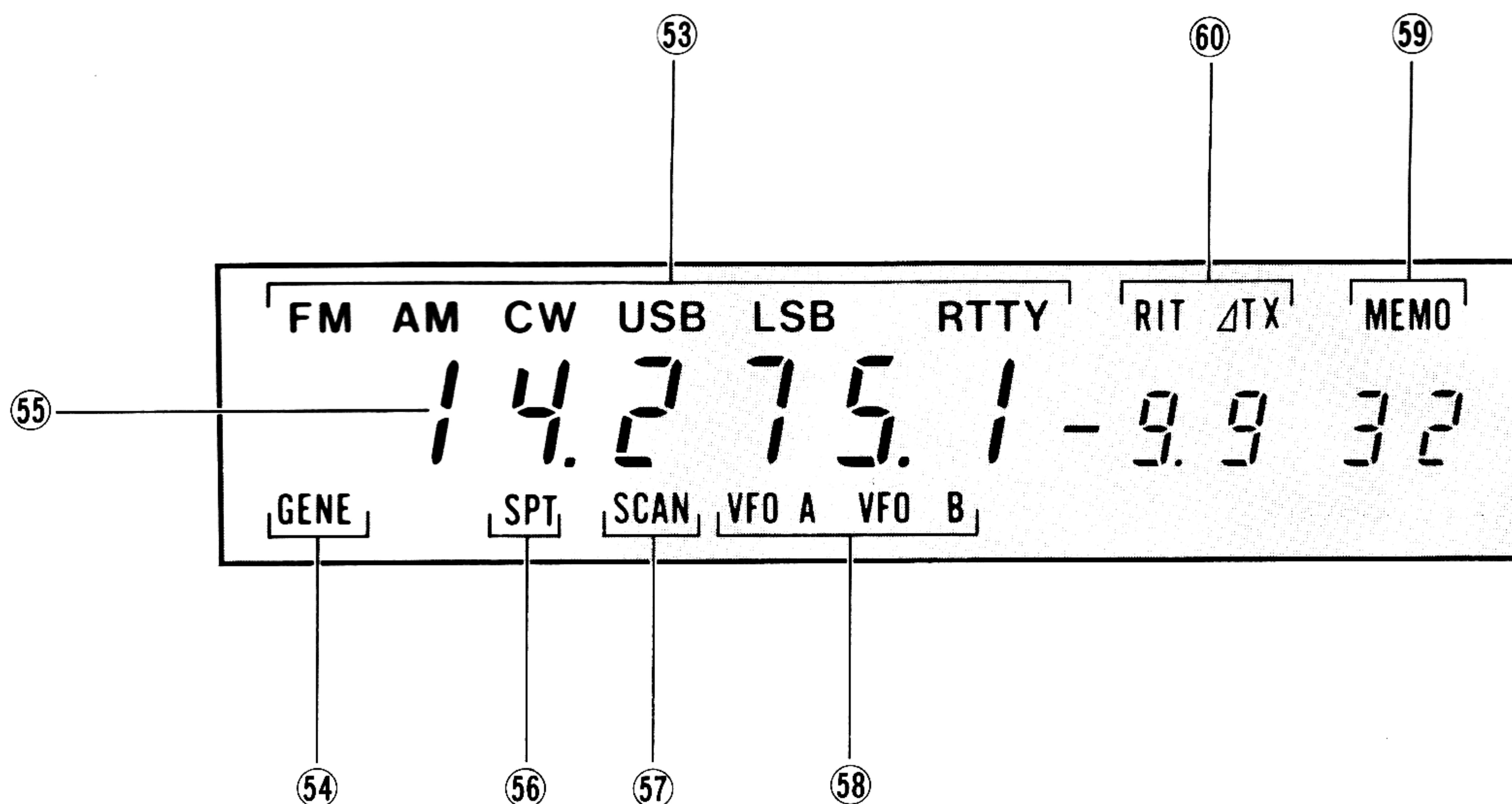

#### 53 MODE INDICATOR

This area of the display shows the operating mode currently selected. The modes available are FM, AM, CW, USB, LSB or RTTY.

#### 54 GENERAL COVERAGE INDICATOR

"GENE" lights when the IC-751A is in general coverage mode. When "GENE" is not lit, the transceiver is in the HAM BAND mode.

#### 55 FREQUENCY READOUT

This readout shows the operating frequency using 6 digits and 100Hz resolution.

#### 56 SPLIT INDICATOR

"SPT" lights when separate VFOs are used for the transmit and receive frequencies. This allows operation with a transmit frequency which is different from the receive frequency. When "SPT" is not illuminated, a single VFO is used for both transmit and receive.

#### 57 SCAN INDICATOR

"SCAN" lights whenever a scan function is selected.

#### 58 VFO INDICATOR

"VFO A" or "VFO B" lights to indicate which VFO is currently selected.

#### 59 MEMORY INDICATOR

"MEMO" lights when the memory mode is selected. The selected memory channel number from 01 to 32 is also shown.

#### 60 SHIFT FREQUENCY INDICATOR

"RIT" or "ΔTX" lights when the receive or transmit incremental tuning function is activated, respectively. The direction and quantity of the shift is also shown. Both functions may be activated simultaneously if desired. Refer to SECTION 7 - 10 for more information.

### 3-3 TOP PANEL

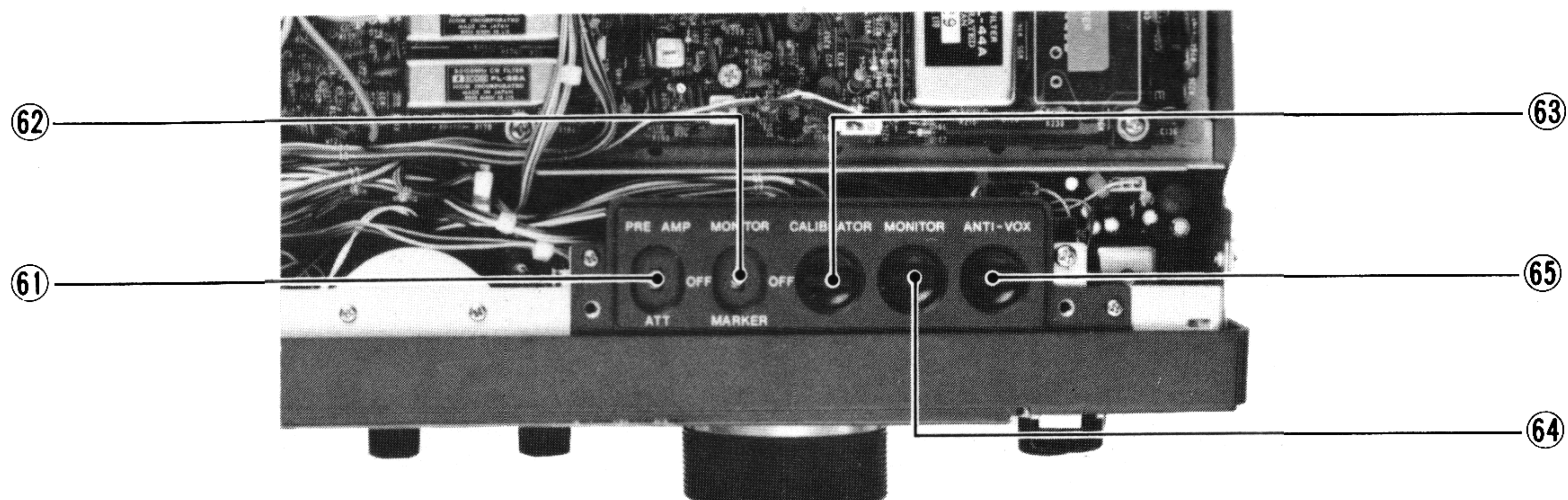

**61) PREAMP/ATT (Attenuator) SWITCH**

This switch selects the RF preamplifier to amplify weak receive signals or the RF attenuator to prevent overloading of the receiver. Refer to SECTION 7 - 14 for more information.

**62) MONITOR/MARKER SWITCH**

This switch turns the MONITOR or MARKER circuit ON or OFF.

• Vary the monitor level with the MONITOR LEVEL CONTROL.

• A calibration marker is generated every 10kHz when the circuit is activated.

**63) MARKER CALIBRATOR**

This control varies the marker frequency. Use an accurate standard frequency source such as radio station WWV/WWVH to calibrate the marker generator. See SECTION 12 - 3 (2) for more information.

**64) MONITOR LEVEL CONTROL**

This control changes the audio level of the CW sidetone or SSB monitor circuit when the MONITOR SWITCH on the top panel is turned ON. Adjust the control for the desired monitor volume.

**65) ANTI-VOX CONTROL**

When using the VOX function, sound from the speaker may cause unwanted switching of the T/R relay. Adjust this control in conjunction with the VOX GAIN CONTROL so the T/R relay switches only from the operator's voice and not from the speaker audio.

**3 - 4 REAR PANEL**

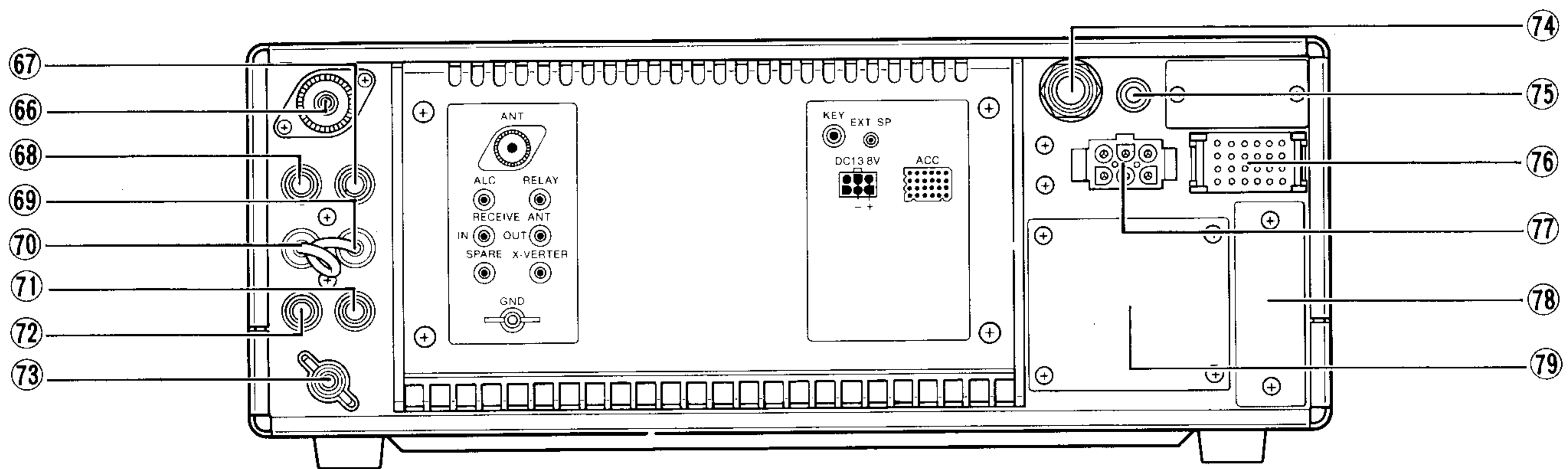

**66) ANTENNA CONNECTOR**

Connect a 50 ohm impedance antenna to this connector. The connector mates with a PL-259 plug.

**67) T/R CONTROL JACK [RELAY]**

An output signal from this jack controls the transmit/receive switching of an external amplifier or transverter.

**NOTE:** DO NOT attempt to switch greater than 50 volts, 0.5 ampere.

**68) EXTERNAL ALC JACK [ALC]**

This jack accepts an automatic level control signal from an external amplifier or transverter. The ALC voltage must be in the range of 0 volts to -4 volts.

**69) RECEIVE ANTENNA OUTPUT [RECEIVE ANT OUT]**

The receive signals from the ANTENNA CONNECTOR pass through the transmit/receive antenna switching circuit to this jack. Normally, the receiver IN and OUT jacks are connected together with a jumper. The ANTENNA OUTPUT JACK is useful when operating with a separate receiver or an external preamplifier.

**⑦① RECEIVER INPUT [RECEIVE ANT IN]**

This is an input jack which connects to the receiver RF stage.

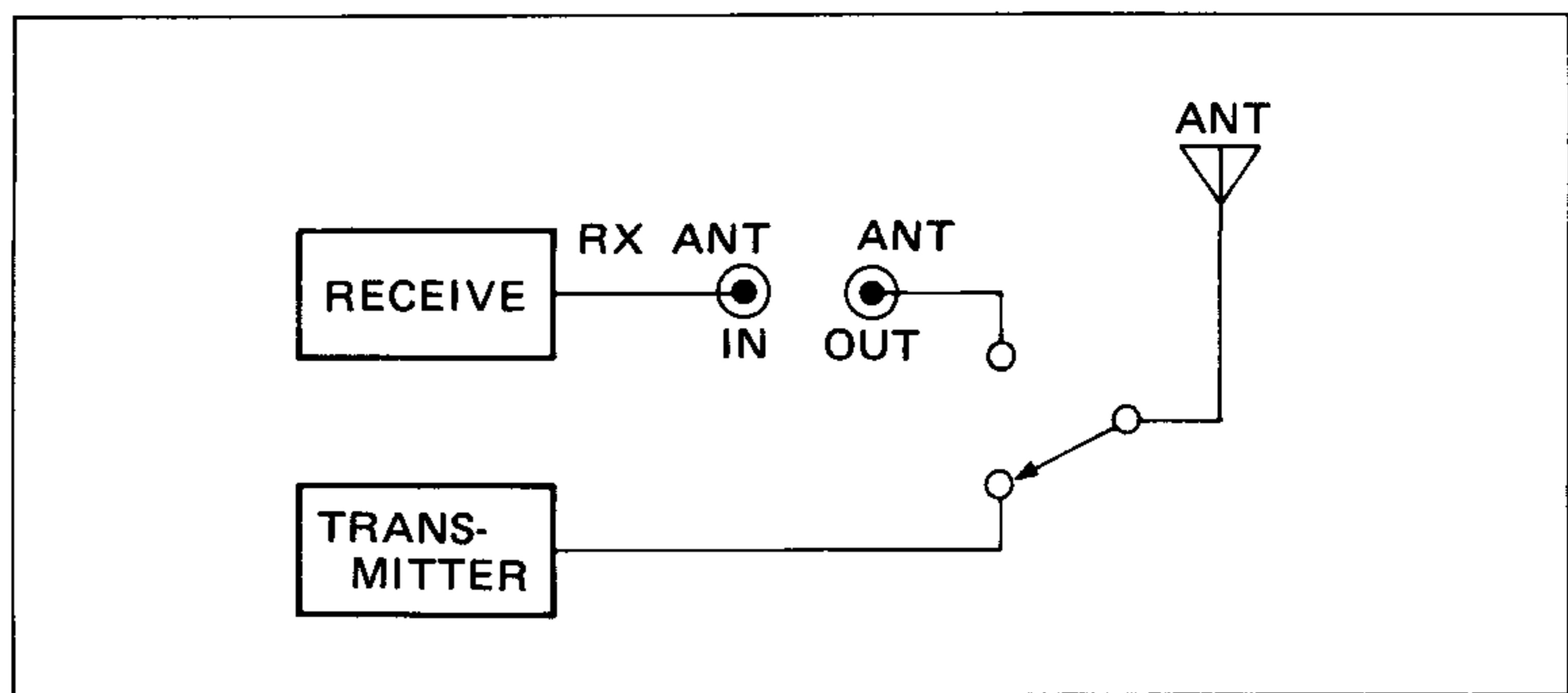

**⑦① TRANSVERTER JACK [X-VERTER]**

Connect a suitable transverter to this jack for operation on VHF/UHF frequencies. The output is approximately 30mV.

**⑦② SPARE JACK**

This jack is not used. It may be useful for connecting a personal accessory.

**⑦③ GROUND TERMINAL**

To prevent electrical shocks, TVI, BCI and other problems, be sure to ground the equipment through the **GROUND TERMINAL**. For best results, use the heaviest gauge wire or strap available and make the connection as short as possible.

**⑦④ KEY JACK**

For CW operation, connect a CW key using the supplied standard 1/4 inch, 3-conductor plug. The terminal voltage from external electronic keyers must be less than 0.4 volts DC.

When using the IC-751A internal iambic keyer, connect an iambic keyer paddle using the supplied 1/4 inch, 3-conductor plug. See SECTION 4 - 5 and 6 - 4 for more information.

**⑦⑤ EXTERNAL SPEAKER JACK**

Connect an external speaker to this jack, if required. Use a speaker with an impedance of 4 ~ 16 ohms and remember the built-in speaker does not function when using the **EXTERNAL SPEAKER JACK**.

**⑦⑥ ACCESSORY SOCKET**

This socket provides signals such as T/R switching, receiver output, modulation output, etc. Refer to SECTION 5 - 6 for more information.

**⑦⑦ DC POWER SOCKET [DC 13.8V]**

Connect the DC power cable from the IC-PS35 internal power supply, the IC-PS30 or IC-PS15 external power supply or other suitable supply. Refer to SECTION 4 - 6 for more information.

**⑦⑧ IC-EX309 (OPTIONAL) INTERFACE UNIT CONNECTOR POSITION**

This position is for the installation of the DP-25 connector from the optional IC-EX309 interface unit.

**⑦⑨ IC-PS35 (OPTIONAL) AC POWER SUPPLY SOCKET POSITION**

This position is for the installation of the AC power socket when the optional IC-PS35 internal power supply is used.

## SECTION 4 INSTALLATION

### 4 - 1 PLANNING

Select a location for your transceiver which allows free access to the front panel controls, good air circulation and rear clearance for access to the rear panel connections.

- **Mobile or marine installations:**

An optional IC-MB18 mounting bracket is available to mount your IC-751A. Select a location which can support the weight of the unit, and which does not interfere with the normal operation of the vehicle or boat. Provide protection from direct rain on boats.

- **PRECAUTIONS**

**Avoid** using the IC-751A in the following situations:

- 1) Where temperatures under  $-10^{\circ}\text{C}$  or over  $+60^{\circ}\text{C}$  are encountered. For example, DO NOT use the IC-751A in areas exposed to direct sunlight or near heat-producing devices such as heaters or ranges.
- 2) In humid or moist places including bathrooms.

**DO NOT** run the antenna feedline near electronic instruments or magnetic compasses.

### 4 - 2 MOUNTING THE TRANSCEIVER

The optional IC-MB18 mounting bracket allows installation of the transceiver to a surface over the IC-751A. When mounting the transceiver aboard a boat, place the bracket in a location which minimizes vibration and wave shock.

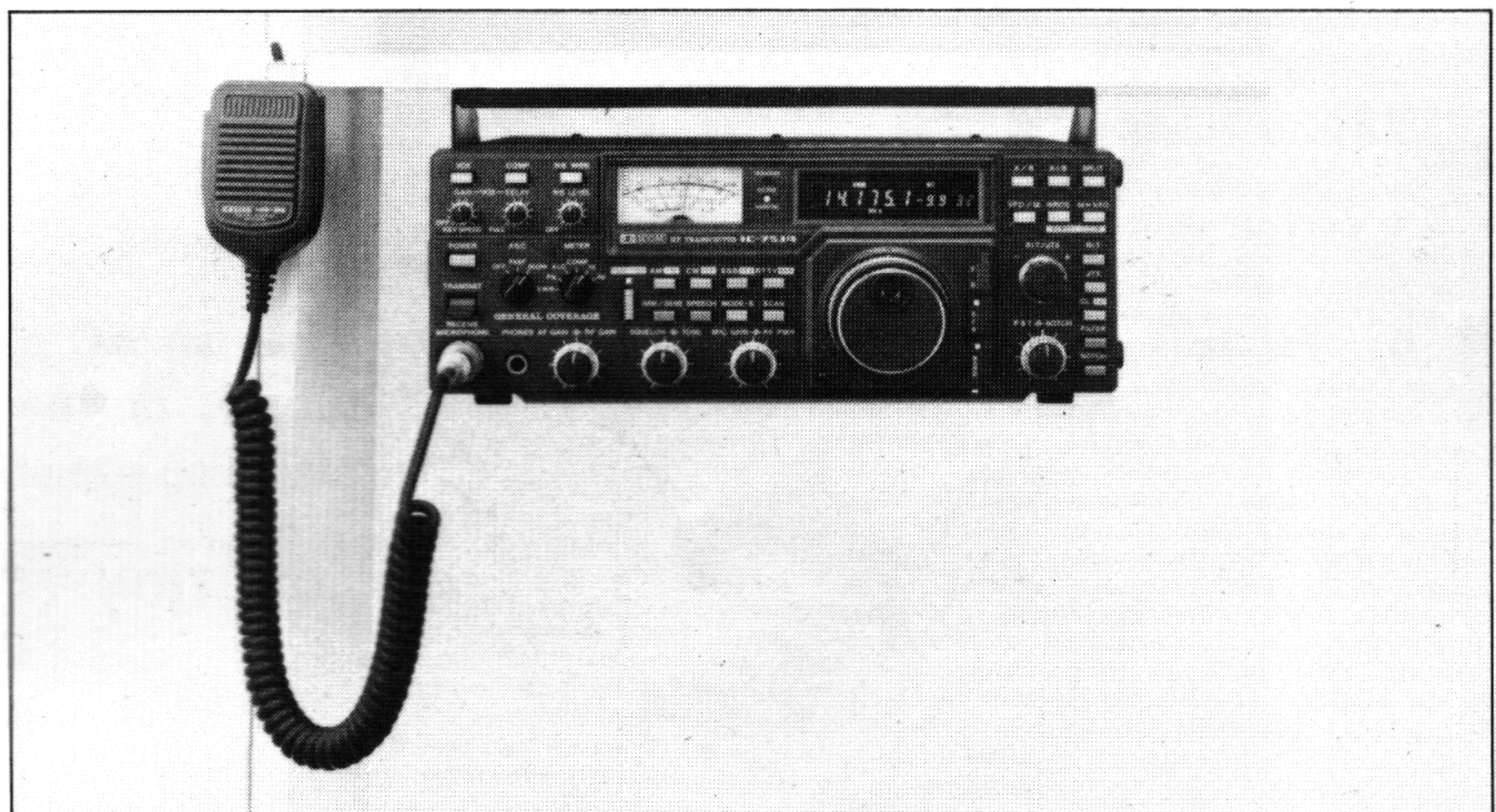

### 4 - 3 ANTENNA

Antennas play a very important role in radio communication. If the antenna is inferior, your transceiver cannot give you the best performance. A well-matched 50 ohm antenna and feedline will provide the desired performance.

Since the IC-751A comes standard with a general coverage receiver, it is recommended that a long wire antenna and antenna tuner be used when receiving outside the Amateur bands. The tuner will ensure there is a matched condition at all times. An Amateur band antenna generally does not give adequate performance when used on frequencies for which it was not designed.

- **MOBILE ANTENNA**

**NOTE:** To install the AH-2, an OPC-137 interface cable must be purchased separately.

The ICOM AH-2 Antenna System may be bumper-mounted, plus it offers automatic band switching and tuning in unison with the IC-751A.

#### 4 - 4 MICROPHONE

The supplied HM-36 electret condenser hand microphone or optional SM-8 or SM-10 desk microphone may be used. Merely plug it into the MICROPHONE CONNECTOR on the front panel. If you wish to use a different microphone, make certain it has the proper output level. Particular care must be exercised when wiring a different microphone since the transceiver internal electrical switching system is dependent upon the correct connections. See SECTION 3 - 1 FRONT PANEL Item ⑤ for MIC CONNECTOR connections.

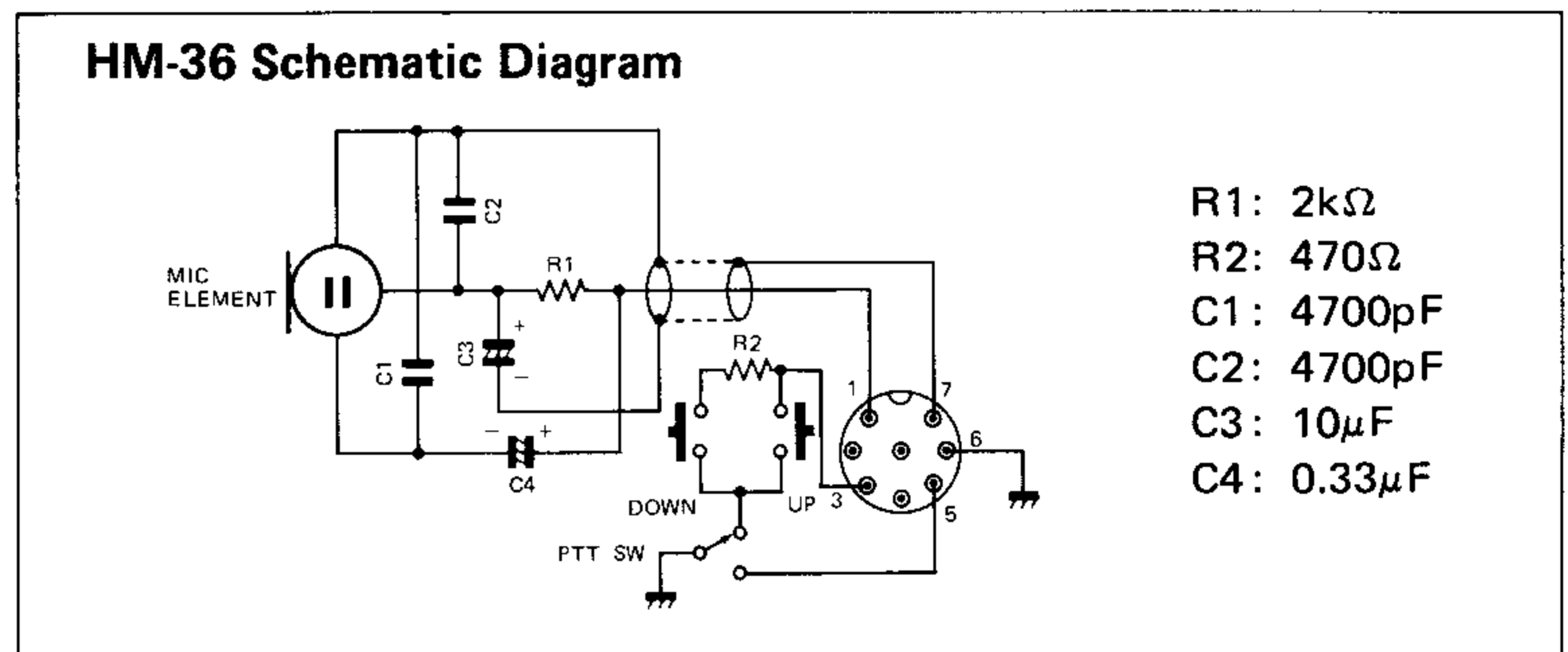

#### 4 - 5 CW KEY

For CW operation, connect a CW key to the KEY JACK using the supplied standard 1/4 inch, 3-conductor plug. See the diagrams for connection details.

Note that the keyed voltage when switching with semiconductors or relays with resistors in the circuit must be less than 0.4 volts.

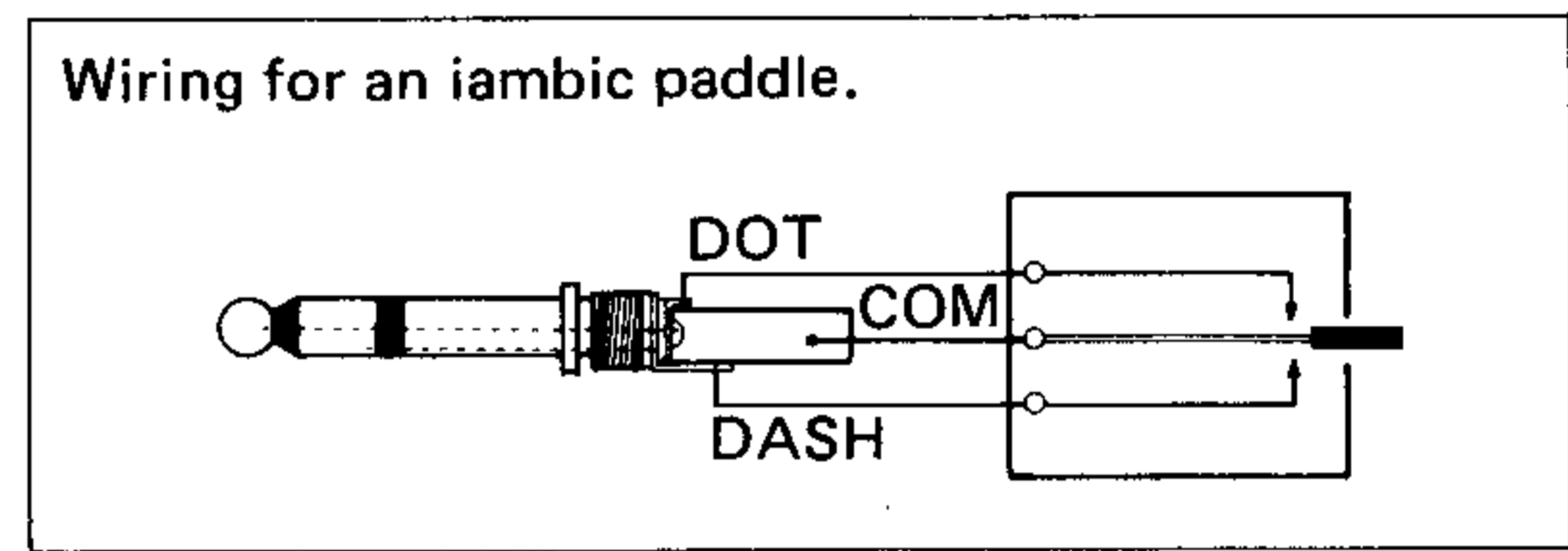
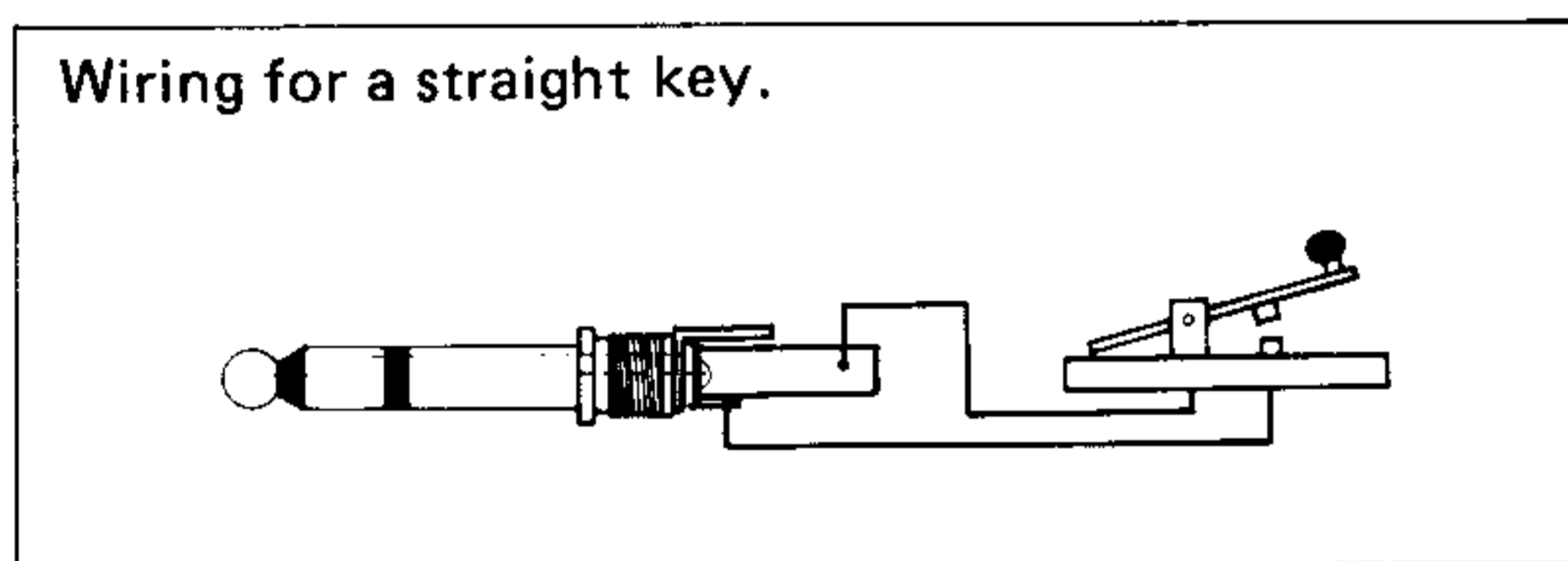

#### 4 - 6 POWER SUPPLY

When an AC power supply is required, the IC-PS35 internal power supply, or the IC-PS30 or IC-PS15 external power supply with matching size and style is recommended.

**CAUTION:** Voltages greater than 15 volts DC may damage this transceiver. Check the source voltage before connecting the power cable when using with non-ICOM AC power supplies.

#### ● AC OPERATION WITH THE IC-PS30

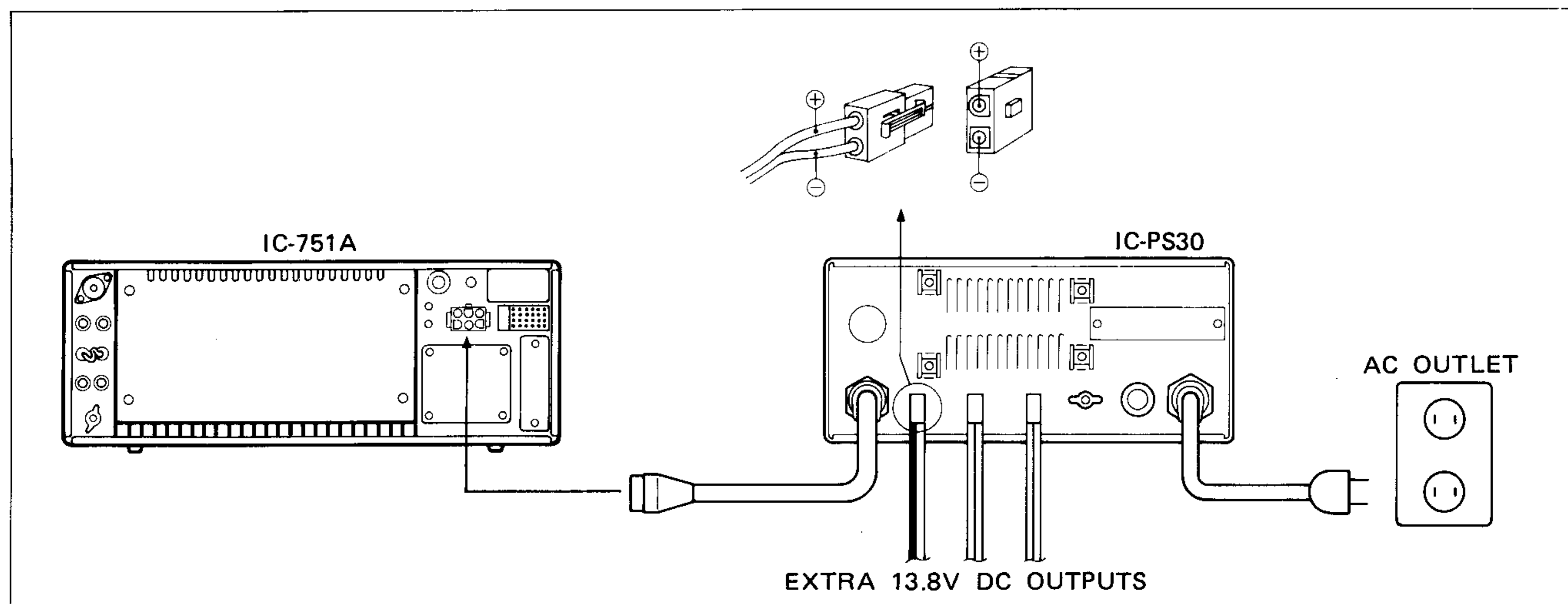



●AC OPERATION WITH THE IC-PS15

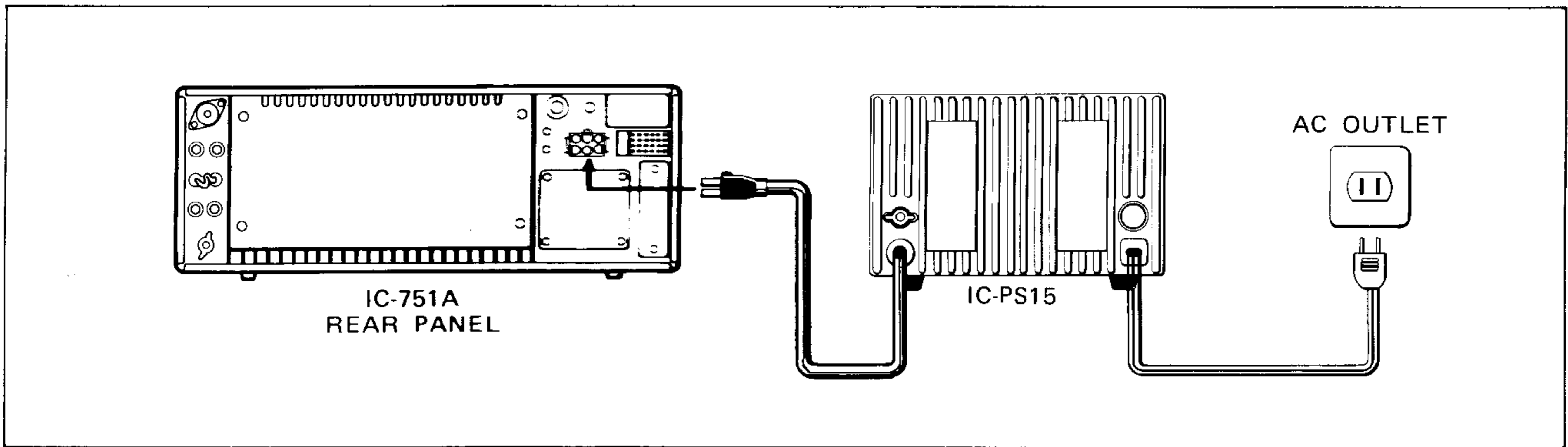

●AC OPERATION WITH NON-ICOM AC POWER SUPPLIES

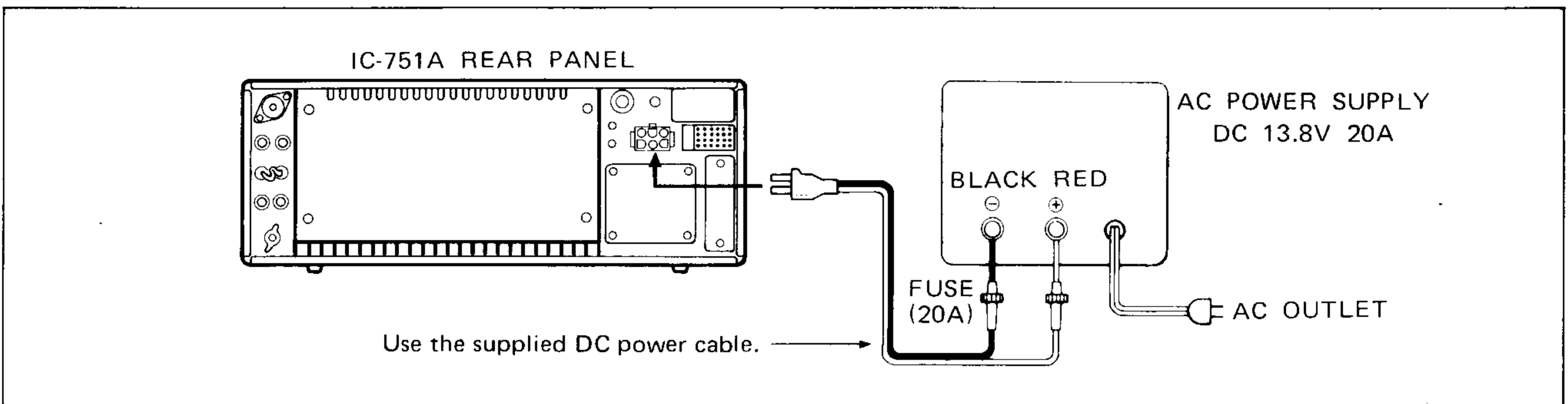

●DC OPERATION WITH DC POWER SOURCE

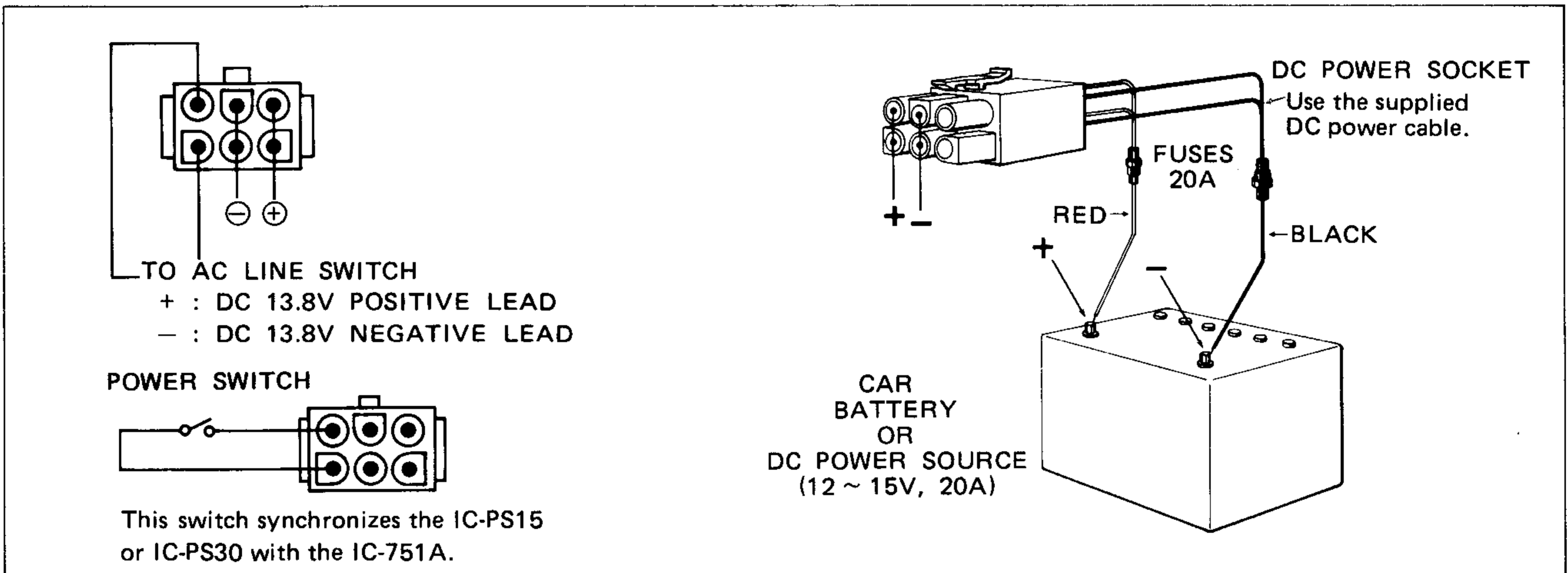

**CAUTION:** For safety purposes, remember to install FUSES in the DC cable when connecting the IC-751A to a vehicle battery. Locate the fuses as close to the car battery as practical.

4 - 7 GROUND

To prevent electrical shocks, TVI, BCI and other problems, be sure to ground the equipment with the heaviest gauge wire or strap available from a good ground to the GROUND TERMINAL on the rear panel.

## SECTION 5 SYSTEM INTERCONNECTIONS

### 5-1 AC POWER SUPPLY

Refer to SECTION 4 - 6 for installation directions.

### 5-2 EXTERNAL LINEAR AMPLIFIER

The IC-751A is designed to operate into a load with 50 ohms impedance. Therefore, any amplifier used must have a 50 ohm input impedance for best efficiency.

#### ● USING THE IC-2KL LINEAR AMPLIFIER

The optional 500 watt, solid-state IC-2KL linear amplifier may be easily connected to the IC-751A with the cables supplied with the amplifier in the same way as other ICOM transceivers. Refer to the IC-2KL Instruction Manual for details.

**NOTE:** All cables required for the interconnection of the IC-751A and the IC-2KL are supplied with the amplifier.

It is recommended that the ICOM IC-AT500 Automatic Antenna Tuner be used when operating with the IC-2KL and 500 watts output (See SECTION 15). The amplifier connections are shown below.

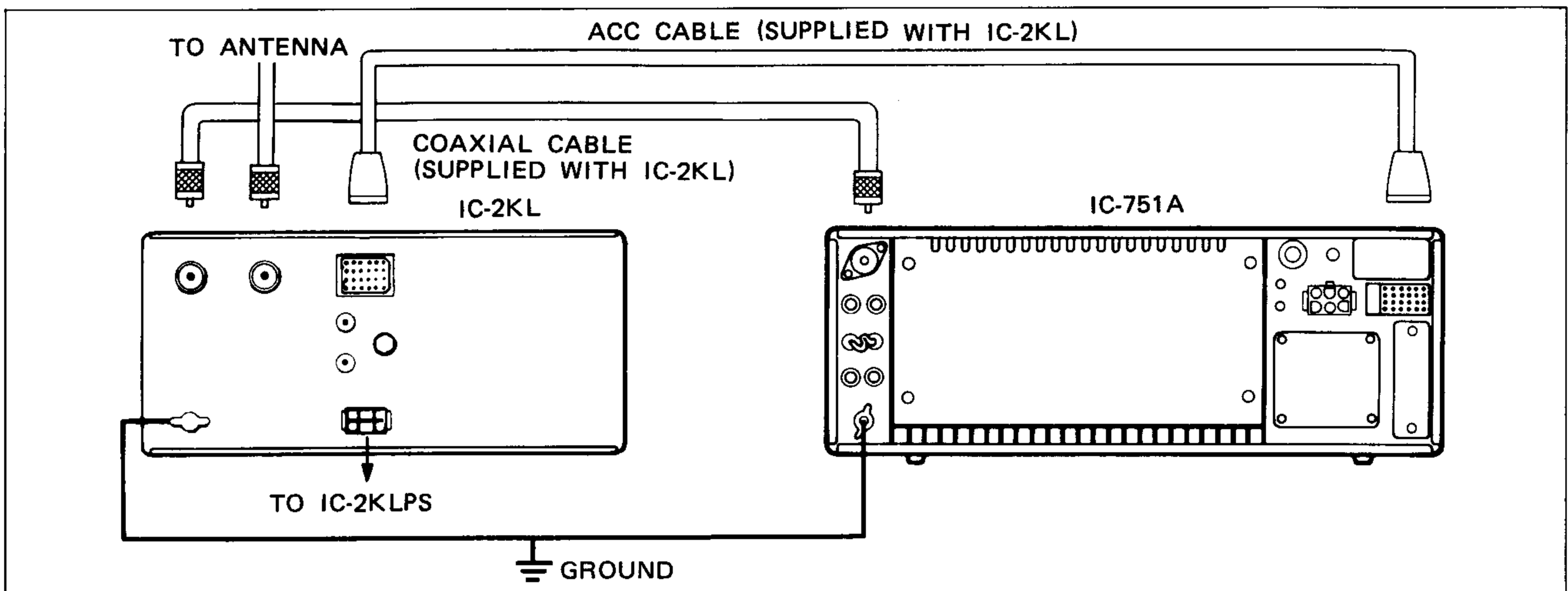

#### ● USING NON-ICOM EXTERNAL AMPLIFIERS

The RELAY JACK on the rear panel of the IC-751A supplies an output from a built-in keying relay for an external amplifier. The ALC jack is an input for the automatic level control signal from an external amplifier.

The specification for the keying relay is 50 volts DC maximum. Do not exceed this limit.

The RELAY JACK is grounded while the transceiver is in the transmit mode and it opens when the transceiver returns to the receive mode. The output condition of this jack does not control either the transmit or receive function of the transceiver.

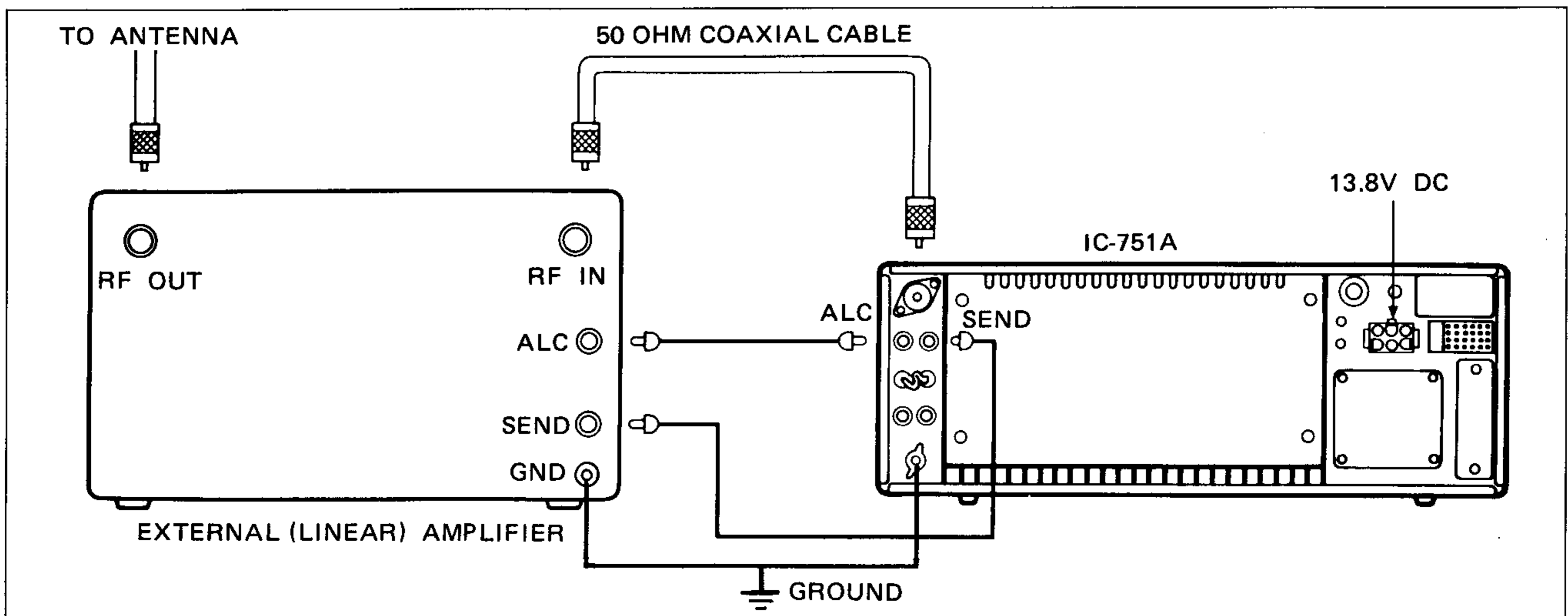

**5-3 ANTENNA TUNER**

It is recommended that the ICOM IC-AT100 or IC-AT500 Automatic Antenna Tuner be used between the IC-751A and the antenna system to achieve maximum performance from the transceiver.

The IC-751A may also be used with the AH-2 Automatic Antenna Tuner (weatherproofed) designed especially for long wire or vertical antennas. The AH-2 covers all HF bands therefore it is suitable for use on the Amateur bands as well as with the IC-751A general coverage receiver.

**● USING THE IC-AT100 or IC-AT500**

The maximum allowable input for the IC-AT100 is 100 watts, therefore, the IC-AT500 must be used with the IC-2KL Linear Amplifier.

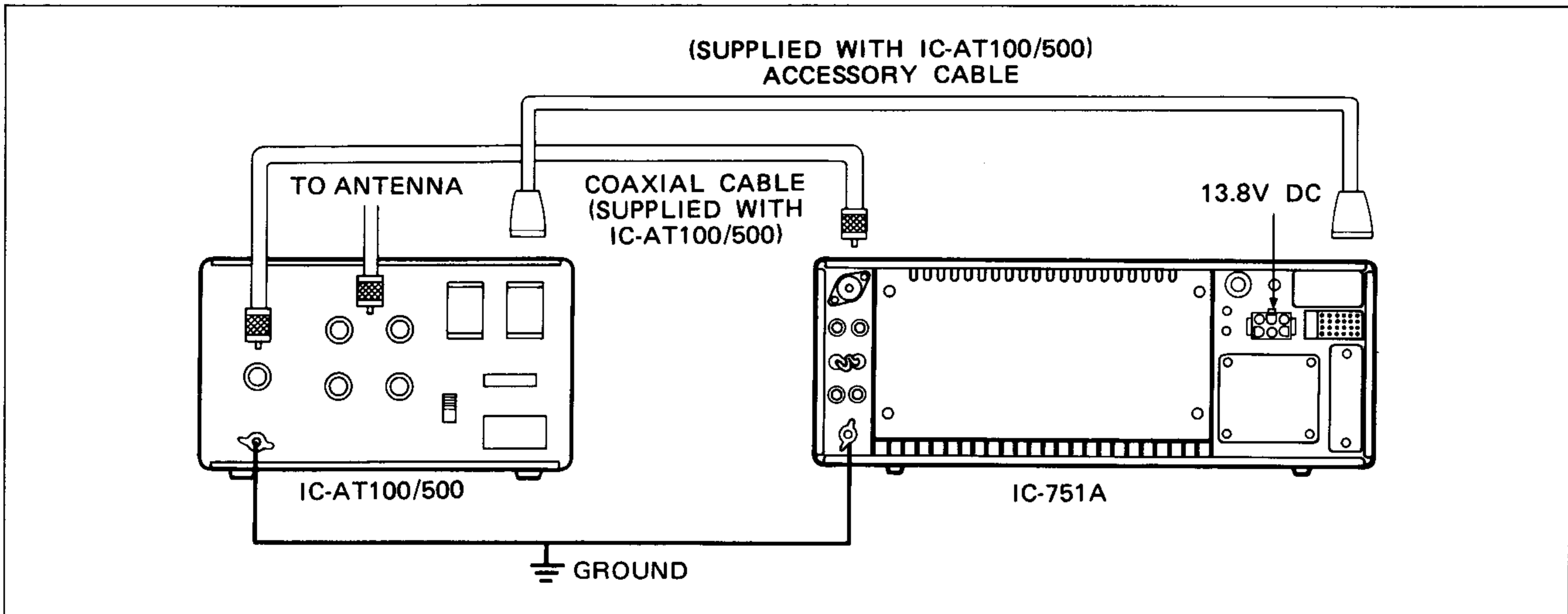

**● USING THE AH-2**

The AH-2 provides reliable matching for frequencies from 1.8MHz to 30MHz using a 12 meter long antenna element.

**NOTE:** It is necessary to adjust the tuning power. Refer to the AH-2 manual, SECTION 5 - 3 TUNING POWER.

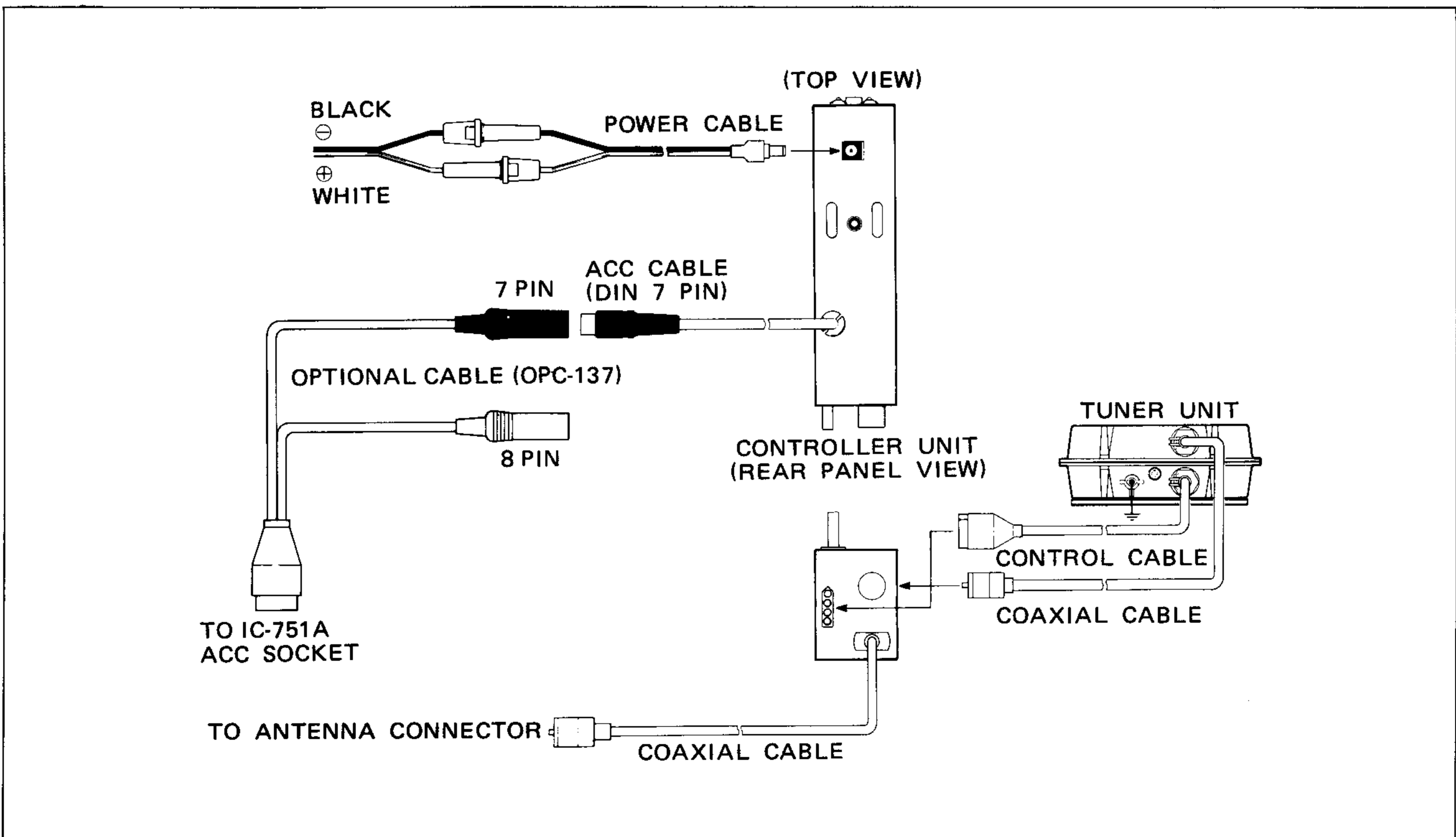

## 5-4 RTTY TERMINAL UNIT

When operating RTTY, connect the ACC CONNECTOR pin 9 and pin 8 (ground) via a high speed relay or through a level converter for conversion to TTL level to your teletypewriter. The audio tones for your terminal are available from pin 4 and pin 8 (ground). The AF output level is about 300mVp-p for an S9 signal.

### • USING A HIGH SPEED RELAY

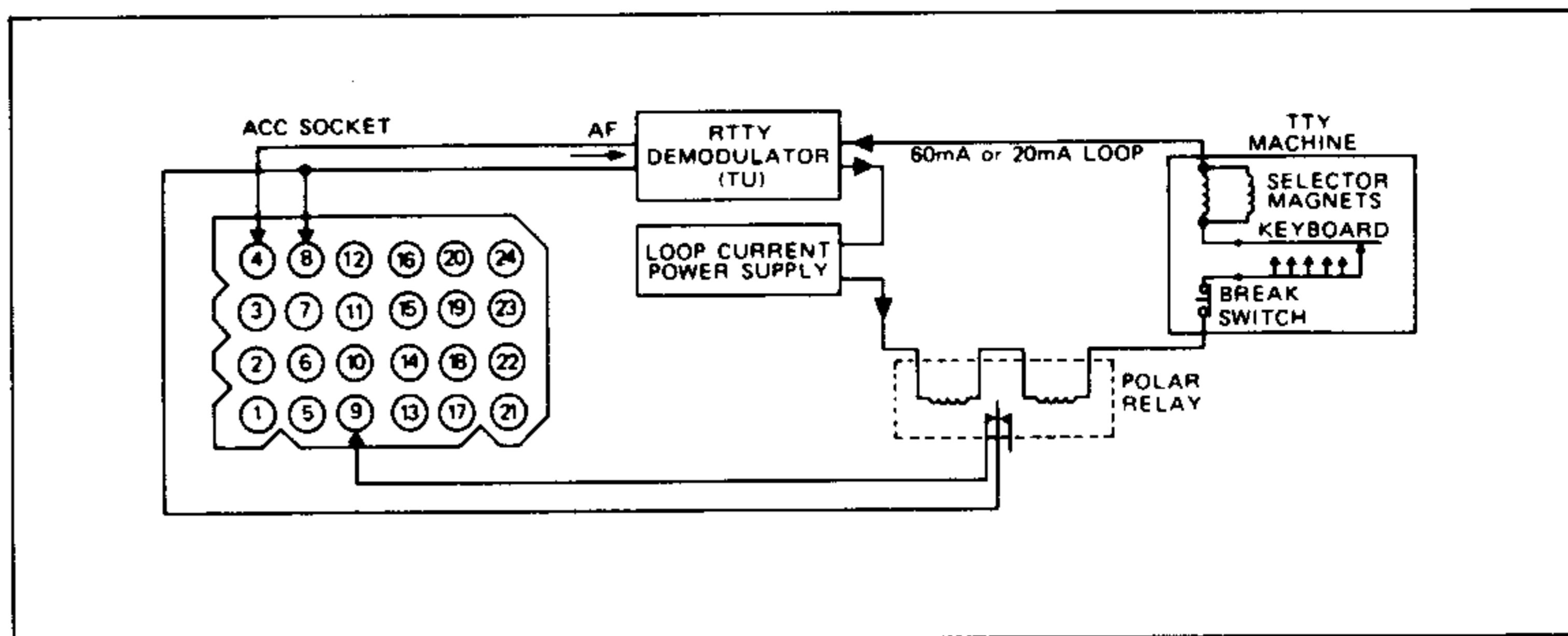

### • USING A LEVEL CONVERTER

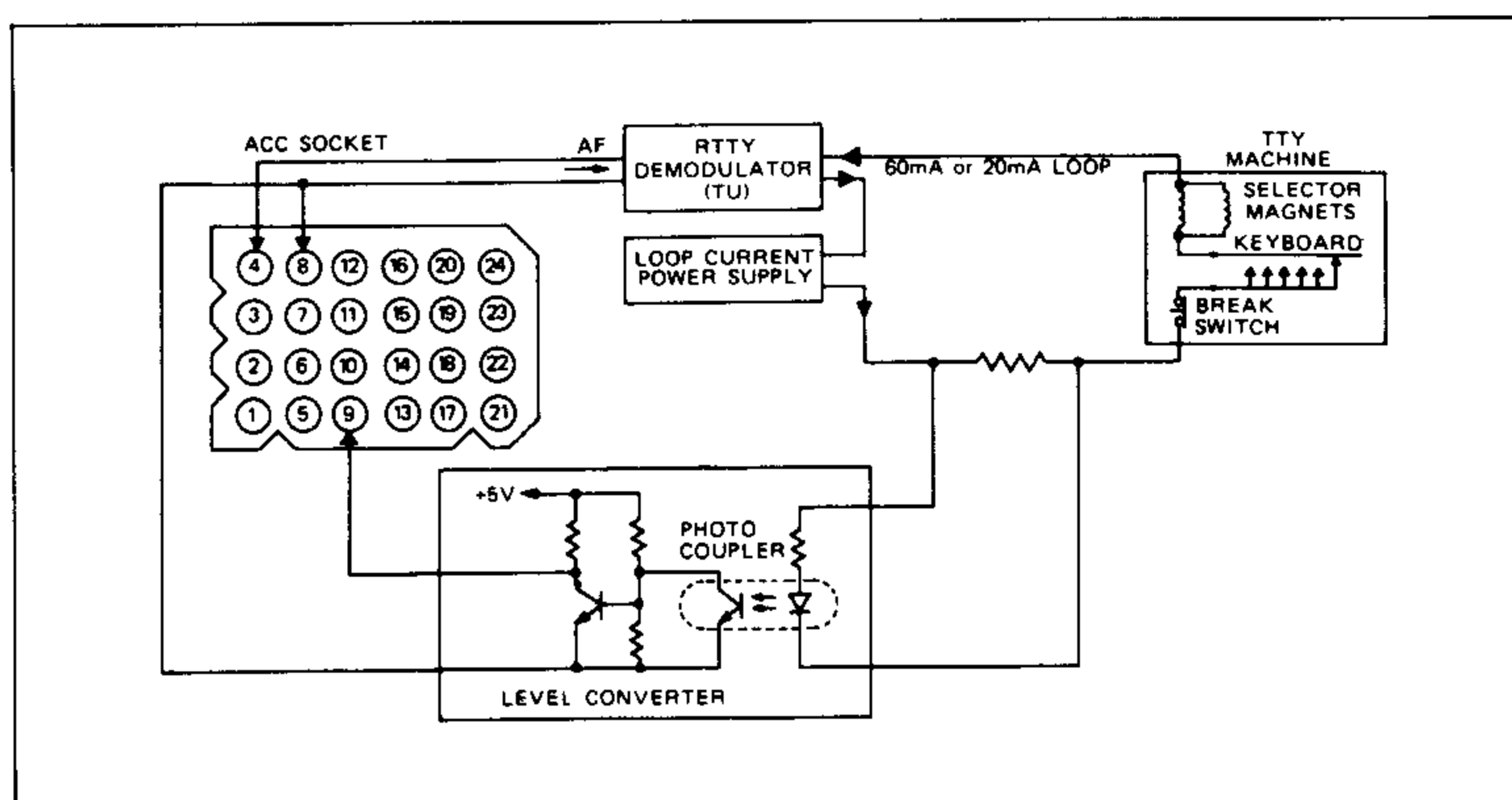

### • USING AN AFSK GENERATOR

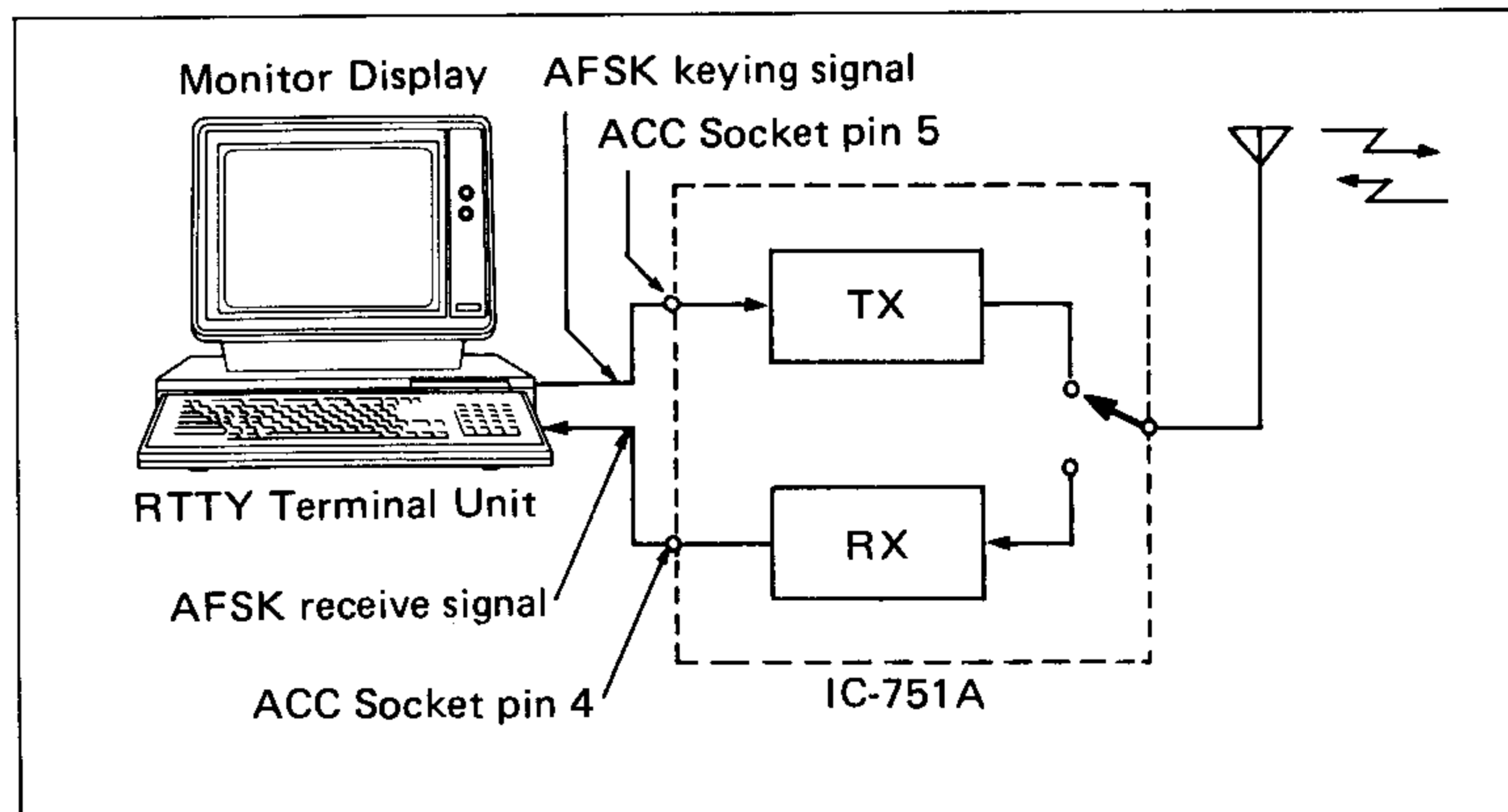

- An RTTY Terminal Unit for AFSK operation can also be connected easily.

**NOTE:** Some RTTY Terminal Units may require the use of a 20dB audio preamplifier between pin 5 on the ACC SOCKET and the AFSK signal output from the Terminal Unit to provide enough drive for full RF output power from the transceiver. The pin 5 input must be approximately 150mV rms.

Check your RTTY Terminal Unit Instruction Manual.

- The AFSK signal may be connected to the IC-751A front panel MIC CONNECTOR pin 1 instead of the ACC CONNECTOR if the Terminal Unit output is not high enough. An extra stage of amplification is provided in the transceiver when using the microphone connector.

## 5 - 5 SSTV UNIT

Slow Scan Television operation is also possible with the IC-751A.

- Connect the CAMERA OUTPUT on your SSTV Unit to the ACC CONNECTOR pin 5 or MIC CONNECTOR pin 1.
- The audio output signal (300mVp-p) is available from pin 4 and the ground is pin 8.

## 5 - 6 ACCESSORY SOCKET CONNECTIONS

Various signals are available from the accessory socket such as modulation output, receiver output, T/R changeover, etc.

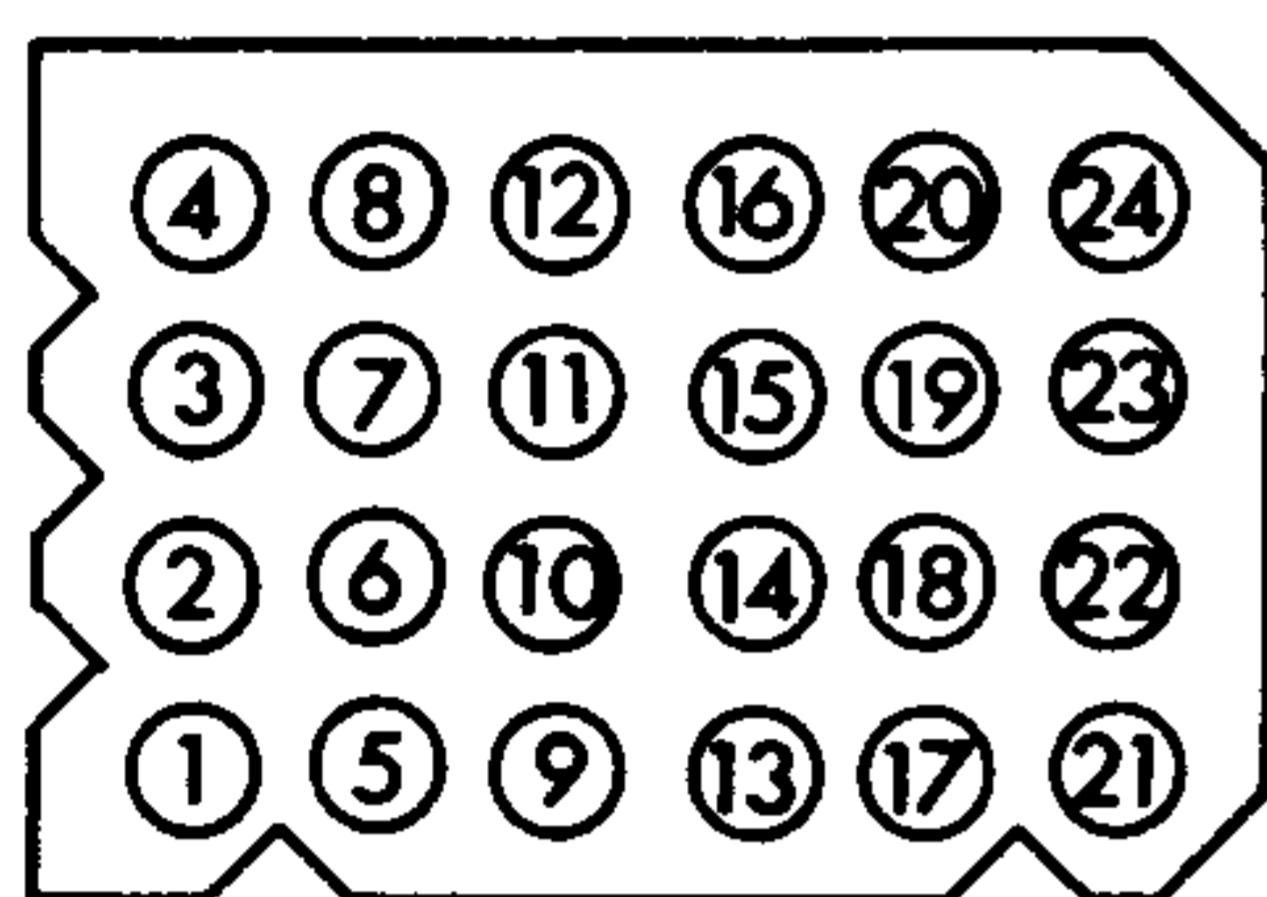

Outside view

PIN NO.	FUNCTION
1	Output from the squelch control stage. (+8V when the squelch is ON.)
2	13.8 volts DC interlocked with the power switch.
3	Connected to the push-to-talk, T/R switch. When grounded, the transceiver changes to the transmit mode.
4	Output from the receive detector stage. Fixed output regardless of AF output or AF gain.
5	Output from the transmit MIC amplifier stage. (Input for the MIC gain control stage.)
6	8 volts DC output while transmitting. (Maximum output current is 5mA.)
7	Input for external ALC voltage.
8	Ground.
9	Input for RTTY keying (MARK: HIGH level, SPACE: LOW level). The levels for MARK and SPACE may be reversed with an internal switch.
10	NC (no connection).
11	Input for TRANSVERTER control. Apply 8 volts DC to use a transverter with the IC-751A.
12	Reference voltage output for band switching.
13	Band Control Voltage output. See below.
14 ~ 24	NC (no connection).

### •BAND CONTROL VOLTAGE

**NOTE:** The IC-751A outputs a band control voltage when the band of operation is changed. This signal automatically switches accessory equipment such as the ICOM linear amplifier or antenna tuners.

BAND (MHz)	BAND CONTROL VOLTAGE
1.8	7.0 ~ 8.0V
3.5	6.0 ~ 6.5V
7	5.0 ~ 5.5V
14	4.0 ~ 4.5V
18, 21	3.0 ~ 3.5V
24, 28	2.0 ~ 2.5V
10	0 ~ 1.2V

## SECTION 6 GENERAL OPERATION

### 6 - 1 SETTINGS

After all INSTALLATION instructions have been followed in SECTION 4, including connecting a 50 ohm antenna system, set the controls and switches as indicated below.

- 1) If a supply other than the IC-PS35, IC-PS30 or IC-PS15 is used, check that the AC power supply output voltage is 13.8 volts DC.
- 2) Check that the antenna connector on the feedline from the antenna is securely fastened to the ANTENNA CONNECTOR on the rear panel of the IC-751A.
- 3) Check all connections between the IC-751A and accessory equipment.

#### ●SWITCH AND CONTROL SETTINGS

SWITCH/CONTROL	POSITION
POWER	OFF (OUT)
AF GAIN	MAXIMUM COUNTERCLOCKWISE
RF GAIN	MAXIMUM CLOCKWISE
SQUELCH	MAXIMUM COUNTERCLOCKWISE
TONE	CENTER
MIC GAIN	CENTER
RF POWER	MAXIMUM CLOCKWISE
DIAL LOCK	OFF (OUT)
PBT	CENTER
NOTCH	CONTROL: CENTER SWITCH : OFF
FILTER	OFF (OUT)
TS	OFF (INDICATOR OFF)
DFS	OFF (INDICATOR OFF)
BAND	OFF (INDICATOR OFF)
VOX	OFF (OUT)
COMP	OFF (OUT)
NB WIDE	OFF (OUT)
VOX GAIN	OFF
VOX DELAY	FULL
NB LEVEL	OFF
AGC	SLOW
METER	Ic
TRANSMIT/RECEIVE	RECEIVE
SPLIT	OFF (OUT)

### 6 - 2 BASIC OPERATION

This section explains basic receiving and transmitting methods. Refer to SECTIONS 6 - 3 through 6 - 8 for detailed explanations of each operating mode.

Before beginning, confirm all switches and controls are set as stated in SECTION 6 - 1 SETTINGS.

#### ●RECEIVING

- 1) Power ON.

- 1) Push the POWER SWITCH to turn ON the transceiver. The FREQUENCY DISPLAY lights after about 2 seconds and the transceiver is ready for receiving.

2) Select MODE.

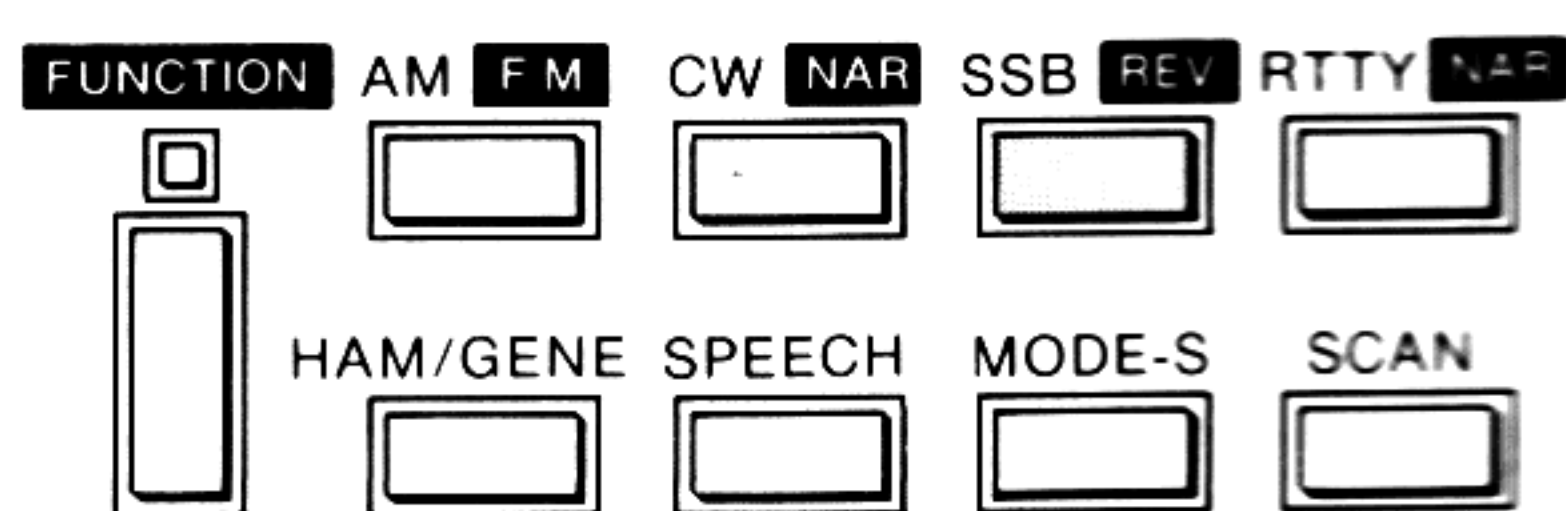

3) Select BAND.

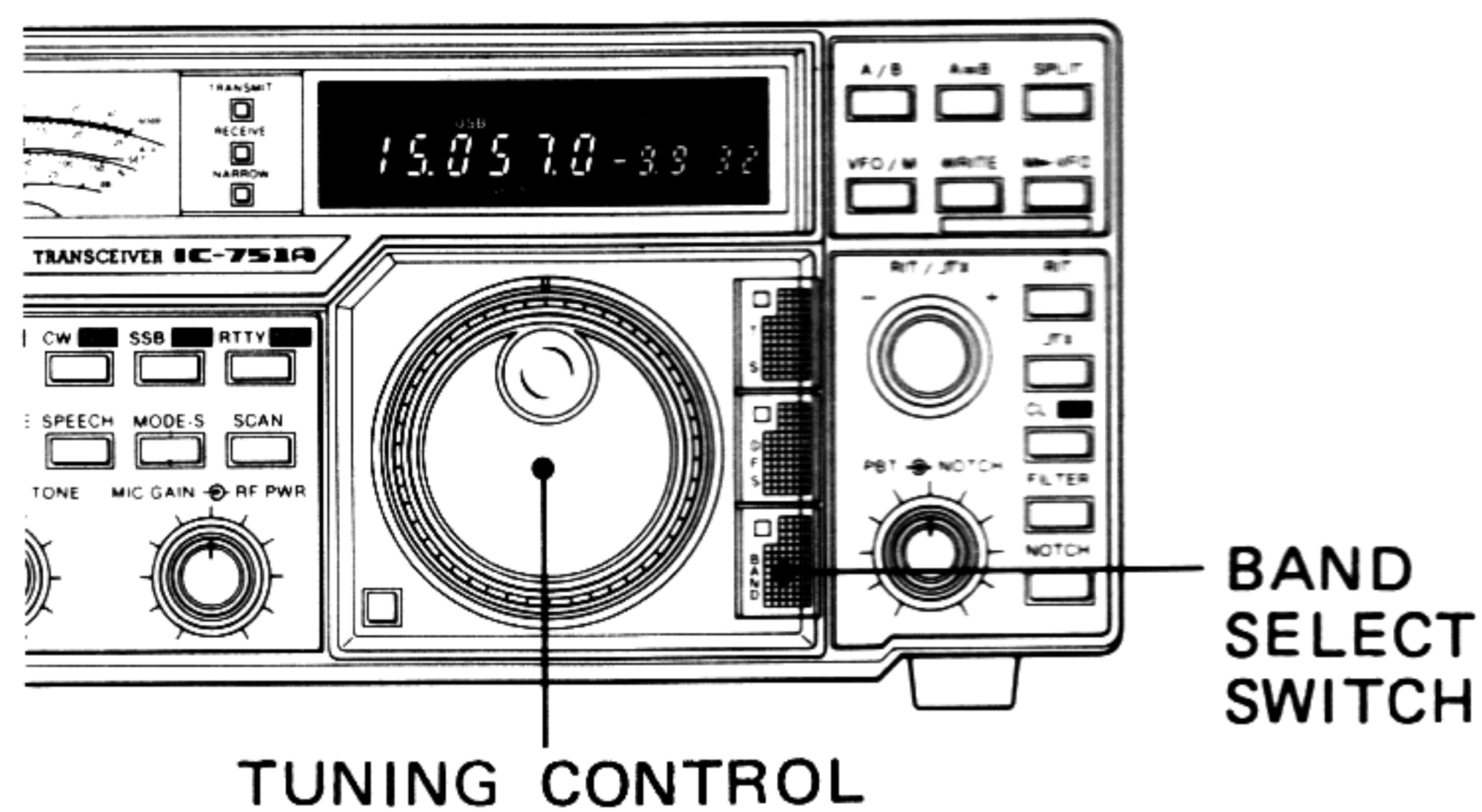

4) Adjust AF GAIN CONTROL.

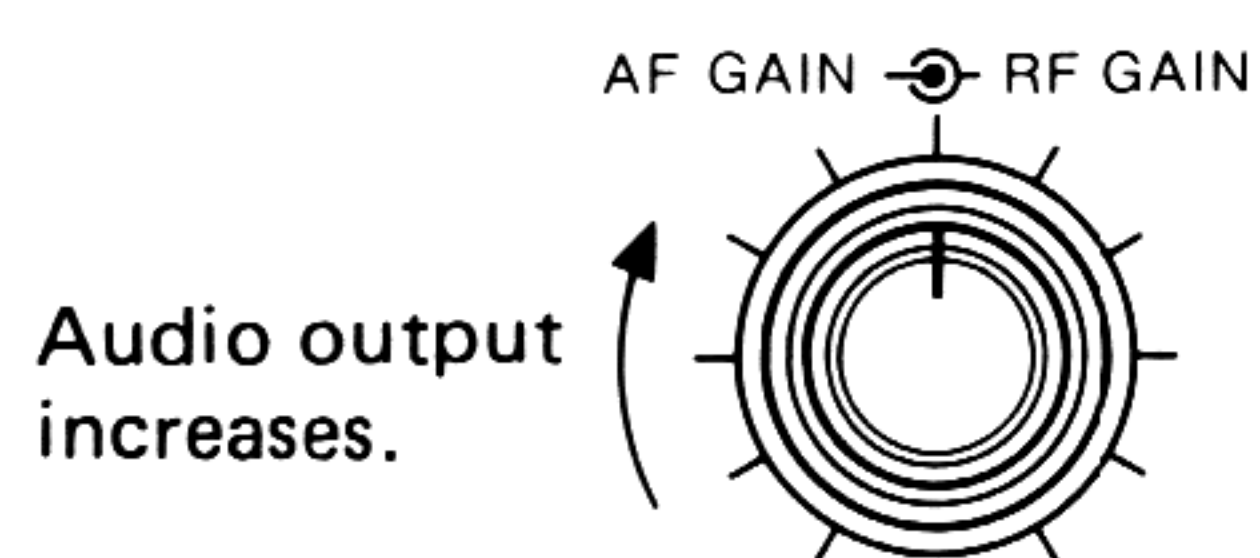

5) Rotate TUNING CONTROL

## ● TRANSMITTING

Red LED lights when transmitting.

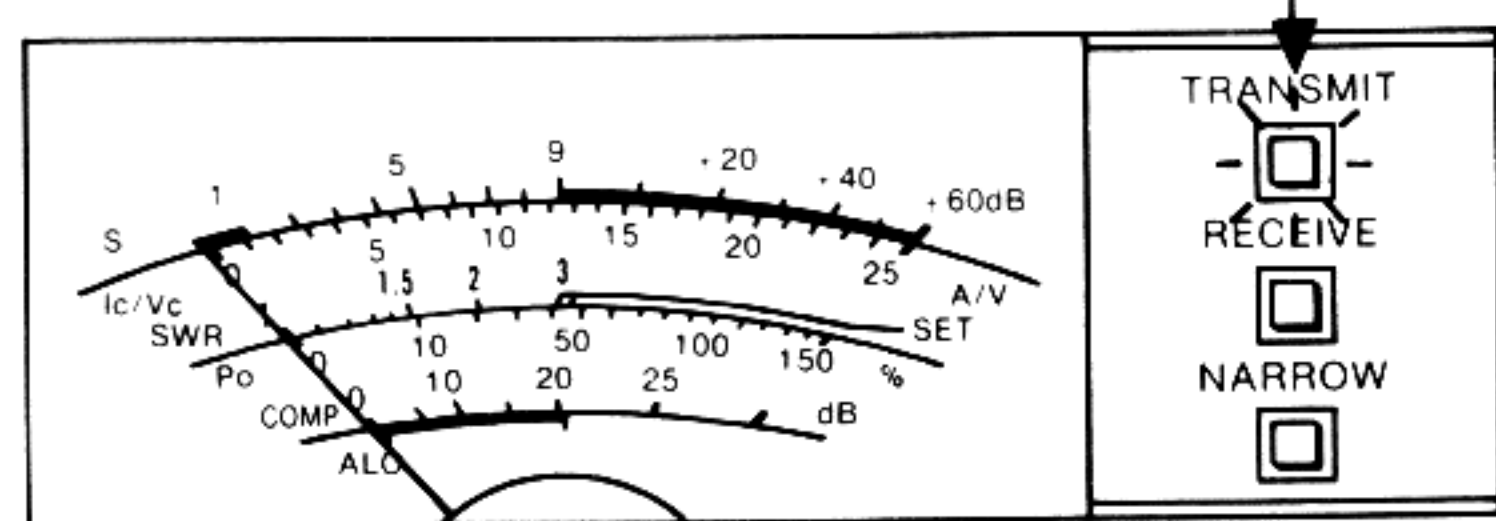

## ● FREQUENCY SELECTION

2) Push the SSB SWITCH to select the SSB mode.

3) Push the BAND SELECT SWITCH. The BAND SELECT INDICATOR lights. Rotate the TUNING CONTROL to select the 14MHz band. (Note: Only the "MHz" digits change as the TUNING CONTROL is turned.)

4) Rotate the AF GAIN CONTROL clockwise for a comfortable receive level.

The green RECEIVE INDICATOR should be lit. If not, check the position of the SQUELCH CONTROL (maximum counterclockwise).

5) Rotate the TUNING CONTROL until a signal is received. Tune for the highest S-METER reading and the clearest audio. (Note: The wrong mode may be selected if the signal is not understandable.)

Before transmitting, listen in the receive mode to make sure your transmission will not interfere with other communications.

First, set the switches and controls as stated in SECTIONS 6 - 1 SETTINGS and RECEIVING above.

1) Push the PTT SWITCH on the microphone or switch the TRANSMIT/RECEIVE SWITCH to TRANSMIT. The red TRANSMIT LED lights.

2) Speak into the microphone, and note that the meter needle follows the modulation of your voice. You are now transmitting SSB signals.

3) If you wish to increase the output power, rotate the RF POWER CONTROL for the desired power between 10 and 100 watts.

The IC-751A transmitter covers all HF Amateur bands exclusively. In addition, the receiver covers all frequencies from 0.1 to 30MHz continuously.

1) TUNING CONTROL:

Rotate the TUNING CONTROL clockwise to increase the frequency, and counterclockwise to decrease the frequency in 10Hz steps while in any operating mode. Turning the TUNING CONTROL faster automatically shifts the tuning increments to 50Hz.

2) TUNING SPEED SWITCH [TS]:

When the TUNING SPEED function is ON, the operating frequency shifts in 1kHz increments while in any operating mode as the TUNING CONTROL is turned.

**NOTE:** The IC-751A transmits in the ranges shown in the table, however it is the operator's responsibility to follow the pertinent government radio regulations.

BAND (MHz)	FREQUENCY COVERAGE (MHz)
1.8	1.800.0 ~ 2.000.0
3.5	3.450.0 ~ 4.100.0
7	6.950.0 ~ 7.500.0
10	9.950.0 ~ 10.500.0
14	13.950.0 ~ 14.500.0
18	17.950.0 ~ 18.500.0
21	20.950.0 ~ 21.510.0
24.5	24.450.0 ~ 25.100.0
28/29	27.950.0 ~ 30.000.0

BAND (MHz)	HAM BAND INITIALIZATION FREQUENCIES*
1.8	1.900.0MHz
3.5	3.550.0MHz
7	7.050.0MHz
10	10.047.0MHz
14	14.047.0MHz
18	18.047.0MHz
21	21.047.0MHz
24.5	24.547.0MHz
28/29	28.047.0MHz

\* SSB mode selected.

## ● MODE SELECTION

### 1) AM



### 2) FM

Push FUNCTION and AM SWITCHES.

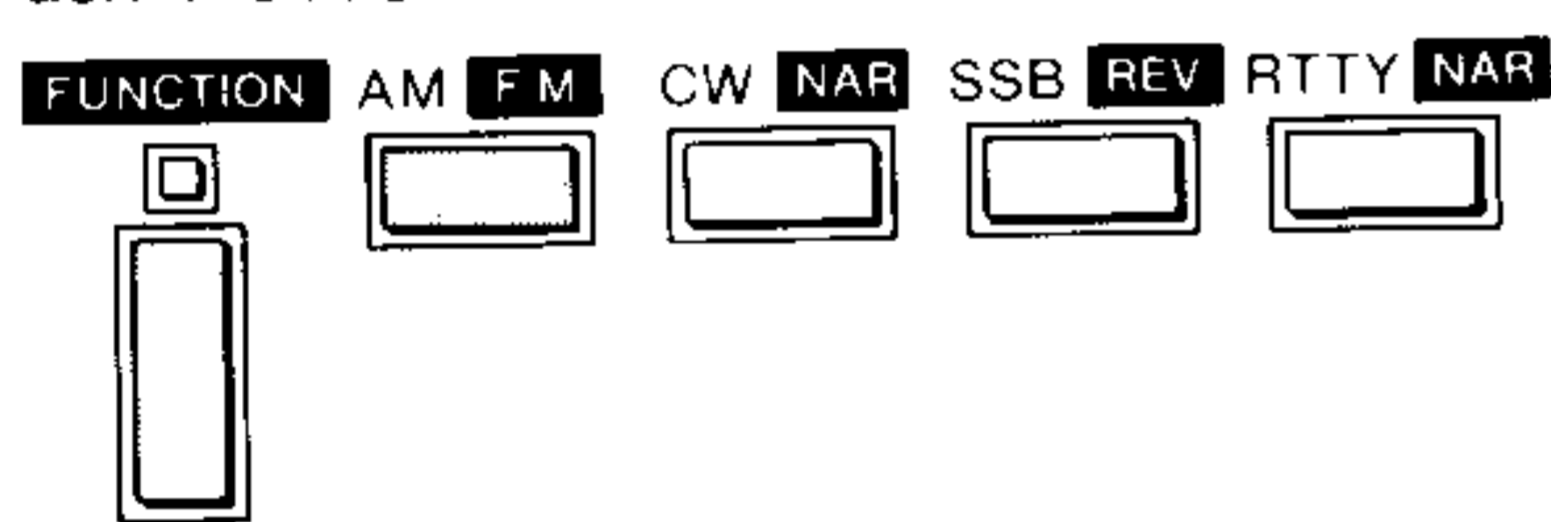

### 3) CW

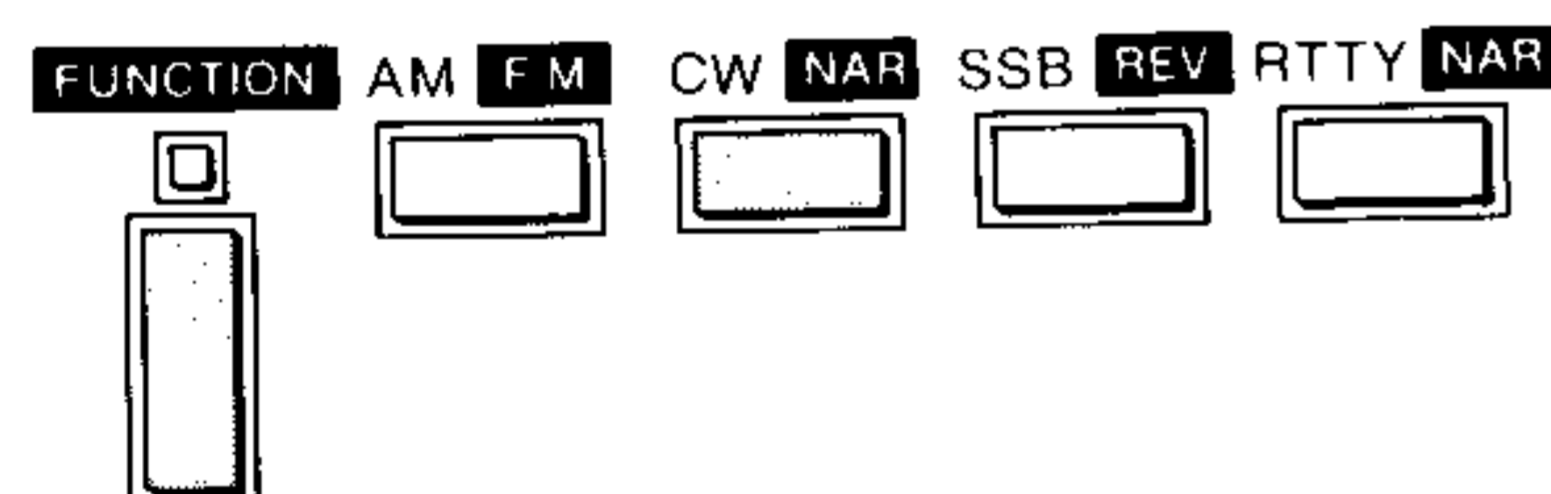

### 4) SSB [USB/LSB]

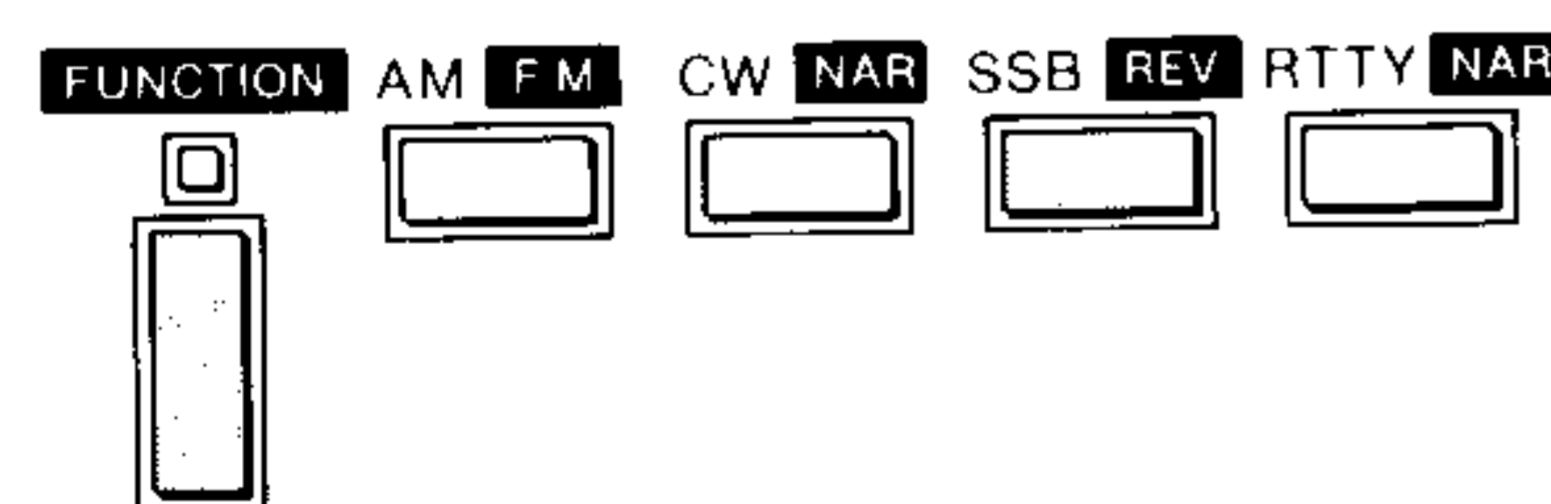

### 5) RTTY

Push RTTY SWITCH.

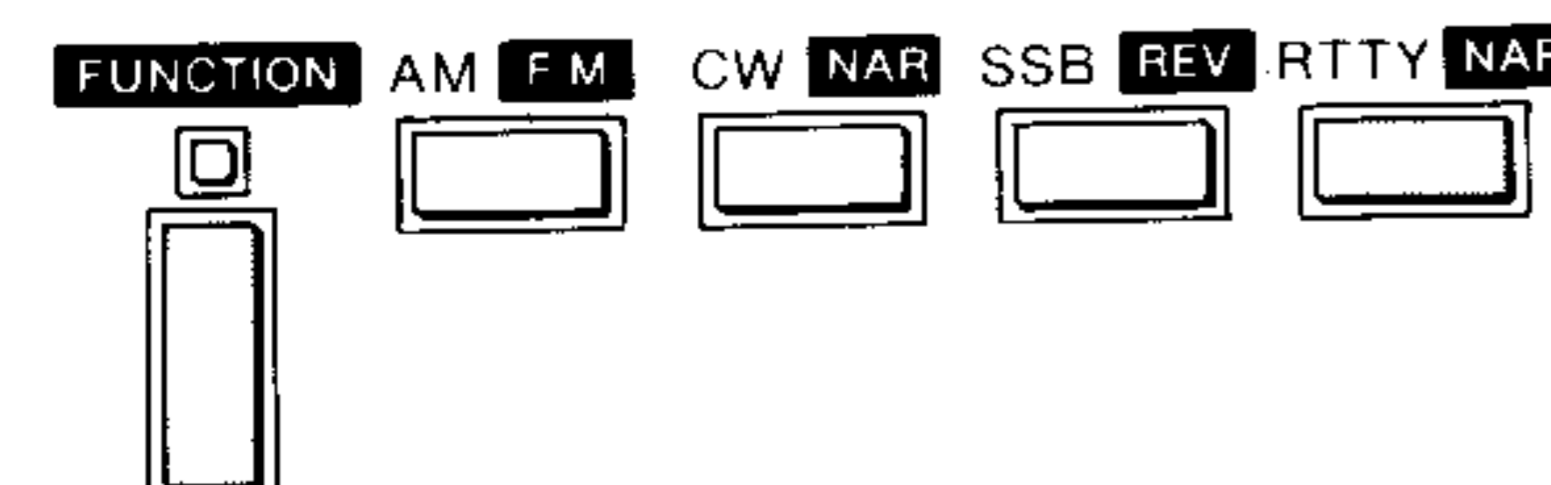

### 3) BAND SELECT SWITCH [BAND]:

Push this switch IN and rotate the TUNING CONTROL to change the operating band. When in the HAM BAND mode, the VFO frequencies selected on each band are the initialization frequencies as shown in the chart. In the GENERAL COVERAGE mode, only the 10 and 1 MHz digits of the display change.

The various modes are selected by using the MODE SWITCHES in conjunction with the FUNCTION SWITCH.

Push the AM SWITCH to select the AM mode.

Refer to SECTION 6 - 5 for AM operation.

Push the FUNCTION SWITCH, then the FM SWITCH to select the FM mode. Pushing the AM/FM SWITCH again returns the transceiver to the AM mode.

Refer to SECTION 6 - 6 for FM operation.

Push the CW SWITCH to select the CW mode, or push the FUNCTION SWITCH then the CW SWITCH to select the CW NARROW mode. The optional FL-52A or FL-53A narrow filter is required to use the CW NARROW mode.

Refer to SECTION 6 - 4 for CW operation.

Push the SSB SWITCH to automatically select the USB mode on the 10MHz band and above, and the LSB mode on the 7MHz band and below. Push the FUNCTION SWITCH, then the SSB SWITCH to select the opposite mode.

Refer to SECTION 6 - 3 for SSB operation.

**NOTE:** See SECTION 6 - 8, step 4) for USB/LSB selection when operating in the GENERAL COVERAGE mode.

Push the RTTY SWITCH to select the RTTY mode, or push the FUNCTION SWITCH then the RTTY SWITCH to select the RTTY NARROW mode. The optional FL-52A or FL-53A narrow filter is required to use the RTTY NARROW mode.

Refer to SECTION 6 - 7 for RTTY operation.



●VFO A/B SELECTION

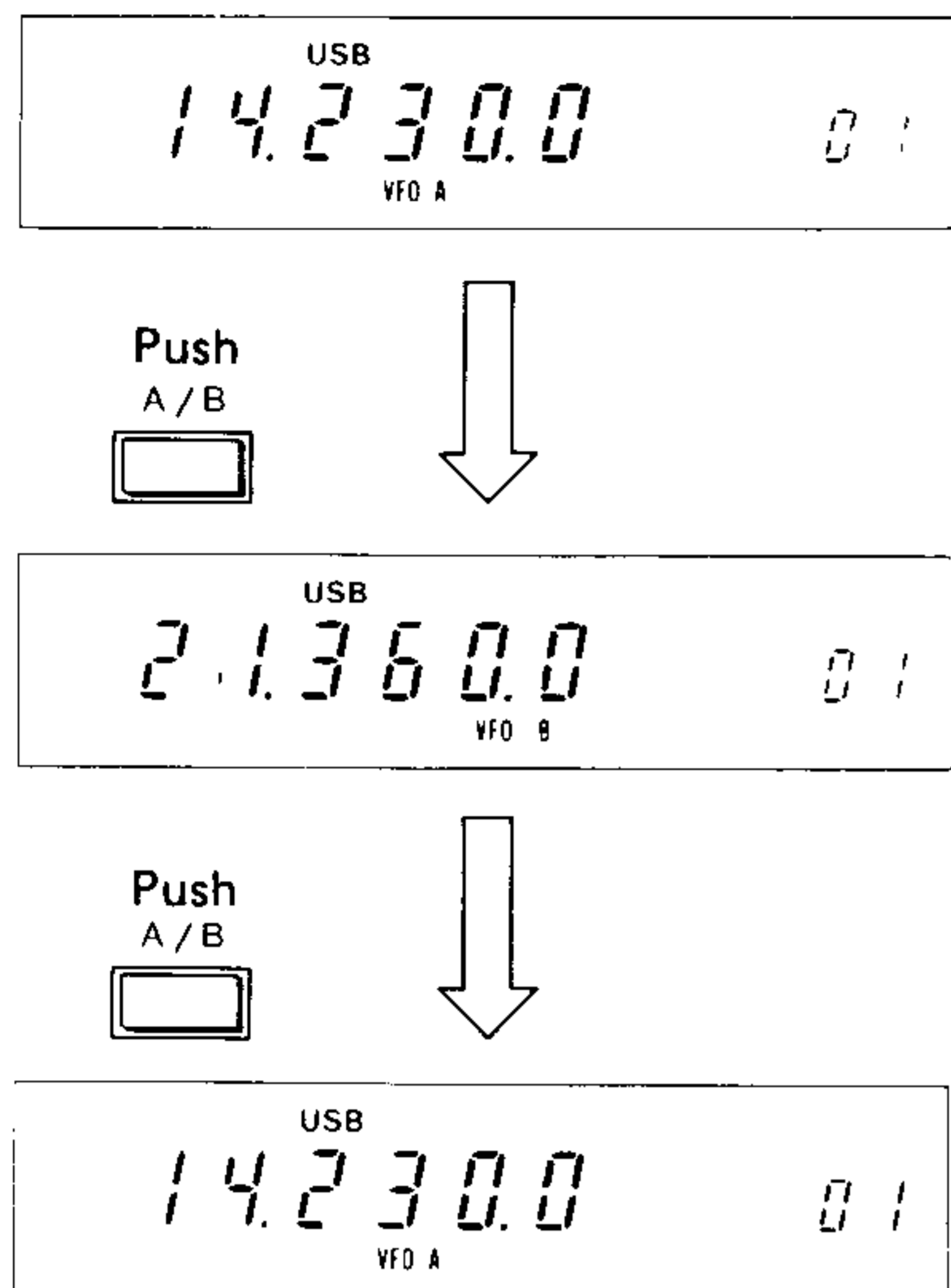

The IC-751A contains two VFOs for receiving and transmitting. Push the A/B SWITCH to select VFO A or VFO B alternately when in the VFO mode. This dual VFO system provides a great deal of operating flexibility.

- When VFO A is selected, "VFO A" lights on the display and both transmit and receive frequencies are as indicated on the frequency display. This frequency and the mode are stored in the VFO A memory.

- When VFO B is selected, "VFO B" lights on the display and both transmit and receive frequencies are as indicated on the frequency display. This frequency and the mode are stored in the VFO B memory.

- 1) Select the frequency 14.230.0MHz and USB using VFO A. Push the VFO A/B SWITCH, and the display shows the frequency and mode that is stored in VFO B. The frequency 14.230.0MHz and USB are still stored in VFO A, however.

- 2) Push the VFO A/B SWITCH again and the display shows the VFO A information. Each time the switch is pushed, the alternate VFO is selected.

Switching from one VFO to the other VFO does not clear the VFO memories.

●VFO MODE/MEMORY MODE

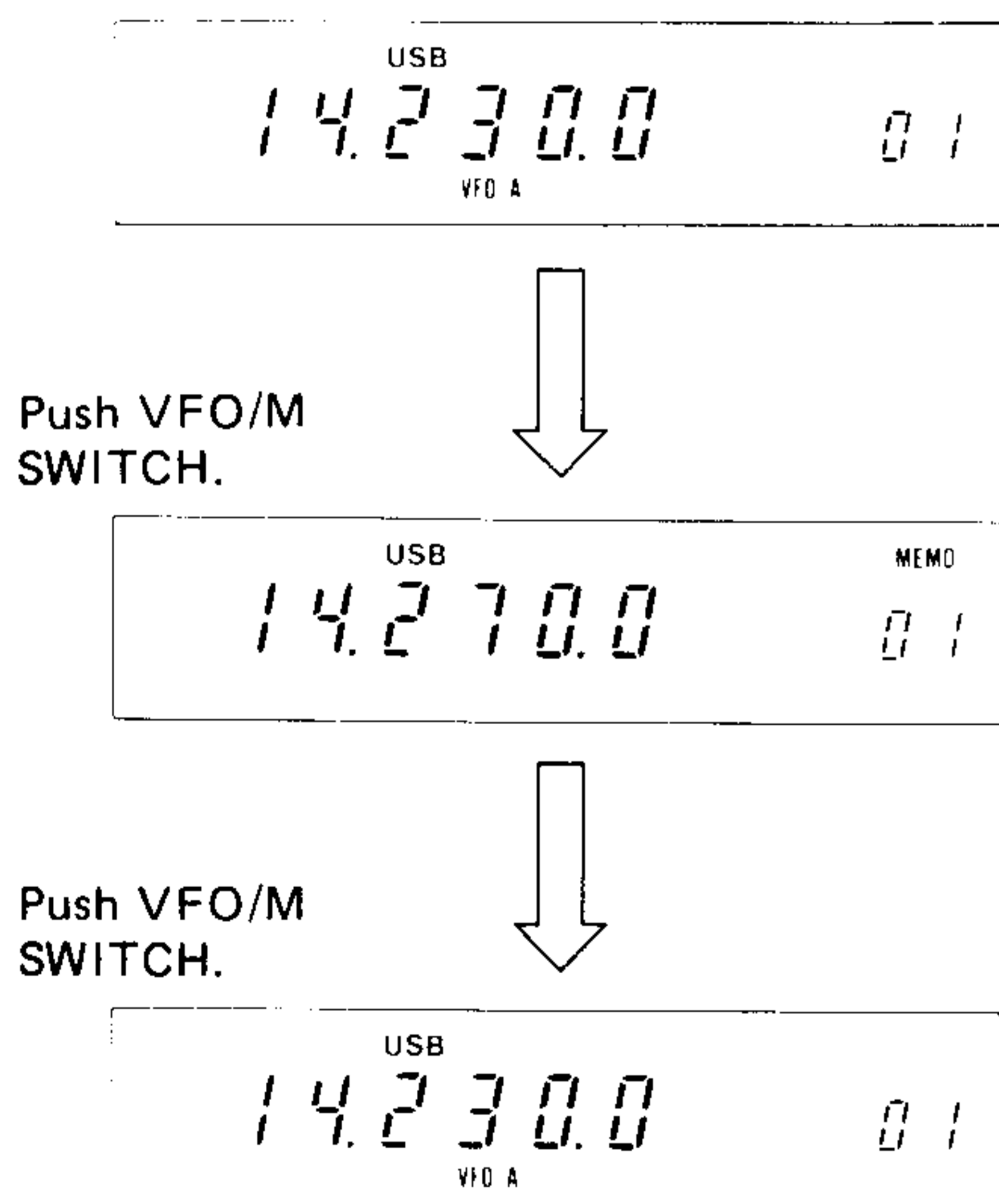

Push the VFO/MEMORY [VFO/M] SWITCH to change the IC-751A from the VFO mode to the MEMORY CHANNEL mode or vice versa. When in the MEMORY CHANNEL mode, any of the frequencies stored in the 32 memory channels may be selected and used.

●OTHER FUNCTIONS

Detailed descriptions for the other functions available on the radio are given in later sections.

6 - 3 SSB OPERATION

(1) SSB RECEIVING

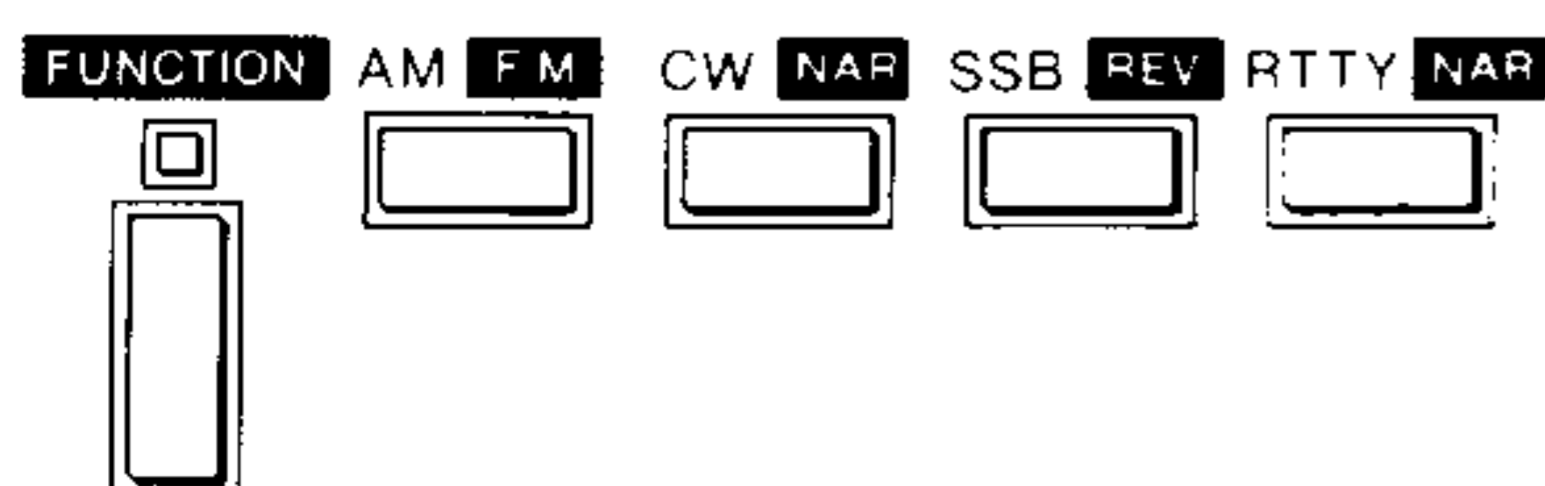

- 1) Set all controls and switches as described in SECTION 6 - 1.

- 2) Push IN the POWER SWITCH.

- 3) Push the BAND SELECT SWITCH and rotate the TUNING CONTROL to select the desired band of operation. Push the BAND SELECT SWITCH again to disable the band select function.

## (2) SSB TRANSMITTING

**NOTE:** Listen carefully before transmitting to be sure your transmission will not interfere with any other communications.

### •VOX OPERATION

### •SPEECH COMPRESSOR OPERATION

### •USING THE MONITOR FUNCTION

- 4) Adjust the AF GAIN CONTROL for the desired volume.
- 5) Rotate the TUNING CONTROL and search for a signal. Tune across the signal to peak the meter needle while listening for the most intelligible audio.
- 1) Select the transmit mode using either the T/R SWITCH or the PTT SWITCH.
- 2) Set the METER SWITCH to the Po position. Speak into the microphone in a normal voice. The meter movement indicates that a signal is being transmitted.
- 3) The TRANSMIT INDICATOR lights whenever the IC-751A is placed in the transmit mode, however an RF signal is only transmitted when the selected operating frequency is within an Amateur band.
- 4) Set the METER SWITCH to the ALC position, and adjust the MIC GAIN for a meter reading within the ALC zone on voice peaks.

Refer to SECTION 7 - 1.

Refer to SECTION 7 - 2.

The transmitted signal can be monitored when using the SSB mode if desired. This is useful to check the audio quality of your output, particularly important when using the speech compressor.

- 1) Set the MONITOR/MARKER SWITCH on the top panel to MONITOR.
- 2) Adjust the MONITOR LEVEL CONTROL on the top panel to a comfortable audio level.

It is preferable to use headphones to prevent "howling" caused by feedback from the speaker to the microphone.

## 6 - 4 CW OPERATION

### (1) CW RECEIVING

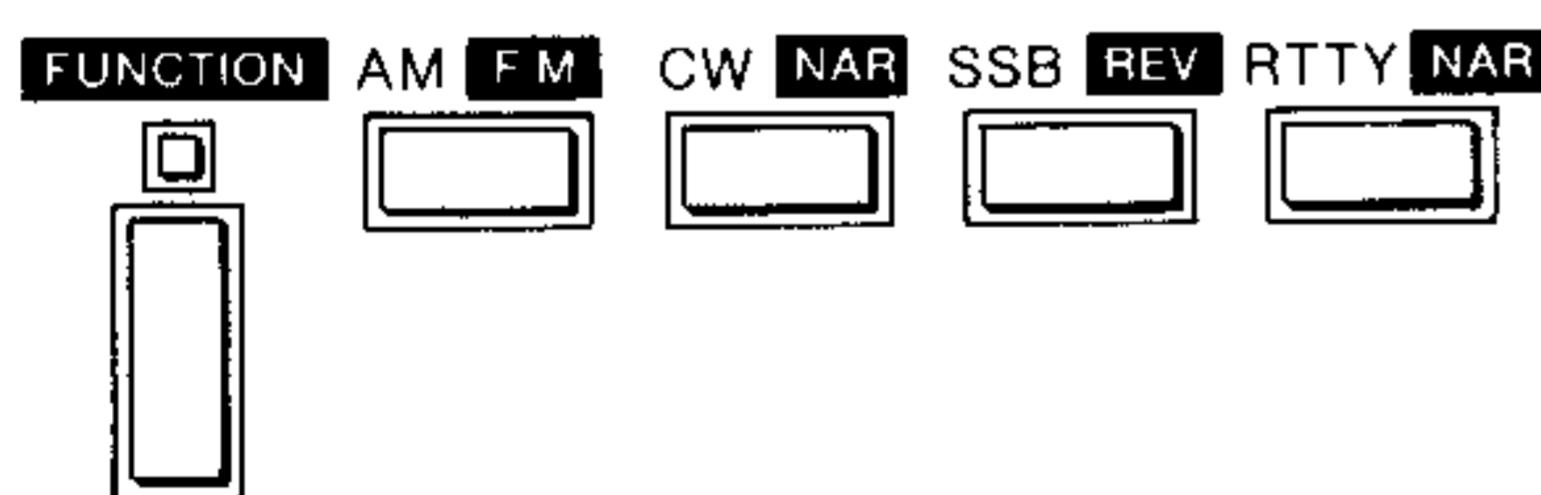

For CW reception, select the CW or CW NARROW mode. Audio output from the speaker is muted when the CW NARROW mode is selected with no optional narrow filter installed. Other switches and controls are set the same as for SSB reception.

- 1) Push the POWER SWITCH to turn ON the power.
- 2) Push the CW SWITCH.
- 3) Set the desired operating frequency.
- 4) Adjust the AF GAIN CONTROL for a suitable volume.
- 5) When the FILTER SWITCH is pushed IN, the passband tuning system may be used to set the receiver selectivity to 700Hz by tuning the PBT CONTROL to the maximum counterclockwise or clockwise position, or to 2.3kHz by placing the control at the detent. Additionally, the notch filter eliminates specific interference at discrete frequencies within the passband of the receiver.

Refer to SECTIONS 7 - 7 and 7 - 8 for passband and notch filter operation.

**(2) CW NARROW RECEIVING**

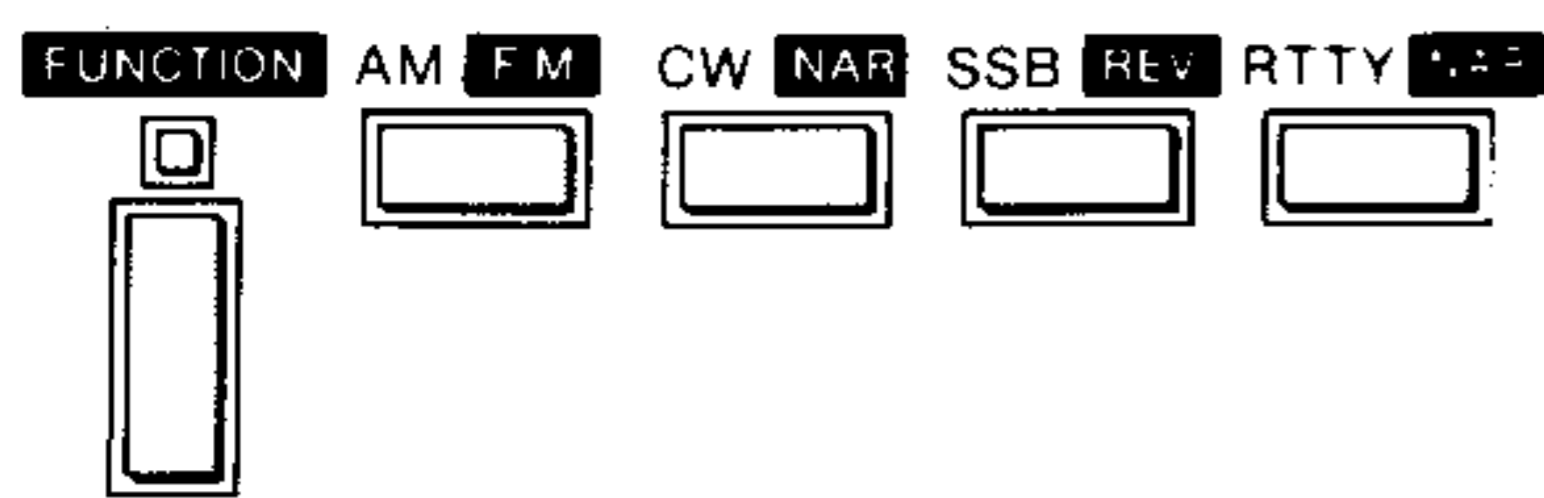

The IC-751A has already FL-32A (500Hz/−6dB) filter installed. If an optional narrow filter is installed, push the FUNCTION SWITCH, then the CW SWITCH to select the narrow filter thereby improving the receiver selectivity with higher shape factor.

Background noise is reduced and the signal-to-noise ratio (S/N) is improved with the narrow filter for more enjoyable listening conditions.

**●OPTIONAL FILTERS**

1) The chart shows the optional filters available.

FILTER	CENTER FREQUENCY	CHARACTERISTICS (BANDWIDTH)	
		−6dB	−60dB
FL-52A	455kHz	500Hz	1.0kHz
FL-53A	455kHz	250Hz	480Hz

2) Push the FUNCTION SWITCH, then the CW SWITCH to select the CW NARROW mode. The CW NARROW INDICATOR lights when the function is activated.

3) Once the CW NARROW mode is selected, follow the instructions in the CW RECEIVING section.

**(3) CW TRANSMITTING**

1) Insert the CW key plug into the KEY JACK on the rear panel of the IC-751A.

2) Set the switches and controls as shown in the chart.

**NOTE:** See SECTION 4 - 5 CW KEY for CW key connections.

SWITCH/CONTROL	POSITION
RF POWER	MAX. CLOCKWISE
METER	P <sub>0</sub>
VOX GAIN	OFF (MAX. COUNTERCLOCKWISE)

3) Select the transmit mode with the T/R SWITCH.

4) Operate the CW key. The meter movement indicates that a signal is being transmitted.

**●CW SIDETONE MONITOR**

An 700Hz sidetone oscillator is provided to monitor keying when in the CW mode. The MONITOR LEVEL CONTROL varies the volume of the tone. This control is located on the top panel of the transceiver.

- Rotate the MONITOR LEVEL CONTROL clockwise to increase the volume of the oscillator tone. The transceiver AF GAIN CONTROL also varies the volume.

**●BREAK-IN OPERATION**

Refer to SECTION 7 - 4 for semi or full break-in CW operation.

**6 - 5 AM OPERATION**

**(1) AM RECEIVING**

Set all controls as stated in SECTION 6 - 1 SETTINGS.

1) Push IN the POWER SWITCH.

2) Select the desired band of operation.

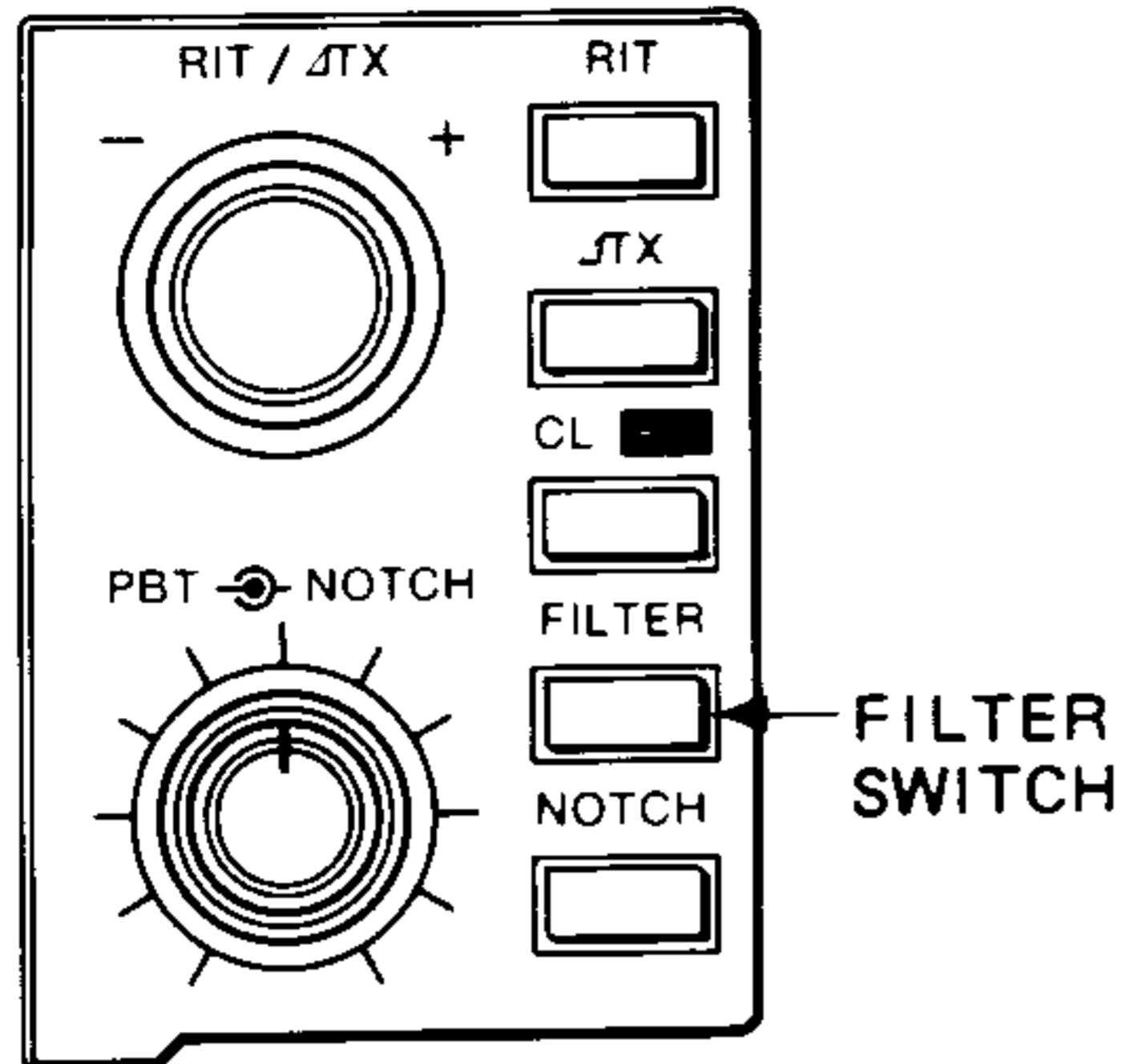

## (2) AM TRANSMITTING

- 3) Push the AM SWITCH.
- 4) Tune in an AM signal with the TUNING CONTROL using the meter to peak the signal.
- 5) Push the FILTER SWITCH to select the narrow receive selectivity.

FILTER SWITCH	BANDWIDTH
ON (IN)	3kHz
OFF (OUT)	8kHz

**NOTE:** The PBT CONTROL (passband tuning) has no effect in the AM mode.

- 6) Refer to SECTION 10 - 1 for installation instructions for the optional FL-33 crystal filter.

Transmitting an AM signal is essentially the same as for SSB transmission.

- 1) Select the transmit mode with either the T/R SWITCH or the PTT SWITCH on the microphone.
- 2) Turn the RF POWER CONTROL maximum clockwise or set it to obtain the desired power output.
- 3) Set the METER SWITCH to the Po position.
- 4) Adjust the MIC GAIN CONTROL for a slight indication of the meter needle while speaking into the microphone in a normal voice.

**NOTE:** MIC GAIN CONTROL settings which are too high result in overmodulation and a distorted signal. Set the MIC GAIN carefully.

- 5) The speech compressor (COMP SWITCH) should be turned OFF to prevent overmodulation or distortion.
- 6) Use the FILTER SWITCH to select the widest selectivity position.

## 6 - 6 FM OPERATION

### (1) FM RECEIVING

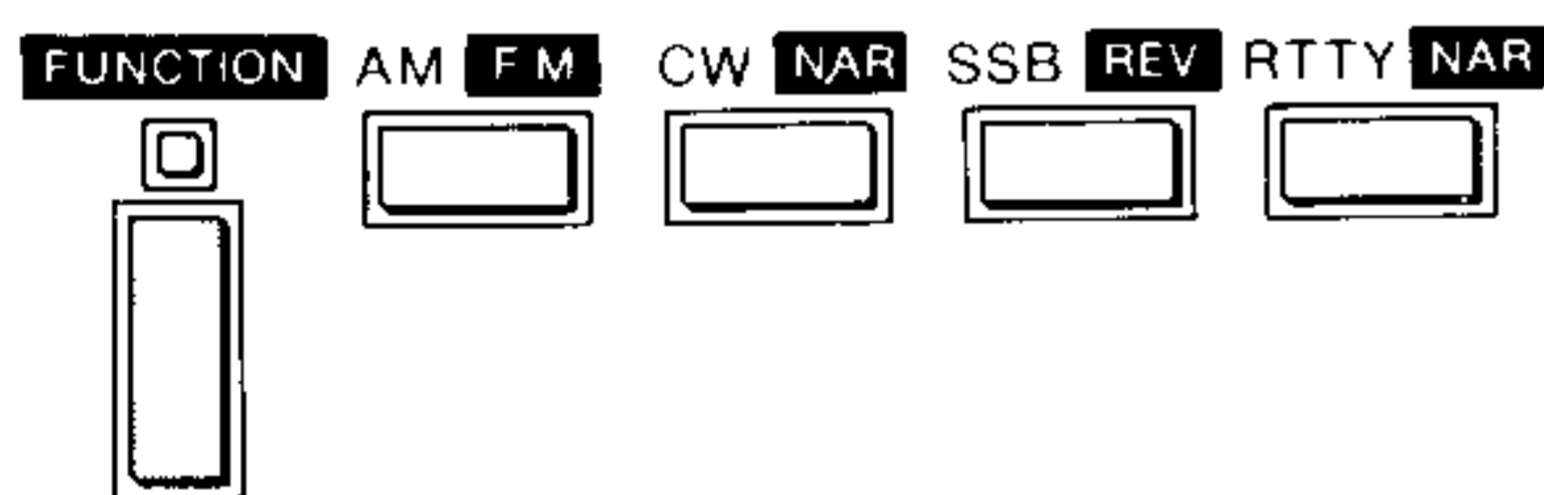

- 1) Push the FUNCTION SWITCH, then the FM SWITCH.
- 2) Set the other switches and controls the same as for SSB reception.

The PBT CONTROL, NOTCH SWITCH and CONTROL, NOISE BLANKER SWITCH and CONTROL, AGC SWITCH and FILTER SWITCH do not function in this mode.

- 3) When tuning an FM signal, tune for maximum signal strength as indicated on the meter with the clearest audio.

### ●SQUELCH FUNCTION

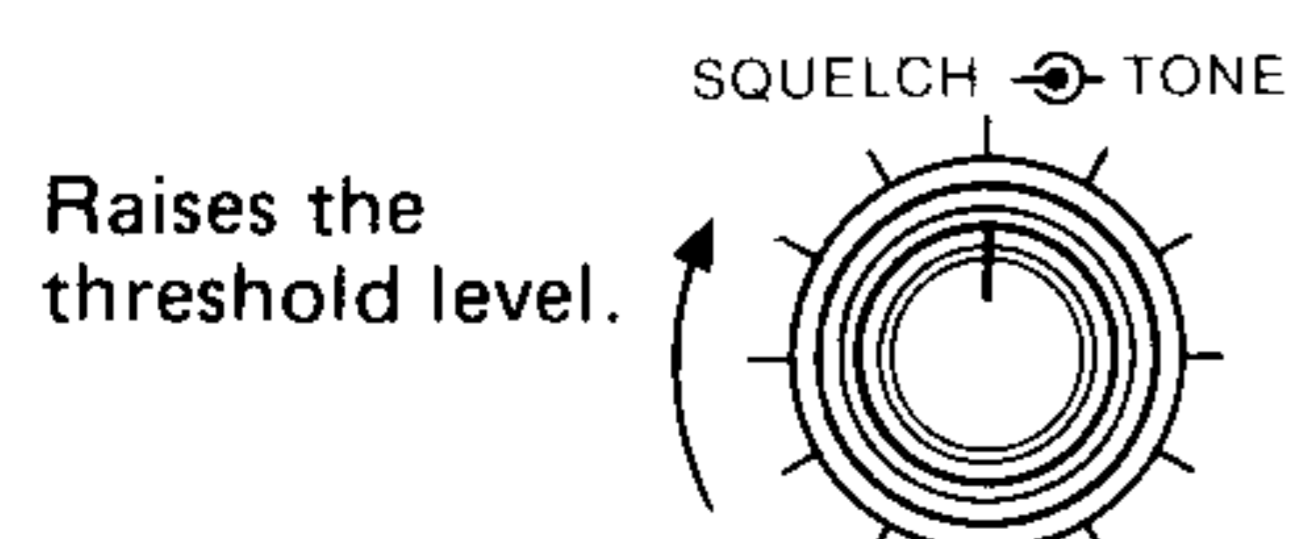

**SQUELCH:** If closed, the squelch mutes all noise from the speaker when no signal is received. This is useful while waiting for another station to call.

## (2) FM TRANSMITTING

Transmitting an FM signal is essentially the same as for SSB transmission.

- 1) Set the MIC GAIN CONTROL to the center position.
- 2) Select the transmit mode with either the T/R SWITCH or the PTT SWITCH on the microphone.
- 3) Speak into the microphone in a normal voice. The meter needle indicates the carrier power when the METER SWITCH is in the Po position, however the meter does not move in time with your voice modulation in this mode.

**NOTE:** Most countries only allow FM operation on 28MHz or higher.

## (3) FM REPEATER OPERATION

**NOTE:** The UT-30 was preset with an 88.5Hz tone. Change the UT-30 programming if a different frequency is required.

An 88.5Hz TONE ENCODER is often required to access HF FM repeaters. The optional UT-30 PROGRAMMABLE TONE ENCODER is designed for this purpose.

Install the encoder in the location shown in SECTION 10 OPTIONS INSTALLATION. Connect the 3-pin connector from the encoder onto J6 ("TONE" jack) on the MAIN unit.

- 1) When operating through repeaters, program the transmit and receive frequencies in VFO A and VFO B.

Refer to SECTION 6 - 2 VFO A/B SELECTION for information on using the two VFOs.

- 2) The encoder tone is transmitted when the FUNCTION SWITCH is pushed while transmitting. In addition, the FUNCTION INDICATOR lights.

**NOTE:** The FUNCTION INDICATOR lights when the FUNCTION SWITCH is pushed while transmitting even if the UT-30 is not installed, however no tone is transmitted.

## 6 - 7 RTTY OPERATION

For RTTY operation, a teletypewriter or keyboard and a demodulator (terminal unit) which is operational with audio input are required.

Any demodulator designed for 170Hz narrow shift with 2125/2295Hz filters may be used with the IC-751A.

### (1) RTTY UNIT CONNECTIONS

Refer to SECTION 5 - 4 RTTY TERMINAL UNIT for system interconnections and further information.

### (2) RTTY RECEIVING

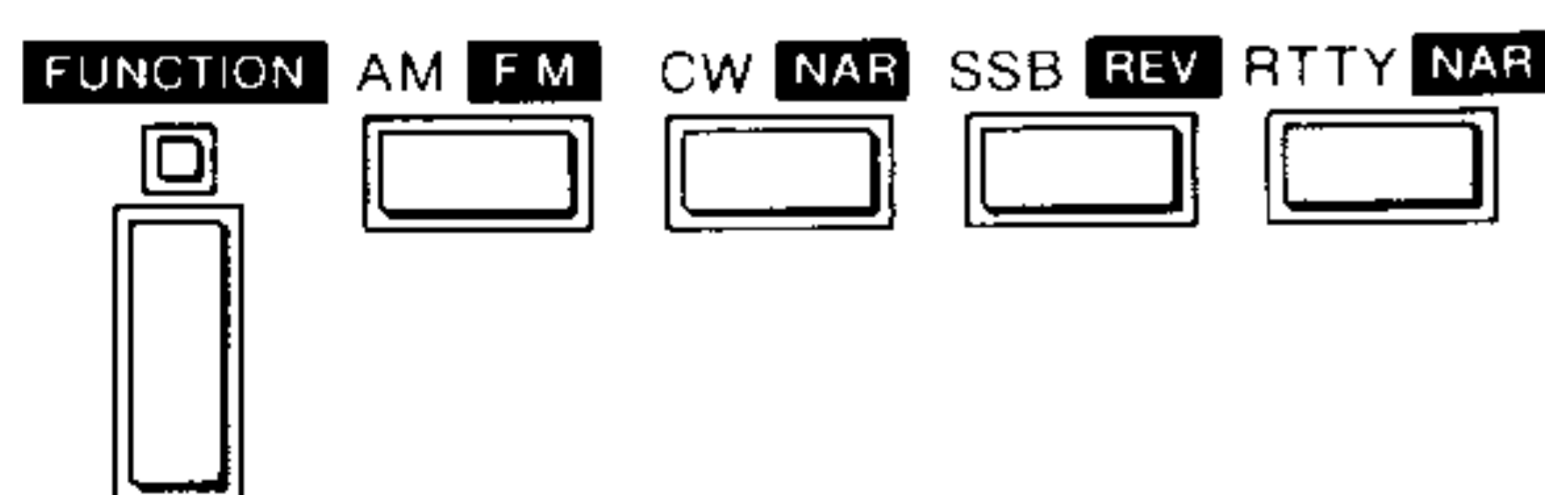

Audio signals for the demodulator may be taken from pin 4 of the ACC SOCKET on the rear panel of the IC-751A, or from the PHONES JACK on the front panel. The level of the audio signals from the ACC SOCKET does not vary when adjusting the AF GAIN CONTROL, and the level is about 300mVp-p maximum.

- 1) Push the RTTY SWITCH to select the RTTY operating mode.
- 2) Set the other controls and switches the same as for SSB reception.

- 3) Tune in an RTTY signal using the tuning indicator of the terminal unit or the cross pattern of an oscilloscope to center the receiver on the signal. Mark frequency is 2125Hz and space frequency is 2295Hz.

Adjust the PBT CONTROL as required for the best reception.

- 4) If an optional narrow CW filter is installed, push the FUNCTION SWITCH, then the RTTY SWITCH to select the narrow filter. The receiver selectivity will be narrowed.

#### ●OPTIONAL FILTERS

FILTER	CENTER FREQUENCY	CHARACTERISTICS (BANDWIDTH)	
		-6dB	-60dB
FL-52A	455kHz	500Hz	1.0kHz
FL-53A	455kHz	250Hz	480Hz

- 5) To tune RTTY signals with a wider shift, such as 425Hz or 850Hz, obtain a demodulator suitable for the desired shift and use the normal RTTY mode.

#### (3) RTTY TRANSMITTING

- 1) To key the FSK circuit, insert a high speed relay coil into the loop current circuit of the teletypewriter, and connect the relay contacts to pins 8 and 9 of the ACC SOCKET on the rear panel.
- 2) The relay contacts make during the SPACE and break during the MARK.
- 3) Fine adjustment of the MARK and SPACE frequencies can be made by adjusting the trimmer capacitors in the MAIN unit. Refer to SECTION 13 - 4 ADJUSTMENT LOCATIONS.

#### ●USING A LEVEL CONVERTER

- 1) When a level converter for TTL levels is used, connect the output of the converter to pin 8 (ground) and pin 9 on the ACC SOCKET.
- 2) Apply HIGH level (5V) signals for MARK, and LOW level (0V) for SPACE.

If your equipment supplies reverse polarity signals (i.e., MARK: 0V, SPACE: 5V), slide S2 on the MAIN unit to the REVERSE position. See SECTION 13 - 4 ADJUSTMENT LOCATIONS for the S2 location.

#### ●USING AN AFSK GENERATOR

- 1) When using an AFSK generator with a 2125Hz MARK frequency and 2295Hz SPACE frequency, connect the output signals from the AFSK generator to the MIC CONNECTOR on the front panel or ACC socket on the rear panel.
- 2) Push the LSB SWITCH.
- 3) VOX T/R switching may be used while operating AFSK for easier operation.

#### 6 - 8 GENERAL COVERAGE RECEIVER

**NOTE:** When in the GENERAL COVERAGE mode, it is not possible to transmit on any frequency, including the Amateur band frequencies.

1) Set CONTROLS and SWITCHES.

2) Push IN POWER SWITCH.



3) Select GENERAL COVERAGE mode by pushing HAM/GENE SWITCH.



"GENE" lights.

**NOTE:** In the HAM BAND mode, the letters "GENE" do not light.

4) Push desired MODE SWITCH.

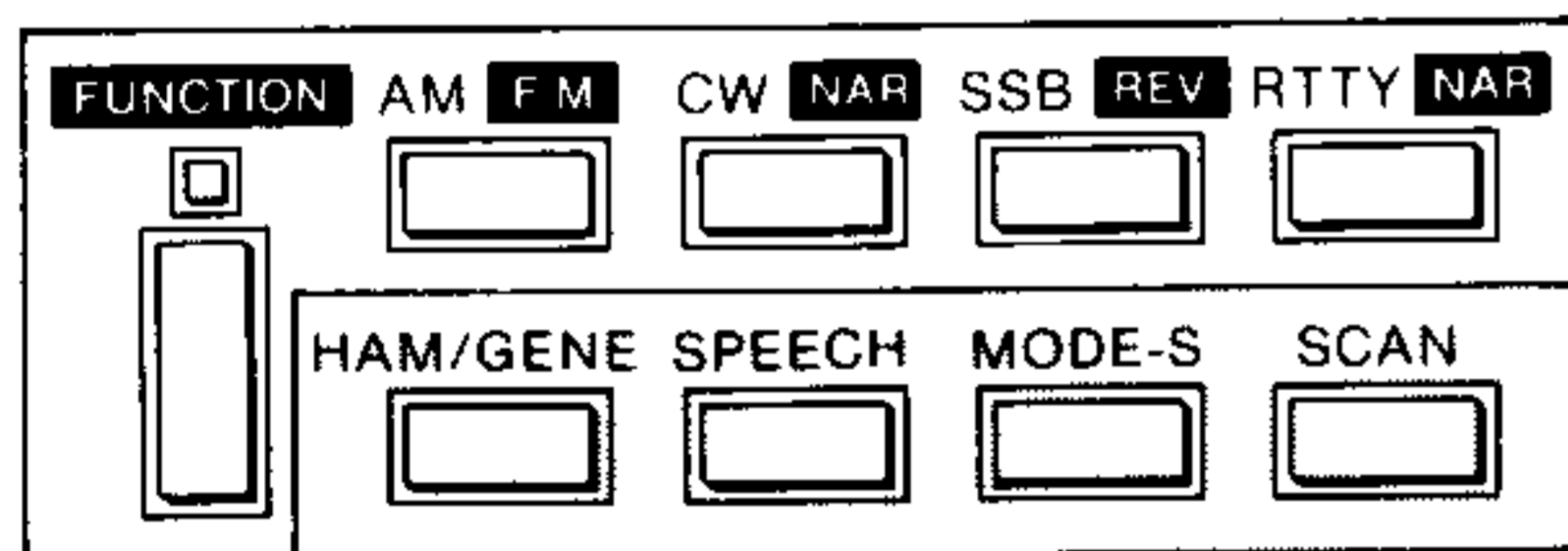

5) Select desired band and frequency.

6) Adjust AF GAIN CONTROL.

1) Set the CONTROLS and SWITCHES as stated in SECTION 6 - 1 SETTINGS. Other controls are unrelated to operation in this mode.

2) Push IN the POWER SWITCH.

The meter lamp lights, and shortly thereafter, the display lights and indicates the frequency and HAM/GENERAL mode which are stored in the VFO A memory. The memory channel number "01" also lights.

3) If the transceiver does not display "GENE", push the HAM/GENE SWITCH. The GENERAL COVERAGE mode is now selected. When the HAM BAND mode is selected, the "GENE" indicator goes out.

4) Push the desired MODE SWITCH. When the SSB mode is chosen, USB is automatically selected on the 10MHz band and above, and LSB is selected on the 9MHz band and below.

Note, however, once either USB or LSB mode is automatically selected, this mode is maintained regardless of frequency or band changes. To change to the opposite sideband, push the FUNCTION SWITCH, then the SSB SWITCH again.

5) Push the BAND SELECT SWITCH, then use the TUNING CONTROL to select the desired band of operation. Push and release the BAND SELECT SWITCH again, and tune the TUNING CONTROL until a signal is located.

6) Adjust the AF GAIN CONTROL for a comfortable audio level.

The multifunction meter indicates the signal strength of the received signal, therefore tune for the highest reading on the meter with the clearest audio.

Refer to SECTIONS 6 - 3 to 6 - 7 for further information on each mode.

## SECTION 7 FUNCTIONS OPERATION

### 7 - 1 VOX OPERATION

- 1) Set controls.

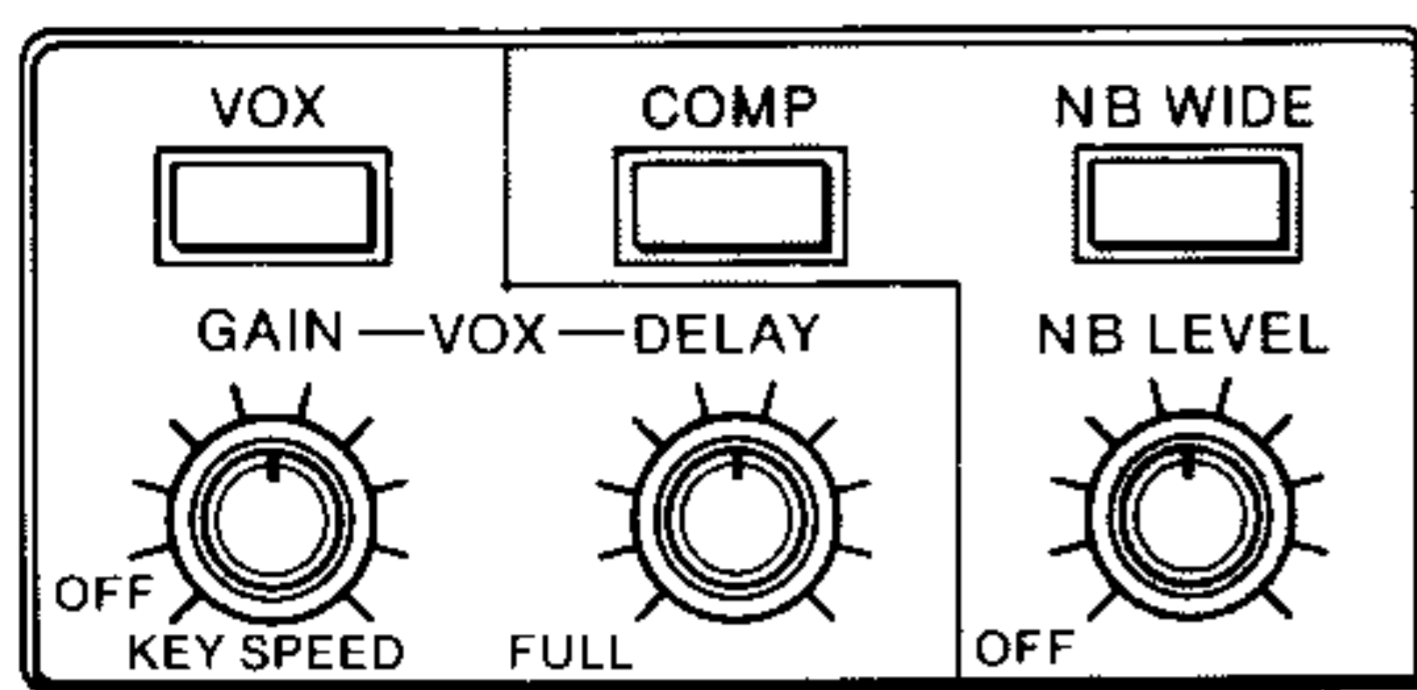

- 2) Set the T/R SWITCH in the receive position.

- 3) Adjust VOX GAIN CONTROL.

- 4) Adjust VOX DELAY CONTROL.

- 5) Adjust ANTI-VOX CONTROL.

### 7 - 2 SPEECH COMPRESSOR OPERATION

- 1) Set METER SWITCH to "COMP" position.

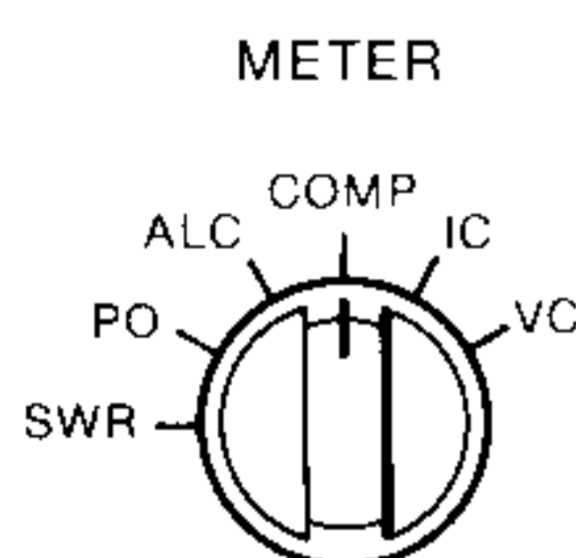

- 2) Switch to transmit and speak into the mic.

- 3) Adjust the MIC GAIN CONTROL.

- 4) **NOTE:** Misadjustment of the speech compressor may cause interference to other stations.

The IC-751A has a built-in VOX (voice-operated relay) circuit which allows automatic T/R switching by using the operator's speech modulation.

- 1) Set the VOX GAIN, VOX DELAY and MIC GAIN as shown in the table.

SWITCH/CONTROL	POSITION
VOX SWITCH	ON (IN)
VOX GAIN	FULLY COUNTERCLOCKWISE
VOX DELAY	12 O'CLOCK
MIC GAIN	12 O'CLOCK

- 2) Set the T/R SWITCH in the receive position. It is not necessary to push the PTT SWITCH on the microphone.

- 3) Rotate the VOX GAIN CONTROL clockwise while speaking into the microphone until the T/R switching circuit activates. Stop adjusting the control once the circuit has activated.

- 4) The VOX DELAY CONTROL varies the amount of delay after your speaking stops before the transceiver changes back to the receive mode. Rotate this control counterclockwise to reduce the time delay. Set it to allow for short pauses in normal speech without the IC-751A changing to receive.

- 5) Rotate the ANTI-VOX CONTROL on the top panel clockwise while receiving a signal until the audio from the speaker no longer activates the VOX circuit. Refer to SECTION 3 - 3 for the control location.

The IC-751A has a low distortion, RF speech compressor circuit which provides greater talk power by improving the intelligibility of the transmitted signal over long distances.

- 1) Set the switches and controls as shown in the table.

SWITCH/CONTROL	POSITION
MIC GAIN	CENTER (12 O'CLOCK)
RF POWER	MAXIMUM COUNTERCLOCKWISE
COMP	ON (IN)
METER	COMP

- 2) Switch to transmit and turn the RF POWER CONTROL clockwise while speaking into the microphone until the desired RF "PEAK" output of between approximately 10 watts and 100 watts is obtained.

- 3) Adjust the MIC GAIN CONTROL for a reading of between 10dB and 20dB on the COMPRESSOR (COMP) scale.

- 4) For the best transmit audio, leave the compressor OFF, or use a low mic gain setting with the compressor ON. However, when in contact with DX stations, or under weak signal conditions, the compressor will definitely improve the readability of your signal when it is turned on and adjusted correctly.



### 7 - 3 NOISE BLANKER [NB] OPERATION

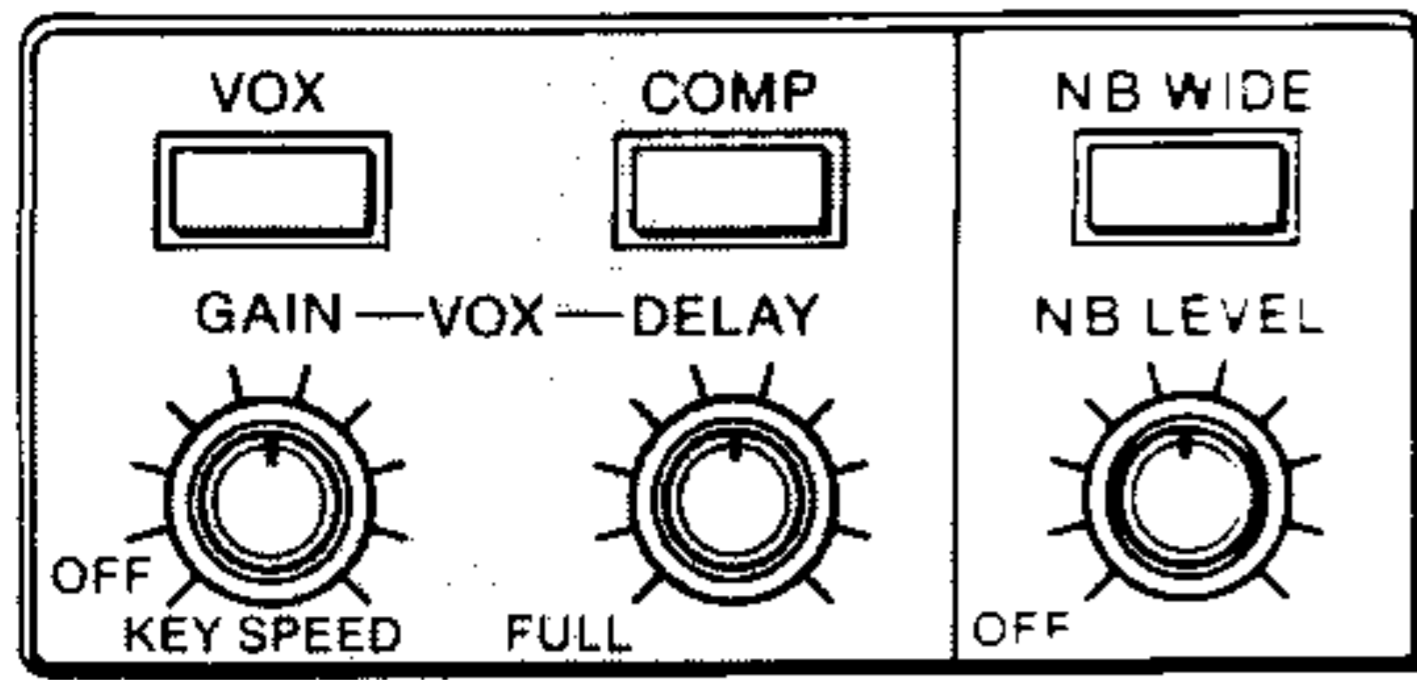

When pulse noise, such as ignition noise from vehicles, makes reception difficult, the NOISE BLANKER effectively reduces this kind of interference.

- 1) Rotate the NB LEVEL CONTROL clockwise from the OFF position beyond the detent when pulse noise is present.
- 2) The noise is suppressed and weak signals which may otherwise have been covered by noise can be received.
- 3) When the NOISE BLANKER TIMING SWITCH is set in the WIDE (locked IN) position, the noise blanker effectively removes long duration pulse noise such as the "woodpecker".

**NOTE:** The noise blanker may not work as well when strong signals are on nearby frequencies, or when the noise is continuous rather than pulse noise.

If the desired receive signal becomes distorted by the action of the noise blanker, either place the NB WIDE SWITCH in the OUT position, or reduce the NB LEVEL CONTROL (turn counterclockwise) until the signal is clear.

### 7 - 4 CW SEMI/FULL BREAK-IN OPERATION

The IC-751A has both semi break-in and full break-in CW capability when using the VOX function. This means the transmit/receive switching is performed automatically by the transceiver whenever the keying starts or stops. The receive to transmit switching time is almost instantaneous whereas the transmit to receive switching time may be varied by an adjustment.

#### ●SEMI BREAK-IN OPERATION USING A STRAIGHT KEY

Wiring for a hand key.

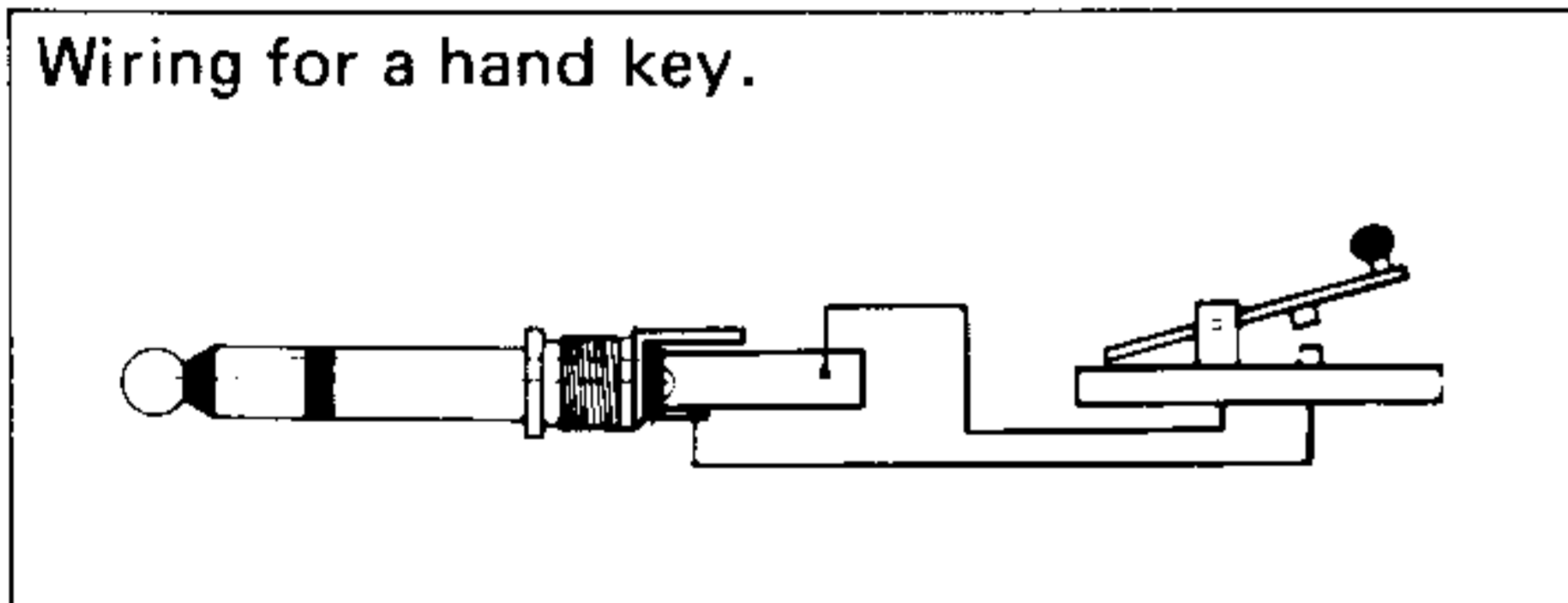

- 1) Set the controls and switches as shown in the table.

SWITCH/CONTROL	POSITION
MODE	CW or CW NARROW
VOX	ON (IN)
KEY SPEED	OFF
VOX DELAY	10 O'CLOCK
TRANSMIT/RECEIVE	RECEIVE

- 2) Set the transmit release delay time to suit your keying speed by adjusting the VOX DELAY CONTROL while keying. Rotate the control clockwise to increase the delay.
- 3) Begin sending with the CW key and the transmitter will switch between transmit and receive automatically.

#### ●SEMI BREAK-IN OPERATION WITH AUTOMATIC KEYING USING AN IAMBIC PADDLE

Automatic keying is possible simply by connecting an iambic paddle. The operator merely controls the number of dots or dashes transmitted without regard to spaces between the elements, or the timing of the elements, within a character. When used correctly, the resulting CW is generally easier and more enjoyable to copy at the receiving end.

Wiring for an iambic paddle.

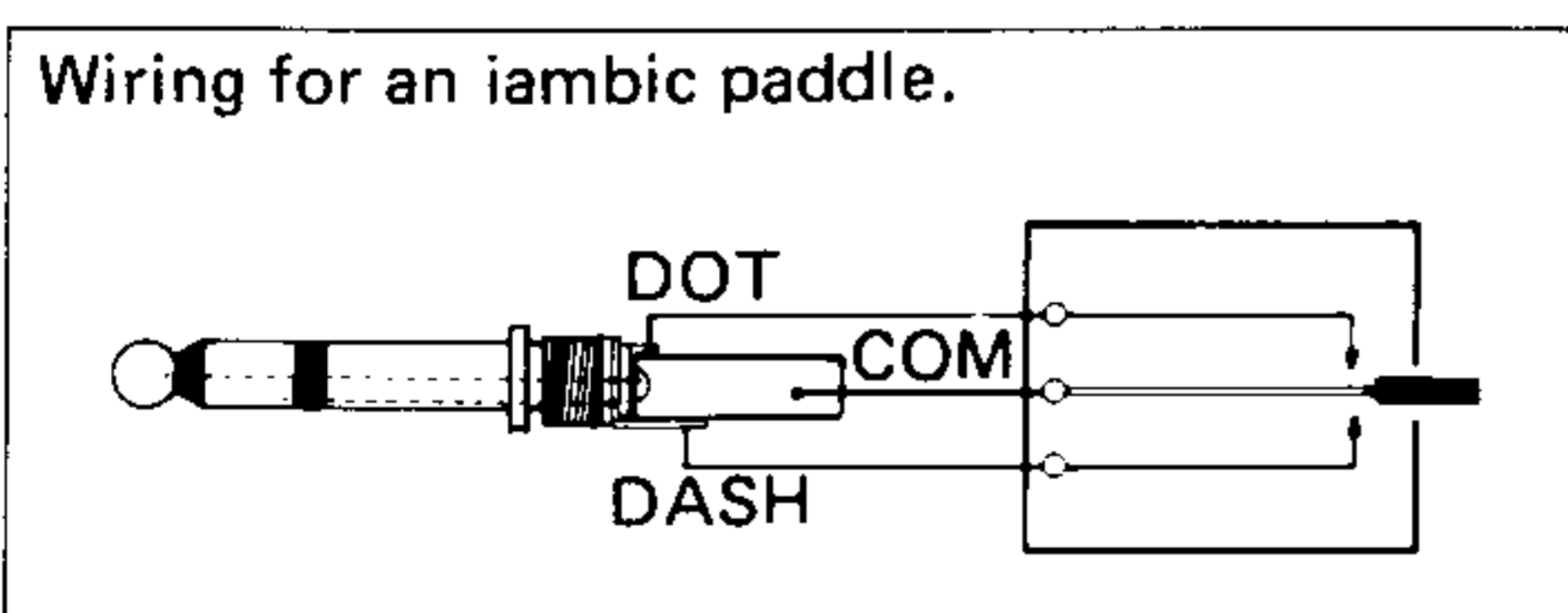

- 1) Set the switches and controls as shown in the table.

**NOTE:** The CW WEIGHT CONTROL is installed on the electronic keyer unit. Refer to SECTIONS 12-3 (3) and 13-2 for the control location.

● **FULL BREAK-IN OPERATION WITH AUTOMATIC KEYING USING AN IAMBIC PADDLE**

SWITCH/CONTROL	POSITION
MODE	CW or CW NARROW
VOX	ON (IN)
KEY SPEED	12 O'CLOCK
VOX DELAY	10 O'CLOCK
TRANSMIT/RECEIVE	RECEIVE

- 2) Adjust the KEY SPEED CONTROL for a suitable keying speed.
- 3) Set the transmit release delay time to suit your keying speed by adjusting the VOX DELAY CONTROL while keying. Rotate the control clockwise to increase the delay.
- 4) The transmit/receive switching is automatically performed by the transceiver.
- 1) Set the switches and controls as shown in the table.

SWITCH/CONTROL	POSITION
MODE	CW or CW NARROW
VOX	ON (IN)
KEY SPEED	12 O'CLOCK
VOX DELAY	FULL (MAX. COUNTERCLOCKWISE)
TRANSMIT/RECEIVE	RECEIVE

- 2) Adjust the KEY SPEED CONTROL for a suitable keying speed.
- 3) The transmit/receive switching is automatically performed by the transceiver.

**7 - 5 SPLIT (DUPLEX) OPERATION**

(Example)

Receiving: 7.057MHz/CW  
Transmitting: 7.255MHz/LSB

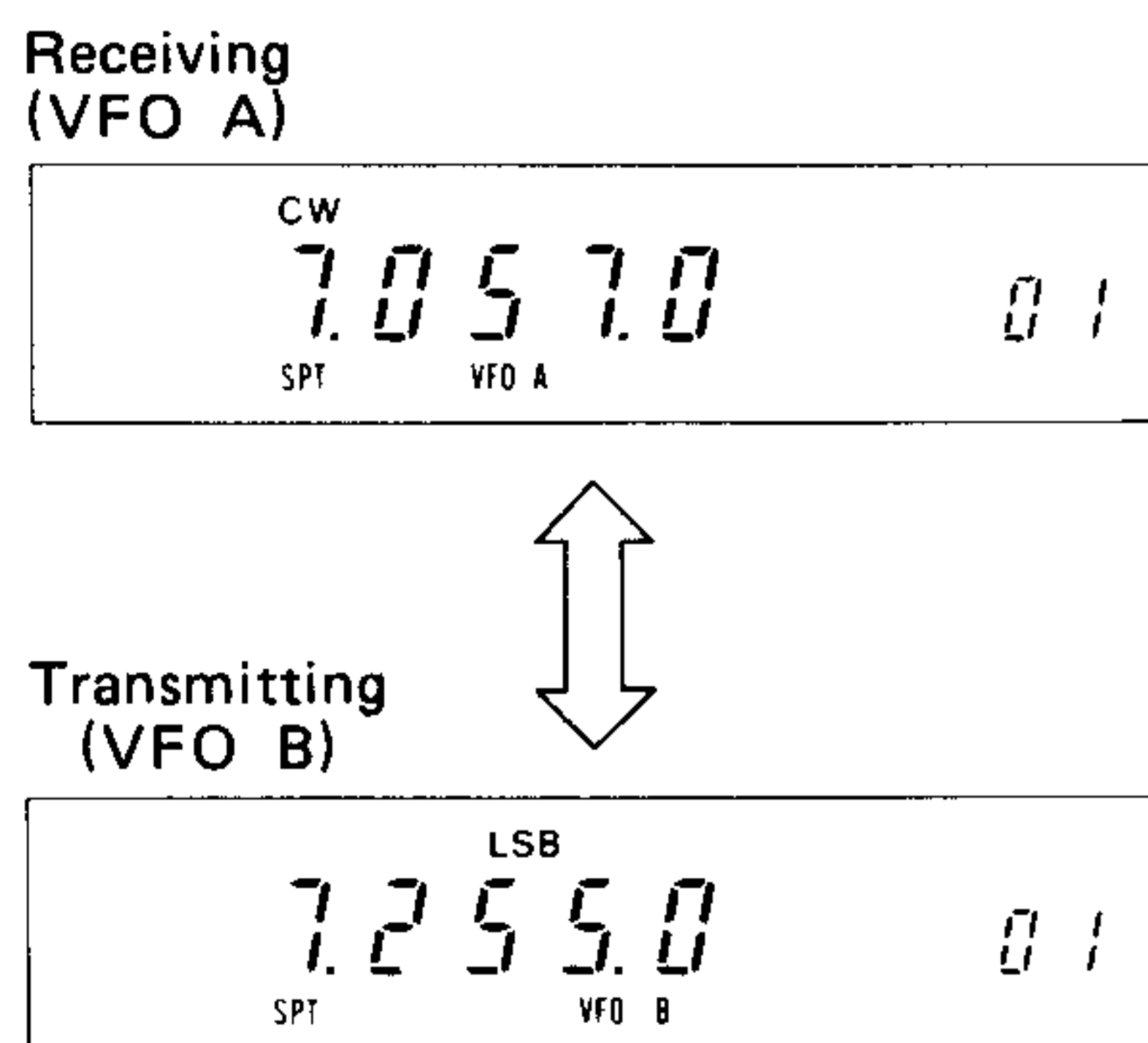

**7 - 6 FM REPEATER OPERATION**

The purpose of the split function is to allow an operator the option of transmitting on a frequency different from the receive frequency. Push the SPLIT SWITCH to turn the function ON or OFF.

- 1) Store the frequency 7.057MHz in VFO A and 7.255MHz IN VFO B.
- 2) Push the VFO A/B SWITCH to select VFO A, then push the SPLIT SWITCH to select the split function. The letters "SPT" on the display illuminate.
- 3) The receive frequency is now set for 7.057MHz and the transmit frequency is 7.255MHz. Push the VFO A/B SWITCH once again in order to receive on 7.255MHz and transmit on 7.057MHz.

Each VFO also stores the operating mode in addition to the operating frequency. This allows crossmode contacts to be made easily.

A tone encoder is often required to access HF FM repeaters. The UT-30 PROGRAMMABLE TONE ENCODER is available as an accessory for use with the IC-751A.

Refer to SECTION 10 - 5 for installation instructions.

- Input both TX and RX frequencies to VFO and VFO B.

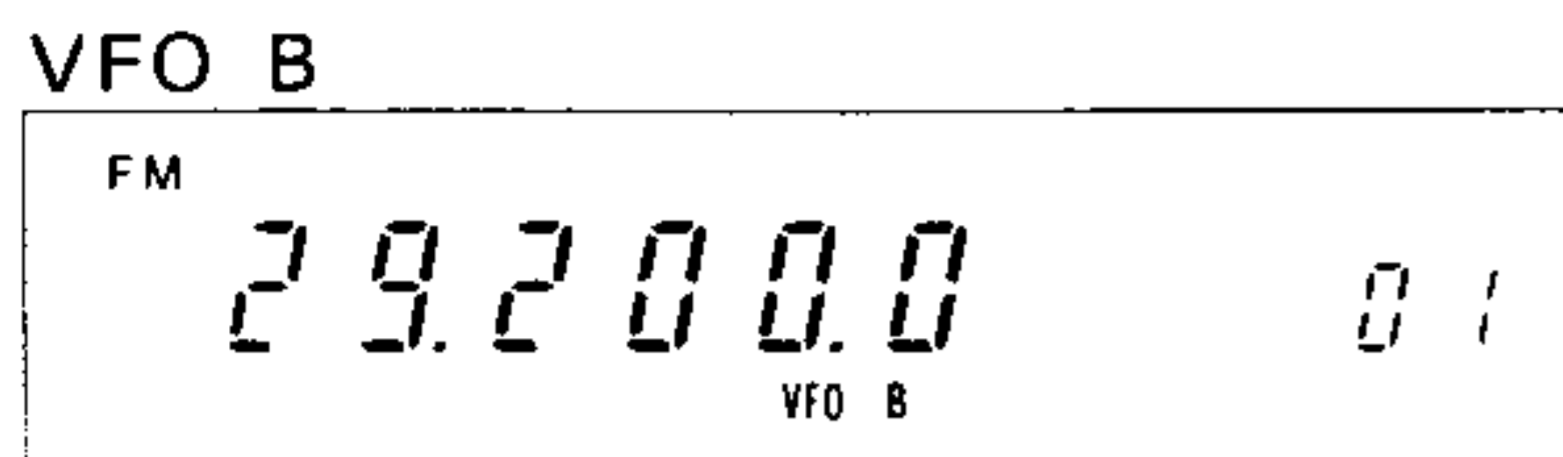
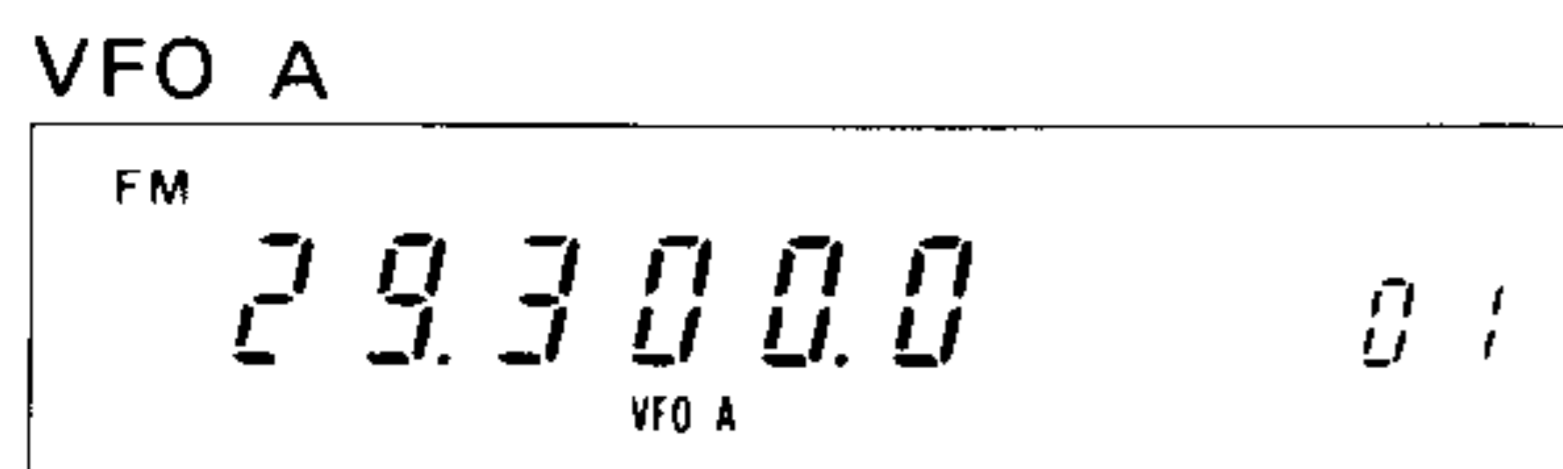

Push the SPLIT SWITCH.

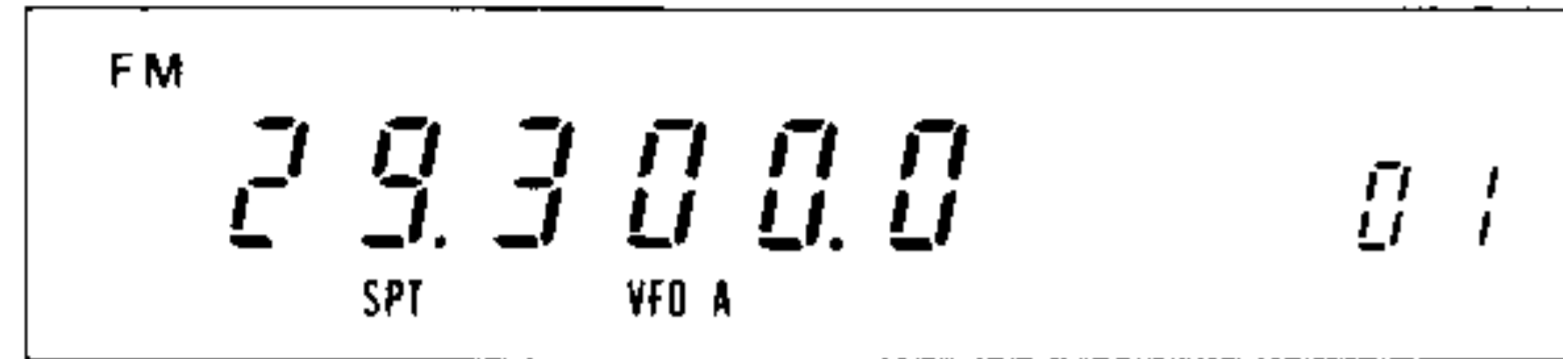

### 7-7 PASSBAND TUNING (PBT) OPERATION

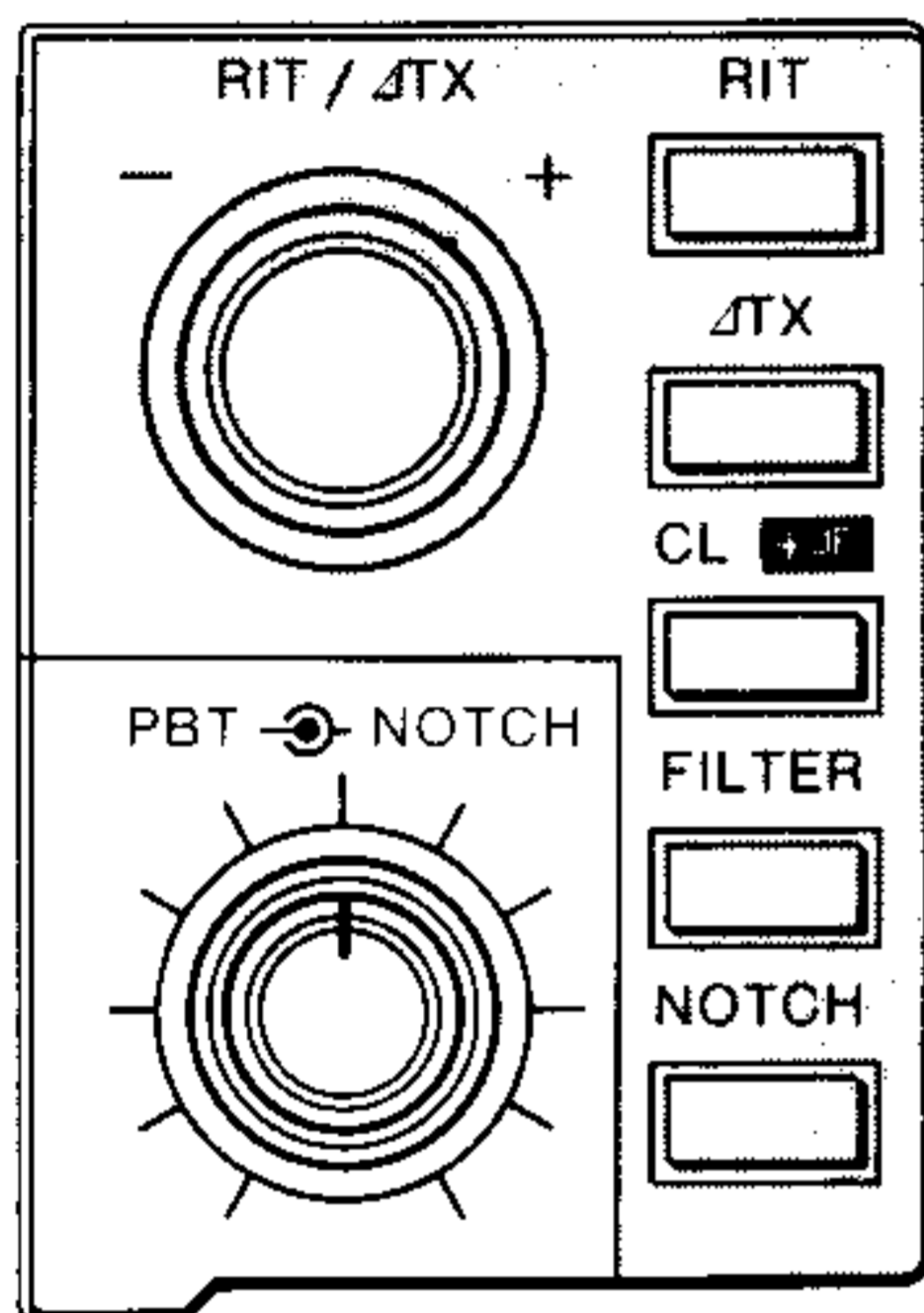

- 1) After installing the UT-30 in the transceiver, push the FM MODE SWITCH and program both the transmit and receive frequencies into VFO A and VFO B, respectively.
- 2) Push the SPLIT SWITCH to select the split (duplex) operation.
- 3) Select the transmit mode with either the T/R SWITCH or the PTT SWITCH.
- 4) Push the FUNCTION SWITCH while transmitting. The red LED lights and indicates the programmed tone is being transmitted.
- 5) Push the FUNCTION SWITCH again to cancel the tone.

**NOTE:** If no UT-30 is installed, the FUNCTION INDICATOR lights but no tone signal is transmitted.

Passband Tuning is a system designed to electronically narrow the bandwidth (selectivity) of frequencies that will pass through the receive crystal filter.

- 1) The PBT CONTROL has a detent at the center (12 o'clock) position. This position provides the widest bandwidth, and the control should normally be left here.
- 2) The PBT CONTROL may also be used to adjust the tone of the receive audio for maximum intelligibility.
- 3) While receiving in the LSB mode, narrow the bandwidth by turning the PBT CONTROL counterclockwise to eliminate interference from lower frequencies (interfering signals are high pitched). Turn the PBT CONTROL clockwise to eliminate interference from higher frequencies (interfering signals are low pitched).
- 4) While receiving in the USB mode, the bandwidth is reduced in the opposite manner. Narrow the bandwidth by turning the PBT CONTROL clockwise to eliminate interference from higher frequencies (interfering signals are high pitched). Turn the PBT CONTROL counterclockwise to eliminate interference from lower frequencies (interfering signals are low pitched).

**NOTE:** The passband tuning does not function when the transceiver is in the AM or FM mode.

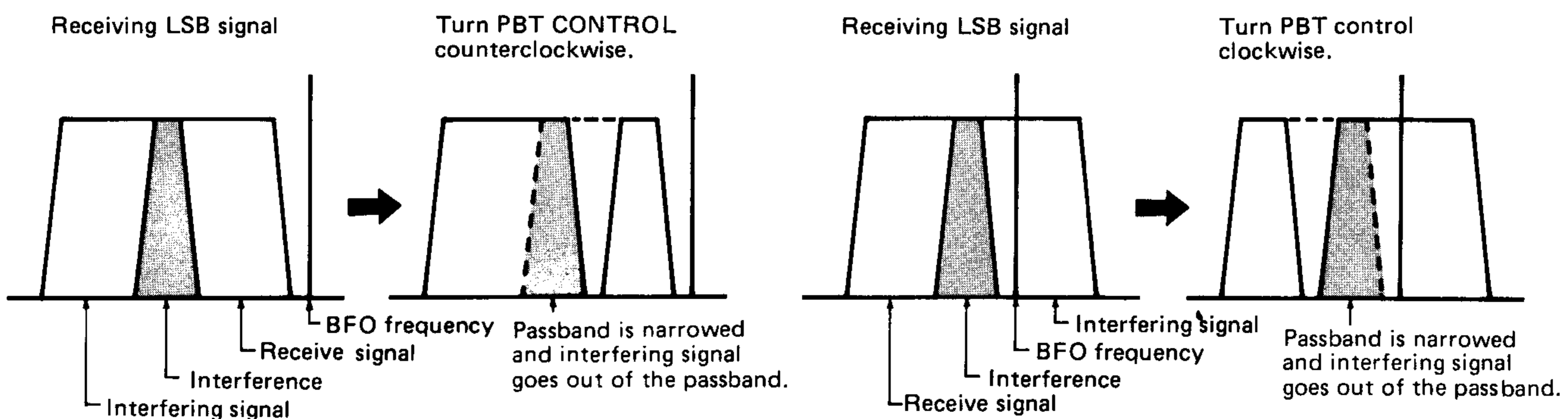

### 7 - 8 NOTCH FILTER OPERATION

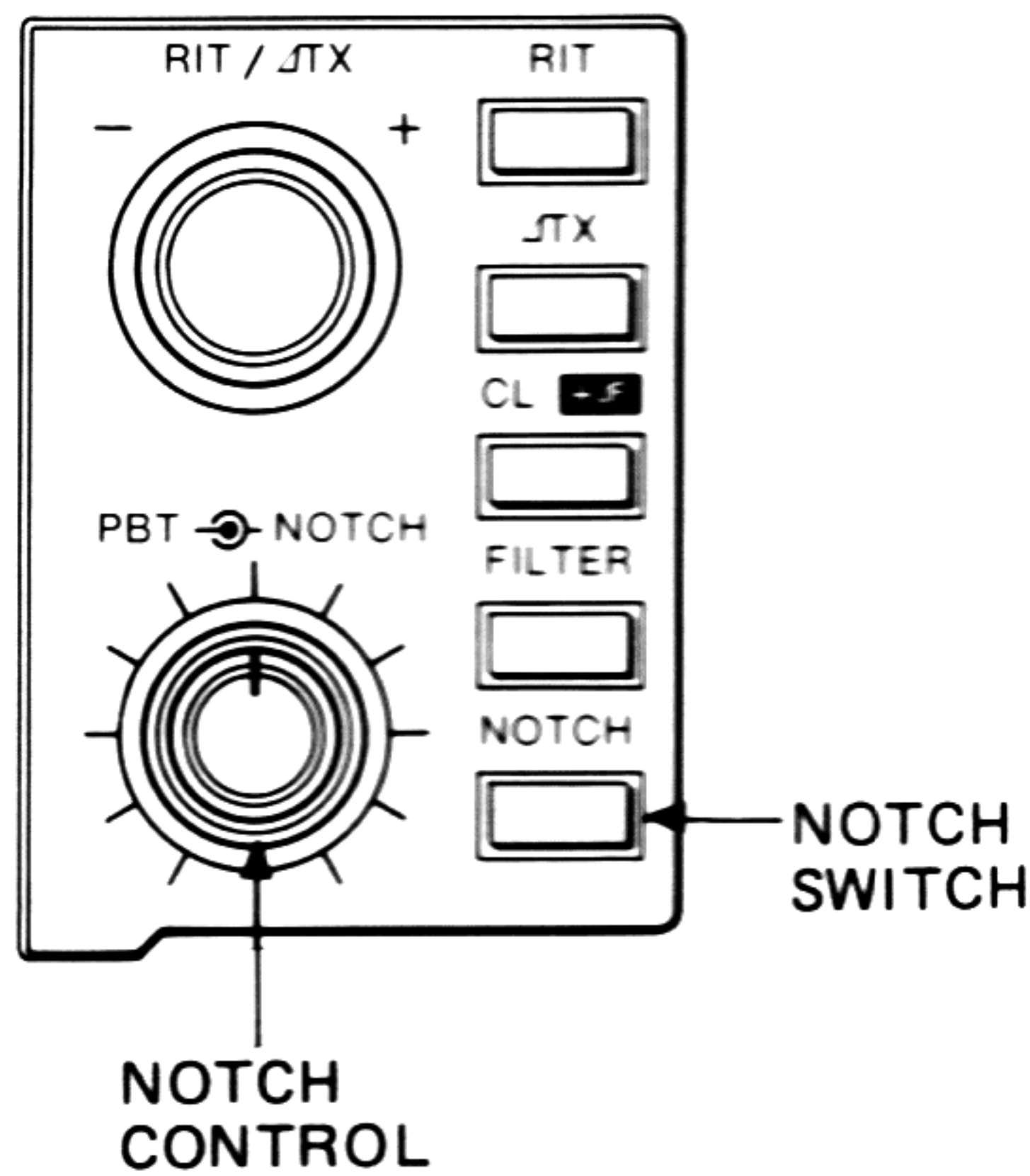

This circuit provides high attenuation at one particular frequency in the IF passband. It may be used to reduce or eliminate interfering heterodyne signals that fall within the passband of the receiver.

- 1) Push the NOTCH FILTER SWITCH to the ON position (IN).
- 2) Adjust the NOTCH FILTER CONTROL to minimize interference.

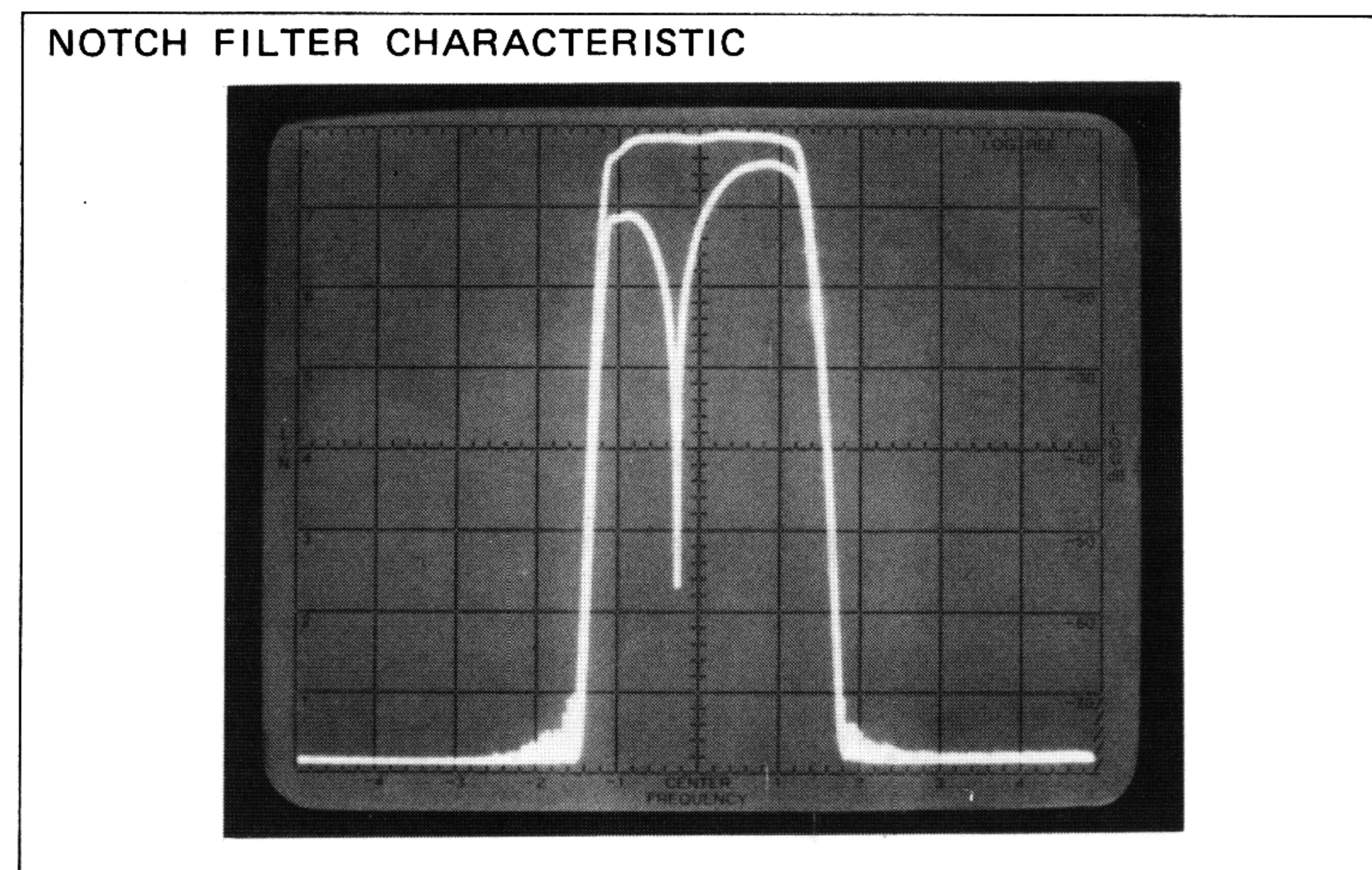

### 7 - 9 FILTER SWITCH OPERATION

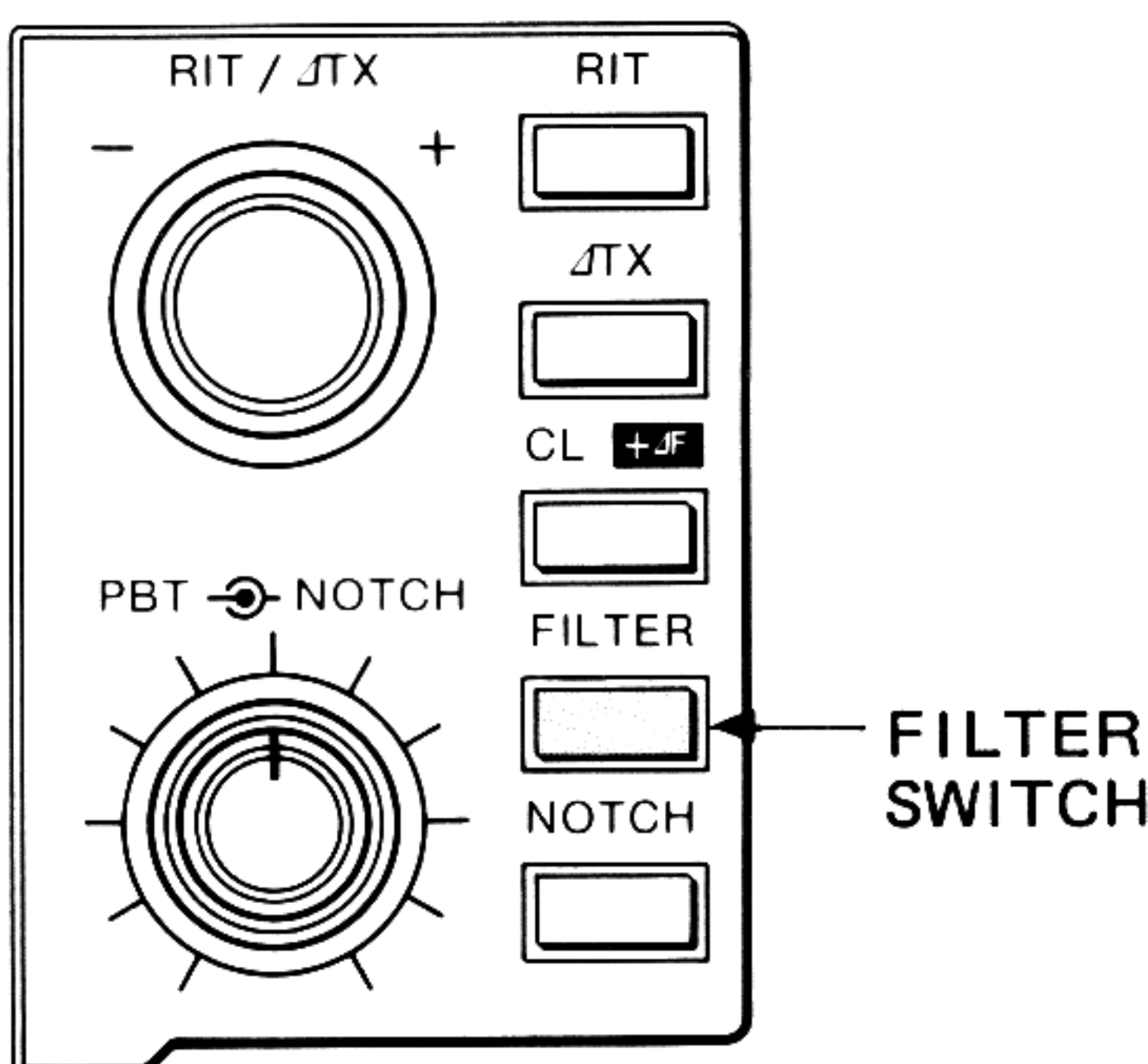

This switch selects the different combinations of the internal receive filters.

FILTER SWITCH	SSB	CW/RTTY	*1 CW/RTTY NARROW	AM	FM
OUT	2.3kHz	*2 500Hz	500/250Hz	*4 8kHz	15kHz
IN	2.6kHz	*3 2.3kHz	500/250Hz	*5 3kHz	15kHz

\*1: CW NARROW or RTTY NARROW mode requires either an optional FL-52A or FL-53A narrow filter.

\*2, \*3: Internal preset switch S4 on the MAIN unit reverses these narrow and wide filters:  
 FILTER SWITCH OUT: 2.3kHz  
 FILTER SWITCH IN : 500Hz

\*4, \*5: Internal preset switch S3 on the MAIN unit reverses these wide and narrow filters:  
 FILTER SWITCH OUT: 3kHz  
 FILTER SWITCH IN : 8kHz

### 7 - 10 RIT/ΔTX OPERATION

#### ●RIT OPERATION

- 1) Push RIT SWITCH to turn ON the RIT.

Receive : 14.267.8MHz  
 Transmit: 14.267.8MHz

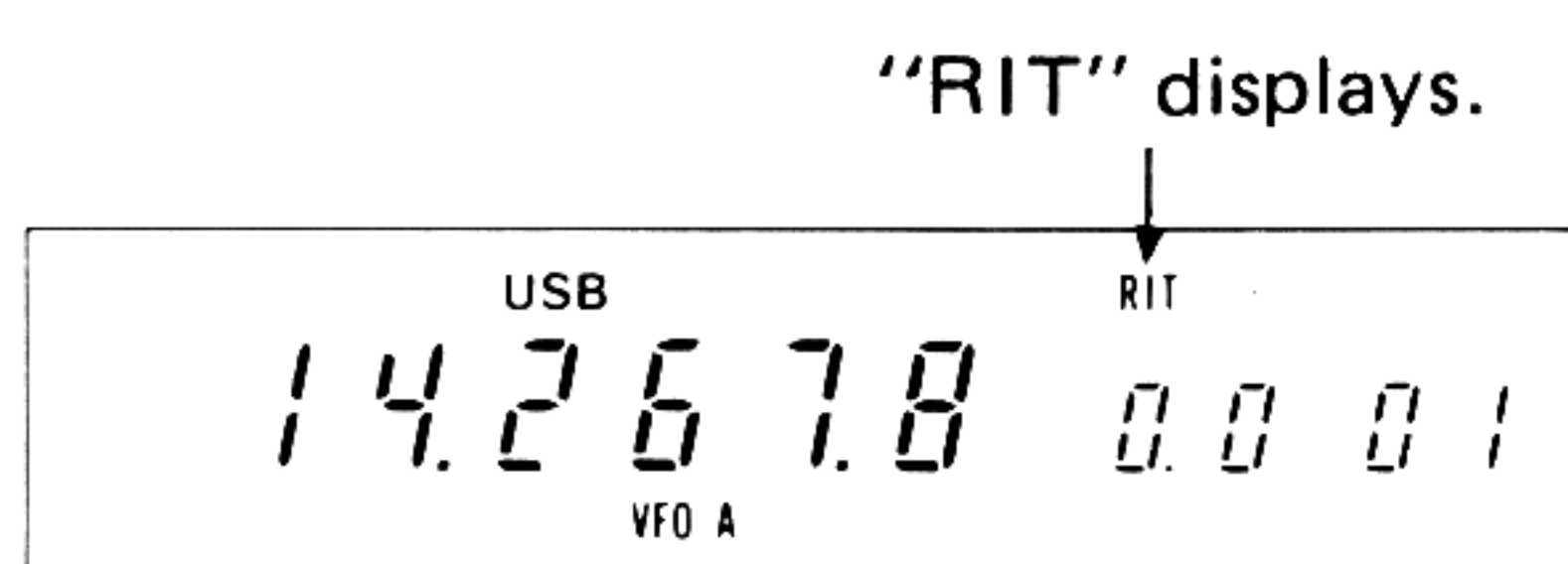

By using the RIT circuit, it is possible to shift the receive frequency up to 9.9kHz to either side of the transmit frequency without moving the transmit frequency. This is useful for fine tuning stations which call off frequency or for compensating for frequency drift.

- 1) Push the RIT SWITCH once to turn the RIT circuit ON. The letters "RIT" and the amount of shift are displayed.

2) Rotate INCREMENTAL TUNING CONTROL counterclockwise.

Receive : 14.2639MHz  
Transmit: 14.2678MHz



3) Push RIT SWITCH to turn OFF the RIT.

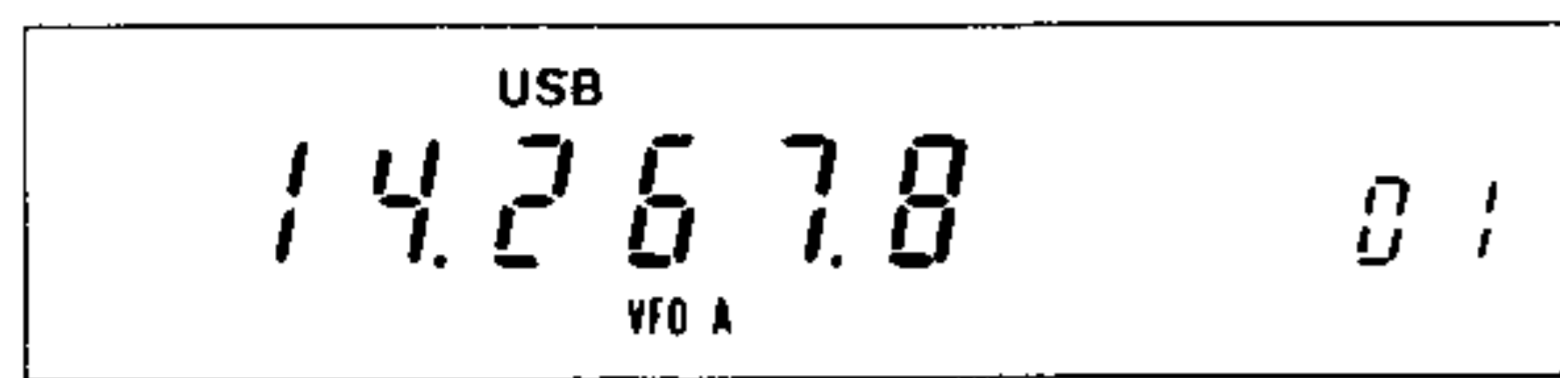

4) Push the RIT SWITCH again to turn ON the RIT.

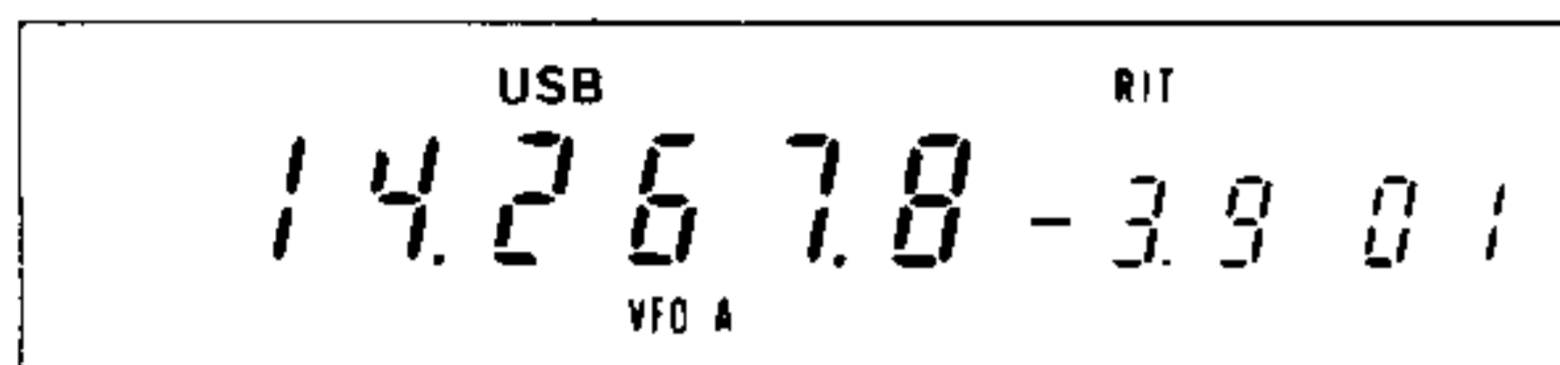

5) Push the RIT/ΔTX CLEAR SWITCH.

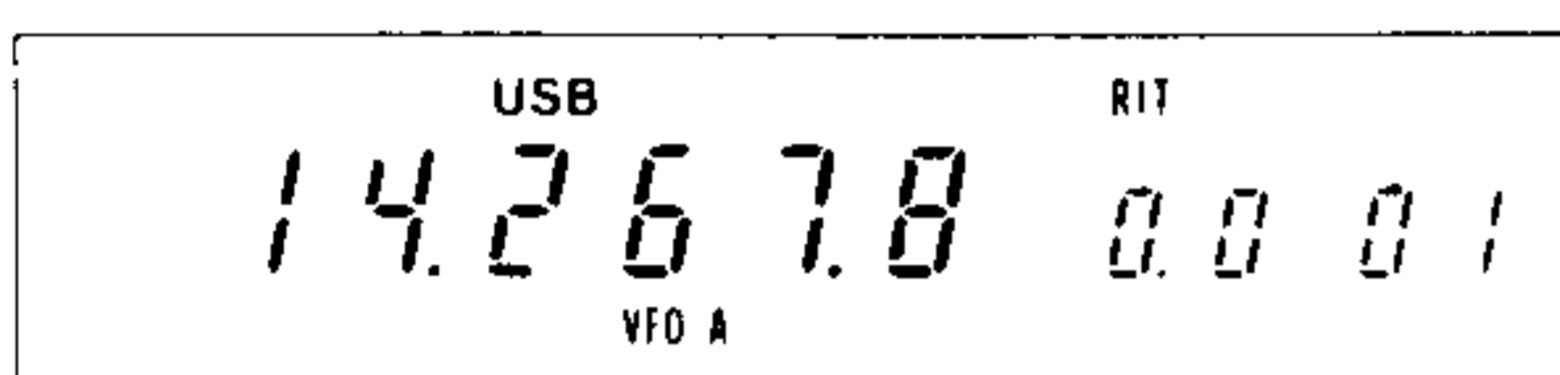

6) Push FUNCTION SWITCH, then push RIT/ΔTX CLEAR SWITCH.

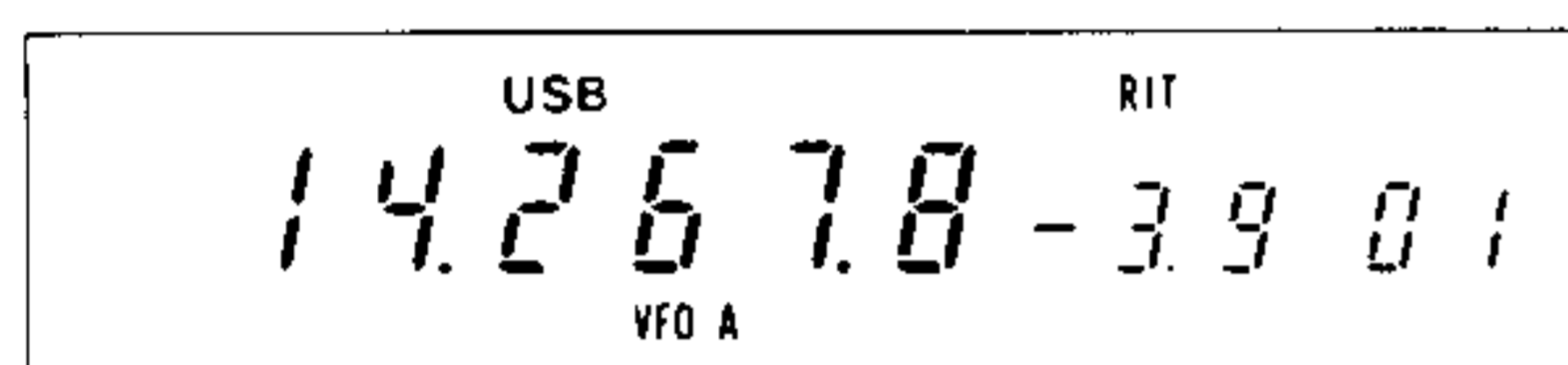

### ● ΔTX OPERATION

1) Push the ΔTX SWITCH to turn ON the ΔTX circuit.

Receive : 14.2678MHz  
Transmit: 14.2678MHz

"ΔTX" displays.

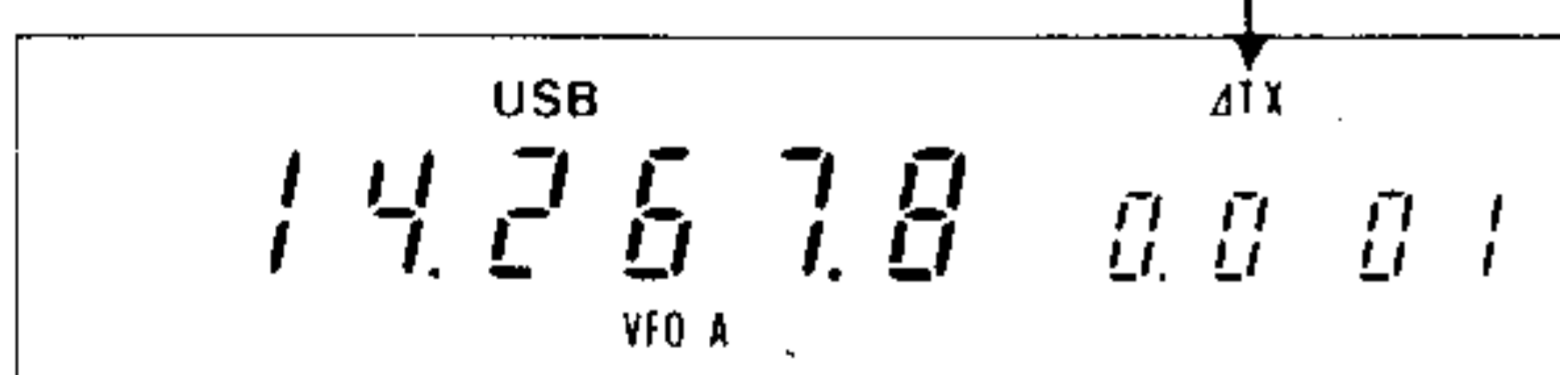

2) Rotate the INCREMENTAL TUNING CONTROL counterclockwise.

Receive : 14.2678MHz  
Transmit: 14.2639MHz

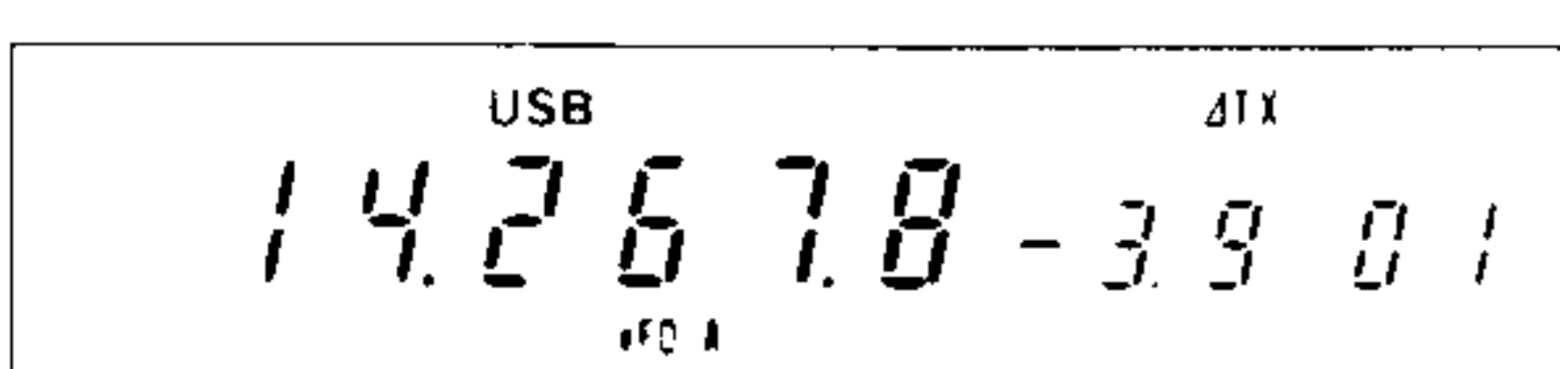

2) The receive frequency can be shifted in 10Hz steps by adjusting the INCREMENTAL TUNING CONTROL. Rotating the control in the (+) direction raises the receive frequency, and in the (-) direction lowers it.

3) To turn OFF the RIT function, push the RIT SWITCH again. The letters "RIT" and the amount of shift are no longer displayed.

4) When the RIT circuit is OFF, the transmit and receive frequencies are the front panel displayed frequency. They are the same regardless of the amount of shift previously selected with the INCREMENTAL TUNING CONTROL. However, the RIT shift value is stored in a memory for later use when the RIT function is again activated.

5) To clear the RIT shift, push the RIT/ΔTX CLEAR SWITCH. The shift value resets to 0.0 and the receive and transmit frequencies become the same whether the RIT function is ON or OFF.

6) To add the RIT shift value to the displayed frequency, push the FUNCTION SWITCH, then push the RIT/ΔTX CLEAR SWITCH. The RIT shift value automatically resets to 0.0.

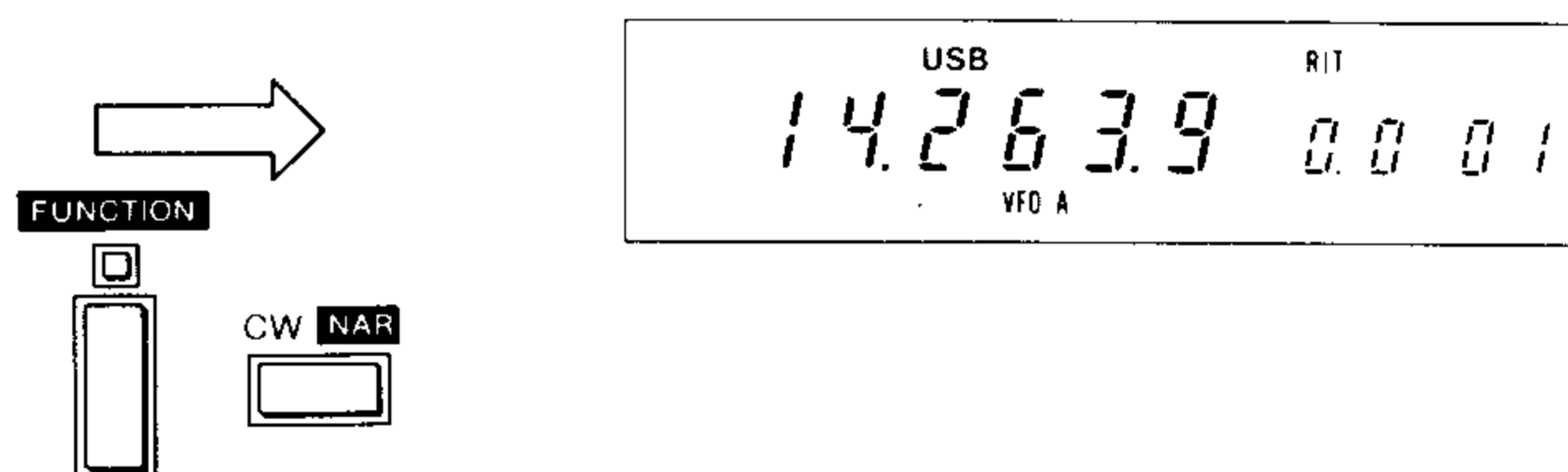

The ΔTX circuit allows the transmit frequency to be shifted up to 9.9kHz to either side of the receive frequency without moving the receive frequency. This function is similar in operation to the RIT function.

1) Push the ΔTX SWITCH to turn ON the ΔTX circuit. The letters "ΔTX" and the amount of shift are displayed.

2) The transmit frequency can be shifted in 10Hz steps by adjusting the INCREMENTAL TUNING CONTROL.

3) RIT function activated.

Receive : 14.2639MHz  
Transmit: 14.2678MHz



Push RIT SWITCH to turn OFF the RIT.

Receive : 14.2678MHz  
Transmit: 14.2678MHz

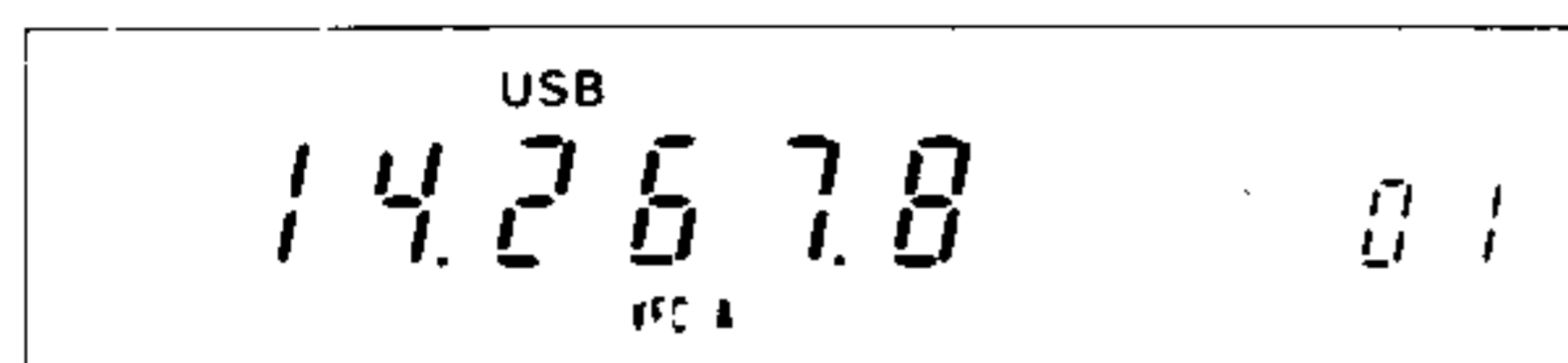

4) RIT already activated.

Receive : 14.2639MHz  
Transmit: 14.2678MHz

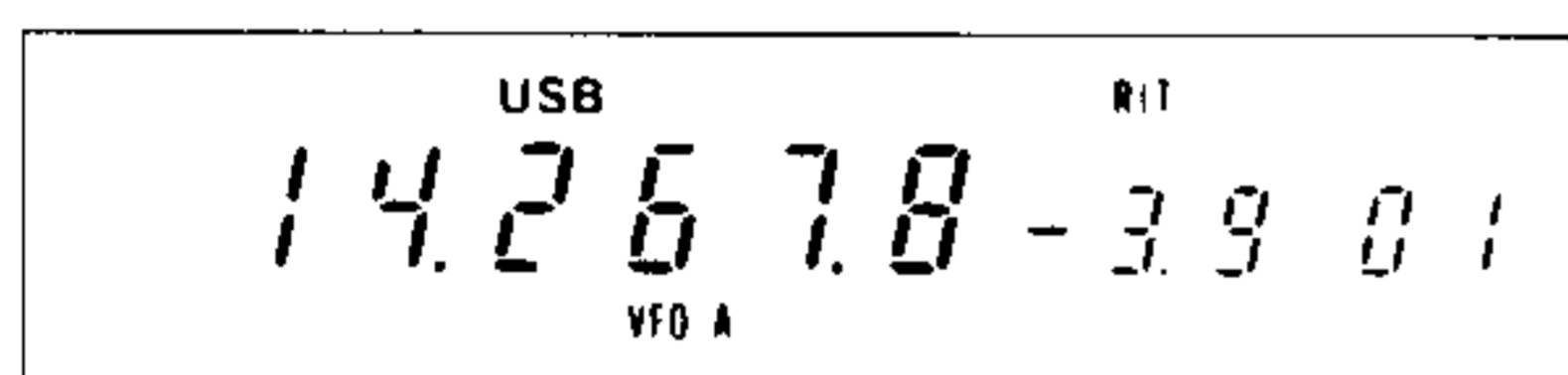

Push  $\Delta$ TX SWITCH to turn ON the  $\Delta$ TX function.

Receive : 14.2639MHz  
Transmit: 14.2639MHz

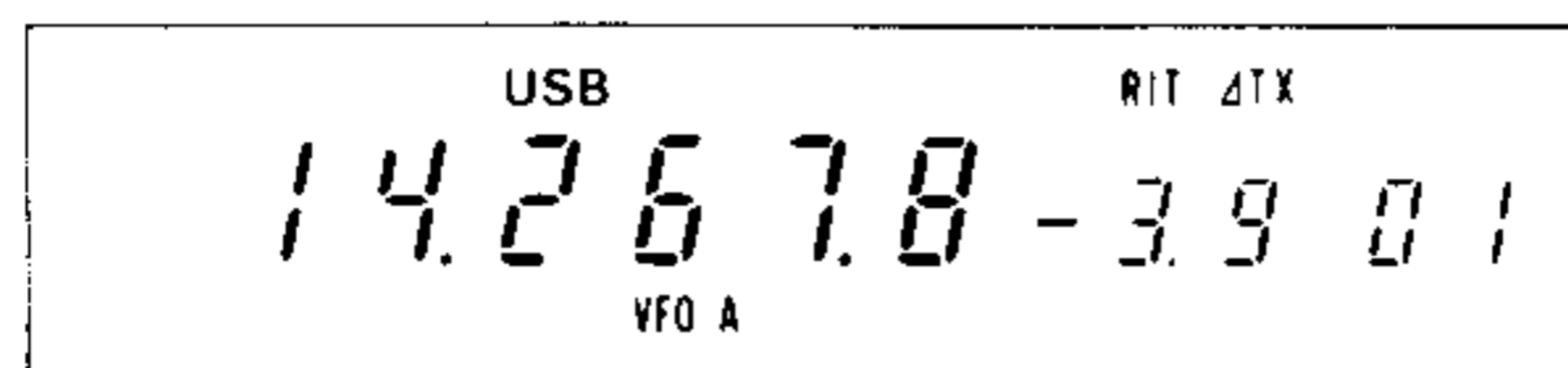

5) Push  $\Delta$ TX SWITCH to turn OFF the  $\Delta$ TX function.

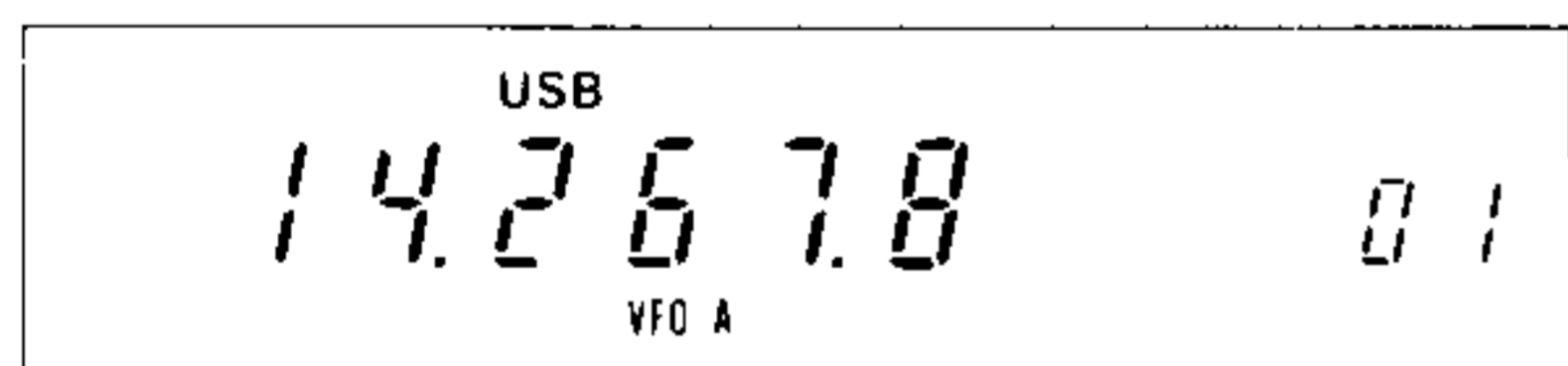

6) Push  $\Delta$ TX SWITCH to again turn ON the  $\Delta$ TX function.

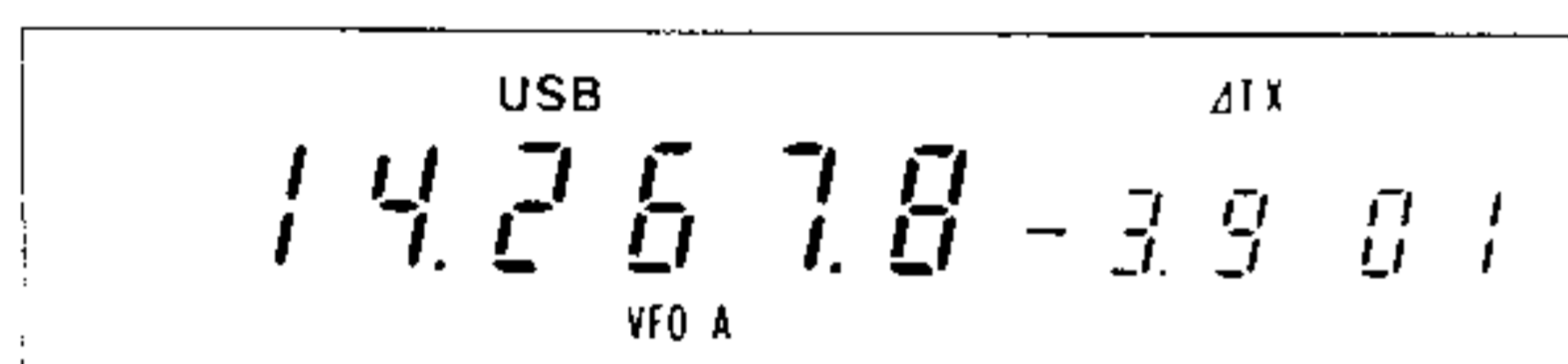

## 7 - 11 MONITOR OPERATION

3) As with the RIT function, the amount of shift selected with the INCREMENTAL TUNING CONTROL is maintained in a memory whether the  $\Delta$ TX function is ON or OFF. A shift value selected while the RIT was activated becomes the  $\Delta$ TX shift when the  $\Delta$ TX function is turned ON.

Push  $\Delta$ TX SWITCH to turn ON the  $\Delta$ TX function.

Receive : 14.2678MHz  
Transmit: 14.2639MHz

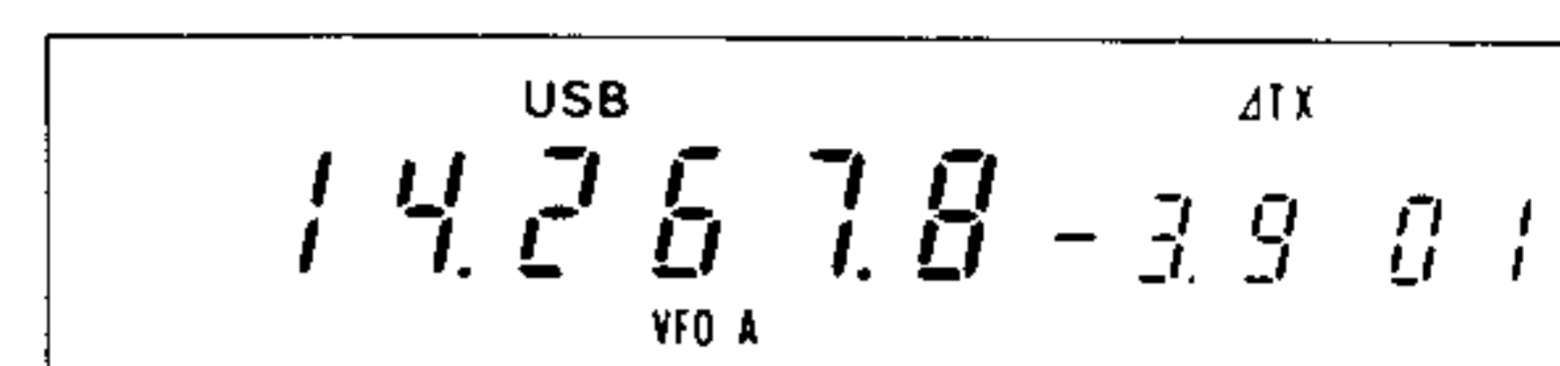
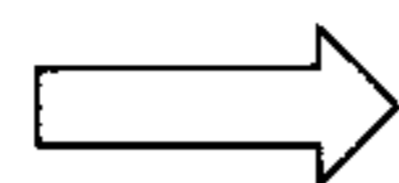

4) If the RIT and  $\Delta$ TX functions are both activated, the receive and transmit frequencies will be equal but shifted from the displayed frequency by the shift value. Varying the INCREMENTAL TUNING CONTROL changes both the transmit and receive frequencies simultaneously.

Push RIT SWITCH to turn OFF the RIT function.

Receive : 14.2678MHz  
Transmit: 14.2639MHz

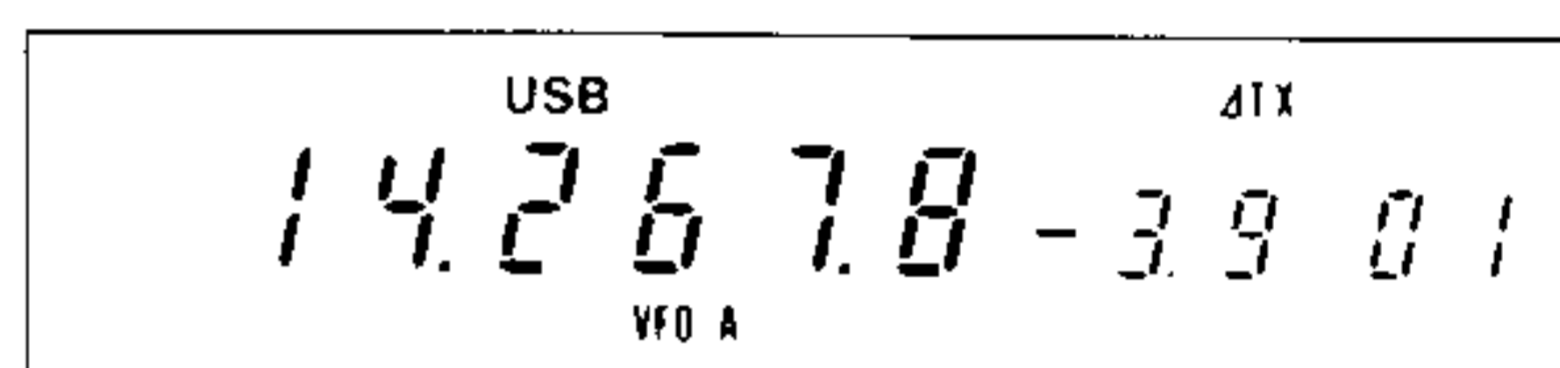
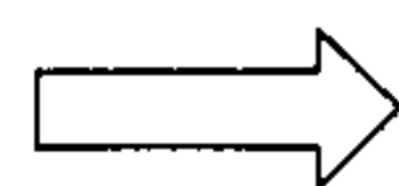

5) Push the  $\Delta$ TX SWITCH again to turn OFF the  $\Delta$ TX function. The letters " $\Delta$ TX" and the amount of shift are no longer displayed.

6) When the  $\Delta$ TX function is OFF, the transmit and receive frequencies are as indicated on the frequency display regardless of what amount of shift is selected. Activation of the  $\Delta$ TX function recalls the shift value from memory.

7) To add the  $\Delta$ TX shift value to the displayed frequency, push the FUNCTION SWITCH, then push the RIT/ $\Delta$ TX CLEAR SWITCH. The value of the  $\Delta$ TX shift automatically resets to 0.0.

The transmit IF signal may be monitored while using SSB if desired. This circuit is included to allow checking of the quality of the transmitted signal, especially useful when using the RF speech compressor.

1) Turn the MONITOR SWITCH on the top cover ON.

2) Adjust the MONITOR LEVEL CONTROL on the top panel for a comfortable audio level.

3) Wear headphones while using the monitor function to prevent howling sounds caused by feedback.

See SECTION 3 - 3 TOP PANEL for the control and switch locations.

## 7 - 12 MICROPHONE UP/DOWN OPERATION

### ●FREQUENCY CONTROL

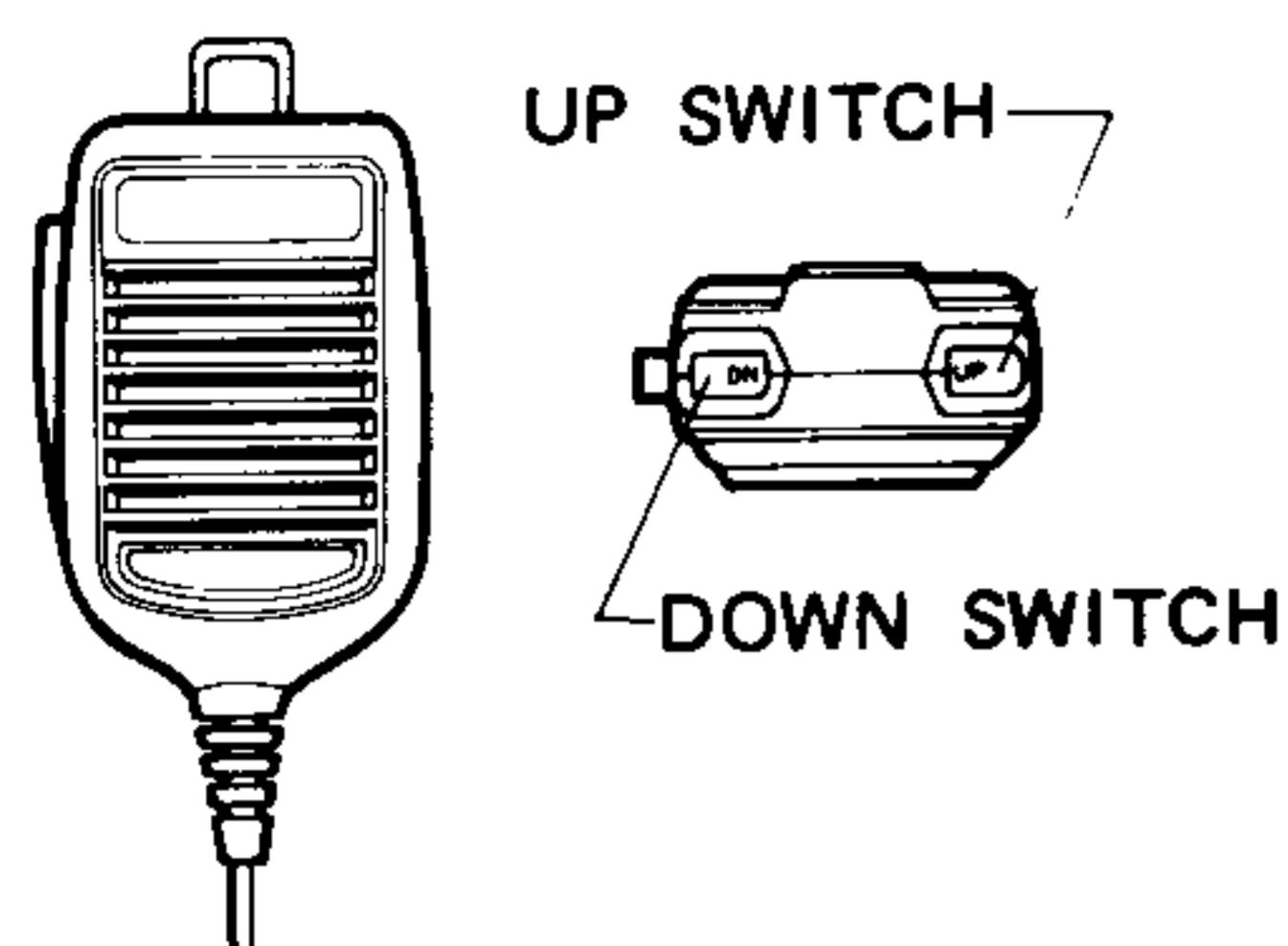

### ●MEMORY CHANNEL SELECTION

- 1) Each push of the UP or DN (down) SWITCH on the supplied microphone changes the operating frequency one increment up or down respectively.
- 2) Holding either switch down changes the operating frequency continuously in the same manner as turning the TUNING CONTROL. The tuning rate must be set with the TUNING SPEED SWITCH.

This up/down function is effective for changing your operating frequency when using the VFO mode, or when using the MEMORY CHANNEL mode with the DFS SWITCH pushed IN.

- 1) When using the MEMORY CHANNEL mode, the memory channel may be changed with the microphone up/down switches. Also, in the VFO mode with the DFS SWITCH pushed IN, the displayed memory channel number may be changed in the same way.
- 2) The memory channel or the displayed memory channel number changes every two seconds if the microphone switches are held down.

## 7 - 13 AGC OPERATION

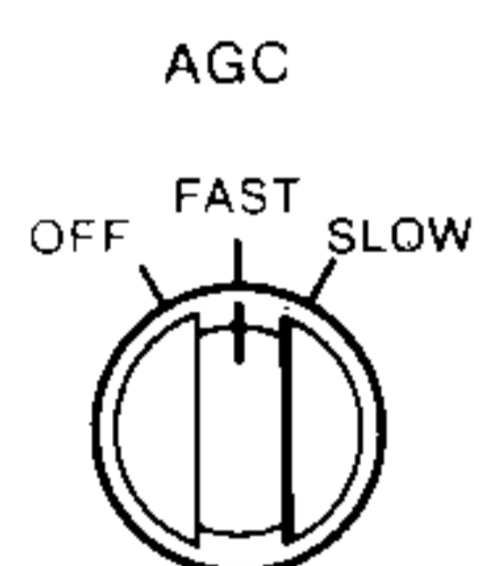

The IC-751A has a fast attack/slow release AGC system which maintains the peak voltage of the rectified IF signal from the IF amplifier circuit for a brief period of time. This circuit keeps irritating background noise from being heard during the short pauses in speech. The damping effect of the AGC therefore allows accurate S-meter readings to be taken of the peak IF signal strength.

- 1) For normal SSB reception, select the SLOW position.
- 2) For CW or AM signals, or for SSB signals with short interval fading, select the FAST position. In the FAST position, the time constant of the circuit is shortened.
- 3) In the OFF position, the AGC circuit is deactivated and the S-meter gives no signal strength readings. In this case, the RF GAIN CONTROL is useful to reduce the receiver gain when strong signals are received. Adjustment of the RF GAIN CONTROL affects the meter reading as described in Item ⑧ of SECTION 3 - 1 FRONT PANEL.

## 7 - 14 PREAMP/ATT SWITCH OPERATION

### ●PREAMP SWITCH OPERATION

Place the PREAMP/ATT SWITCH on the top panel in the PRE AMP position when receiving weak signals. An RF preamplifier is inserted in the receive path which increases receiver sensitivity.

### ●ATTENUATOR (ATT) SWITCH OPERATION

Place the PREAMP/ATT SWITCH in the ATT position when receiving very strong signals. In the ATT position, the RF preamplifier is removed from the receive path and a 20dB attenuator is inserted. This helps to reduce interference.

Leave the PREAMP/ATT SWITCH in the OFF position for normal operation.

See SECTION 3 - 3 for the switch location.

## SECTION 8 MEMORY AND SCANNING OPERATION

The IC-751A has thirty-two memory channels numbered 01 through 32. One frequency and the operating mode may be assigned to each memory channel whether the transceiver is in the VFO mode or the MEMORY CHANNEL mode.

Remember the following when storing frequencies in memories:

**MEMO 01, 02:** These channels are used as band limits for the PROGRAMMED SCAN function.

### 8 - 1 MEMORY CHANNEL SELECTION

- 1) Turn ON the POWER.

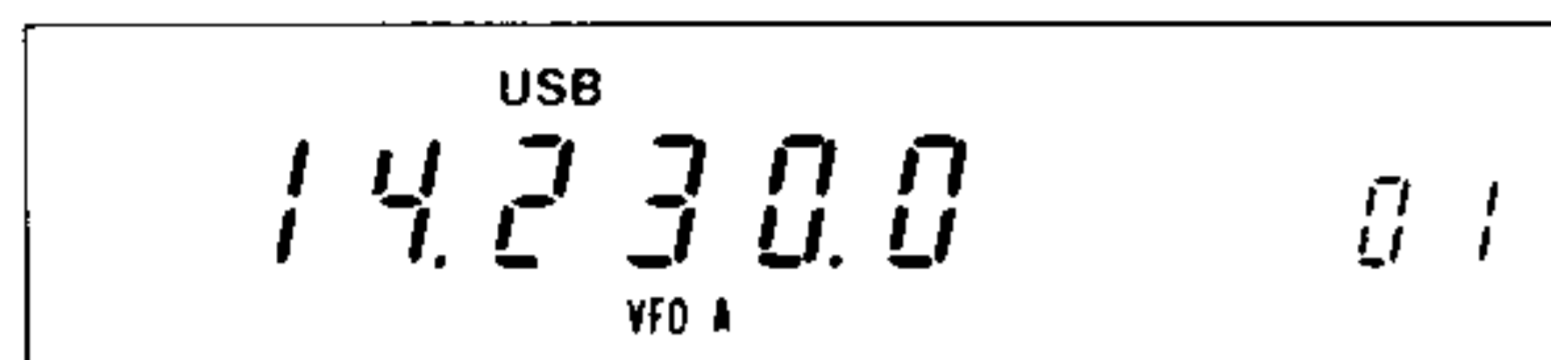

- 2) Push the VFO/M SWITCH.

"MEMO" displays.

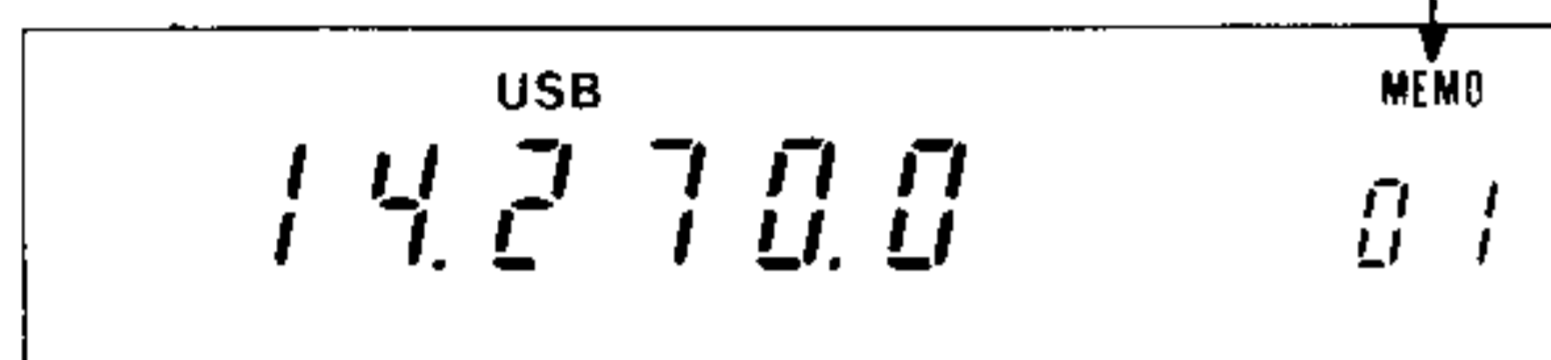

- 3) Rotate the TUNING CONTROL.

Turning the TUNING CONTROL clockwise.

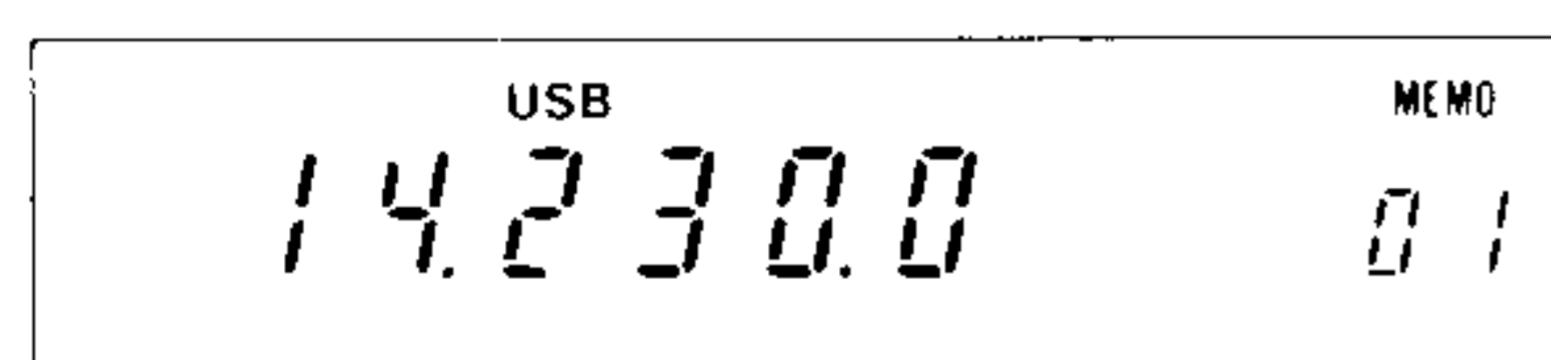
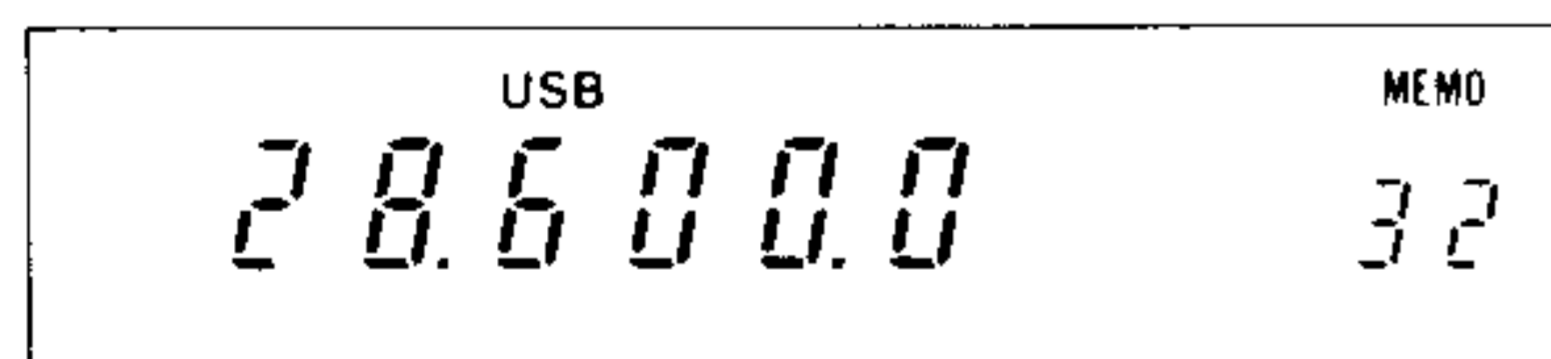
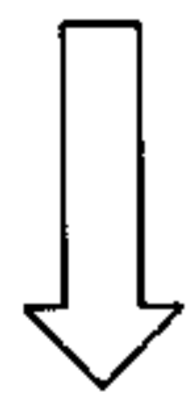
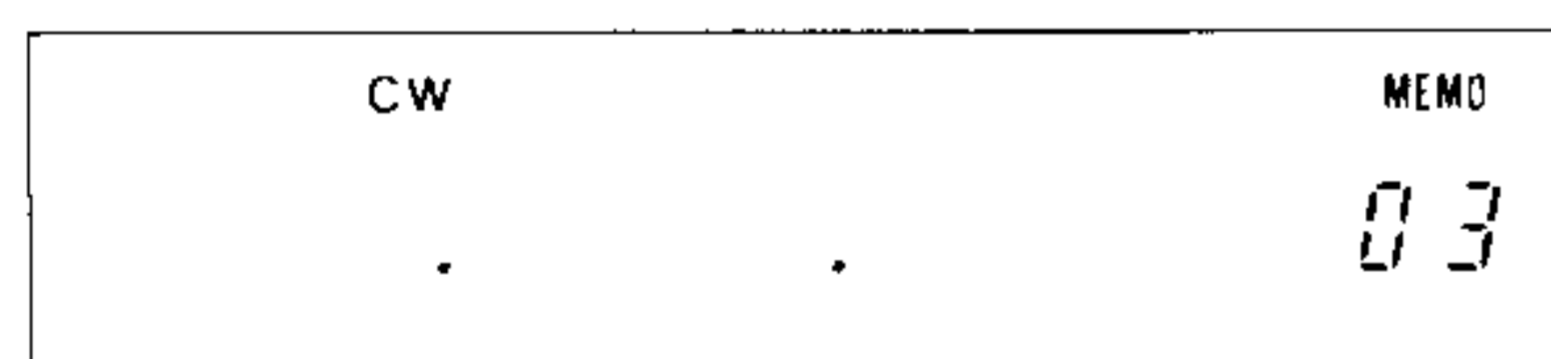
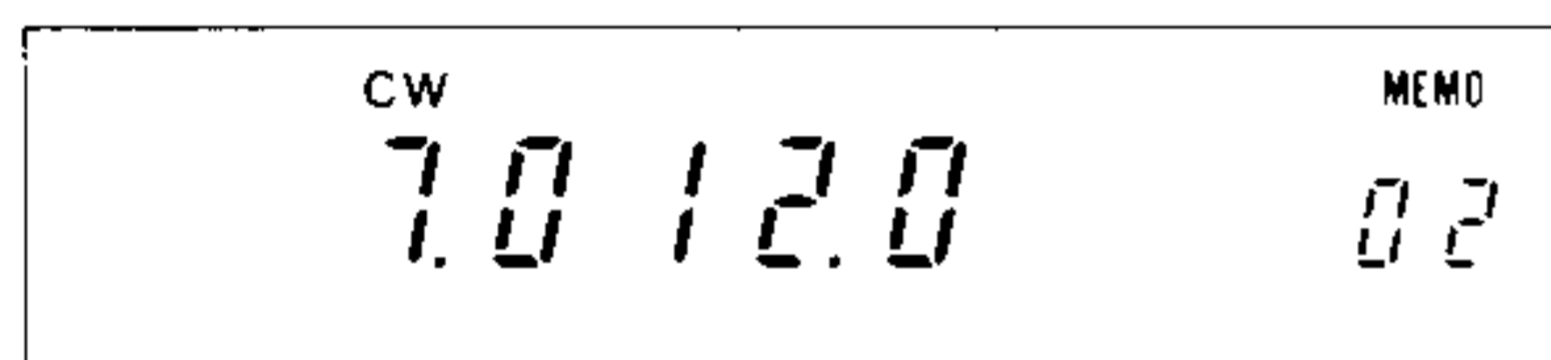
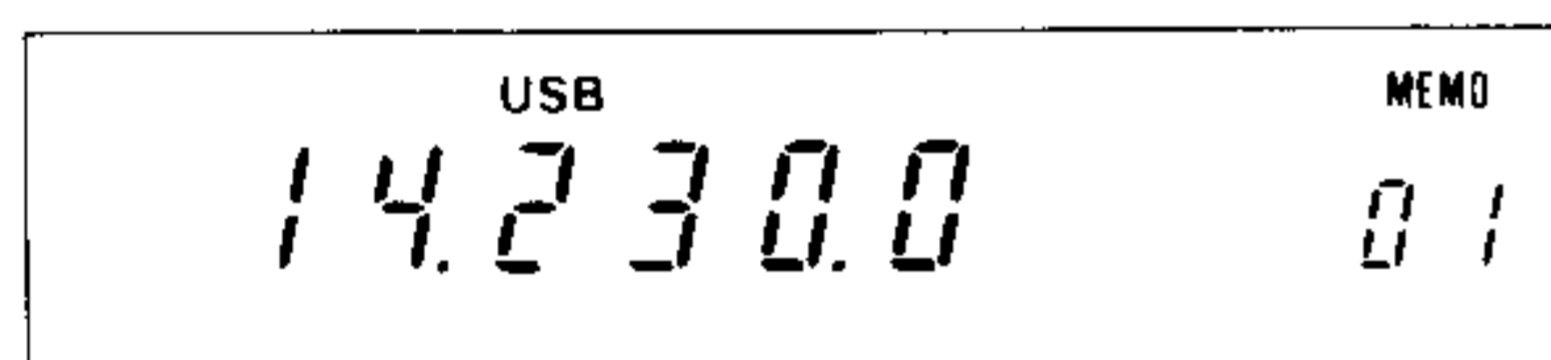

- 1) When the power switch is turned ON, the transceiver automatically selects VFO A and displays "01".

- 2) Push the VFO/MEMORY SWITCH to place the transceiver in the MEMORY CHANNEL mode.

The frequency, operating mode and HAM/GENE mode which have been stored in memory channel 01 are displayed. The letters "MEMO" above the memory channel number indicate that the MEMORY CHANNEL mode is currently selected.

- 3) Rotate the TUNING CONTROL to select any of the memory channels. When memory channels not yet programmed are selected, only the MHz and kHz decimal points appear on the display. In this case, the transceiver continues to operate on the memory channel or VFO which was selected immediately prior to selecting the non-programmed channel.

### 8 - 2 PROGRAMMING MEMORY CHANNELS

- 1) Select operating parameters.

Frequency, mode and HAM/GENE mode will be memorized.

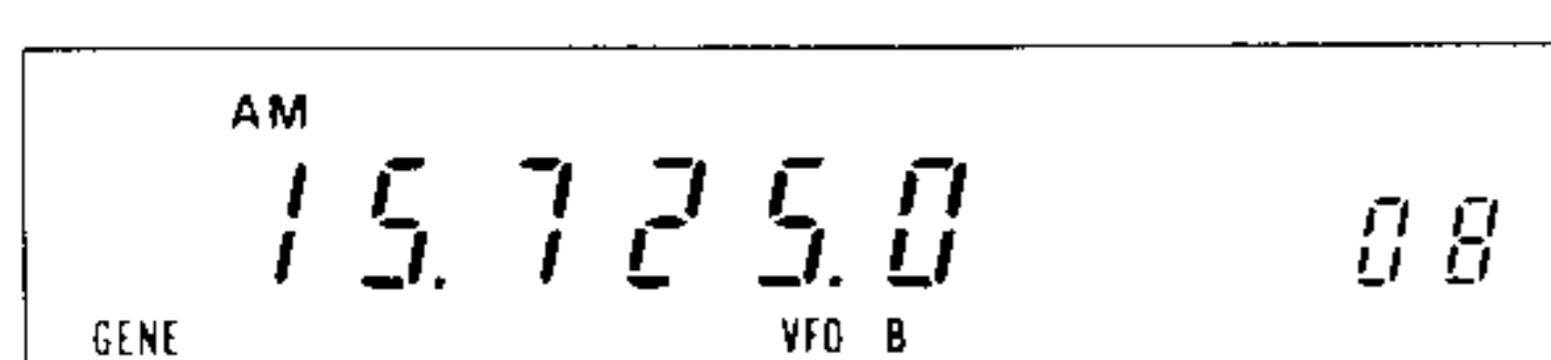

Any frequency, operating mode and HAM/GENE mode may be memorized in any memory channel.

- 1) Select your desired frequency, operating mode, and HAM or GENE mode. Either VFO may be used while selecting these parameters.

For example, select "15.725MHz", "AM" and "GENE" with VFO B.



- 2) Push IN the DFS SWITCH and select a memory channel.

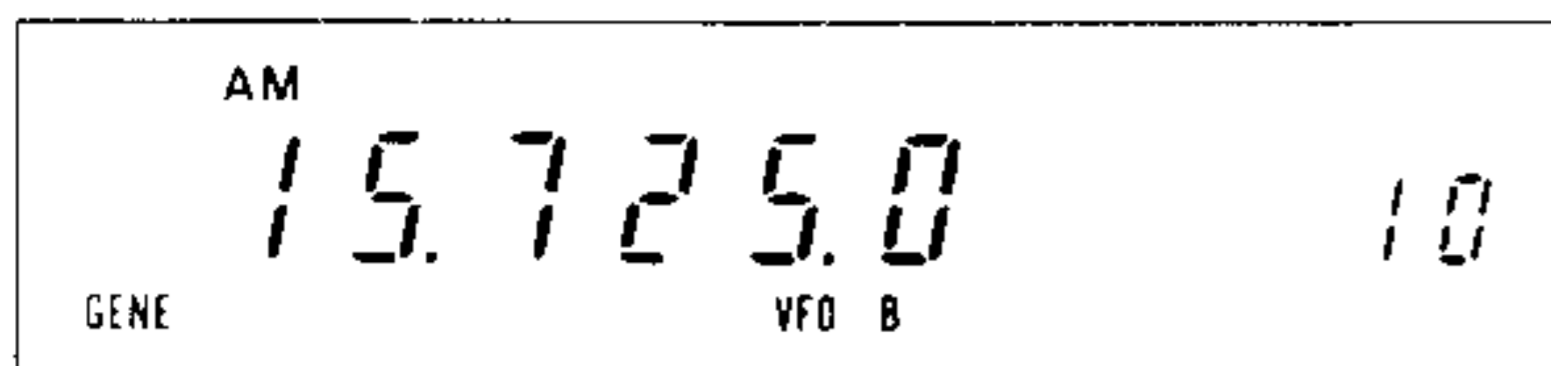

- 3) Push VFO/M SWITCH to check present contents of selected memory.

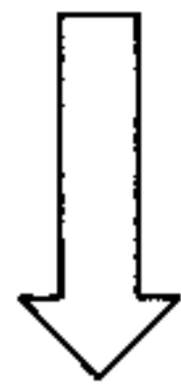
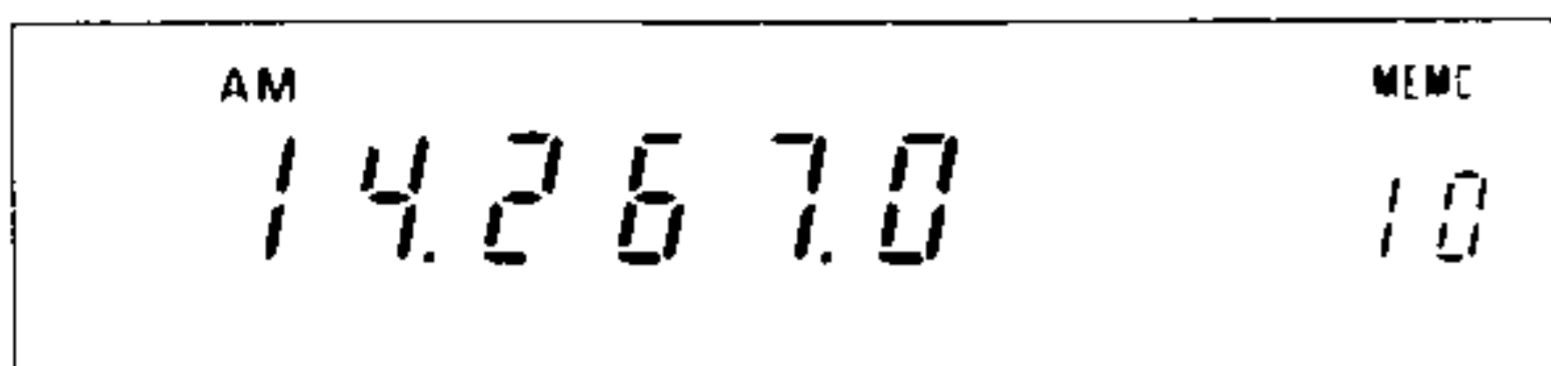

Push VFO/M SWITCH to return to VFO mode.

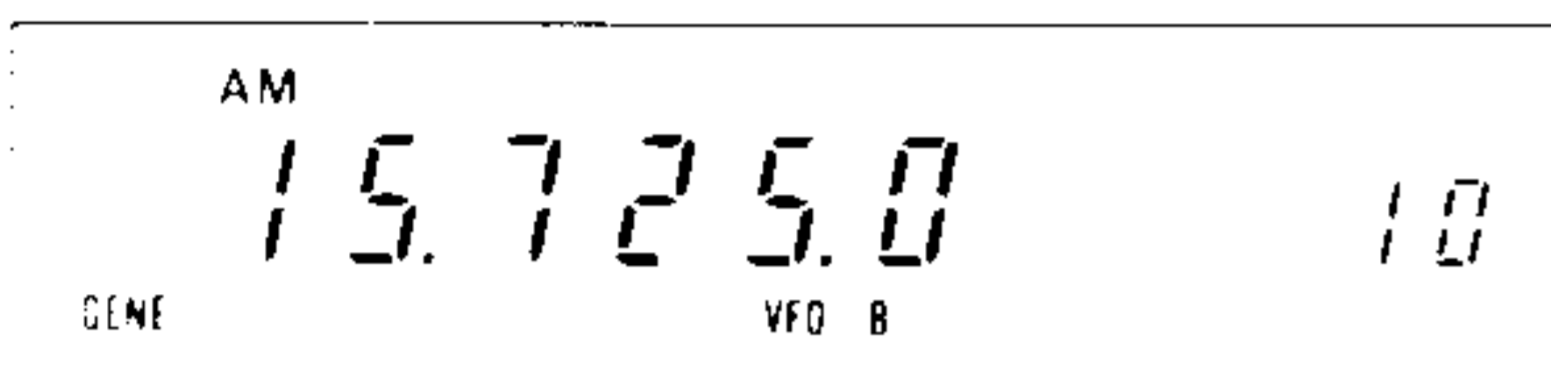

- 4) Push the WRITE SWITCH to store the new data. The display appears as below after pushing the VFO/M SWITCH again.

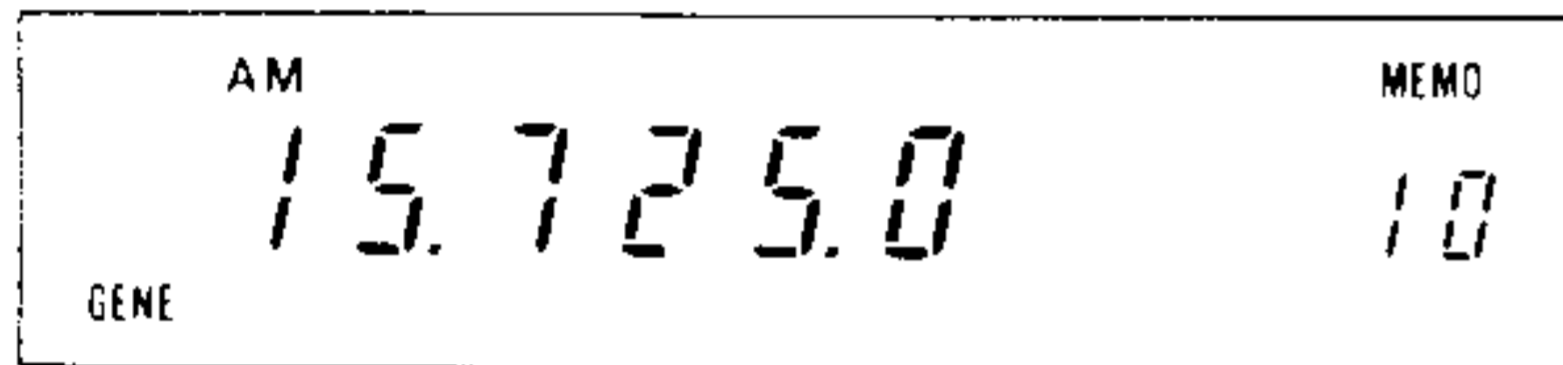

### 8 - 3 MEMORY CLEARING

- 1) Select memory channel.
- 2) Push FUNCTION SWITCH, then push either WRITE SWITCH or M ► VFO SWITCH.

### 8 - 4 MEMORY SCAN

- 1) Program memory channels.
- 2) Adjust SQUELCH CONTROL.
- 3) Push SCAN SWITCH.
- 4) Scan stops when receive signal opens squelch.
- 5) Use SCAN SWITCH to manually stop/start scan.

- 2) Push IN the DFS SWITCH, then select a memory channel using the TUNING CONTROL. For example, select memory channel 10.

- 3) To check the memory channel contents, push the VFO/MEMORY SWITCH. The contents of the selected memory channel are displayed. If you do not wish to erase the contents of this particular memory channel, select either a different memory channel which contains a frequency that can be erased, or select a channel that is vacant. Vacant channels display only the MHz and kHz decimal points. Return to the VFO mode by pushing the VFO/MEMORY SWITCH.

- 4) Push the WRITE SWITCH. The previous memory contents (if any) are erased and the new frequency, mode and HAM/GENE mode are stored in the memory channel.

In the example, the frequency 15.725MHz with the AM mode is now programmed in memory channel 10, and ready for use with the GENERAL COVERAGE receiver.

- 1) Select the memory channel to be cleared (erased).
- 2) Push the FUNCTION SWITCH, then push either the MEMORY WRITE SWITCH (WRITE) or the FREQUENCY TRANSFER SWITCH (M ► VFO).

The memory channel is now vacant.

This function is used to automatically scan all programmed memory channels.

- 1) Program the desired frequencies into memory channels.

**NOTE:** Random frequencies were stored in the memory channels at the factory for testing purposes.

- 2) Adjust the SQUELCH CONTROL to quiet the noise output from the speaker.
- 3) Push the SCAN SWITCH, and the IC-751A begins scanning the programmed channels from the highest channel towards the lowest channel. The scan skips unprogrammed channels if there are any.
- 4) Provided the squelch is closed when the scan begins, the scan stops when a receive signal opens the squelch. After approximately 10 seconds, the scan resumes.
- 5) Push the SCAN SWITCH to stop the scanning function manually. Turning the TUNING CONTROL also stops the scan. Push the SCAN SWITCH again to resume scanning.

## 8-5 MODE SCAN

- 1) Push VFO/M SWITCH.
- 2) Adjust SQUELCH CONTROL.
- 3) Push MODE-S SWITCH.
- 4) Push SCAN SWITCH.

## 8-6 PROGRAMMED SCAN

- 1) Store the scan limits in memory channels 01 and 02.

**NOTE:** Store both scanning limits in MEMO 01 and MEMO 02 using either the HAM or the GENE mode. HAM mode limits must be in the same band.

- 2) Select VFO A or B with VFO A/B SWITCH.
- 3) Adjust SQUELCH CONTROL.
- 4) Push SCAN SWITCH.
- 5) Scan stops when a signal opens the squelch. Scan resumes after 10 seconds.

## 8-7 SCAN RESUMPTION

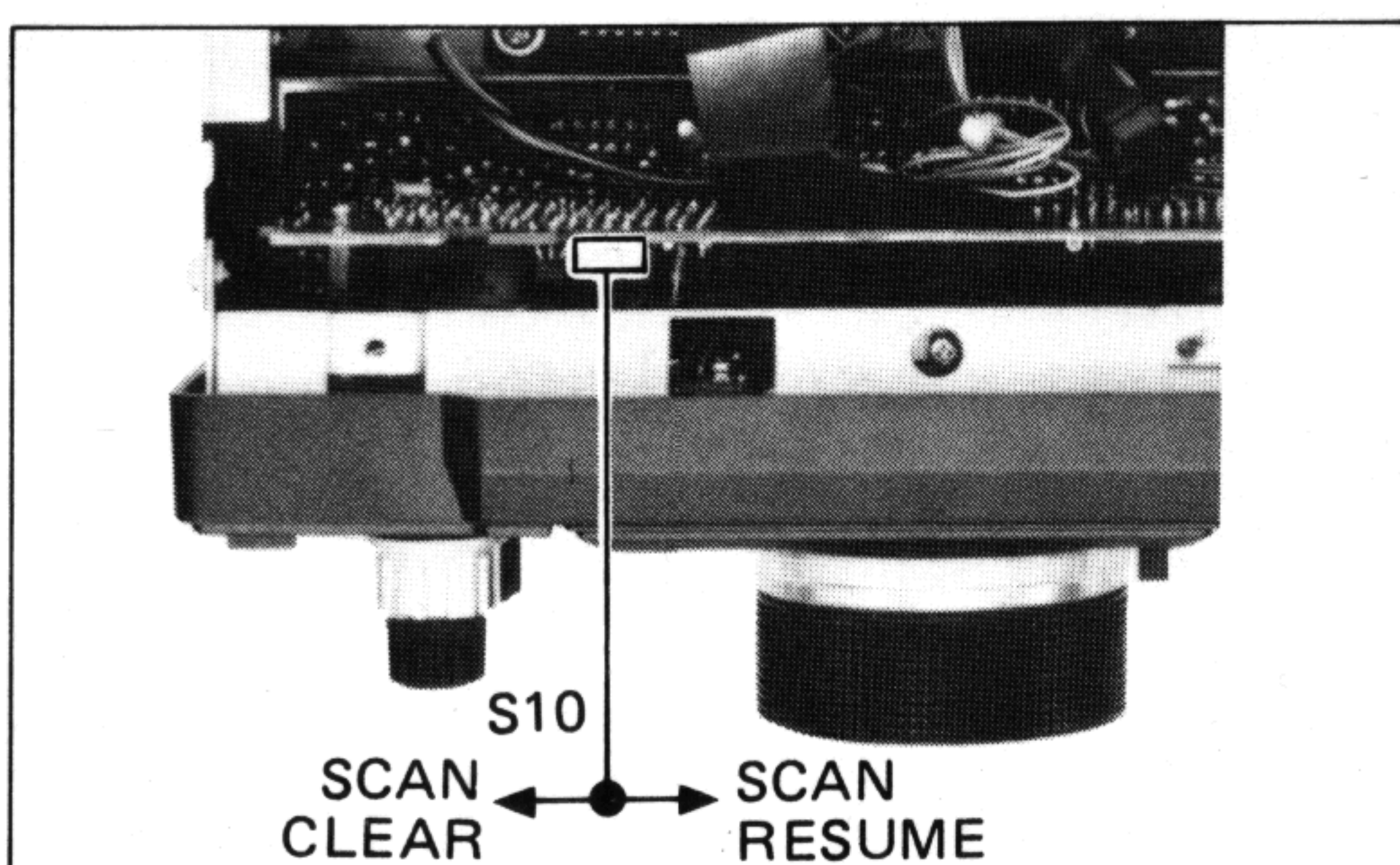

The purpose of this scan is to selectively monitor those memory channels which contain frequencies programmed with the same mode (FM, USB, LSB or CW).

- 1) Push the VFO/MEMORY SWITCH to select the MEMORY CHANNEL mode.
- 2) Adjust the SQUELCH CONTROL to quiet the noise output from the speaker.
- 3) Push IN the MODE SCAN (MODE-S) SWITCH.
- 4) Push the SCAN SWITCH.

The transceiver begins from the channel selected in step 1), and steps through each memory channel with the same mode, stopping only when a receive signal is detected.

The purpose of this scanning function is to monitor a particular section of the band.

- 1) Store the frequencies of the high and low limits of the desired scanning range in memory channels 01 and 02. See SECTION 8 - 2 PROGRAMMING MEMORY CHANNELS, if necessary, for instructions on how to write frequencies into memory channels. The scan begins from the high limit of the range regardless of which channel has the higher frequency stored.

- 2) Use the VFO A/B SWITCH to select the VFO you wish to use.
- 3) Adjust the SQUELCH CONTROL to quiet the noise output from the speaker.

**NOTE:** If the RECEIVE INDICATOR remains ON, for example if the SQUELCH CONTROL is rotated fully counter-clockwise, the scan will not stop at any signals.

- 4) Push the SCAN SWITCH to start the scan. The transceiver scans from the high limit towards the low limit. The scanning rate depends on the TUNING SPEED SWITCH position.
- 5) The squelch opens when a signal is received. This stops the scan automatically if the SQUELCH CONTROL has been set as explained in step 3). After approximately 10 seconds, the scan resumes downwards from the frequency on which it stopped.
- 6) Pushing the SCAN SWITCH while the scan is operating, or during the 10 second halt period, clears the scanning function. Transmitting or rotating the TUNING CONTROL also cancels the scanning function.

After stopping due to a received signal, all scans resume after a fixed time of approximately 10 seconds. However, switch S10 may be used to override this feature.

The factory setting is the SCAN RESUME position. When placed in the SCAN CLEAR position, the scan function automatically clears when a receive signal opens the squelch circuit. To continue scanning, push the SCAN SWITCH again.

## SECTION 9 OTHER FUNCTIONS

### 9 - 1 VSWR READINGS

The IC-751A has a built-in VSWR meter to check antenna matching as an aid in avoiding problems caused by high VSWR.

- 1) Set the METER SWITCH to "Po".
- 2) Select the RTTY operating mode.
- 3) Place the TRANSMIT/RECEIVE SWITCH at TRANSMIT.
- 4) Adjust the RF POWER CONTROL located on the front panel to place the meter needle at "SET" on the SWR scale.
- 5) Set the METER SWITCH to "SWR". Read the VSWR from the SWR scale.

**NOTE:** Always use a 50 ohm antenna system in order to obtain full output power and to avoid possible damage to the transmitter.

### 9 - 2 WWV/WWVH RECEPTION

The signal from radio station WWV or WWVH may be used for alignment of a frequency counter, the marker oscillator or the frequency display.

- 1) Select the 10MHz band using either the HAM BAND or GENERAL COVERAGE mode.
- 2) Push the AM SWITCH.
- 3) Use the TUNING CONTROL to select 10.000.0MHz.

Reception of WWV/WWVH is also possible on 2.5, 5 and 15MHz. Use the frequency which has the strongest signal at your location.

## SECTION 10 OPTIONS INSTALLATION

**WARNING:** Disconnect the power cable from the IC-751A before performing any work.

### 10-1 FILTERS

#### ● FILTER CHARACTERISTICS

MODE	FILTER	CHARACTERISTICS		
		Center Frequency	-6dB point	-60dB point
CW/RTTY	FL-52A	455kHz	500Hz	1kHz
CW/RTTY	FL-53A	455kHz	250Hz	480Hz
CW/RTTY	FL-63A	9.0106MHz	250Hz	800Hz
CW/RTTY	*FL-32A	9.0106MHz	500Hz	1.34kHz
SSB	FL-70	9.0115MHz	2.8kHz	5kHz
SSB	*FL-80	9.0115MHz	2.6kHz	3.8kHz
SSB	*FL-44A	455kHz	2.3kHz	4.2kHz
AM	FL-33	9.0100MHz	6kHz	20kHz

**NOTE:** The filters marked with a "\*" are supplied with the IC-751A.

#### ● FILTER COMBINATIONS

MODE	FILTER SWITCH	9MHz FILTER	455kHz FILTER	STANDARD BANDWIDTH	P.B.T.
USB/LSB	OUT	FL-80	FL-44A	2.3kHz	YES
	IN	FL-80	CFJ455K5	2.6kHz	YES
CW/RTTY	OUT	FL-32A	FL-44A	500Hz	YES
	IN	FL-80	FL-44A	2.3kHz	YES
CW/RTTY NARROW	OUT	FL-32A	FL-52A/ FL-53A	500Hz/ 250Hz	YES
	IN	FL-80	FL-52A/ FL-53A	500Hz/ 250Hz	IF SHIFT
AM	OUT	THROUGH	CFW455HT	8kHz	NO
	IN	THROUGH	CFJ455K5	3kHz	NO
FM	OUT	THROUGH	CFW455E	15kHz	NO
	IN	THROUGH	CFW455E	15kHz	NO

#### ● FILTER SYSTEM

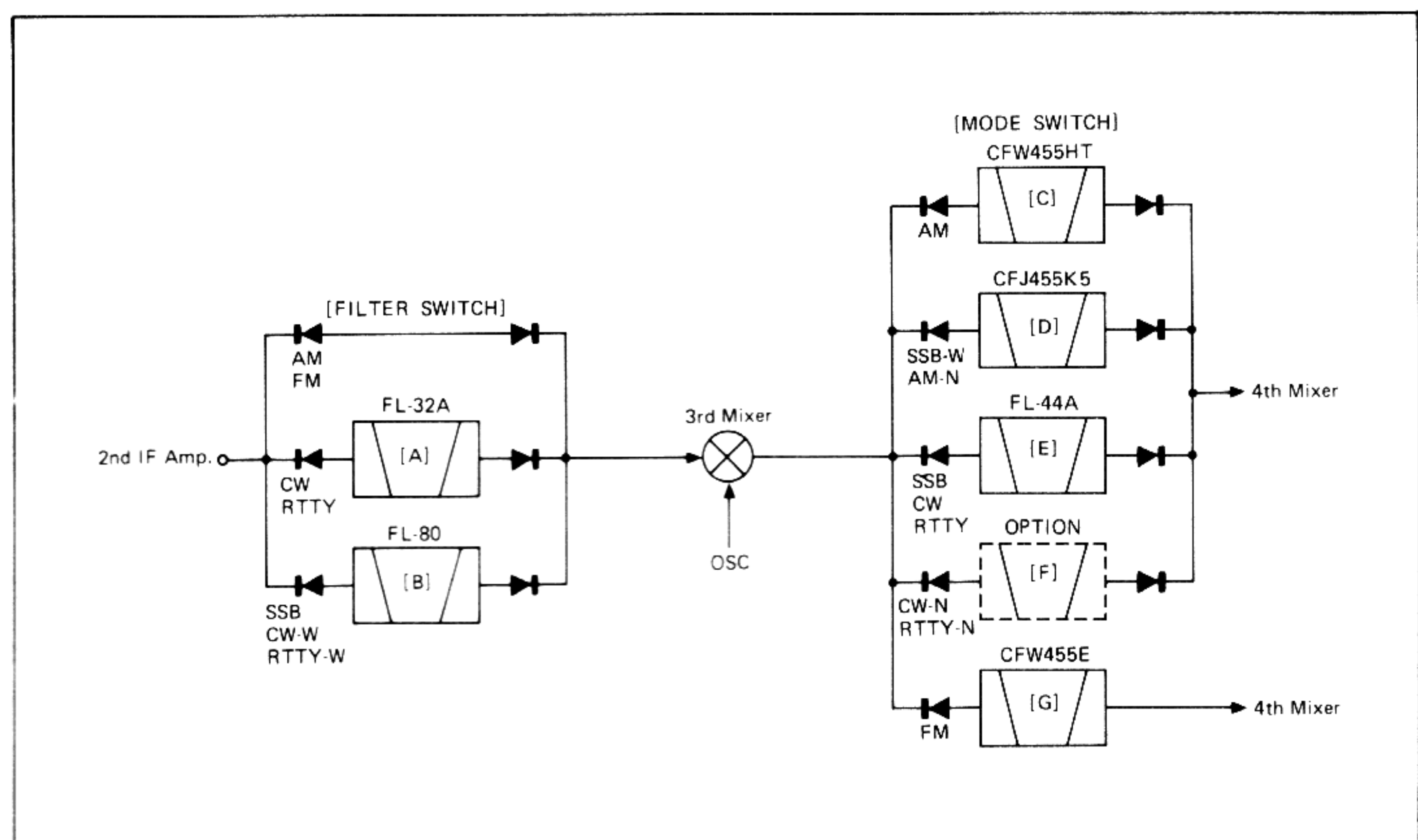
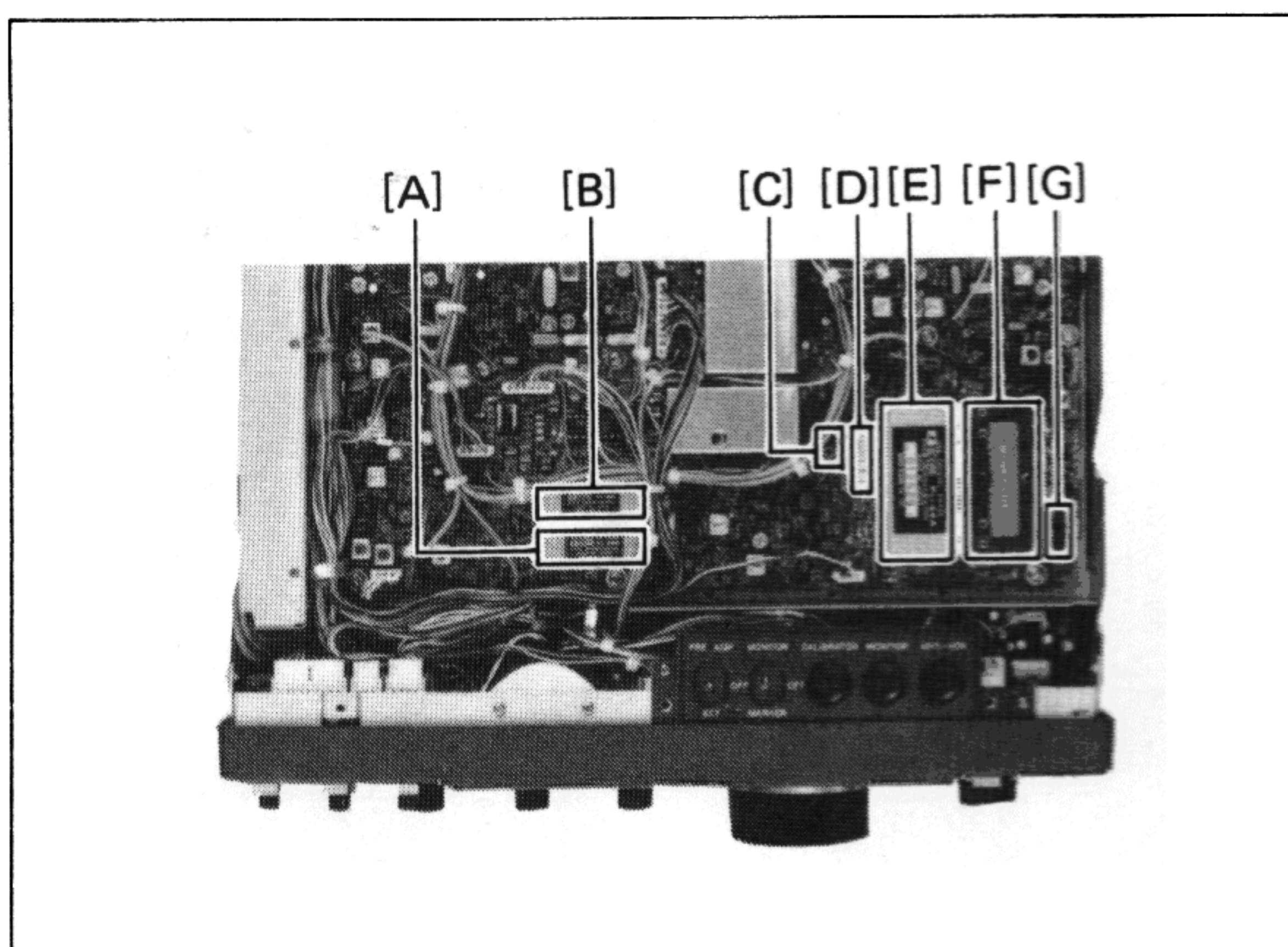

#### ● FILTER REVERSE SWITCHES

The FILTER SWITCH on the front panel of the IC-751A selects between two receive filter systems for the SSB, CW, RTTY or AM mode when it is switched between the IN and OUT positions. The IN/OUT relationship of the FILTER SWITCH may be reversed by using the internal FILTER REVERSE SWITCHES.

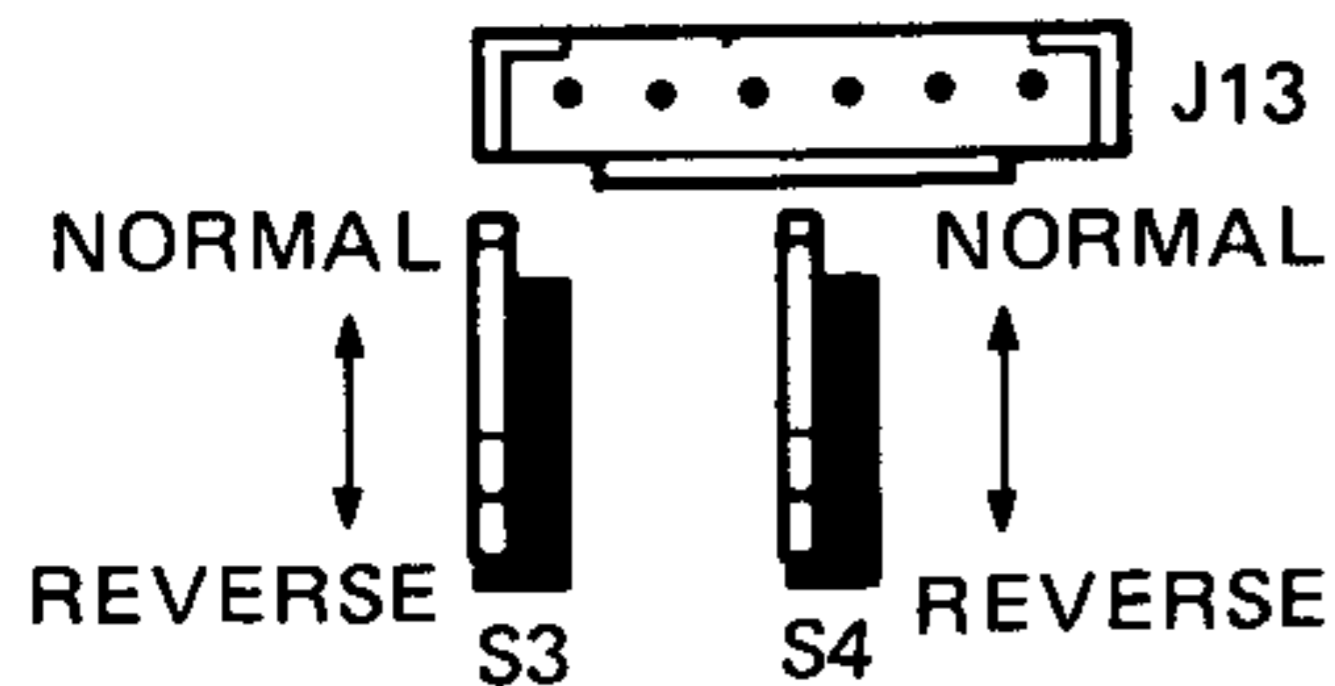

**(1) FL-52A, FL-53A INSTALLATION**

S3: Reverses the IN and OUT positions of the FILTER SWITCH when using the AM mode.

S4: Reverses the IN and OUT positions of the FILTER SWITCH when using the CW or RTTY mode.

These are 455kHz filters for use with the CW NARROW or RTTY NARROW mode.

No special tools are required to successfully complete the installation of these filters. Install them at position [F] in the photo.

- 1) First, remove the top cover.
- 2) Insert the optional FL-52A or FL-53A into position [F] as shown in the photo.
- 3) Check the operation of the filter using the FILTER COMBINATIONS TABLE for a guide. If necessary, refer to SECTION 6 - 4 CW OPERATION for instructions on how to select the CW NARROW and RTTY NARROW modes.

**(2) FL-63A INSTALLATION**

This is a 9MHz narrow filter for the CW or RTTY mode. The filter replaces the standard FL-32A which is supplied with the IC-751A. Install this filter at [A] position.

- 1) Remove the top cover, then the 11 screws from the MAIN unit.
- 2) Lift the right edge of the MAIN unit upwards taking care not to damage the sockets and plugs that are installed on the unit.
- 3) The filter must be installed at position [A] in the photo, therefore remove the FL-32A original filter from the MAIN unit using de-soldering braid.
- 4) Install the FL-63A at position [A]. Orient the label on the filter in the same manner as the other filters already installed.
- 5) Bend the leads and mounting tabs flush against the opposite side of the printed circuit board, and solder. Trim the ends of the leads with diagonal cutters.
- 6) Replace the MAIN unit and screws, and the top cover.

There are no adjustments required after installation is completed.

**(3) FL-70 INSTALLATION**

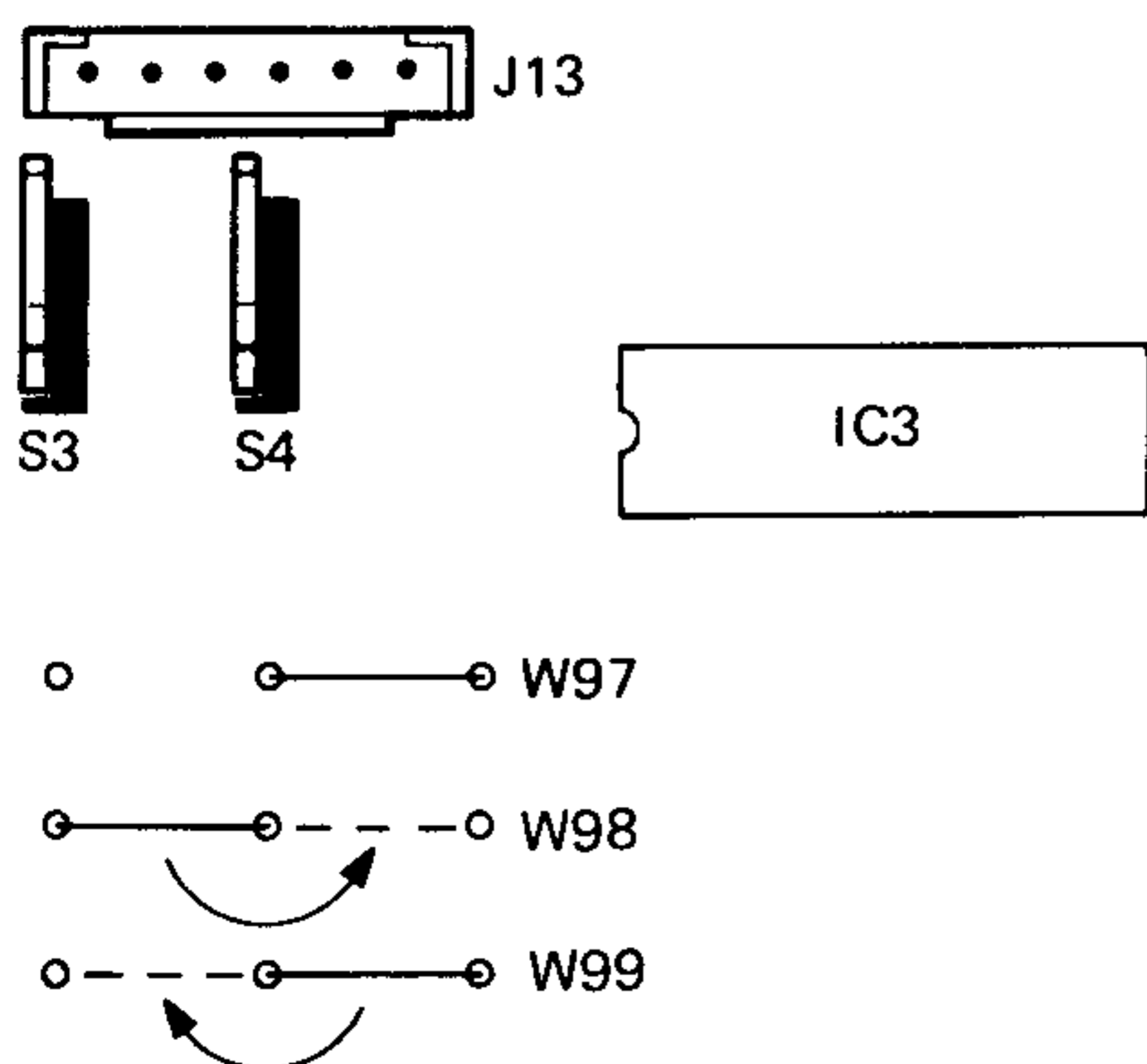

This is a 9MHz wide filter for SSB which may be installed in one of two ways:

a) To replace the standard FL-80 with the FL-70.

b) To replace the standard FL-32A with the FL-70.

a: Use the FL-63A installation method given previously. Place the FL-70 in the position where the FL-80 is now installed.

b: 1) Use the FL-63A installation method given previously. Place the FL-70 in the position where the FL-32A is now installed.

2) The FL-70 operates only on CW or RTTY if it is installed in the FL-32A location.

Therefore, perform the following modification so the FL-70 may or may not be used as desired.

3) W98 and W99 jumper wires on the MAIN unit must be changed as shown in the diagram on page 45.

4) The FL-70 and the CFJ455K5 can now be selected by pushing the FILTER SWITCH on the front panel IN. The receive bandwidth will be 2.8kHz.

The FL-80 and FL-44A can be selected by placing the FILTER SWITCH at the OUT position. The bandwidth will then be 2.3kHz.

This is a 9MHz filter for the AM mode. The filter replaces the FL-32A and requires the relocation of jumper wires.

#### (4) FL-33 INSTALLATION

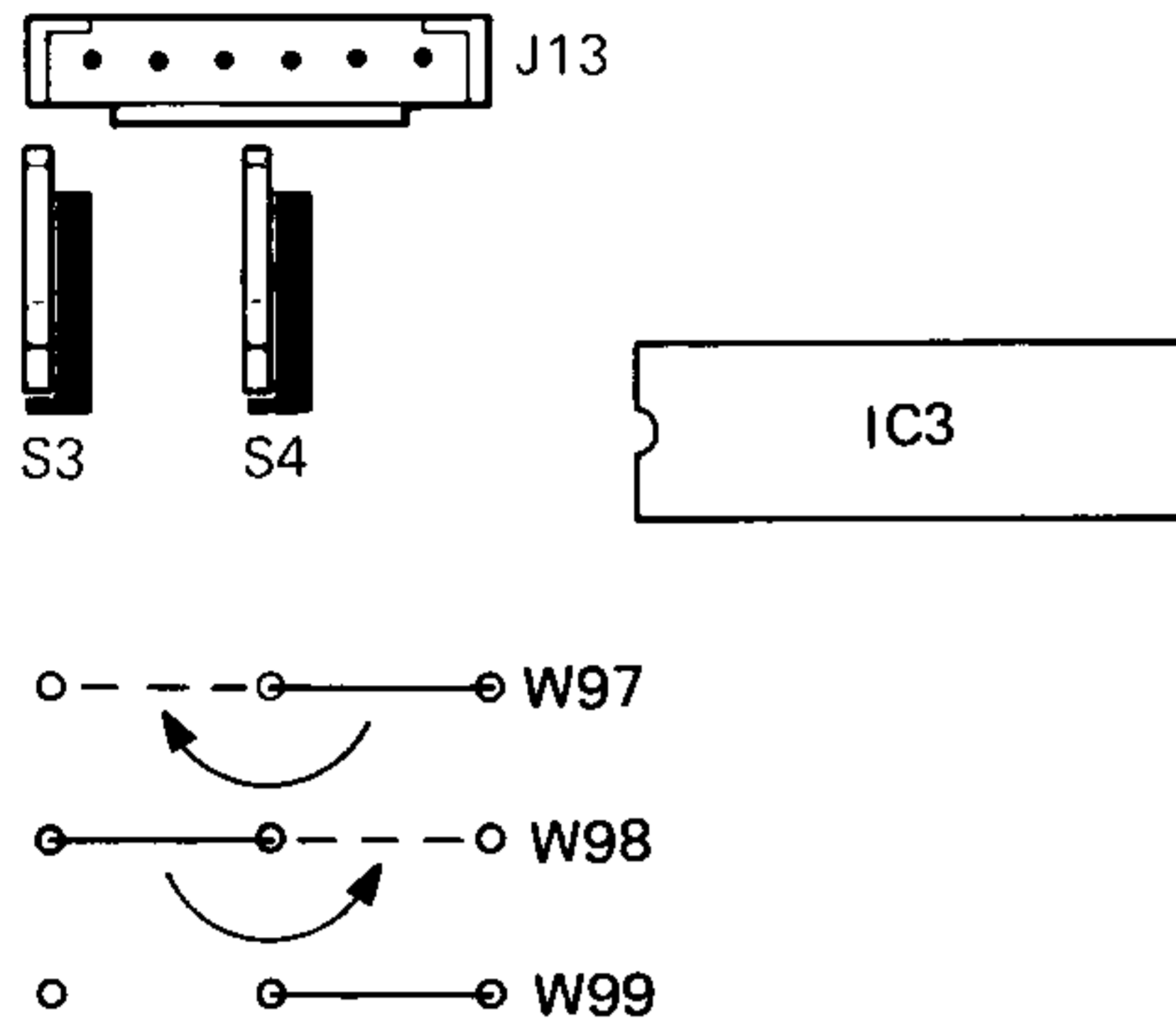

#### 10 - 2 IC-PS35 INTERNAL POWER SUPPLY

##### ●INSTALLATION

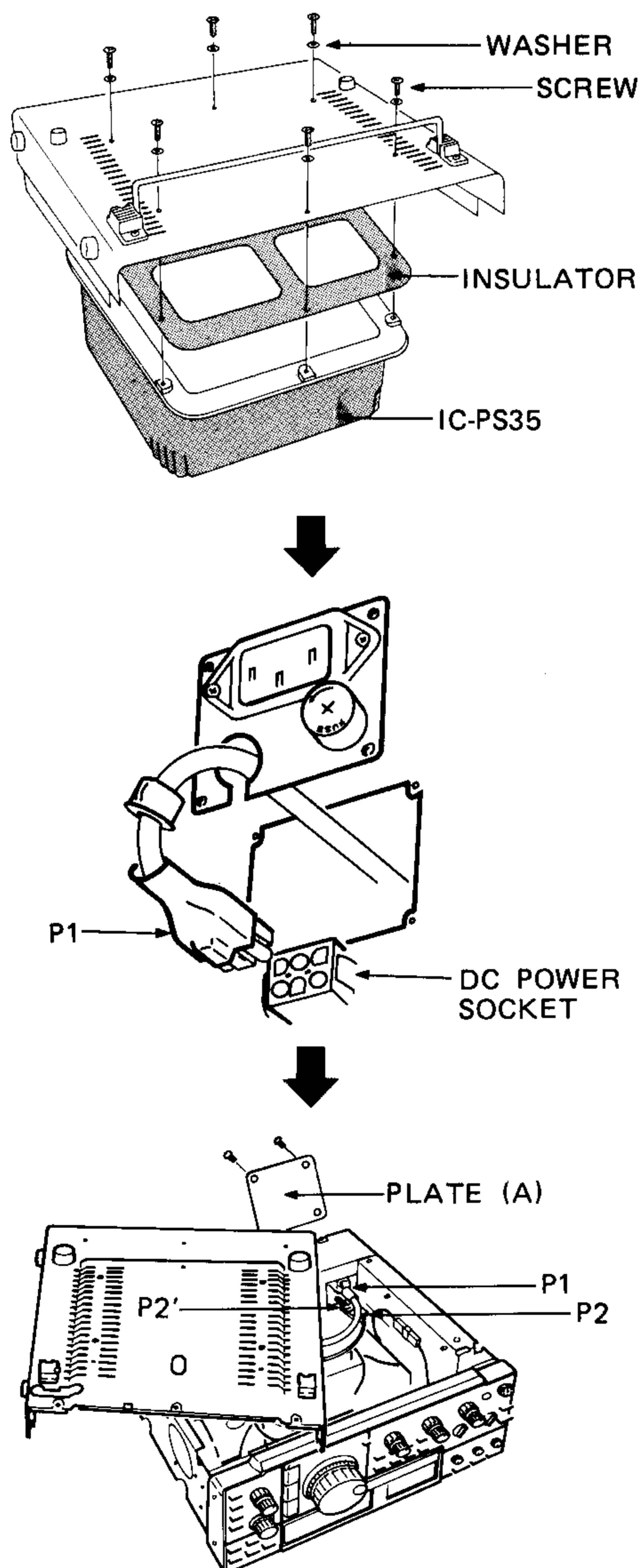

1) Use the FL-63A installation method given previously. Install where the FL-32A is now installed.

2) Change the jumper wires as shown in the diagram.

3) This installation causes the FL-33 to be selected whether the FILTER SWITCH is at the IN or OUT position when using the AM mode. Only 455kHz filters will be changed by the FILTER SWITCH.

**WARNING:** Disconnect the power cable from the IC-751A before performing any work.

1) Turn the transceiver upside down. Remove PLATE (A) attached to the rear panel by unscrewing the four screws. These screws will be used later.

2) Attach the IC-PS35 to the bottom cover with the supplied screws and insulating washers. Also insert the insulating gasket between the IC-PS35 and the bottom cover.

3) Pass the DC power cable attached to P1 through the hole of the AC power socket plate as shown in the illustration, then insert the bushing into the hole.

Attach the AC power socket plate to the PLATE (A) position using the screws which previously held PLATE (A). The AC power socket should be towards the bottom of the transceiver.

4) Pass the P2' connector from the power socket unit to the inner chassis through the hole in the rear chassis. Connect this P2' connector with the P2 connector from the IC-PS35.

5) Position the cables in the rear chassis. This prevents magnetic coupling between the cables and the VCO coil cores.

6) Replace the top and bottom covers of the transceiver. Plug P1 from the IC-PS35 into the DC Power Socket on the transceiver.

7) Connect the supplied AC power cable into the newly installed AC power socket on the rear panel of the IC-751A. Connect the AC power plug into an AC power outlet.

8) Push the IC-751A POWER SWITCH to apply power to the transceiver.

### 10 - 3 IC-EX310 VOICE SYNTHESIZER UNIT

#### ●INSTALLATION

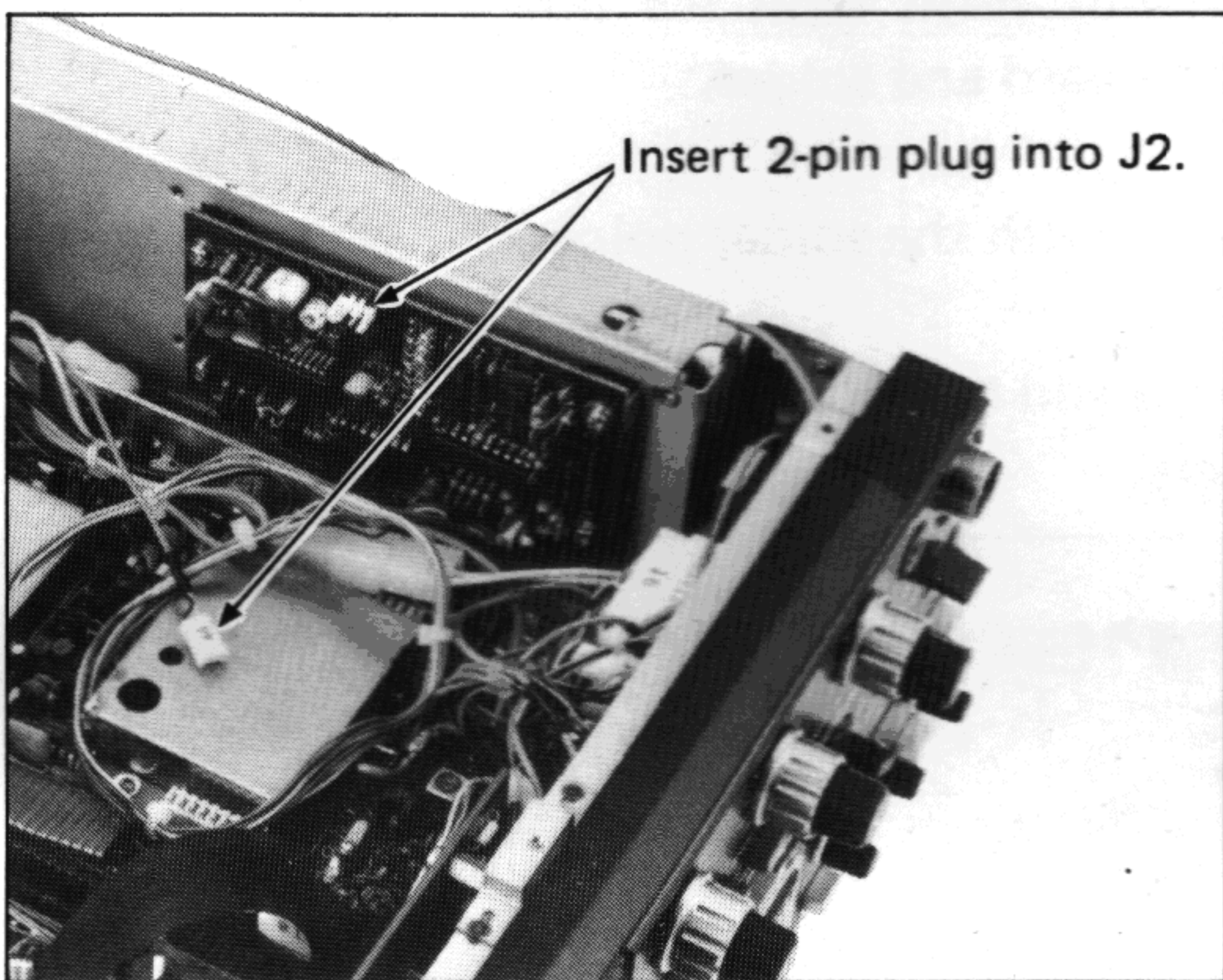

After being installed, the voice synthesizer announces the displayed frequency when the SPEECH SWITCH on the front panel is pushed.

- 1) Turn the transceiver upside down.
- 2) Install the IC-EX310 unit as shown in the photo using the four supplied screws. Insert the 2-pin plug shown in the photo into J2 of the IC-EX310 unit.
- 3) Plug the 8-pin plug from the IC-EX310 into J12 on the LOGIC unit.
- 4) Adjust the volume and speech speed if necessary. The procedure is described below.
- 5) Replace the top and bottom covers on the IC-751A.

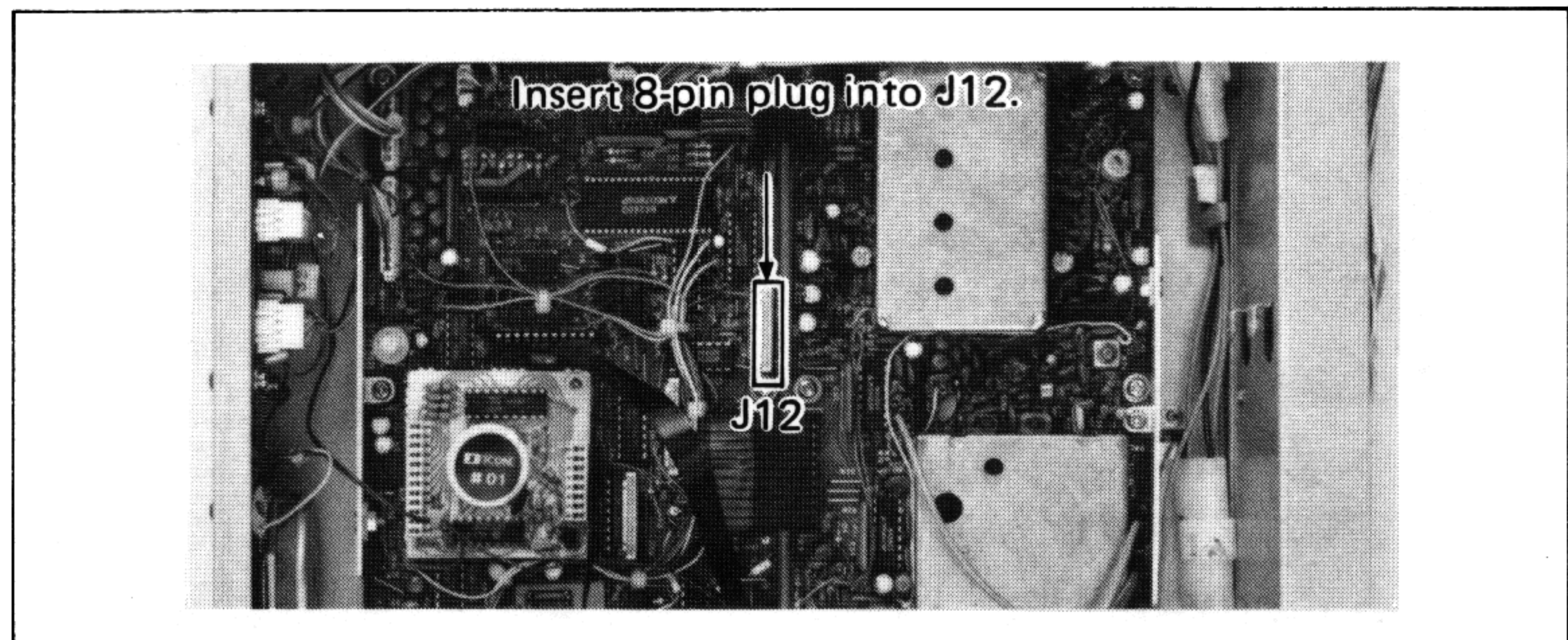

#### ●ADJUSTMENT

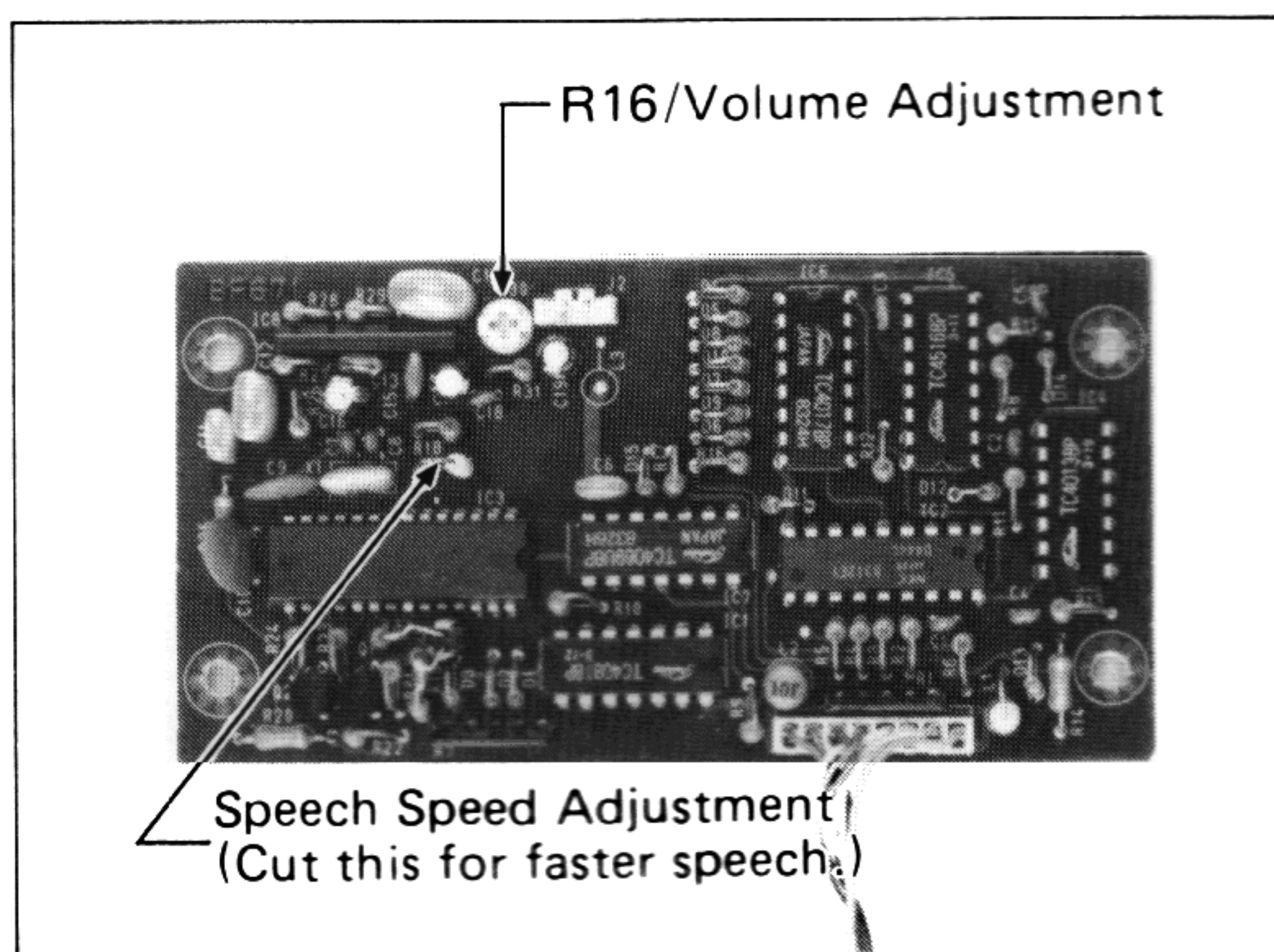

- 1) Adjust the speech volume and speech speed, if necessary, before the top and bottom covers are replaced.
- 2) Connect a power source to the transceiver and turn ON the POWER SWITCH. Push the SPEECH SWITCH on the transceiver to have the displayed frequency announced in English.
- 3) The volume of the announcement is adjustable with R16 on the voice synthesizer. Adjust R16 for a comfortable audio level.
- 4) The W1 jumper wire controls the speech speed. Cut W1 to increase the speech speed.
- 5) Replace the top and bottom covers of the transceiver when adjustments are completed.

### 10 - 4 CR-64 HIGH-STABILITY CRYSTAL UNIT

#### ●INSTALLATION

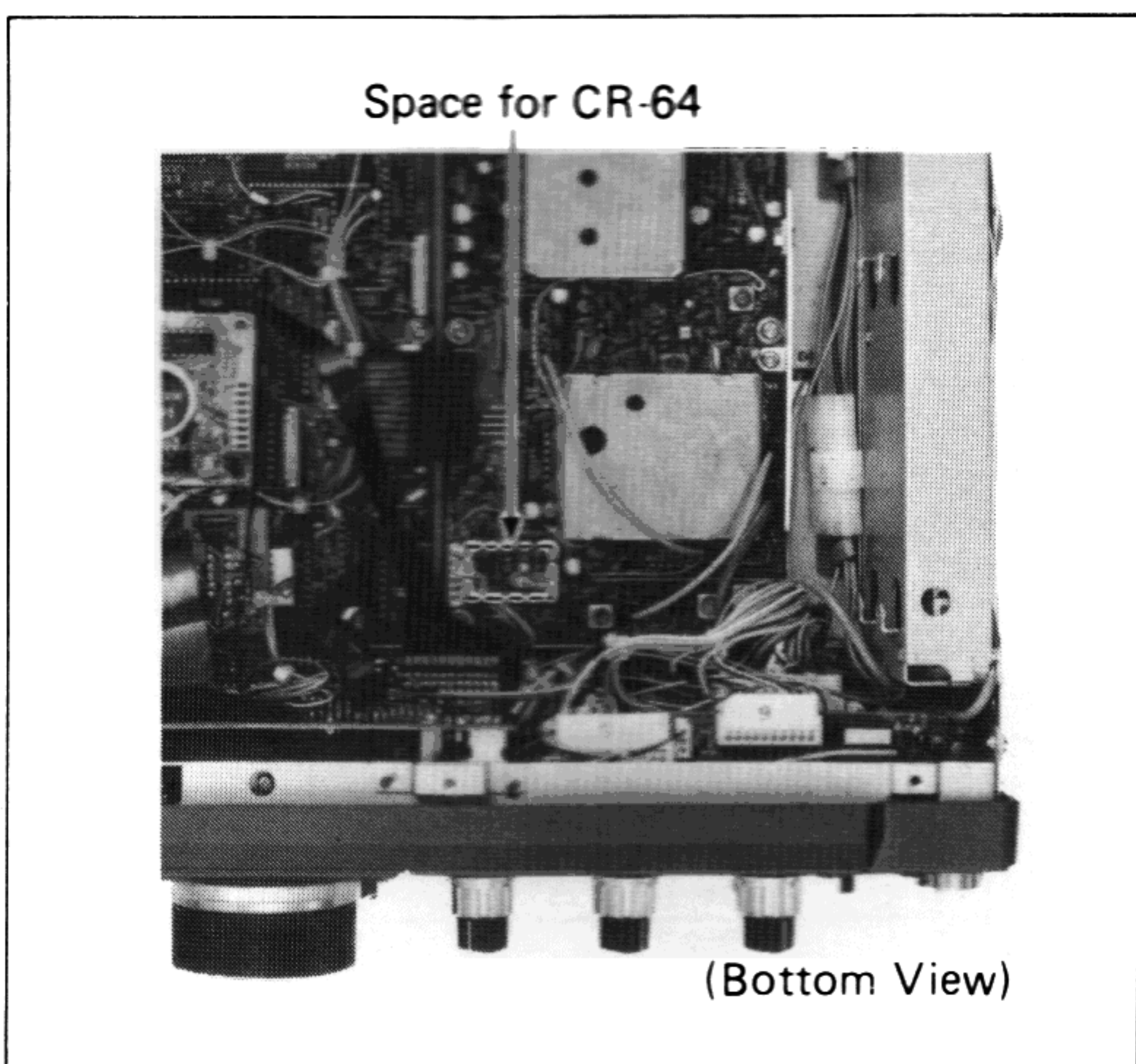

- 1) Turn the transceiver upside down.
- 2) Unscrew the six screws retaining the PLL board. Unplug the connectors indicated in the photo, then turn the board over to view the printed circuit side.
- 3) Using de-soldering braid, remove the solder from the original crystal unit terminals and grounding lead. Remove the original crystal unit and grounding lead from the board.
- 4) The mounting location for the high-stability crystal unit is shown in the photo. The holes for the unit terminals are predrilled. If the holes are filled with solder, remove the solder using desoldering braid.

- 5) Orient the unit so that the crystal and heater terminals are inserted into the correct holes as indicated in the photo. The terminals are labelled on the bottom of the unit.

Position the crystal unit flush with the board, bend the leads against the foil on the board and solder.

- 6) Trim the terminals even with the solder points.

- 7) Replace the PLL board and re-install the connectors. Replace the top and bottom covers.

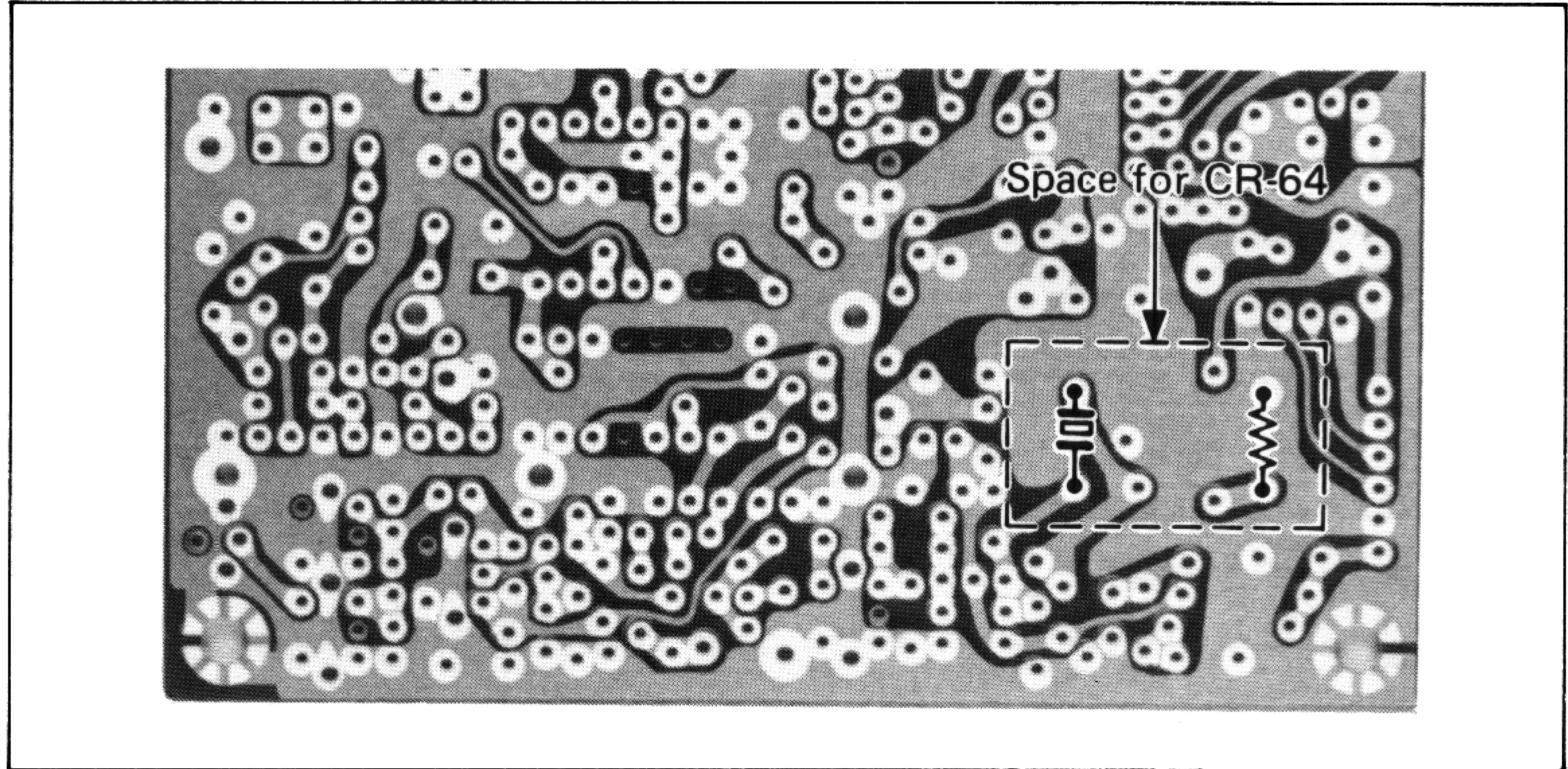

## 10 - 5 UT-30 PROGRAMMABLE ENCODER UNIT

### ●INSTALLATION

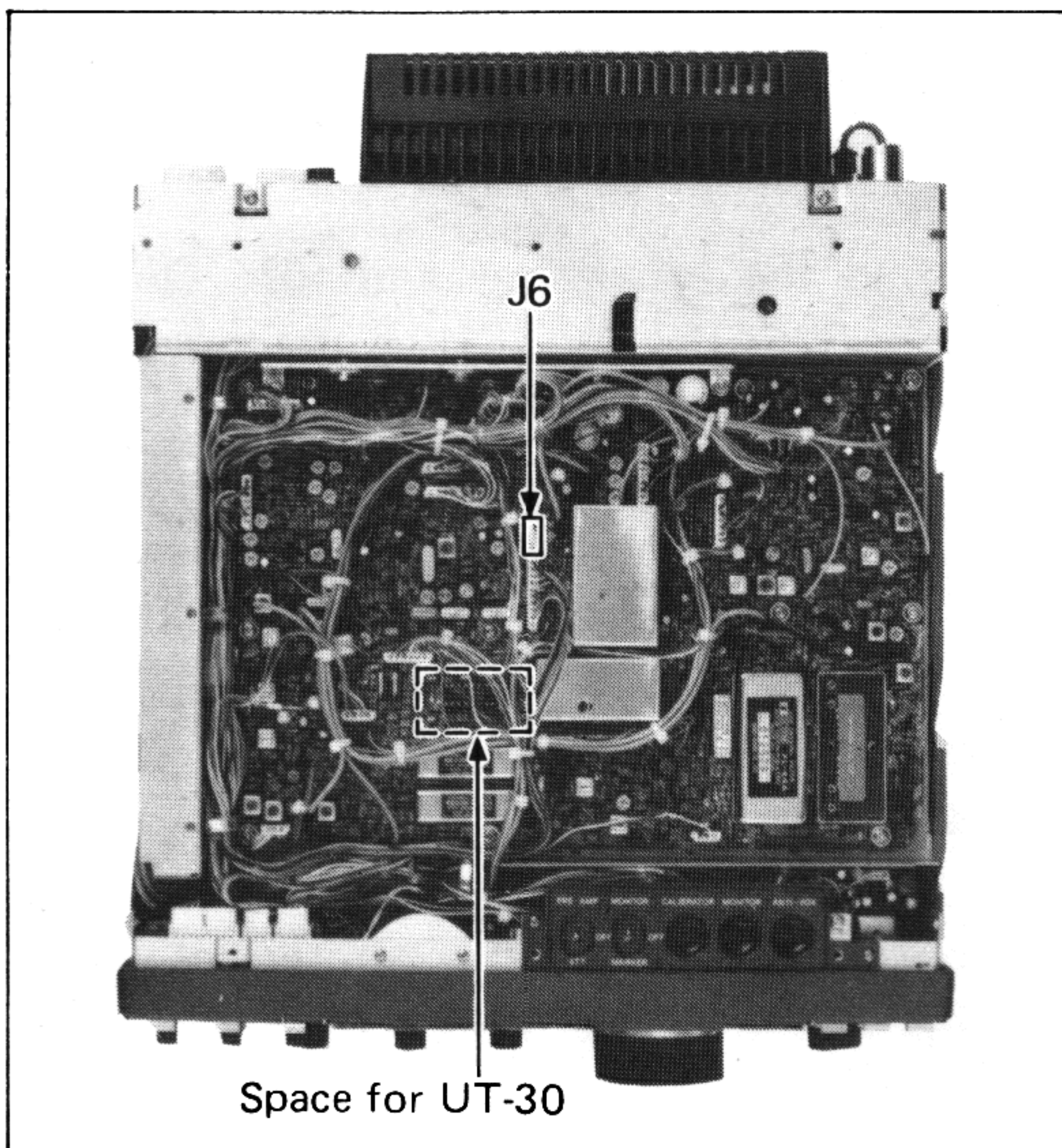

- 1) Remove the top cover.

- 2) Install the unit where IC3 is located using the supplied double-sided tape.

Orient the unit as shown in the diagram.

- 3) Plug the 3-pin connector into J6 on the MAIN unit.

- 4) Program the unit for the frequency required using the programming chart. The UT-30 is factory programmed for 88.5Hz.

- 5) Replace the transceiver cover.

Refer to SECTION 7 - 6 FM REPEATER OPERATION for instructions regarding operation.

**NOTE:** Install and solder a jumper wire in each position indicated by "1" in the table below.

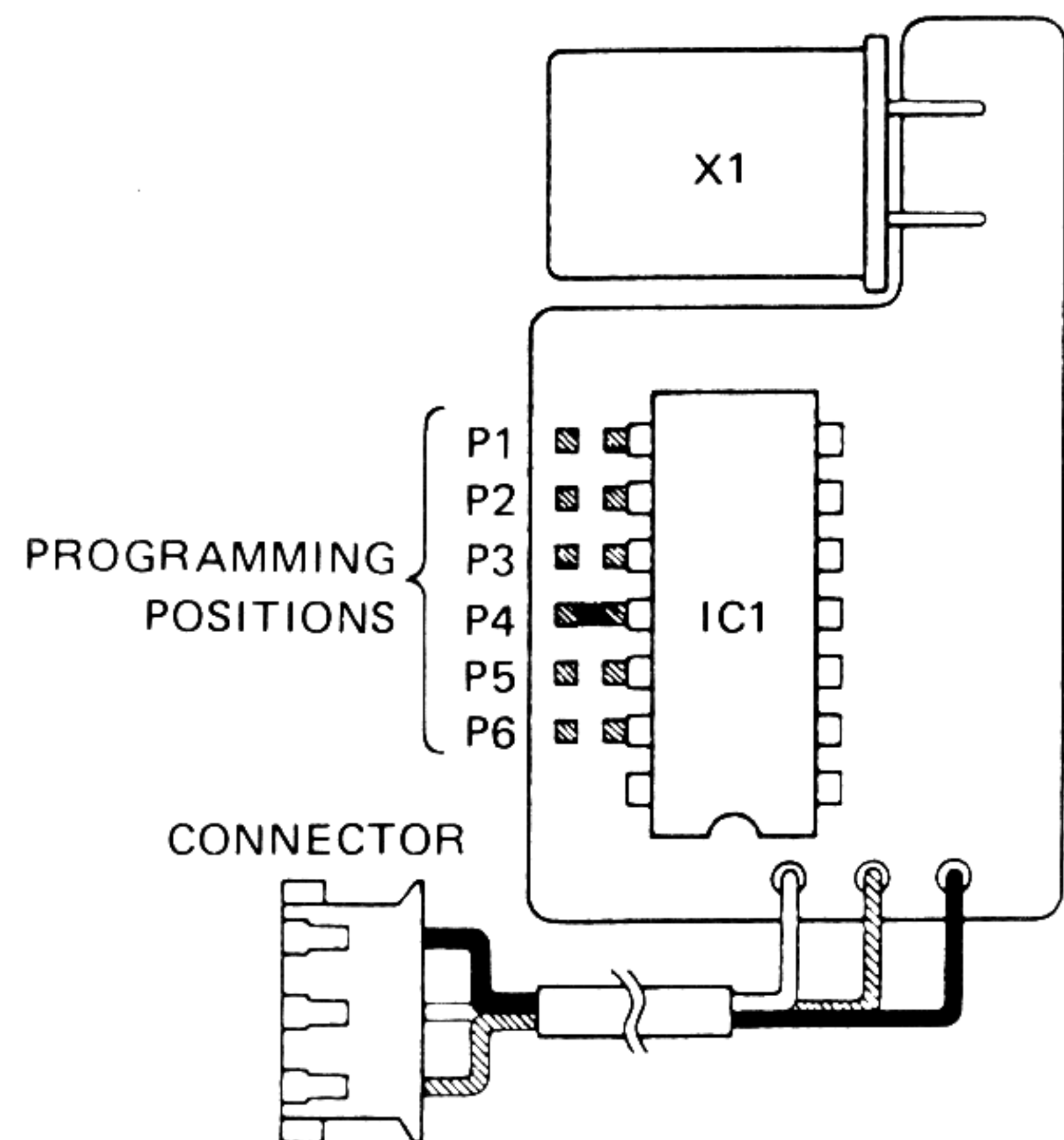

● Above unit is programmed for an 88.5Hz tone at the factory.

SUBAUDIBLE TONE ENCODER PROGRAMMING CHART

FRE-QUENCY	P1	P2	P3	P4	P5	P6	FRE-QUENCY	P1	P2	P3	P4	P5	P6
67.0	1						131.8			1		1	
71.9		1					136.5	1		1		1	
74.4	1	1					141.3		1	1		1	
77.0			1				146.2	1	1	1		1	
79.7	1		1				151.4				1	1	
82.5		1	1				156.7	1			1	1	
85.4	1	1	1				162.2		1		1	1	
88.5				1			167.9	1	1		1	1	
91.5	1			1			173.8			1	1	1	
94.8		1		1			179.9	1		1	1	1	
97.4	1	1		1			186.2		1	1	1	1	
100.0			1	1			192.8	1	1	1	1	1	
103.5	1		1	1			203.5						1
107.2		1	1	1			210.7	1					1
110.9	1	1	1	1			218.1		1				1
114.8					1		225.7	1	1				1
118.8	1				1		233.6			1			1
123.0		1			1		241.8	1		1			1
127.3	1	1			1		250.3		1	1			1



## SECTION 11 CIRCUIT DESCRIPTION

### 11-1 RECEIVE CIRCUITS

#### (1) RF CIRCUITS

##### ●RF UNIT

The receive signal from the antenna connector is fed to J10 of the RF unit in the receiver circuit when D4 is turned OFF and RL1 on the CONNECTOR unit is turned ON.

The incoming signal to the RF unit passes through an "L" attenuator, consisting of R92 and R93 on the RF unit, for 20dB of attenuation when the PREAMP/ATT SWITCH is set to the ATT position.

The BPF switching voltage is obtained with IC1 and IC2 by decoding the B1 ~ B11 band signals from the LOGIC unit.

The ON/OFF switching voltage is provided by IC2. R13V is provided from the OR gate consisting of D5 and D6. The attack time of this control voltage is determined by R9 and R10. The immediate release is provided by D1 and D2 when switching to the transmit mode.

#### (2) IF CIRCUITS

##### ●RF UNIT

Q9 and Q10 comprise a double-balanced mixer using low-noise 2SK125 J-FETs. The mixer, driven with 13.8V, provides an excellent noise figure and converts the incoming signal to the 70.4515MHz first IF signal.

The first LO output signal from the PLL unit is fed through a high-pass filter, is amplified by Q2, is filtered by a low-pass filter, and then is applied to the first mixer as its local oscillator signal (70.5515 ~ 100.4515MHz). R18, L13 and C14 are for feedback to improve the frequency characteristics of Q2.

The first IF signal is filtered by the F11 monolithic crystal filter ( $\pm 7.5\text{kHz}/-3\text{dB}$ ) and is then amplified by the Q8 dual-gate FET. The second gate of Q8 is controlled by the AGC voltage.

The signal is fed through the D19 T/R switching diode and a high-pass filter to the second IF mixer of the IC3 double-balanced mixer where the signal is converted to the 9.0115MHz second IF signal. The signal is then filtered by a low-pass filter to remove the local oscillator components and is fed to the MAIN unit through P3.

The second LO signal (61.44MHz) from the PLL unit is fed to IC3 as the local oscillator signal for the second mixer.

##### ●MAIN UNIT

The IF signal from the RF unit passes through a noise blanker circuit, and is supplied to a 9MHz filter through the Q33 amplifier. The signals always are passed through the noise blanker which is controlled by a noise blanker gate consisting of D68 ~ D71 called a double-balanced diode switch. If the noise blanker detects pulse noise, the blanker puts out a control voltage via D72 which momentarily cuts off the signal.

The 9MHz filter circuit consists of F12, F18 and a bypass circuit. The signal from the filter circuit is supplied to the IC10 mixer through the Q84 buffer amplifier, and is converted to a 455kHz signal. The signal is then fed through Q39 to a 455kHz filter circuit consisting of F13, F14, F15, F16 and an optional filter.

The output from the filter is converted to a 9MHz signal again by the IC11 mixer through the Q42 buffer amplifier. FM signals from the FI6 filter are fed to a special FM circuit. The 9MHz signal is supplied to an amplifier circuit consisting of Q43 and Q44, then is supplied to the AGC or the DETECTOR circuit. Finally, the signal is fed to the AF amplifier circuit.

FM signals from FI6 are supplied to amplifier and limiter circuits consisting of IC12, Q45 and IC13. The limiter circuit eliminates noise or AM components, then the signal is supplied to a frequency discriminator and is detected. The detected signal passes through a C-R network for de-emphasis and is supplied to the AF amplifier circuit.

The AF amplifier circuit consists of a pre-amplifier and an AF power amplifier which amplifies the signal to a sufficient level to drive a speaker.

A switching circuit consisting of Q74 and Q75 is installed at both the input and output of the pre-amplifier circuit in order to cut off the AF signal by means of a squelch signal. The output from the pre-amplifier is also supplied to the ACC socket on the rear panel.

The AF signal from the detector circuit is amplified by IC19 (b). Then it is fed to the IC19 (a) pre-amplifier through the TONE CONTROL circuit consisting of R394, C258 and the TONE CONTROL on the front panel. The signal is supplied to the IC18 AF power amplifier through the AF GAIN CONTROL on the front panel. The AF power amplifier has a 2.6W output capability under an 8 ohm load with 10% distortion.

## 11 - 2 TRANSMIT CIRCUITS

### (1) AF CIRCUITS

#### ●MAIN UNIT

The AF signal from the mic connector is fed through the MIC GAIN CONTROL on the front panel to Q34 and Q35 where the signal is amplified. The tone control circuit is installed between Q34 and Q35, and varies the frequency response of the mic amplifier. The signal is also supplied to the ACC socket through R148 and C83.

IC9 is a double-balanced mixer which generates the SSB and AM signals. IC9 puts out DSB signals formed by the AF signal mixing with the BFO signal. In the AM mode, an offset voltage is fed to the modulating input terminal of IC9 through R159 and D75 so the carrier level may be controlled by simply adjusting the offset voltage.

#### ●RF COMPRESSOR

The DSB or AM signal from IC9 is fed to the 9MHz filter and the filter eliminates one sideband resulting in an SSB signal. The signals are fed through Q84 to the IC10 mixer. IC10 puts out a 455kHz signal which is fed to the Q38 matching amplifier through the Speech Compressor circuit when the circuit is turned ON. Then the signal is converted to 9MHz again, and is fed to the transmitter IF amplifier by Q1.

#### ●RF UNIT

The 9.0115MHz IF signal from the MAIN unit passes through the LPF and is converted to 70.4515MHz by the IC3 double-balanced mixer. The HPF eliminates the 9.0115MHz signal component from the mixer output signal, and the L30 and C67 resonator eliminate the 61.44MHz 2nd LO signal component. The signal is amplified by the Q11 dual-gate FET which receives an ALC voltage at its 1st gate.

The amplified signal is fed through a double-tuned filter composed of L32, C77 and L33 to eliminate spurious components, and then fed to the Q12 and Q13 transmit mixer. The frequency of the local oscillator ranges from 70.5515 ~ 100.4515MHz which converts the IF signal to the desired frequency of 0.1 ~ 30MHz.

In the transmit mode, D45 is turned ON and the signal is amplified about 20dB by the Q14 wideband amplifier and is output to the PA unit through J8. C171 and R86 are provided to tailor the frequency characteristics.

**(2) PA CIRCUITS**

The RF signal input from the RF unit through P1 is amplified by the Q1 class A amplifier. The output from Q1 is converted to a balanced output by L1 and is amplified by the Q2 and Q3 class AB push-pull amplifier. The negative feedback circuits inserted between the collector and the base of Q2 and Q3 provide wide frequency characteristics. The idling current of Q2 and Q3 is controlled by the junction voltage of D1. The current is set at about 100mA by R27, R30 prevents the set value from deviating due to variations of D1 characteristics.

The output of Q2 and Q3 is fed to the L4 impedance matching section and is amplified by the Q4 and Q5 class AB push-pull amplifier to provide 100 watts output power.

**11 - 3 PLL CIRCUITS**

The PLL unit outputs two oscillator signals for the RF unit, i.e., the variable first local oscillator output (1st LO) of 70.55 ~ 100.45MHz necessary for the first mixer, and the fixed local oscillator output (2nd LO) of 61.44MHz necessary for the second mixer. In addition, the marker signal is also generated in this unit and is sent to the RF unit.

**●PLL IC CHIP**

IC1 (M54929P) is a multi-function IC containing a phase comparator, a programmable divider, a reference frequency oscillator circuit, a divider and a swallow counter controller. By using this IC with IC2 (M54466L, a swallow counter), it can perform pulse swallow dividing.

**[MAIN LOOP]**

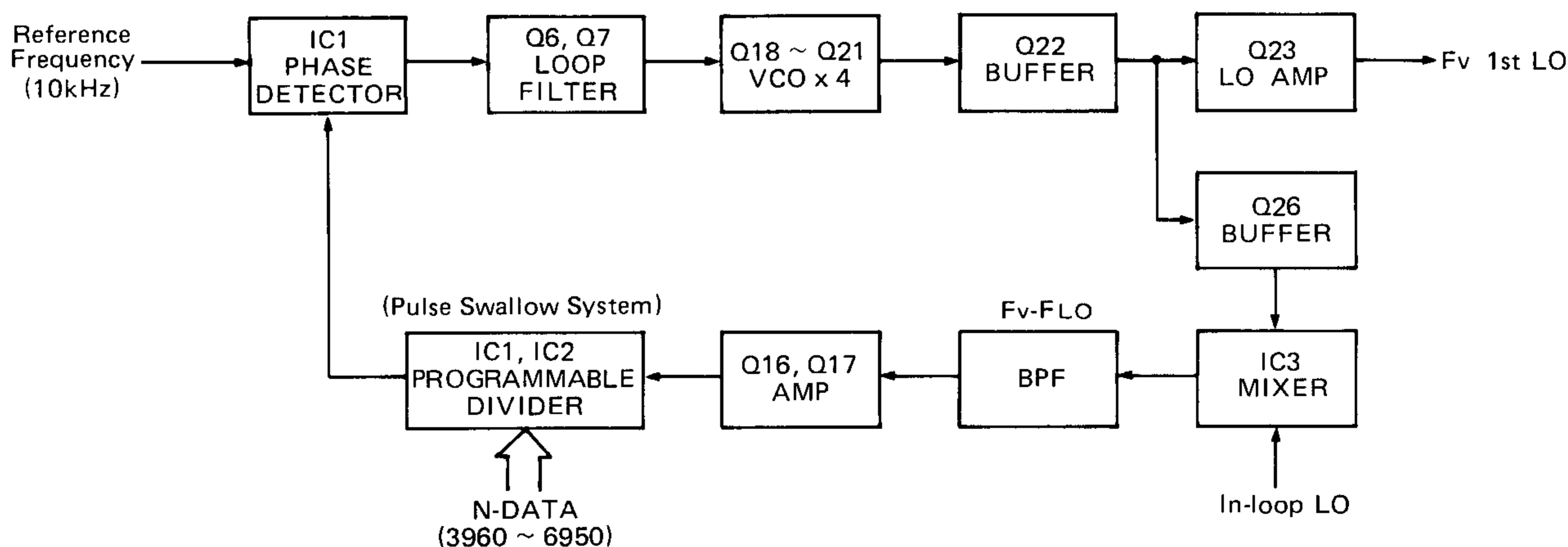

**[MARKER GENERATOR]**

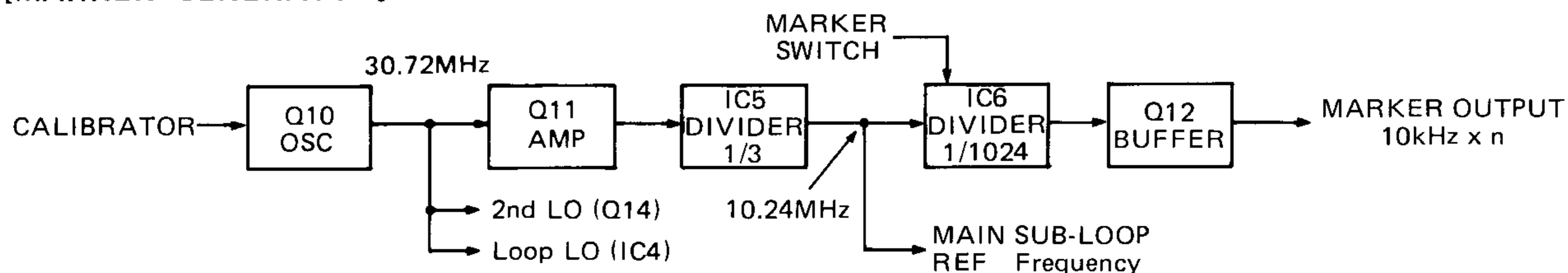

## ●VCO CIRCUIT

The performance of the VCO is very important for PLL operation. In order to obtain a high carrier-to-noise (C/N) ratio and a stable oscillator output, four separate VCOs are used. Each is assigned a quarter of the total necessary bandwidth.

The power supply for the VCOs is doubly regulated when compared with the reference frequency oscillator. Furthermore, coreless coils are used for the oscillator coils in order to obtain a high Q as well as immunity from external induction.

## ●LOOP SYSTEM

The output of the VCO is separated into two parts after passing through the Q22 buffer amplifier. One part is amplified by Q23, and after impedance matching by Q25, is output to the RF unit as the 1st LO. The output level is about 0dBm/50ohms. The other part is fed back to the PLL loop through the Q26 buffer amplifier.

The VCO signal is then mixed with the in-loop LO by IC3 to be down-mixed. The output from the mixer is passed through the bandpass filter with a bandwidth of about 40 to 70MHz to eliminate the spurious components. The output is then amplified by the Q16 and Q17 cascade amplifier, and input to IC2 to form the PLL.

## 11 - 4 LOGIC CIRCUITS

The functions of this unit include the control of frequency, the processing of BPF, LPF and mode signals, the output of data for the PLL unit and display unit, etc. This unit includes an 8-bit NMOS CPU, a 4-bit 1k word CMOS RAM, a multi-purpose custom IC and I/O expander IC's.

### (1) CPU INPUT CONTROL CIRCUIT

A multi-function CMOS IC is used. This custom IC is contained in a 40-pin DIL package.

- (a) An external L and C are connected to pins 18 and 19 to give an approximate clock signal of 100kHz.
- (b) ATS from pin 32 is HIGH if the TUNING CONTROL is rotated faster than a set speed. The set speed is fixed by the values of C6 and R7 connected to pin 21 (TC). The high level is used as a strobe signal which switches the dial-pitch (tuning rate) of the matrix input.
- (c) M1 and M2 at pins 38 and 37 are used to switch the multiplication factors of the input pulses from the TUNING CONTROL. 200 pulses per one rotation are obtained by 50 pulses x 4. For RIT/ $\Delta$ TX control, the multiplication factor is two times to give 50 pulses x 2 = 100 pulses per one rotation.

### (2) DISPLAY CIRCUIT

The luminescent display tube (DS1) is driven by the IC1 and IC2 drivers. These ICs contain such functions as input data latches, clock oscillators, timing counters, segment decoders, etc. The clock frequency is set by C2 and C6.

Displays for the RIT/ $\Delta$ TX shift frequency and memory channel are driven by IC2, and other displays are driven by IC1.

The signals for the display of "RTTY" through "GENE" are sent from the LOGIC unit to each segment. The segments are switched by the digit signals, T0 to T6 from IC1 and T3 from IC2, and lit dynamically. The letters "RIT", " $\Delta$ TX", "-" and "DUP" are connected to the same digit in the tube, thus the necessary word is selected by T4, T1 and T0 digit signals and dynamically lit.

## SECTION 12 MAINTENANCE AND ADJUSTMENT

### 12 - 1 CLEANING

After sitting in your ham shack for a period of time, the IC-751A will eventually require cleaning. Remove the knobs from the front panel and use a mild, soapy solution sparingly. Do not use strong chemicals or cleaning solvents. Wipe dry before replacing the knobs on the panel.

### 12 - 2 MAINTENANCE

**NOTE:** Before performing any work on the transceiver, make sure that the power cable is detached from the transceiver.

#### (1) PREPARATION

Remove the top and bottom covers by unscrewing the six screws from each cover and the three screws from each side of the transceiver.

#### (2) FUSE

Locate the cause for a blown fuse before replacing it and attempting to operate the IC-751A again.

Fuse Ratings:

- Inside IC-751A : 3A
- Supplied DC cable : 20A
  
- Optional IC-PS35  
POWER SUPPLY : 10A for 120V AC  
                          : 5A for 220 ~ 240V AC

#### (3) BACKUP BATTERY

The backup battery location is shown in SECTION 13 - 2.



The IC-751A uses an advanced, highly reliable RAM integrated circuit which is completely separate from the transceiver's main microprocessor. The purpose of the battery is to provide power to the RAM so it retains all memory information during power failures, or when the unit is unplugged or turned off.

The usual life of the lithium battery exceeds ten years. It is advisable to monitor the lithium battery carefully and replace it if there are repeated cases of display malfunction.

**NOTE:** Battery replacement must be done by an ICOM Authorized Dealer or ICOM Service Center.

#### (4) ORDERING PARTS

For the fastest service, supply all of the following information when ordering parts from your dealer:

- Equipment model and serial number
- Schematic part identifier (e.g. IC5, Q23)
- Printed circuit board number
- Part number and name
- Quantity required

### 12 - 3 ADJUSTMENTS

#### (1) BRAKE ADJUSTMENT

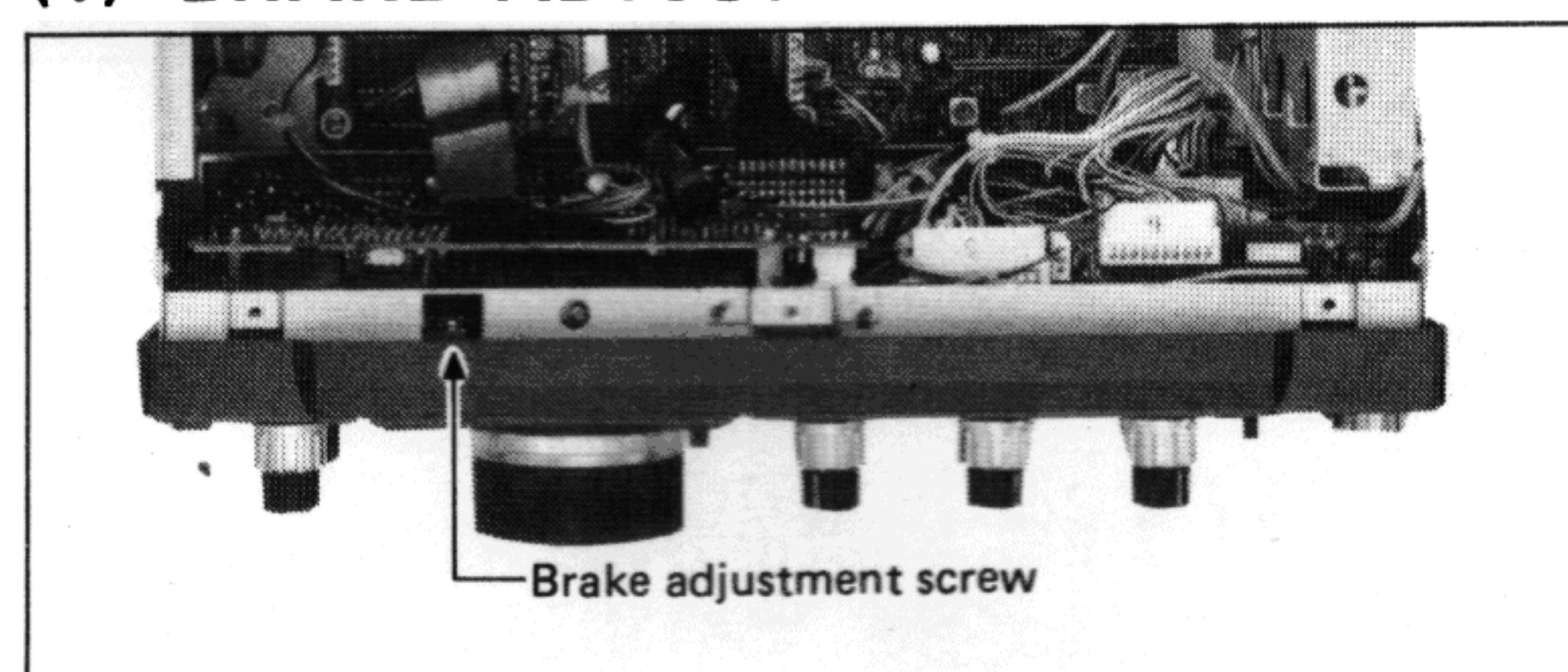

It is unnecessary to remove the bottom cover for the brake adjustment.

The TUNING CONTROL tension may be adjusted to the operator's preference. The screw adjustment is located on the bottom side of the transceiver cabinet below the TUNING CONTROL. The method for adjustment is as follows:

- 1) Rotate the TUNING CONTROL continuously and smoothly in one direction.
- 2) Adjust the brake adjustment screw either clockwise for tighter tension, or counterclockwise for looser tension as desired.

**(2) SIMPLE FREQUENCY ADJUSTMENT**

A very accurate frequency counter is required to align the frequency of the IC-751A. However, a simple check may be performed by receiving radio station WWV, WWVH or other standard frequency signals.

**NOTE:** This adjustment calibrates the reference oscillator, therefore it is unnecessary to calibrate on any other frequency.

- 1) Select the AM mode and GENERAL COVERAGE mode.
- 2) Use the TUNING CONTROL to set the frequency display to the exact frequency of the standard frequency station (10.000.0MHz for WWV/WWVH). Check for a strong receiver signal.
- 3) Turn ON the MARKER SWITCH on the top panel.
- 4) Adjust the MARKER CALIBRATOR on the top panel for zero beat. Zero beat exists when two signals are on exactly the same frequency resulting in no audible tone.
- 5) Turn OFF the MARKER SWITCH.

**(3) ELECTRONIC KEYS WEIGHT CONTROL**

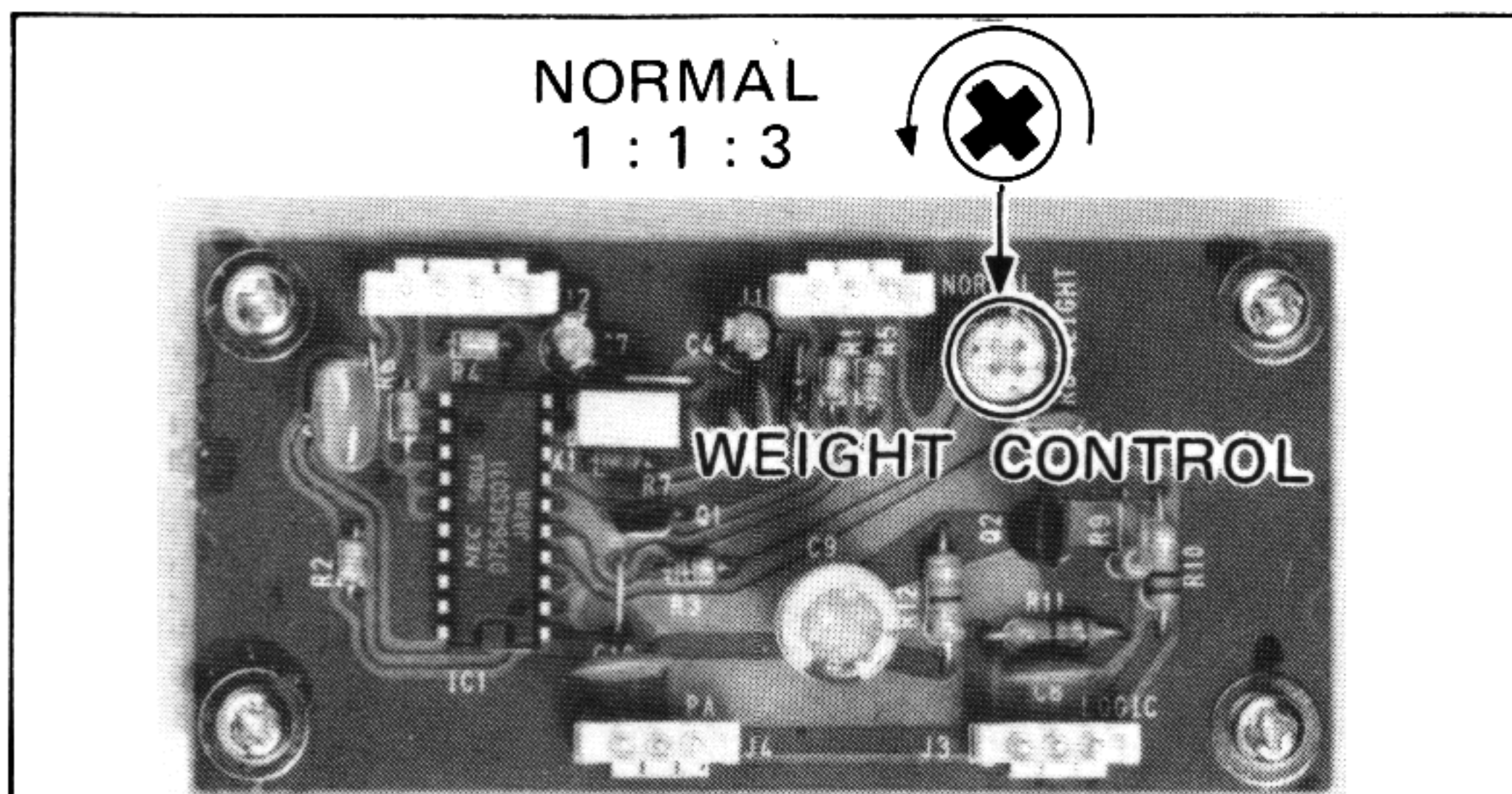

Features designed into the custom microprocessor include contact debouncing, RF immunity, self-completing character generation, dot memory and weight control.

The keying speed can be varied continuously from 5 to 45 words per minute.

The R8 WEIGHT CONTROL is set fully counterclockwise at the factory which sets the DOT:SPACE:DASH ratio at 1:1:3. DOTS and DASHES increase in length if R8 is turned clockwise.

**(4) CW SIDETONE FREQUENCY ADJUSTMENT**

- 1) This control is factory set for a 700Hz tone.
- 2) Connect a CW key to the KEY JACK on the rear panel and select the CW mode.
- 3) Close the CW key and adjust R374 for a suitable tone. Refer to SECTION 13 - 2 BOTTOM VIEW for the adjustment location.

**(5) SCAN SPEED ADJUSTMENT**

- 1) Activate the PROGRAMMED SCAN. Refer to SECTION 8 for information on the scanning functions.
- 2) Adjust R14 for a suitable scanning speed. Refer to SECTION 13 - 2 BOTTOM VIEW for the adjustment location.

**(6) BFO ADJUSTMENT**

- 1) Connect a frequency counter to CP1 on the MAIN unit. Refer to SECTION 13 - 1 TOP VIEW for the CP1 location.

MODE	FREQUENCY (MHz)		ADJUSTMENT
	RECEIVE	TRANSMIT	
USB	9.01300	9.01300	C202
LSB	9.01000	9.01000	L33
CW	9.00990	NO SIGNAL	L34
RTTY	9.008475	9.008475	L35
AM	NO SIGNAL	9.01000	L33
FM	NO SIGNAL	NO SIGNAL	-----

**(7) TRANSMIT AUDIO ADJUSTMENT**

The bass and treble response of your transmitted signal may be altered with the R155 adjustment on the MAIN unit. Refer to SECTION 13 - 1 TOP VIEW for the R155 location.

# SECTION 13 INSIDE VIEWS

## 13-1 TOP VIEW

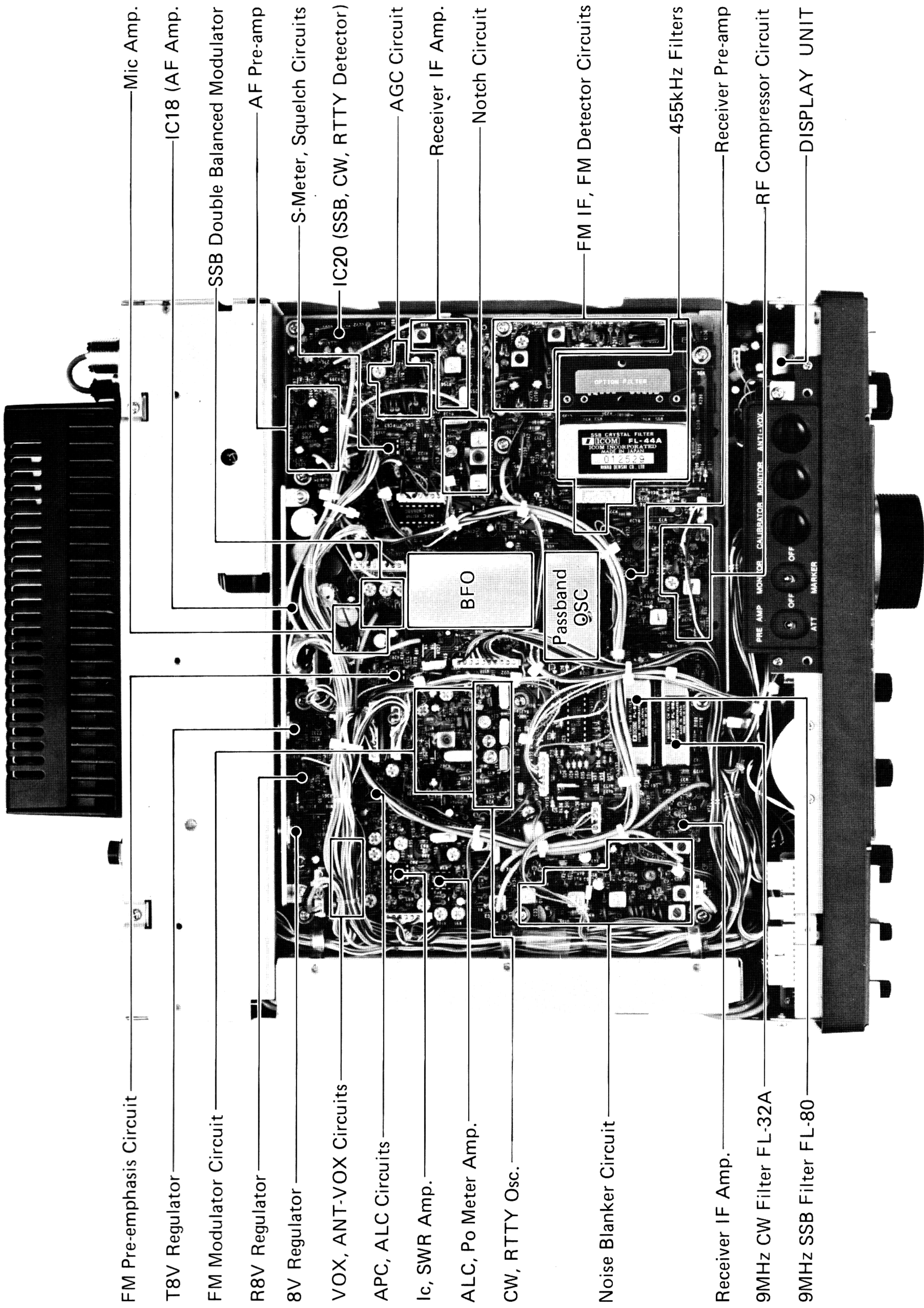

13 - 2 BOTTOM VIEW

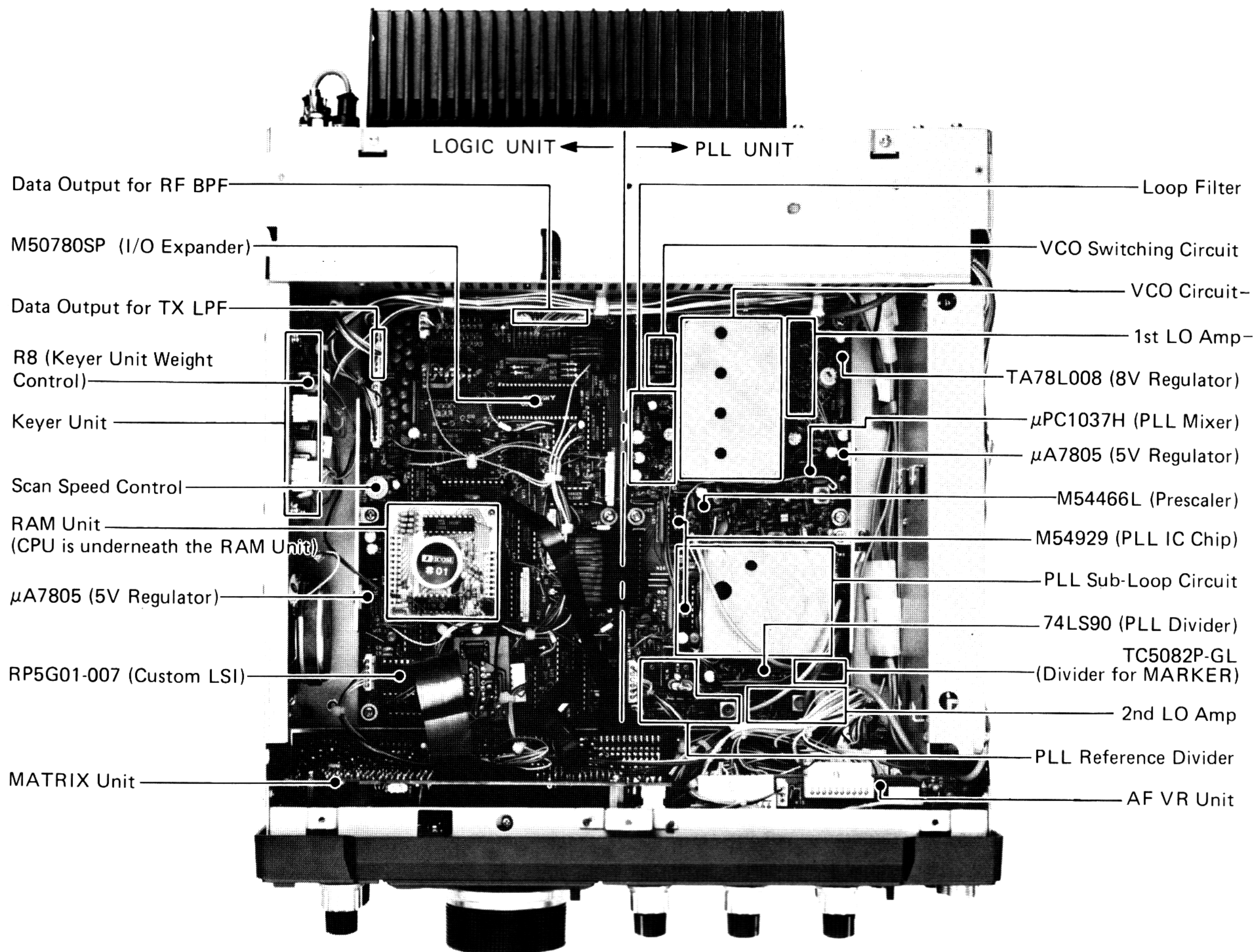

13 - 3 RF UNIT

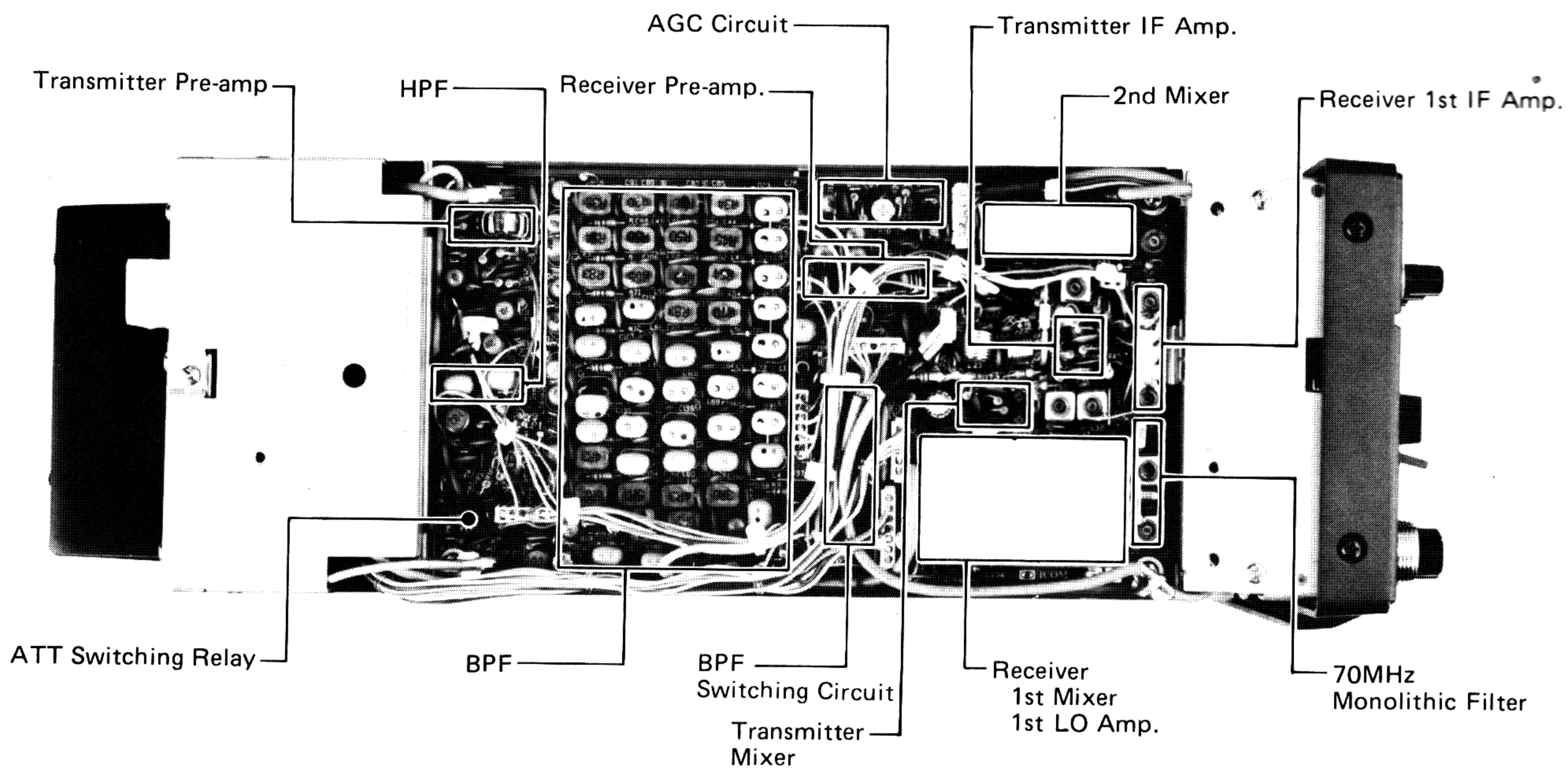



# 13 - 4 ADJUSTMENT LOCATIONS

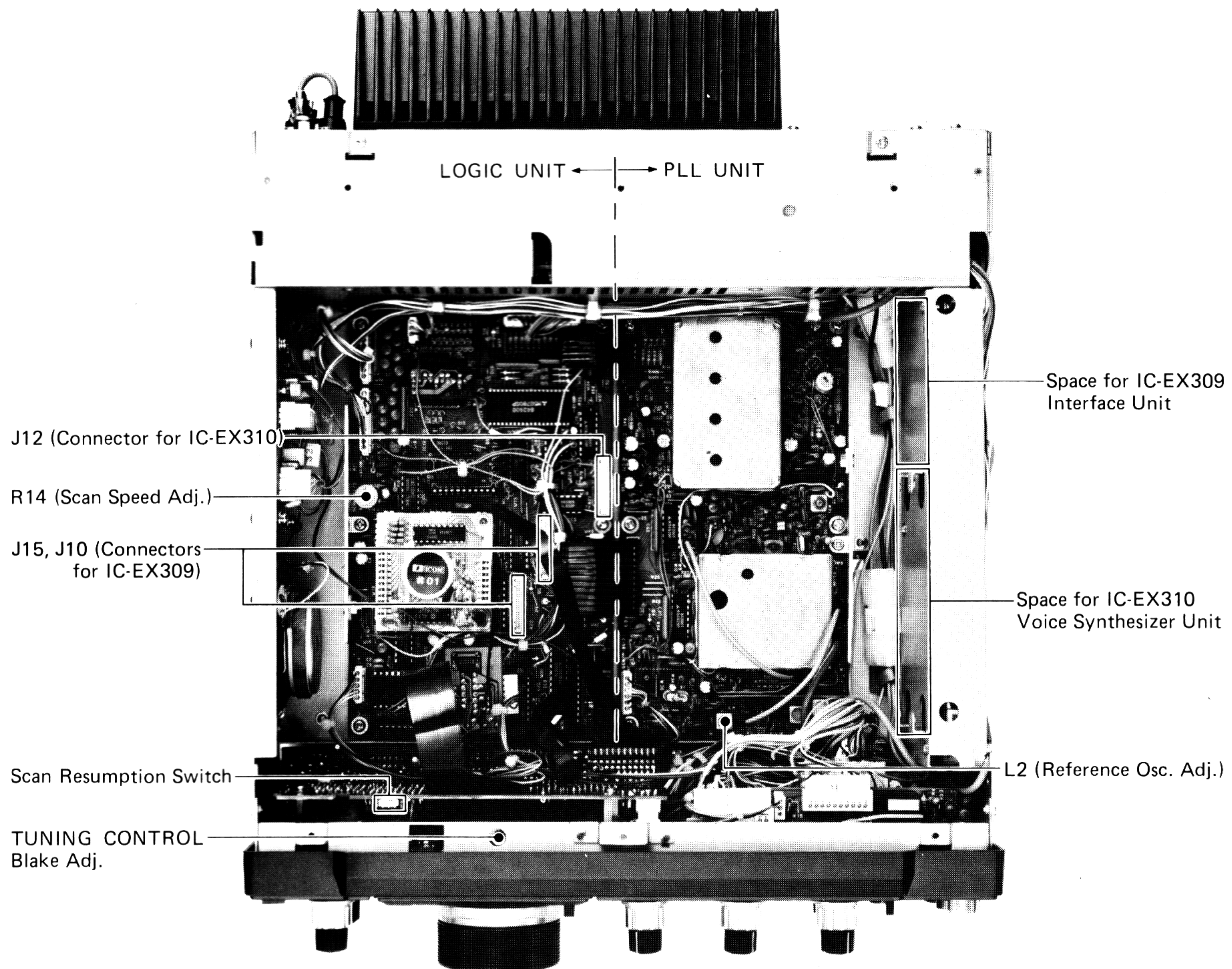
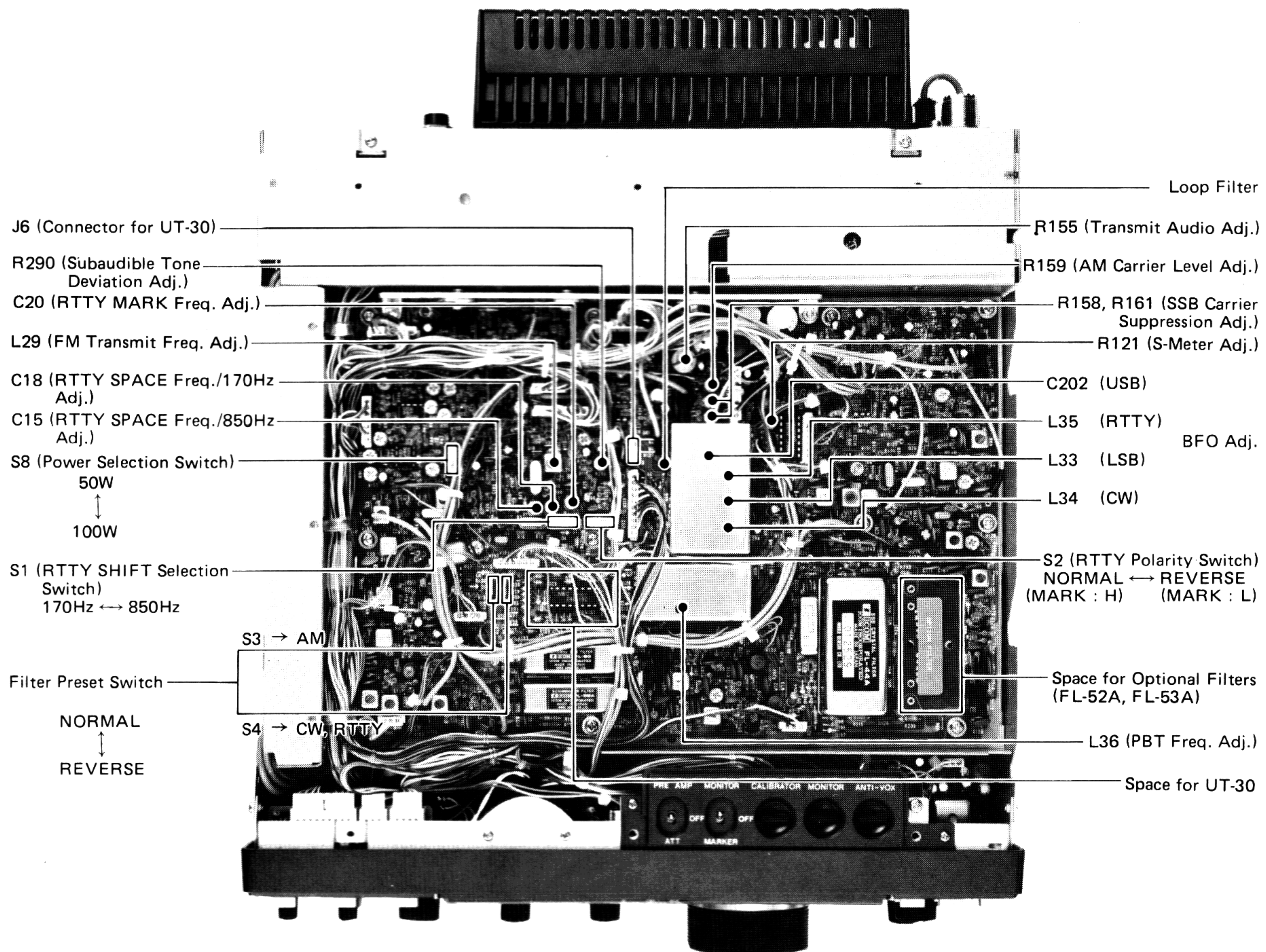

# SECTION 14 BLOCK DIAGRAM

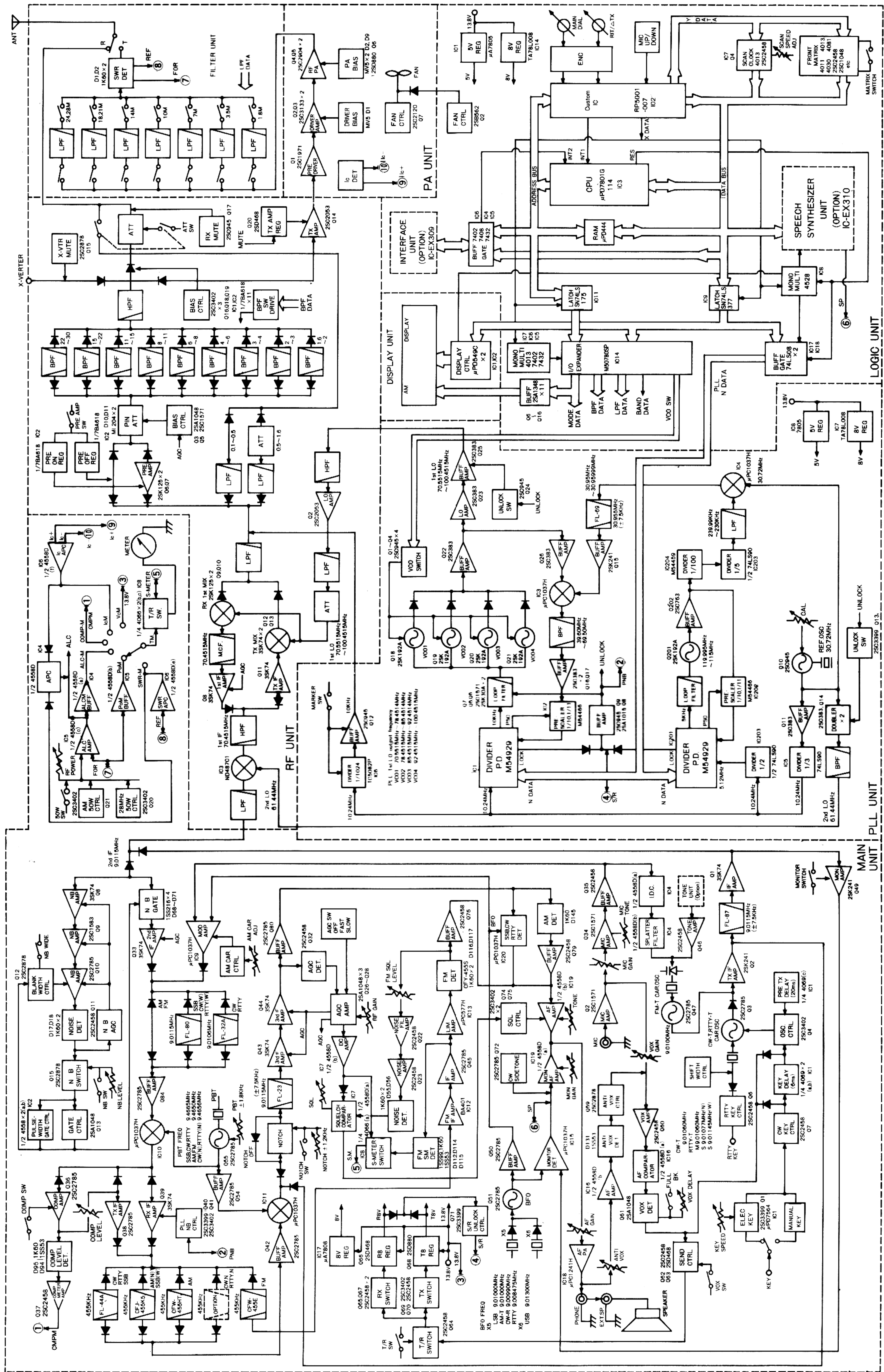

**SECTION 15 OPTIONS**

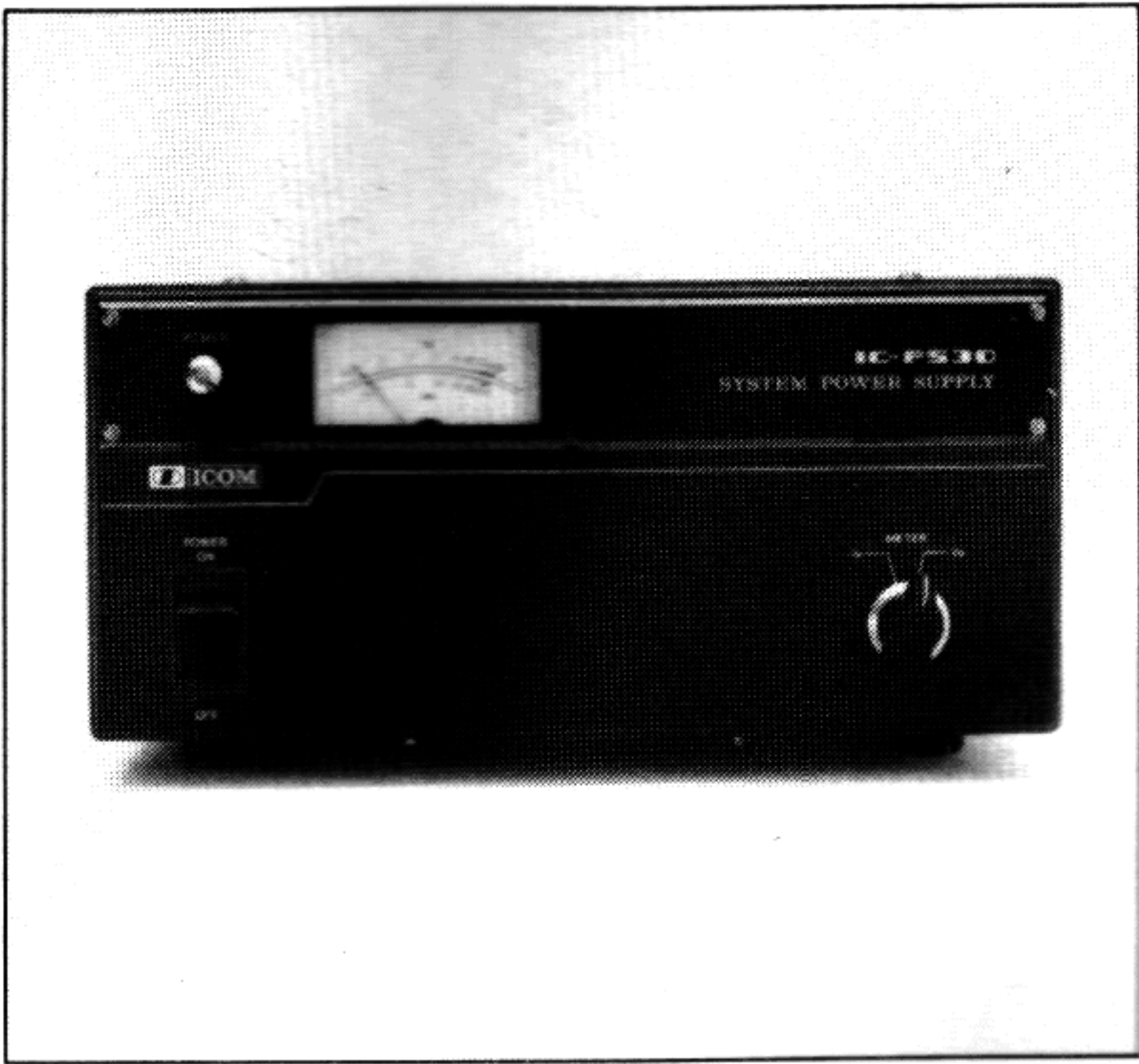

**IC-PS30  
AC POWER SUPPLY  
13.8V, 25A**

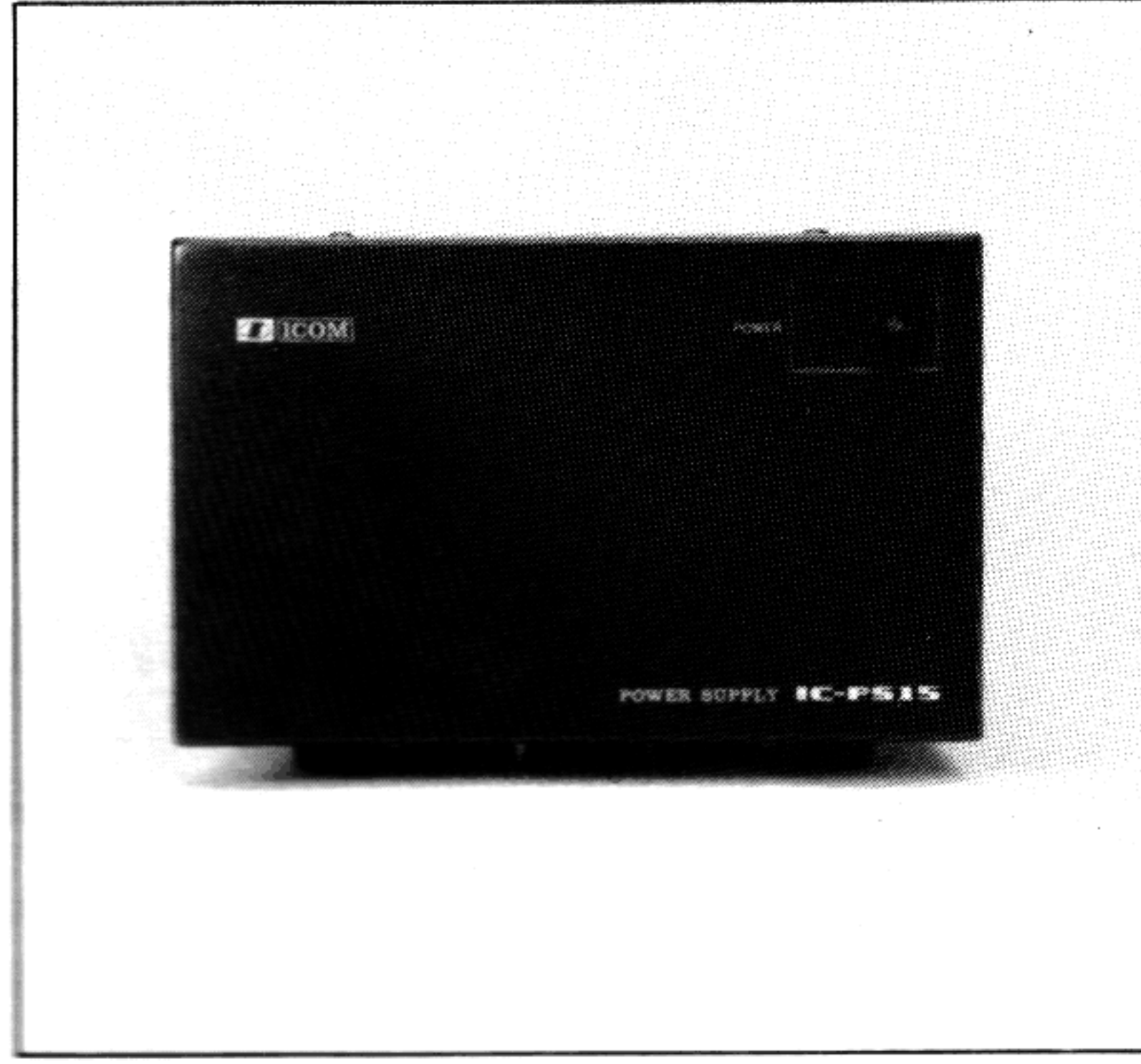

**IC-PS15  
AC POWER SUPPLY  
13.8V, 20A**

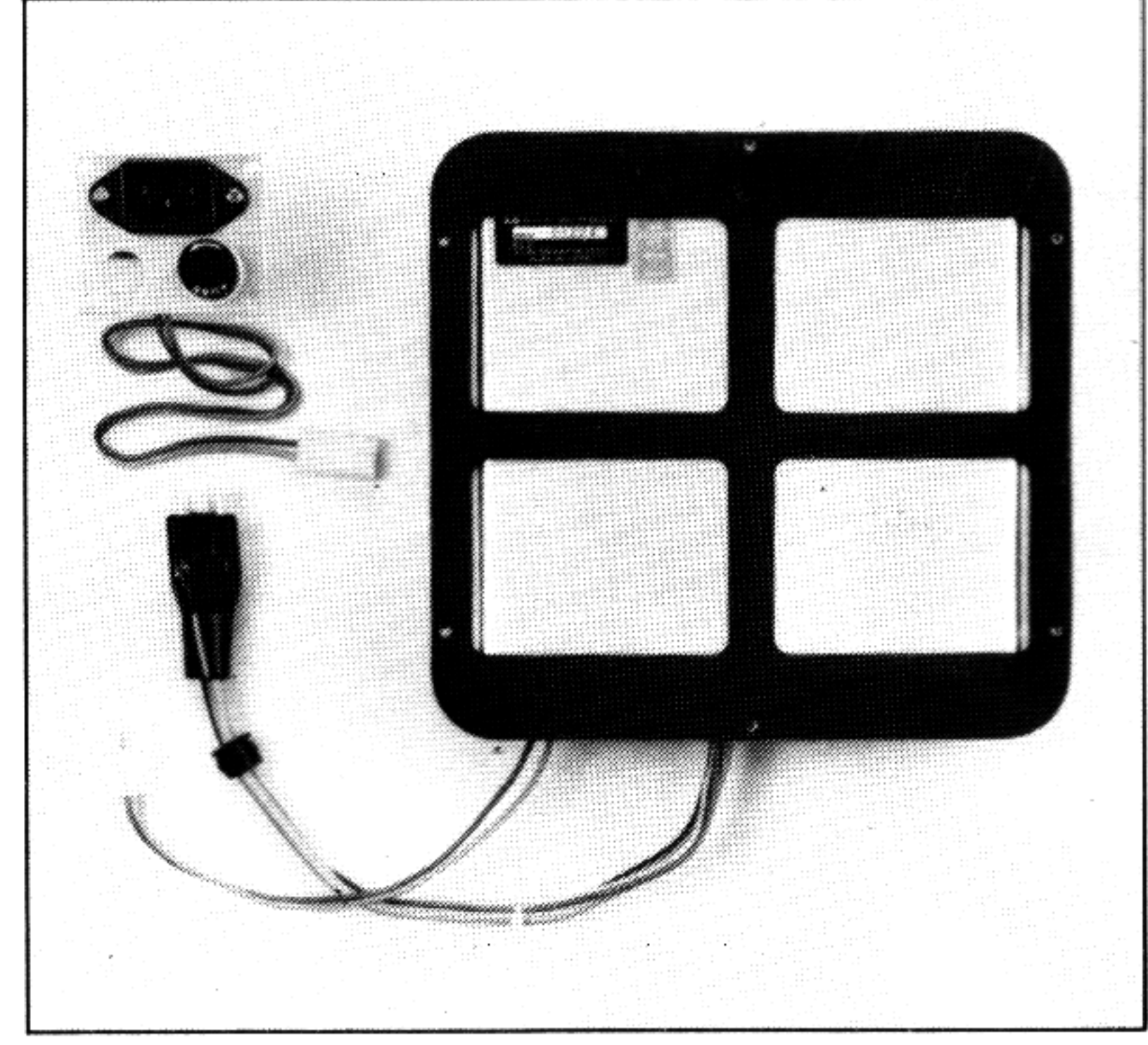

**IC-PS35  
INTERNAL  
POWER SUPPLY  
13.8V, 20A**



**IC-2KL  
500W LINEAR AMPLIFIER**



**IC-AT500  
500W AUTOMATIC  
ANTENNA TUNER**

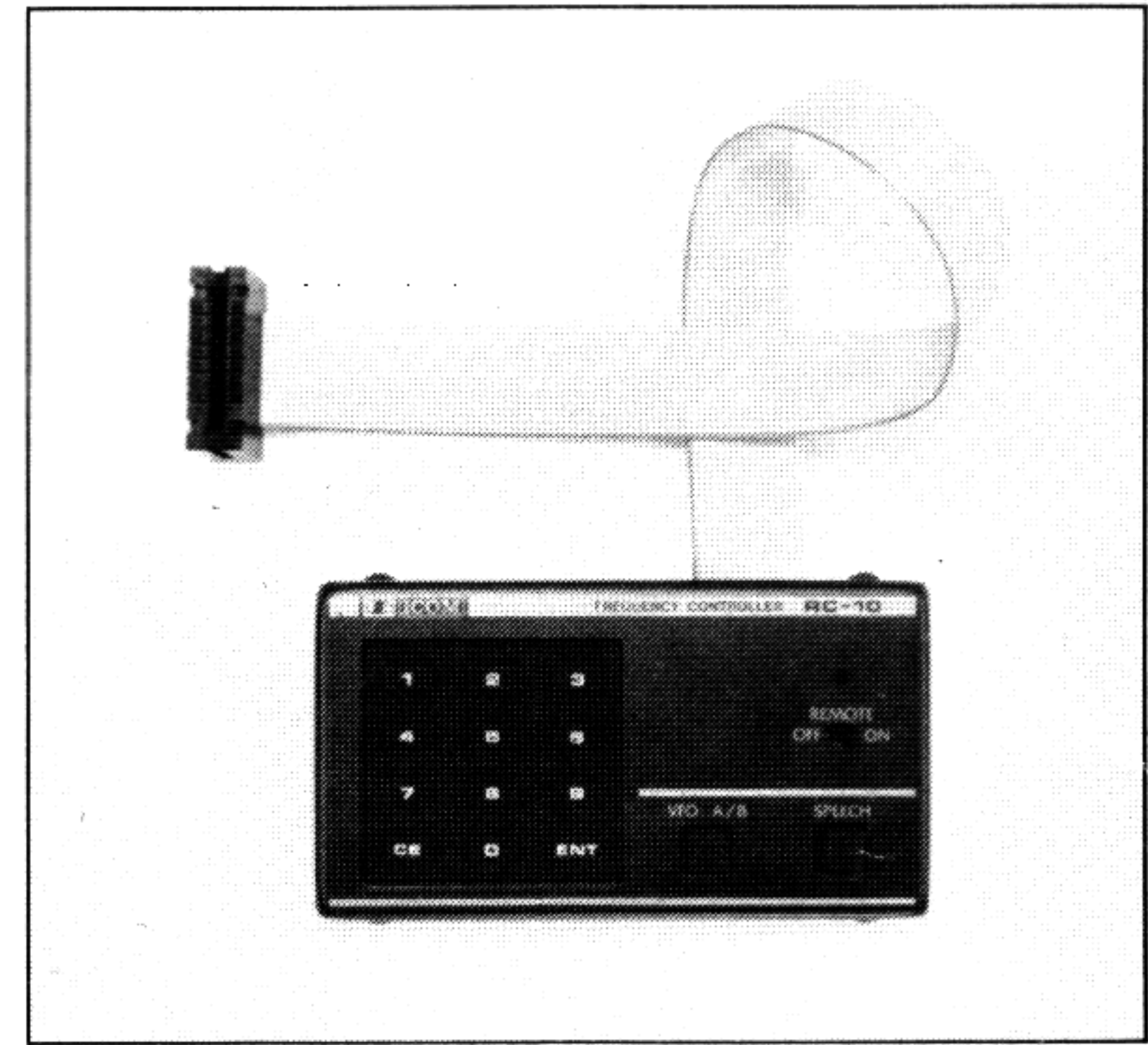

**RC-10  
FREQUENCY CONTROLLER**



**SM-10  
COMPRESSOR/GRAPHIC  
EQUALIZER DESK TOP  
MICROPHONE**



**SM-8  
DESK MICROPHONE**



**IC-SP3  
EXTERNAL SPEAKER**

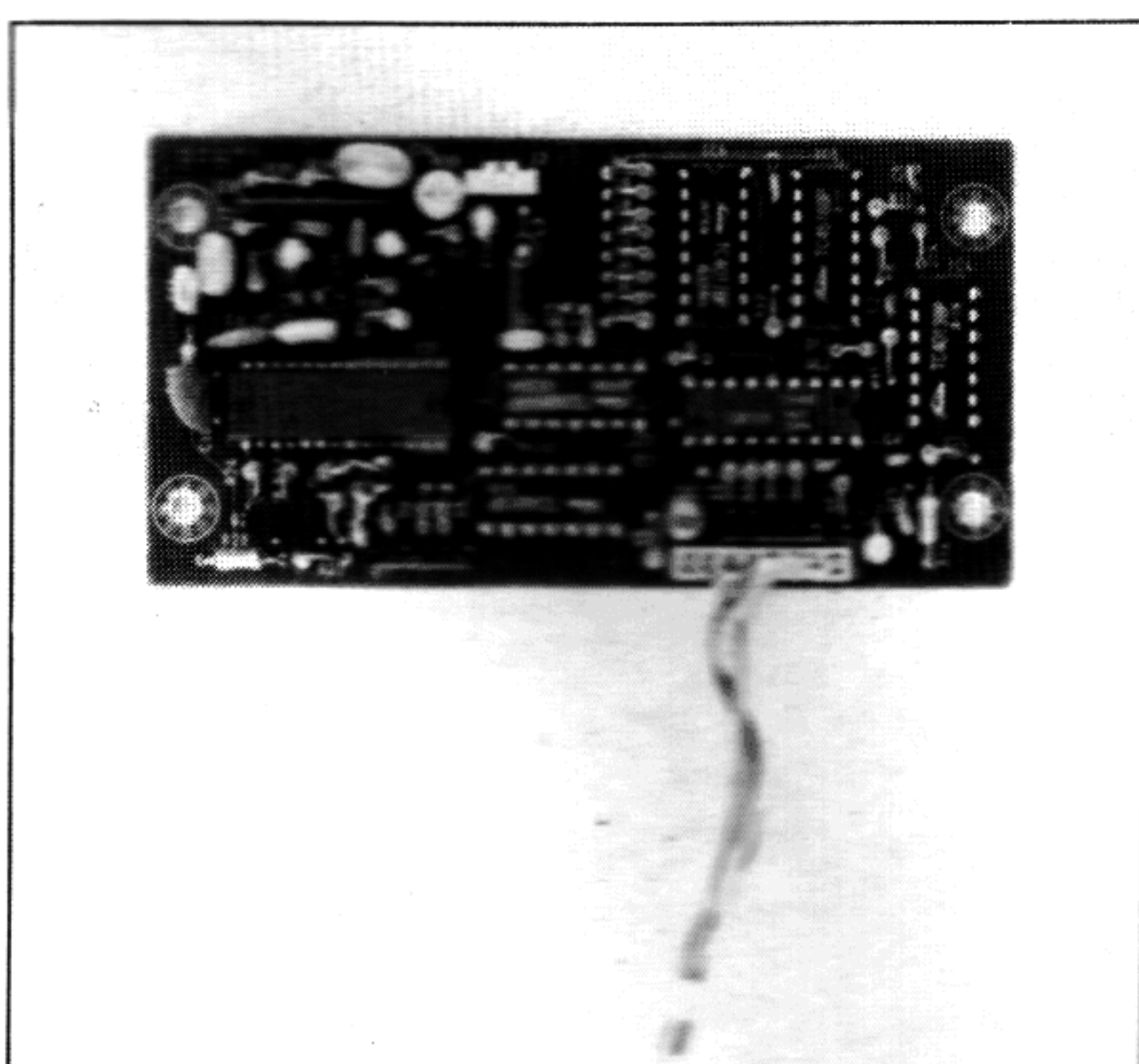

**IC-EX310  
VOICE SYNTHESIZER UNIT**

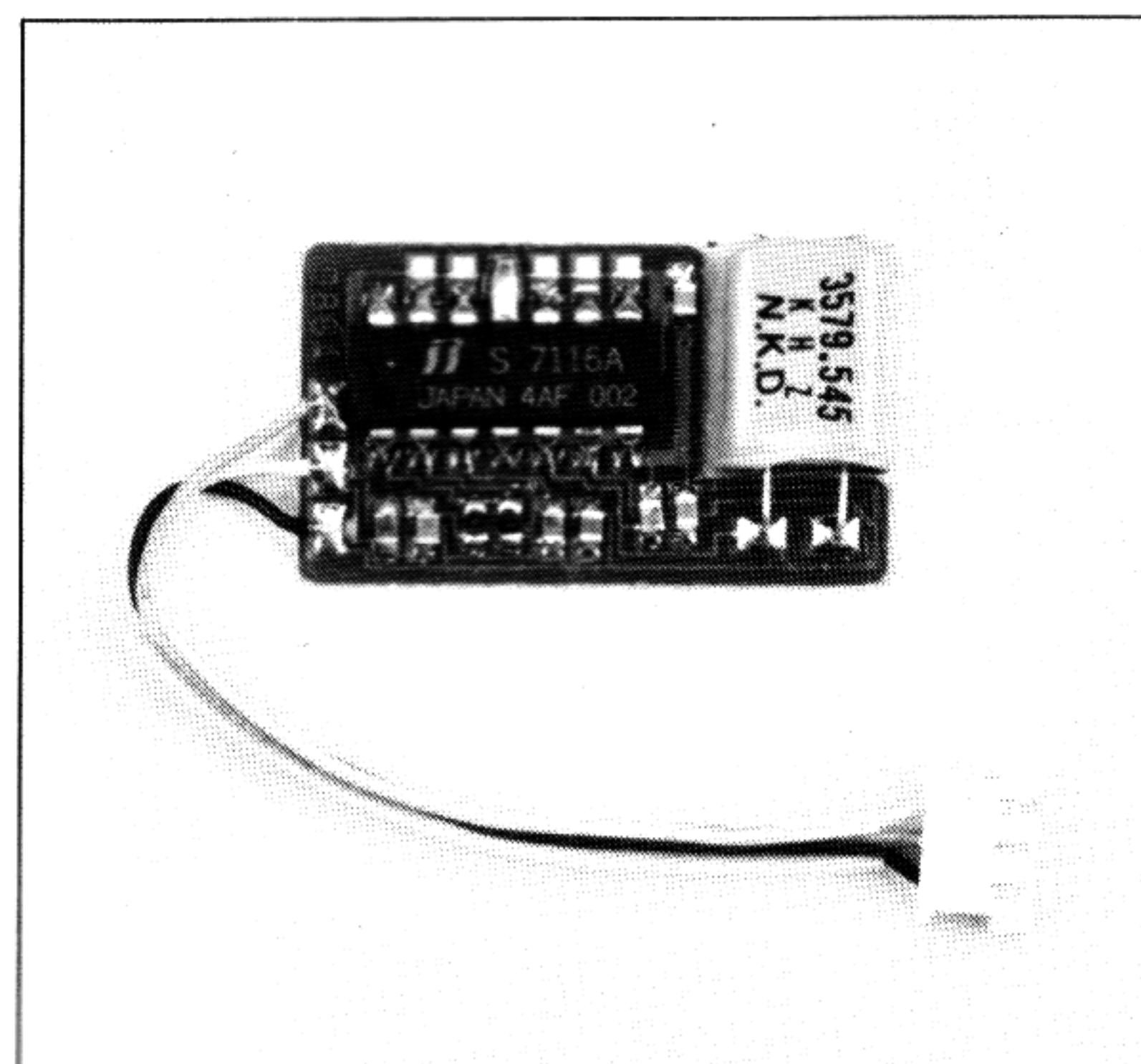

**UT-30  
PROGRAMMABLE TONE  
ENCODER UNIT**

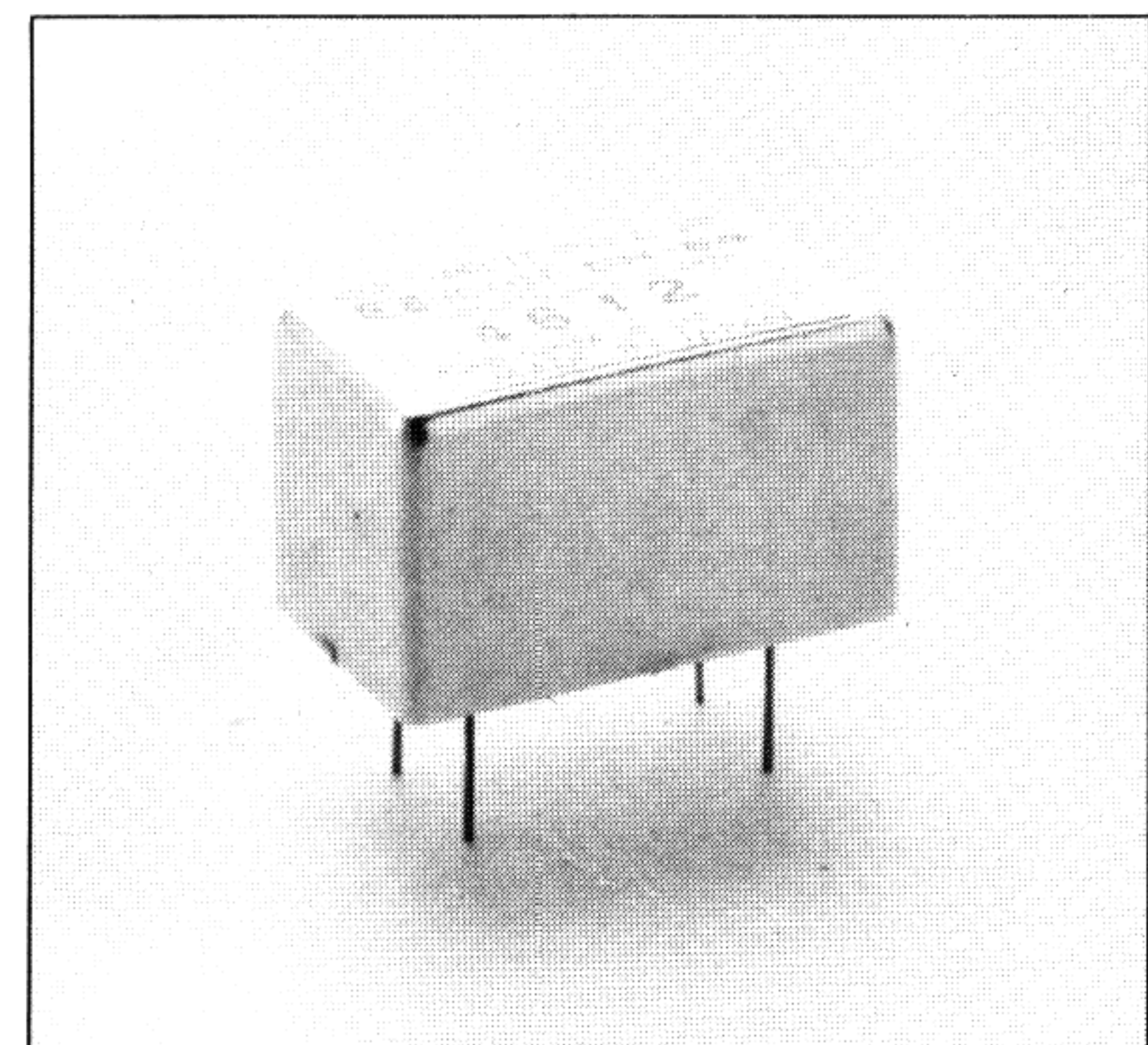

**CR-64  
HIGH-STABILITY  
CRYSTAL UNIT**