

IC-751

HF ALL BAND TRANSCEIVER
GENERAL COVERAGE RECEIVER

INSTRUCTION MANUAL

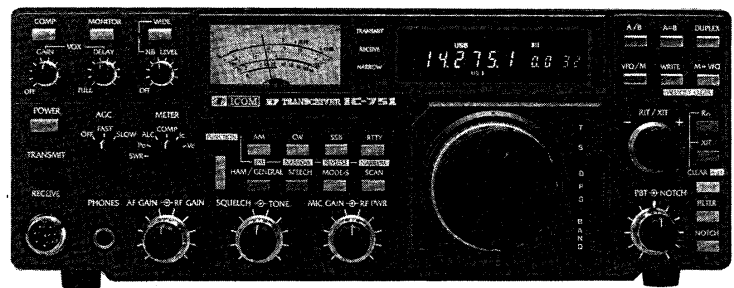

TABLE OF CONTENTS

| | | | |
|---------|------|--------------------------------------------------|----------|
| SECTION | 1 | SPECIFICATIONS | 1 |
| SECTION | 2 | FEATURES | 2 |
| SECTION | 3 | INSTALLATION | 3 |
| SECTION | 4 | OPERATING CONTROLS..... | 6 |
| | 4- 1 | FRONT PANEL..... | 6 |
| | 4- 2 | TOP COVER | 10 |
| | 4- 3 | REAR PANEL CONNECTIONS..... | 11 |
| SECTION | 5 | OPERATING INSTRUCTIONS..... | 12 |
| | 5- 1 | HOW TO TUNE | 12 |
| | 5- 2 | MEMORY CHANNEL OPERATION | 17 |
| | 5- 3 | TUNING BY UP/DOWN BUTTONS ON THE MICROPHONE..... | 19 |
| | 5- 4 | SCANNING OPERATION..... | 20 |
| | 5- 5 | SSB OPERATION | 21 |
| | 5- 6 | CW OPERATION..... | 23 |
| | 5- 7 | RTTY OPERATION | 24 |
| | 5- 8 | AM OPERATION..... | 25 |
| | 5- 9 | FM OPERATION..... | 25 |
| | 5-10 | GENERAL COVERAGE RECEIVER..... | 25 |
| | 5-11 | OTHER OPERATIONS..... | 26 |
| SECTION | 6 | OPTION INSTALLATION..... | 28 |
| SECTION | 7 | INSIDE VIEWS | 33 |
| SECTION | 8 | TROUBLESHOOTING..... | 35 |
| SECTION | 9 | BLOCK DIAGRAM..... | 36 |
| SECTION | 10 | SCHEMATIC DIAGRAM..... | SEPARATE |
| SECTION | 11 | BOARD LAYOUT..... | SEPARATE |

SECTION 1 SPECIFICATIONS

GENERAL

Number of Semiconductors:

| | |
|-------------------|-----|
| Transistors | 105 |
| FET | 16 |
| IC (Includes CPU) | 51 |
| Diodes | 219 |

Frequency Coverage:

| | |
|----------|--------------------|
| Ham Band | 1.8 MHz ~ 2.0MHz |
| | 3.45MHz ~ 4.1MHz |
| | 6.95MHz ~ 7.5MHz |
| | 9.95MHz ~ 10.5MHz |
| | 13.95MHz ~ 14.5MHz |
| | 17.95MHz ~ 18.5MHz |
| | 20.95MHz ~ 21.5MHz |
| | 24.45MHz ~ 25.1MHz |
| | 27.95MHz ~ 30.0MHz |

General Cover (Receive Only)

0.1MHz ~ 30.0MHz

Thirty 1MHz Segments (or Continuous)

RIT/XIT Coverage ±9.9KHz

Frequency Control:

CPU based 10Hz step Digital PLL synthesizer.

Independent Transmit-Receive Frequency Available on same band.

Frequency Readout:

6 digit 100Hz readout.

Frequency Stability:

Less than ±200Hz after switch on 1 min to 60 mins, and less than ±30Hz after 1 hour. Less than ±500Hz in the range of 0°C ~ +50°C.

Power Supply Requirements:

DC 13.8V ±15% Negative ground Current drain 20A max. (at 200W input)

AC power supply is available for AC operation.

Antenna Impedance:

50 ohms Unbalanced

Weight:

8.5Kg

Dimensions:

115mm(H) x 306mm(W) x 355mm(D)

TRANSMITTER

RF Power:

| | |
|----------------------------------------------|---------------------|
| SSB (A ₃ J) | 200 Watts PEP input |
| CW (A ₁), RTTY (F ₁) | 200 Watts input |
| FM (F ₃) | 200 Watts input |
| AM (A ₃) | 40 Watts output |

Continuously Adjustable Output power 10 Watts ~ Max.

Emission Mode:

| | |
|------------------|-----------------------------------------|
| A ₃ J | SSB (Upper sideband and Lower sideband) |
| A ₁ | CW |
| F ₁ | RTTY (Frequency Shift Keying) |
| A ₃ | AM |
| F ₃ | FM |

Harmonic Output:

More than 40dB below peak power output

Spurious Output:

More than 60dB below peak power output

Carrier Suppression:

More than 40dB below peak power output

Unwanted Sideband:

More than 55dB down at 1000Hz AF input

Microphone:

Impedance 600 ohms

Input Level 12 millivolts typical

Dynamic or Electret Condenser Microphone
(Optional desk mic IC-SM6 can be used.)

RECEIVER

Receiving System:

SSB, CW, RTTY, AM

Quadruple Conversion Superheterodyne with continuous Bandwidth Control.

FM Triple Conversion Superheterodyne

Receiving Mode:

A₁, A₃J (USB, LSB) F₁ (Output FSK audio signal), A₃, F₃

Intermediate Frequencies:

| | |
|-----|-------------------------------------------------------------|
| 1st | 70.4515MHz |
| 2nd | 9.0115MHz (SSB), 9.0106MHz (CW, RTTY) 9.0100MHz (AM, FM) |
| 3rd | 455KHz |
| 4th | 350KHz (except FM) |

with continuous Bandwidth Control

Sensitivity:

SSB, CW, RTTY

0.1 ~ 0.5MHz Less than 0.5μV for 10dB S/N

0.5 ~ 1.6MHz Less than 1.0μV for 10dB S/N

1.6 ~ 30MHz Less than 0.15μV for 10dB S/N

AM 0.1 ~ 0.5MHz Less than 3μV for 10dB S/N

0.5 ~ 1.6MHz Less than 6μV for 10dB S/N

1.6 ~ 30MHz Less than 1μV for 10dB S/N

FM 1.6 ~ 30MHz Less than 3μV for 12dB SINAD.

Squelch Sensitivity:

1.6 ~ 30MHz Less than 0.3μV

Selectivity:

SSB, CW, RTTY

2.3KHz (Adjustable to 0.8KHz Min)
at -6dB

4.0KHz at -60dB

AM 2.4KHz at -6dB, 4.2KHz at -60dB
(When Filter switch ON)

4.0KHz at -6dB, 15KHz at -50dB

FM 15KHz at -6dB, 30KHz at -60dB

Notch Filter Attenuation:

More than 45dB

Spurious Response Rejection Ratio:

More than 60dB

Audio Output:

More than 3 Watts

Audio Output Impedance:

8 ohms

Specifications are approximate and are subject to change without notice or obligation.

SECTION 2 FEATURES

ALL BAND, ALL MODE, ALL SOLID-STATE

The IC-751 covers all the Amateur HF frequencies from 1.8MHz to 29.7MHz, including the new three bands of 10MHz, 18MHz and 24MHz. It offers not only SSB, but also CW, AM, FM and RTTY. All of the circuits in the IC-751, including the driver and final power stages are completely solid-state, and provide about 100 watts output.

GENERAL COVERAGE RECEIVER CAPABILITY

The IC-751 has capabilities for an all amateur band transceiver as well as a general coverage receiver between 100KHz and 30MHz with continuous tuning. The Up-conversion system using a high side IF and Microcomputer Control System make these capabilities possible.

In addition to these, the low-pass filters and the band-pass filters are selected by an electric signal from the CPU and it makes a no tune-up system.

DUAL VFO

Dual VFO's controlled by a large tuning knob provide easy access to split frequencies used in DX operation. Normal tuning rate is in 10Hz increments and increasing the speed of rotation of the main tuning knob shifts the tuning to 100Hz increments automatically. Pushing the tuning speed button gives 1KHz tuning. Digital outputs are available for computer control of the transceiver frequency and functions, and for a synthesized voice frequency readout.

32 MEMORIES

Thirty two tunable memories are provided to store mode, HAM/GENERAL COVERAGE mode, and frequency, and the RAM is backed up by an internal lithium memory backup battery to maintain the memories for up to seven years. Scanning of frequencies, memories and bands are possible from the unit, or from the IC-HM12 scanning microphone. In the Mode-S mode, only those memories with a particular mode are scanned; others are bypassed. Data may be transferred between VFO's, from VFO to memories, or from memories to VFO.

OUTSTANDING RECEIVER PERFORMANCE

Utilizing an ICOM developed J-FET DBM, the IC-751 has a 105dB dynamic range. The 70.4515MHz first IF virtually eliminates spurious responses, and a high gain 9.0115MHz second IF, with ICOM's PBT selectivity. A deep IF notch filter, adjustable AGC and noise blanker (can be adjusted to eliminate the woodpecker), audio tone control, plus RIT with separate readout provides easy-to-adjust, clear reception even in the presence of strong QRM or high noise levels. A low noise receiver preamp provides exceptional reception sensitivity as required.

TRANSMITTER

The transmitter features high reliability transistors in a low IMD (-38dB @ 100W), full 100% duty cycle (internal cooling fan standard), 12 volt DC design. Quiet relay selection of transmitter LPF's, transmit audio tone control, monitor circuit (to monitor your own CW or SSB signal), XIT, and a high performance speech processor enhance the IC-751 transmitter's operation. For the CW operator, semi break-in or full QSK is provided for smooth, fast break-in keying.

OTHER FEATURES

All of the above features plus full function metering, SSB and FM squelch, convenient large controls, a large selection of plug-in filters, and a new high visibility multi-color fluorescent display that shows frequency in white, and other functions in white or red, make the IC-751 your best choice for a superior grade HF base transceiver.

SECTION 3 INSTALLATION

BE SURE TO READ THE FOLLOWING INSTRUCTIONS CAREFULLY BEFORE OPERATION

3 - 1 UNPACKING

Carefully remove your transceiver from the packing carton and examine it for signs of shipping damage. Should any be apparent, notify the delivering carrier or dealer immediately, stating the full extent of the damage. It is recommended you keep the shipping cartons. In the event storage, moving, or reshipment becomes necessary they will be handy. Accessory cables, plugs, etc., are packed with the transceiver. Make sure you have not overlooked anything.

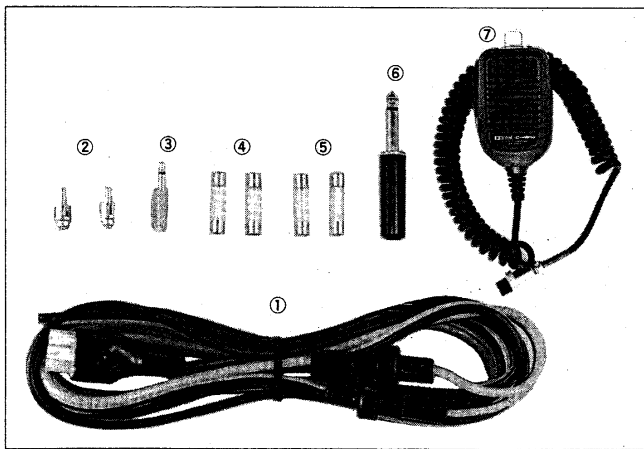

| | |
|------------------------------------|---|
| 1. DC Power Cord | 1 |
| 2. Pin Plugs | 2 |
| 3. External Speaker Plug | 1 |
| 4. Spare Fuses (20 Amp) | 2 |
| 5. Spare Fuses (3 Amp) | 2 |
| 6. Key Plug | 1 |
| 7. Microphone (IC-HM12) | 1 |

3 - 2 RECOMMENDATIONS FOR INSTALLATION

1. Avoid placing the IC-751 in direct sunlight, high temperature, dusty or humid places.
2. The temperature of the set will usually become relatively warm during transmission. Any equipment should be at least 1 inch (3cm) away from the unit so as to provide good ventilation. Be sure that nothing is on and just behind the rear PA heatsink to ensure good ventilation. Also avoid places near outlets of heaters, air conditioners etc.
3. Place the unit so that the controls and switches can easily be handled and the frequency indication and meter can easily be read.
4. For mobile installation, an optional mounting bracket is available. Select the best location that can stand the weight of the unit and that does not interfere with your driving in any way.
5. Use the Ground Lug!

3 - 3 POWER SUPPLY

For AC operation, use the special power supply IC-PS15, or optional built-in power supply IC-PS35. If you would

like to use your car battery or any other DC power supply, be sure that its output voltage is 12-15 Volts and the current capacity is at least 20 Amps. The maximum power consumption of the set during transmission runs from 16-20 Amps, so keep that in mind if the unit is installed in your automobile, and turn it on after you have started the engine. Attention should also be paid to the condition of the battery and electrical system.

The connection of the DC power cord supplied with the IC-751 is done in the following way: First make sure that the power switch of the unit is in the OFF position and the T/R switch is in the receive position. Connect the cord to the DC power supply with the RED lead to the positive terminal and the BLACK lead to the negative terminal. (Reverse connection will cause the protection circuit to operate and blow the fuse.) Connect the DC plug to the socket on the rear panel of the IC-751. Refer to the drawing below.

For AC operation (with IC-PS15)

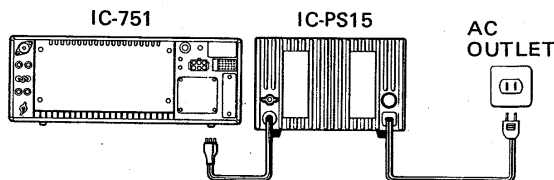

For AC operation (when optional IC-PS35 is installed).

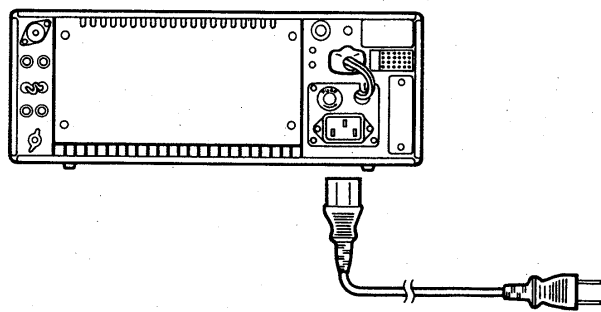

For DC operation

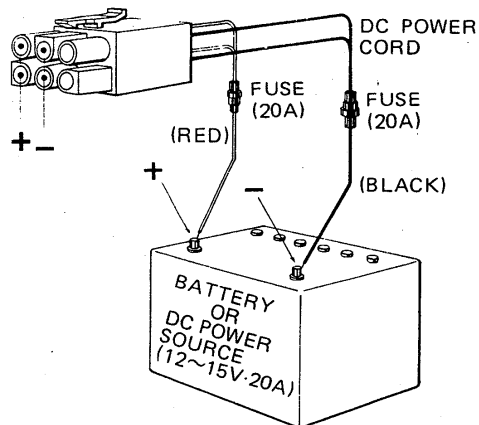

3 - 4 ANTENNA

Antennas play a very important role in radio communication. If the antenna is inferior, your transceiver cannot give you the best performance. With a good antenna and feeder cable having 50 ohms impedance, you should easily get the desired matching and performance. Carefully install a high performance antenna that suits the frequency band(s) you wish to operate on and place it as high as possible. Be especially careful of the condition of the connectors as loose connections will deteriorate the performance. Be sure to connect the ground terminal of a whip antenna, if used, to the body of your car.

As the output is quite high, avoid connecting the antenna connector to open lines and do not transmit under mismatched conditions. Otherwise the final stage could be overloaded and cause a malfunction of the unit.

Since the IC-751 has a General Coverage receiver it is recommended that a long-wire general coverage antenna and an antenna coupler be used. The antenna's impedance should be 50 ohms. To attempt to use the Ham band antenna for general coverage reception could result in mismatching, and attendant poor reception, however it will be good enough for strong Broad Casting stations.

3 - 5 GROUND

In order to prevent electrical shocks, TVI, BCI and other problems, be sure to connect a heavy wire ground, as short as possible, from a good earth point to the ground terminal on the rear panel.

3 - 6 MICROPHONE

The supplied electret condenser type hand microphone IC-HM12 or optional desk mic IC-SM6 can be used. Merely plug it into the proper receptacle on the front panel. Should you wish to use a different microphone, make certain it has proper output level. Particular care should be exercised in wiring also, as the internal electrical switching system is dependent upon it. Refer the schematics for the proper hookup.

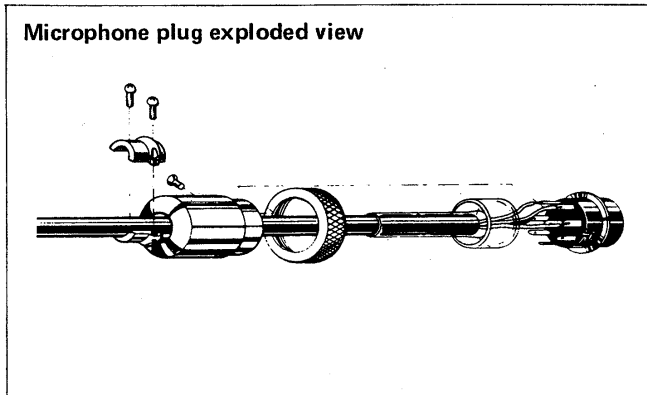
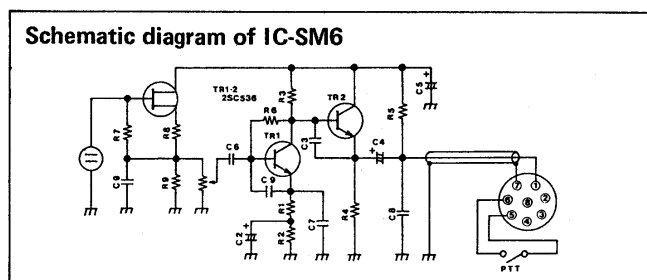
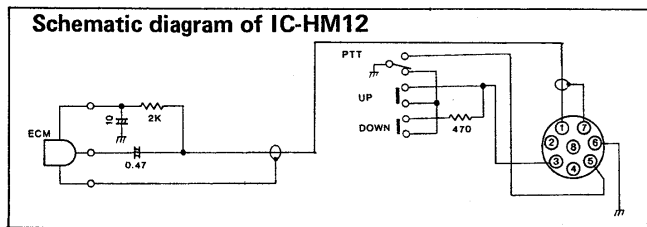

3 - 8 CW KEY

When operating CW, connect a key to the KEY jack on the rear panel with the key plug supplied (1/4 inches standard plug). The connection of the plug is shown below.

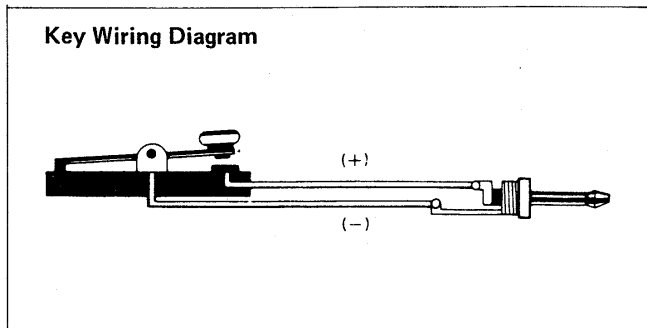

If the terminals have polarity, be sure to make the correct connection. Note that the keyed voltage when switching with semiconductors or relays with resistors in the circuit, should be adjusted to be below 0.4 Volts!

3 - 8 RTTY

When operating RTTY, connect the ACC socket pins 8 (ground) and 9 to your tele-typewriter through a high speed relay or a level converter to TTL level, and the tones for your terminal unit will be available from pin 4. The AF output level is about 300mVp-p for S-9 signal. For details, refer to 5 - 7 RTTY OPERATION on page 24.

3 - 9 EXTERNAL SPEAKER

The IC-751 contains an internal speaker, and is also designed so that it can drive an external speaker from the external (EXT) speaker jack on the rear panel. Be sure the impedance of the external speaker is 8 ohms, and remember that with the external speaker connected, the internal speaker is disabled.

3 - 10 HEADPHONES

Any good headphone set, including stereo type, that have 4-16 ohms impedance can be used. With the plug inserted halfway into the PHONES jack, both the headphone and speaker will operate. This is convenient when others wish to listen in on the station, or you wish to record contacts

using a tape recorder connected to the headphone jack. With a stereo headphone set inserted this way, however, the headphone will lose the sound on one side. With the plug inserted completely, only the headphone works.

3 - 11 COOLING FAN

The rear of the PA unit is designed to provide for adequate cooling, but with 200 Watts input the final stage produces quite a bit of heat, and its temperature may rise during prolonged transmissions. The fan is connected to a temperature monitoring circuit which monitors the temperature of the final stage. The fan operates as follows:

1. The fan does not operate both in the receive and transmit modes.
2. When the temperature rises to a point (50°C) detected by the monitor circuit the fan will operate during both transmit and receive to provide additional cooling.
3. If the temperature rises to a danger limit (90°C) the fan will run much more rapidly. Investigate the cause of overheating i.e. antenna mismatch, etc. and correct the cause of the overheating before starting to transmit again.

3 - 12 ACCESSORY (ACC) SOCKET

Various functions are available through the accessory socket such as modulation output, receiver output, T/R change-over, and so forth. The table below shows those terminals.

ACC SOCKET CONNECTIONS

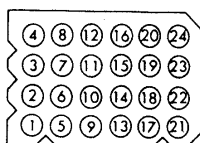

Outside view

| PIN No. | FUNCTION |
|---------|----------------------------------------------------------------------------------------------------|
| 11. | Input for TRANSVERTER control. When 8 Volts DC is applied, the set can operate with a transverter. |
| 12. | Output reference voltage for band switching. |
| 13. | Output for external band switching. |
| 14.~24. | NC |

3 - 13 CAUTIONS

As the unit has already been closely adjusted with highly sophisticated measuring instruments, never tamper with the turnable resistors, coils, trimmers, etc.

C-MOS is used in the Logic unit as well as the PLL. C-MOS ICs are very susceptible to excessive static charges and over current and care must be used when handling them. Therefore, avoid touching the Logic unit and the nearby circuitry unless absolutely necessary. When it is necessary to check the circuitry, observe the following points.

Ground all measuring instruments, the soldering iron, and other tools. Do not connect or disconnect the C-MOS IC from its socket, or solder it when the power is on. Do not apply voltage of less than -0.5 or more than +5 Volts to the input terminals of the IC. DO NOT MEASURE WITH AN OHMMETER.

| PIN No. | FUNCTION |
|---------|-----------------------------------------------------------------------------------------------------------|
| 1. | Output from the squelch control stage. (+8V when the squelch is ON) |
| 2. | 13.8 Volts DC in conjunction with the power switch operation. |
| 3. | Connected to Push-to-talk, T/R change-over switch. When grounded, the set operates in the transmit mode. |
| 4. | Output from the receive detector stage. Fixed output regardless of AF output or AF gain. |
| 5. | Output from Transmitter MIC amplifier stage. (Input for MIC gain control stage.) |
| 6. | 8 Volts DC available when transmitting. (relay can not be directly actuated. Max. 5mA). |
| 7. | Input for external ALC voltage. |
| 8. | Ground |
| 9. | Input for RTTY keying (MARK: HIGH level, SPACE: LOW level: This can be reversed by the internal switch.). |
| 10. | NC (No Connection) |

SECTION 4 OPERATING CONTROLS

4-1 FRONT PANEL

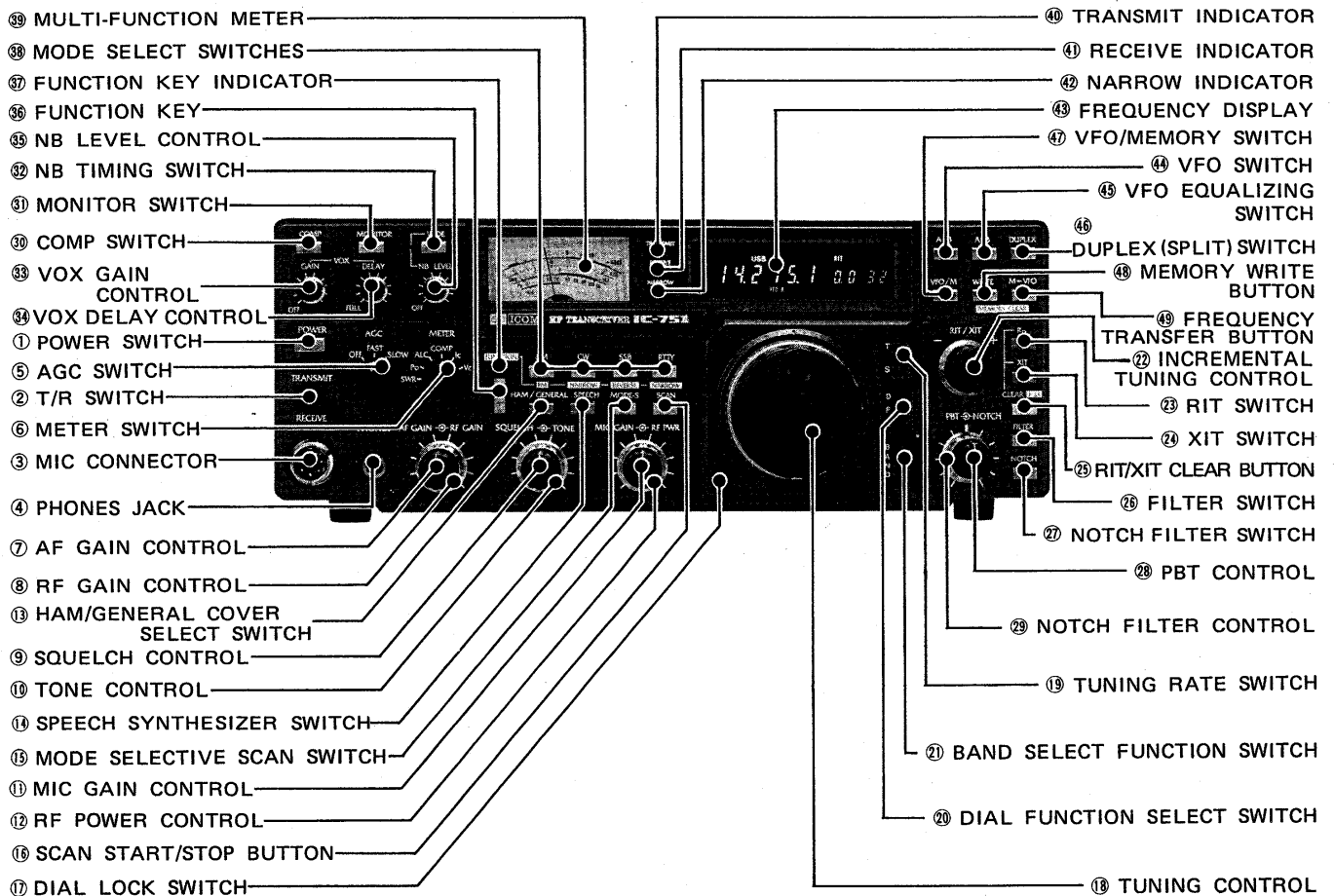

1. POWER SWITCH

The POWER SWITCH is a push-lock type switch which controls the input DC power to the IC-751. When the external AC power supply (IC-PS15) or optional built-in AC power supply (IC-PS35) is used, the switch also acts as the AC power supply switch. When the switch is pushed in and locked, power is supplied to the set. When the switch is pushed again and released, power is cut to all circuits (except the PA unit when using an external DC power supply).

2. T/R (TRANSMIT/RECEIVE) SWITCH

This switch is for manually switching from transmit to receive and vice versa. Set the switch to RECEIVE (down) and the IC-751 is in the receive mode. Set the switch to TRANSMIT (up) and it switches to transmit. When switching with the PTT switch on the microphone or with the VOX switch set to ON, the T/R switch must be in the RECEIVE position.

3. MIC CONNECTOR

Connect a suitable microphone to this jack. The supplied hand microphone IC-HM12 or optional desk mic IC-SM6

can be used. If you wish to use a different microphone, refer to the drawings on page 4.

4. PHONES JACK

Accepts a standard 1/4 inch headphone plug for headphones of 4 ~ 16 ohms. Stereo phones can be used without modification.

5. AGC (AUTOMATIC GAIN CONTROL) SWITCH

For changing the time-constant of the AGC circuit. With the switch in the SLOW position the AGC voltage is released slowly, and thus is suitable for SSB reception. With the switch in the FAST position, the AGC voltage is released faster, and the AGC is suitable for stations suffering from fast fading or when operating in the CW mode.

When the control is in the OFF position, the AGC function is turned OFF and the S-meter does not swing even if a signal has being received. (The AGC does not actuate in the FM mode.)

6. METER SWITCH

In the transmit mode, the meter has six functions.

1. Vc Indicates the collector voltage of the final transistors.
2. Ic Indicates the collector current of the final transistors.
3. COMP Indicates the compression level when the speech processor is in use.
4. ALC Indicates the ALC level. The meter begins to function when the RF output power reaches a certain level.
5. Po Indicates an approximate RF output power.
6. SWR SWR can be measured by setting this switch to the Po position and calibrating the meter needle to the "SET" position with the RF POWER control, then setting this switch to the SWR position.

7. AF GAIN CONTROL

Controls the audio output level in the receive mode. Clockwise rotation increases the level.

8. RF GAIN CONTROL

Controls the gain of the RF section in the receive mode. Clockwise rotation gives the maximum gain. As the control is rotated counterclockwise, the needle of the MULTI-FUNCTION METER rises, and only signals stronger than the level indicated by the needle will be heard. (In the FM mode, regardless of the control setting, the RF gain is fixed at the maximum.)

9. SQUELCH CONTROL

Sets the squelch threshold level. To turn OFF the squelch function, rotate this control completely counterclockwise. To set the threshold level higher, rotate the control clockwise.

10. TONE CONTROL

Controls the receiver audio tone. Adjust the control to provide comfortable reception.

11. MIC GAIN CONTROL

Adjusts the level of modulation according to the input of the microphone. Clockwise rotation increases the microphone gain. As the input will vary with different microphone and different voices, the knob should be turned until the Meter needle, in the ALC mode, begins to move slightly within the ALC zone. In the SSB mode when the speech processor is in use, the MIC GAIN CONTROL sets a clipping limit, while the RF POWER CONTROL sets the RF drive level to the maximum power level, where ALC starts at the saturation point of the amplifiers.

12. RF POWER CONTROL

Controls the RF output power 10 Watts to maximum (SSB: 100 Watts PEP, CW, RTTY, FM: 100 Watts, AM: 40 Watts). Clockwise rotation increases the output power.

13. HAM BAND/GENERAL COVER SELECT SWITCH

Each push selects the function of the set alternately. In the HAM BAND mode, the transceiver functions in any of nine

HAM bands between 1.8MHz and 28MHz. In the GENERAL COVERAGE mode the set functions as a general coverage receiver between 0.1MHz and 30MHz. (The set will not transmit in this mode.)

14. SPEECH SYNTHESIZER SWITCH

When the optional speech synthesizer unit is installed, this switch turns on the unit which announces the displayed frequency in English.

15. MODE SELECTIVE SCAN SWITCH

When this switch is pushed, only memory channels stored with the operating mode which is displayed on the frequency display just prior to pushing this switch, are selected by turning the tuning control or scanning.

16. SCAN START/STOP BUTTON

Starts and stops any of the scan functions. When depressing it again to restart the scan, it will start from the stopped frequency in the programmed scan, or from the highest memory channel in the other memory scans.

17. DIAL LOCK SWITCH

After the IC-751 is set to a certain frequency for rag chewing, mobile operation, etc., by pushing this switch, the VFO is electronically locked at the display frequency, thus inactivating the operation of the tuning control. To change frequency, the dial lock must first be disengaged by pushing and releasing this switch again.

18. TUNING CONTROL

Rotating this control clockwise increases the frequency or the memory channel number, while rotating it counterclockwise decreases it. The frequency changes by 10Hz in any mode. In 10Hz step tuning rate, by turning the tuning control faster, the 50Hz step tuning rate is automatically selected. This makes it very convenient to make a QSY over a wide frequency range.

This control is also used to select the operating band while the BAND SELECT FUNCTION switch is depressed.

19. TUNING RATE SWITCH

By pushing in this switch, the operating frequency is changed to correspond to 1KHz increments in any mode.

At the same time, the 100Hz digit on the display is cleared to show "0". When this switch is pushed again and released, the frequency is changed normally. This switch allows you to quickly QSY over a great frequency range.

20. DIAL FUNCTION SELECT SWITCH

In the VFO operation, by pushing in this switch, the operating frequency (displayed VFO frequency) is locked and the memory channel number (displayed on the frequency display) can be changed by turning the tuning control.

In the MEMORY CHANNEL mode, by pushing in this

switch, the memory channel is locked and the operating frequency (displayed frequency) can be changed by turning the tuning control.

21. BAND SELECT FUNCTION SWITCH

By pushing in this switch, the operating band is changed by turning the TUNING CONTROL.

In the HAM BAND mode, each initialized frequency of the band is selected. In the GENERAL COVERAGE mode, the operating frequency is changed in 1MHz steps but the lower digits do not change.

22. INCREMENTAL TUNING CONTROL

Shifts the receive frequency 9.9KHz (maximum) to either side of the transmit frequency when the RIT is ON, and shifts the transmit frequency to either side of the receive frequency when the XIT is ON.

Rotating this control clockwise (+ side) raises the receive or transmit frequency and counterclockwise (- side) lowers the frequency with 10Hz steps, and 1KHz and 100Hz digits of the frequency shifted are displayed on the frequency display.

When both the RIT and XIT switches are ON, the receive and transmit frequencies are the same, and this frequency can be shifted either side from the displayed frequency by the control.

23. RIT SWITCH

Switches the RIT (Receiver Incremental Tuning) circuit ON and OFF.

To turn ON the RIT, push this button once. At this time, the letters "RIT" and shifted frequency are displayed on the frequency display. If you desire to turn OFF the RIT, push the button again. The letters "RIT" and shifted frequency are no longer displayed, however, the shifted frequency is stored in the memory and if you turn ON the RIT again, the shifted frequency appears on the display again.

24. XIT SWITCH

Switches the XIT (Transmitter Incremental Tuning) circuit ON and OFF.

To turn ON the XIT, push this button once. At this time, the letters "XIT" and shifted frequency are displayed on the frequency display. The other functions are in like manners.

25. RIT/XIT CLEAR BUTTON

By pushing this button, a frequency shifted by turning the INCREMENTAL TUNING control is cleared to "0.0".

When pushing the FUNCTION KEY first, then this button, the shifted frequency is added to the displayed one, and the shifted frequency is cleared to "0.0".

26. FILTER SWITCH

Selects the combination of the second IF (9MHz) filter and the third IF (455KHz) filter to improve the selectivity.

27. NOTCH FILTER SWITCH

Switches the notch filter function ON and OFF.

28. P.B. TUNE (PASS BAND TUNING) CONTROL

Allows continuous tuning of the pass-band selectivity by moving the filter up to 800Hz from the upper or lower side in SSB, CW and RTTY. Not only improves selectivity, but also can improve the audio tone. Normal position is in the center (12 o'clock) position and is 2.3KHz wide in SSB.

29. NOTCH FILTER CONTROL

Shifts the notch filter frequency. Adjust the control so that the interference is reduced.

30. COMP (SPEECH PROCESSOR) SWITCH

Switches the speech processor circuit ON and OFF. This circuit enables greater talk power and better results in DX operation.

31. MONITOR SWITCH

In the SSB transmit mode, the transmitting IF signals can be monitored by turning this switch ON. At this time, use headphones or reduce receiver audio volume to prevent howling.

This switch also turns the CW side-tone circuit ON and OFF in the CW mode.

32. NB TIMING SWITCH

The noise blanker blanking time can be selected NORMAL and WIDE by this switch. It will be effective against any types of noises.

33. VOX GAIN CONTROL

When the control is turned completely counterclockwise, the VOX circuit is OFF. By turning the control clockwise beyond the "click", the VOX circuit is turned ON and the VOX gain increases by further rotating it clockwise.

When the VOX is turned ON, in SSB, AM or FM, T/R switching is accomplished by means of a voice signal. In CW operation, semi-break-in or full-break-in switching by means of keying possible.

For VOX operation in SSB, AM or FM, adjust the control so that the VOX circuit will operate with normal speech.

34. VOX DELAY (VOX time constant) CONTROL

This controls the transmit to receive switching time. Adjust it so transmit to receive switching will not occur during short pauses in normal speech.

In the CW operation, adjust this control to suit your keying speed. If the control is set at the "FULL" (completely counterclockwise) position, it will reach full-break-in CW.

35. NB LEVEL CONTROL

Controls the threshold level of the noise blanker. Adjust the control so that incoming noises will be disappeared.

36. FUNCTION KEY

Increases the function of the MODE SELECT switches, MEMORY WRITE button, FREQUENCY TRANSFER button and RIT/XIT CLEAR button by pushing this key switch first.

37. FUNCTION KEY INDICATOR

This indicator is lit by pushing the FUNCTION KEY to indicate the second function will be selected, and turned off by pushing one of the dual function switches or buttons.

38. MODE SELECT SWITCHES

Selects any one of four operating modes by simply pushing the desired switch. Additionally, these switches have dual functions as follows.

1. AM For AM operation.

FM Pushing the FUNCTION KEY first, then the AM switch, the FM mode is selected.
2. CW For normal CW operation.

NARROW Pushing the FUNCTION KEY first, then the CW switch when the optional 455KHz narrow CW filter is installed. (No sound can be heard when the optional filter is not installed.)
3. SSB Upper sideband (USB) for 10MHz band and above, and lower sideband (LSB) for 7MHz (in the GENERAL COVERAGE operation: 9MHz) band and below (normal SSB operation) will be selected.

REVERSE Lower sideband (LSB) for 10MHz band and above, and upper sideband (USB) for 7MHz (in the GENERAL COVERAGE operation: 9MHz) band and below will be selected.

4. RTTY For normal RTTY operation.

NARROW Pushing the FUNCTION KEY first, then the RTTY switch, filter is switched to the narrow CW filter when the optional 455KHz narrow CW filter is installed. (No sound can be heard when the optional narrow CW filter is not installed.)

39. MULTI-FUNCTION METER

When in the receive mode the meter acts as an S-meter regardless of the position of the meter switch. Signal strength is indicated on a scale of S1-S9, and S9 to S9+60dB.

In the transmit mode the meter has six functions which are selected by the Meter Switch (6).

40. TRANSMIT INDICATOR

Illuminates when the transceiver is in the transmit mode.

41. RECEIVE INDICATOR

Illuminates when the squelch is opened in the receive mode.

42. NARROW INDICATOR

Illuminates when the set is on CW-Narrow or RTTY-Narrow mode. This indicator illuminates not only when the optional CW filter is installed, but also if it is not installed.

43. FREQUENCY DISPLAY

The frequency of the IC-751 is displayed on a luminescent display tube. Since the 1MHz and 1KHz decimal points are displayed, the frequency can easily be read. The frequency indicated is the carrier frequency of each mode in, USB, LSB, CW, AM and FM, and the mark frequency in RTTY.

The FREQUENCY DISPLAY shows not only the operating frequency but also mode, duplex (split frequency) mode, selected VFO or memory channel, RIT/XIT functions and their shifted frequency, and the set is in SCAN mode and in HAM band or GENERAL COVERAGE mode.

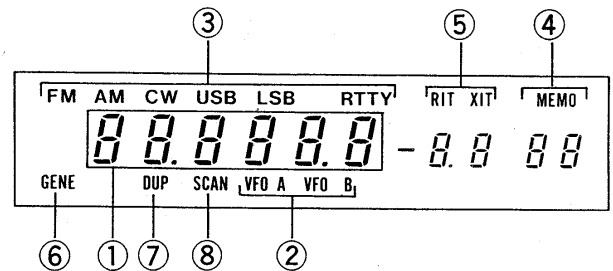

- ① Shows operating frequency in 6 digits between 10MHz and 100Hz.
- ② Shows selected VFO; VFO A or VFO B.
- ③ Shows operating mode; one of FM, AM, CW, USB, LSB, and RTTY.
- ④ Shows that the set is in the MEMORY CHANNEL MODE or not, and the selected memory channel number. When the set is in the MEMORY CHANNEL MODE, the letters "MEMO" are displayed here.
- ⑤ Shows that the RIT and XIT are ON or OFF, and their shifted frequency.

When the RIT and/or XIT are ON, the letters "RIT" and/or "XIT" are displayed here.

When both the RIT and XIT are OFF, any letters and shifted frequency are no longer displayed.

- ⑥ Shows that the set is in the HAM BAND mode or GENERAL COVERAGE mode.

When the set is in the GENERAL COVERAGE mode, the letters "GENE" are shown here.

- ⑦ Shows that the set is in the DUPLEX (SPLIT FREQUENCY) mode or not. When the set is in the DUPLEX mode, the letters "DUP" are displayed here.
- ⑧ Shows that the set is in the SCAN mode or not. When the set is in the SCAN mode, the letters "SCAN" are displayed here.

44. VFO SWITCH

Selects either VFO, "A" or "B", for tuning. Each push of this button selects VFO A and B alternately.

45. VFO EQUALIZING SWITCH

Instantly sets the frequency, mode and HAM/GENE operation of a VFO to the same as those of the other VFO.

46. DUPLEX (SPLIT) SWITCH

Selects the relationship of the two VFO's. In the OFF position, one VFO is for both receive and transmit. By pushing in this switch, one VFO is for receive and the other VFO is for transmit.

47. VFO/MEMORY SWITCH

Switches the VFO operation and MEMORY CHANNEL operation.

48. MEMORY WRITE BUTTON

By pushing this button, a displayed frequency, mode and HAM/GENE operation are stored into a memory channel displayed on the frequency display.

49. FREQUENCY TRANSFER BUTTON

In the VFO operation, the frequency, mode and HAM/GENE operation stored in a memory channel (displayed its channel number on the frequency display), are transfer to the selected VFO.

4 - 2 TOP COVER

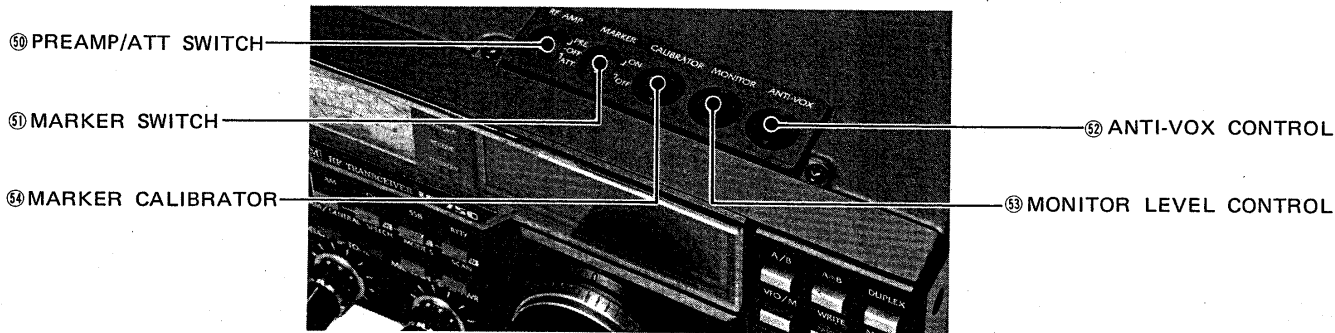

50. PREAMP/ATT (Attenuator) SWITCH

Switches RF preamplifier and attenuator in the RF circuit.

When the switch is in the OFF position, both preamplifier and attenuator are removed from the circuit, and incoming signals will be fed to the receiver directly.

When using a small antenna or receiving a weak signal, set the switch in the "PRE" position, and the preamplifier is put in the RF circuit and provides higher sensitivity.

When nearby signals interfere with reception, or receiving a very strong signal, set this switch in the "ATT" position. This removes the preamplifier from the circuit and inserts the attenuator into the circuit. This gives about 20dB attenuation.

For normal operation leave this switch in the "OFF" position.

51. MARKER SWITCH

Turns the marker circuit ON or OFF. The marker frequency is available on every 10KHz.

52. ANTI-VOX CONTROL

In VOX operation, the VOX circuit may be operated by sound from the speaker causing a switch to transmit. This trouble can be prevented by adjusting the input level of the ANTI-VOX circuit with this control along with the VOX gain control so that the VOX circuit only operates by the operator's voice, not by sound from the speaker.

53. MONITOR LEVEL CONTROL

Controls the audio level of the monitoring SSB or CW side-tone when the MONITOR switch on the front panel is turned ON. Adjust the control for comfortable monitoring.

54. MARKER CALIBRATOR

Calibrates the marker frequency with a standard frequency such as the WWV.

4 - 3 REAR PANEL CONNECTIONS

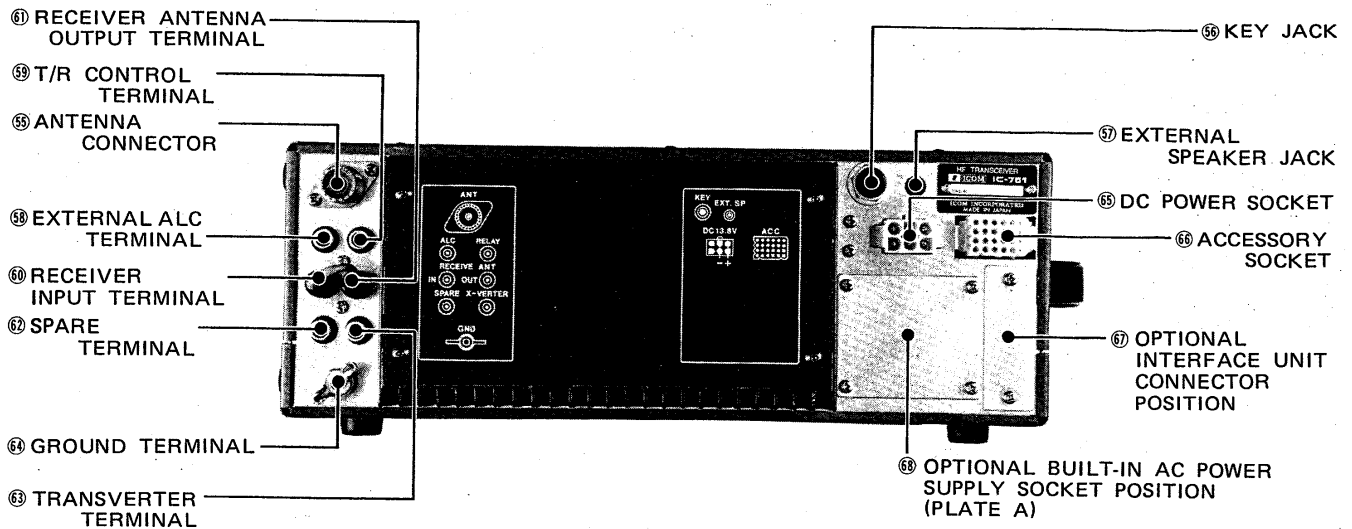

55. ANTENNA (ANT) CONNECTOR

This is used to connect an antenna to the set. Its impedance is 50 ohms and connect with a PL-259 connector.

56. KEY JACK

For CW operation, connect a key here using a standard 1/4 inch plug. For electronic keying the terminal voltage must be less than 0.4V DC.

57. EXTERNAL SPEAKER JACK

When an external speaker is used, connect it to this jack. Use a speaker with an impedance of 8 ohms. When the external speaker is connected, the built-in speaker does not function.

58. EXTERNAL ALC TERMINAL

This terminal can be used for input terminal of external ALC signal from a linear amplifier or transverter. The ALC voltage should be in 0V ~ -4V.

59. T/R CONTROL TERMINAL

Controls Transmit/Receive for an external linear amplifier or transverter. This terminal can be used to switch 24V 1A DC. Don't exceed this limit.

60. RECEIVER INPUT TERMINAL

This is an input terminal which is connected directly to the receiver.

61. RECEIVER ANTENNA OUTPUT TERMINAL

This is a terminal to which received signals from the antenna connector are conducted after the signal passes through the transmit/receive antenna switching circuit. Usually the receiver IN and OUT terminals are jumpered. The receiver antenna output terminal is usually used when another receiver is used or a preamplifier is connected to the IC-751.

62. SPARE TERMINAL

This terminal is available for your personal use, such as for adding accessory circuit, etc., if desired.

63. TRANSVERTER TERMINAL

VHF and UHF operation using a suitable transverter with the IC-751 is possible. This terminal is for Transverter connection. The output is about 30mV.

64. GROUND TERMINAL

To prevent electrical shock, TVI, BCI and other problems, be sure to ground the equipment through the GROUND TERMINAL. For best results use as heavy a gauge wire or strap as possible and make the connection as short as possible, even in mobile installations.

65. DC POWER SOCKET

For connection of the IC-PS15's DC power cord, or other suitable power supply.

66. ACCESSORY (ACC) SOCKET

Various functions are available through the accessory socket such as modulation output, receiver output, T/R change-over, and so forth. Refer to the ACCESSORY SOCKET CONNECTION on page 5.

67. OPTIONAL INTERFACE UNIT CONNECTOR POSITION

This is provided to install the DP-25 connector of the optional interface unit.

68. OPTIONAL BUILT-IN AC POWER SUPPLY SOCKET POSITION

This is provided to install AC power socket plate of the optional built-in AC power supply, IC-PS35.

SECTION 5 OPERATING INSTRUCTIONS

5-1 HOW TO TUNE

The following instructions are for tuning in any mode. Please read carefully and understand fully before turning ON your unit. Proper tuning is necessary for optimum operation.

5-1-1 PRESET

When the power switch is turned ON, the frequency display shows frequency, HAM/GENE (HAM BAND mode or GENERAL COVERAGE mode) mode and mode stored in the VFO A, letters "VFO A" and "01" representing memory channel 1, and the set operates with the VFO A and displayed mode, even if the previous operating mode was different. In addition, the RIT/XIT, DUPLEX mode and SCAN are turned OFF.

FOR EXAMPLE:

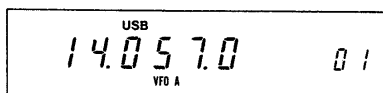

5-1-2 HAM BAND/GENERAL COVERAGE SELECTION

Each push of the HAM/GENERAL COVER SELECT switch changes the set in the HAM BAND MODE and GENERAL COVERAGE MODE alternately.

In the HAM BAND MODE, the frequencies available are those of the nine amateur bands between 1.8MHz and 28MHz including new three bands for both transmit and receive.

In the GENERAL COVERAGE MODE, the set operates as a receiver in the range of 0.1MHz to 30MHz continuously.

When you change the mode from the HAM BAND to GENERAL COVERAGE, the set maintains the frequency that was in the HAM BAND mode.

When you change the mode from the GENERAL COVERAGE to HAM BAND, if previous frequency was that of a HAM BAND, the set maintains that frequency.

FOR EXAMPLE:

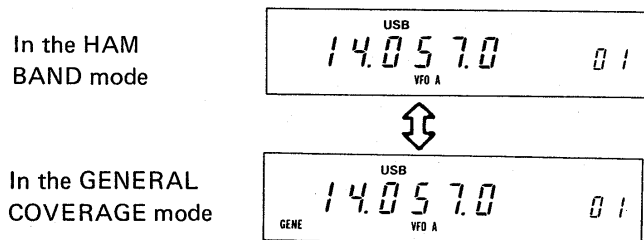

If the previous frequency was not of any HAM BAND, the frequency is initialized to "1.900.0MHz".

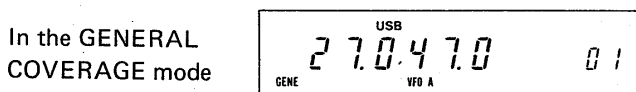

Pushing the HAM/
GENERAL COVER SELECT
switch



In the HAM
BAND mode

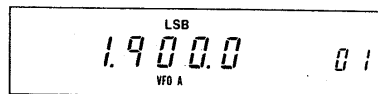

5-1-3 BAND SWITCHING

To change the operating band, push the BAND SELECT FUNCTION switch in and rotate the TUNING CONTROL.

In the HAM BAND mode, by turning the TUNING CONTROL clockwise the operating band changes to the next upper band, and counterclockwise changes to the next lower band, and the operating frequency is initialized as follows.

| Band | Displayed Frequency (MHz) | | |
|--------|---------------------------|----------|----------|
| | LSB·AM·FM | CW·RTTY | USB |
| 1.8MHz | 1.900.0 | 1.899.4 | 1.897.0 |
| 3.5 | 3.550.0 | 3.549.4 | 3.547.0 |
| 7 | 7.050.0 | 7.049.4 | 7.047.0 |
| 10 | 10.050.0 | 10.049.4 | 10.047.0 |
| 14 | 14.050.0 | 14.049.4 | 14.047.0 |
| 18 | 18.050.0 | 18.049.4 | 18.047.0 |
| 21 | 21.050.0 | 21.049.4 | 21.047.0 |
| 24.5 | 24.550.0 | 24.549.4 | 24.547.0 |
| 28 | 28.050.0 | 28.049.4 | 28.047.0 |

In the GENERAL COVERAGE mode, by turning the TUNING CONTROL clockwise the operating frequency changes to a frequency that is added 1MHz to the previous one. (100KHz and lower digits of the frequency will remain as it had in the previous one.) By turning the TUNING CONTROL counterclockwise, the operating frequency changes to a frequency that is subtracted 1MHz from the previous one.

When the band reaches to the highest one in either mode, it will automatically return to the lowest one, or vice versa, as per the following charts.

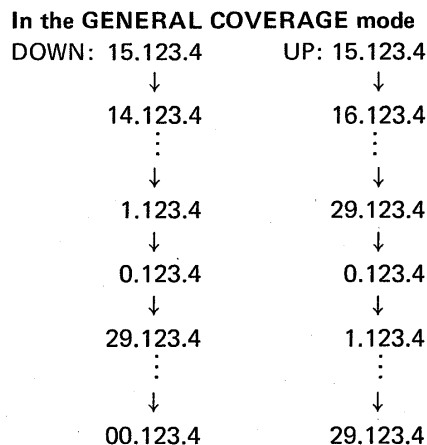

In the HAM BAND mode

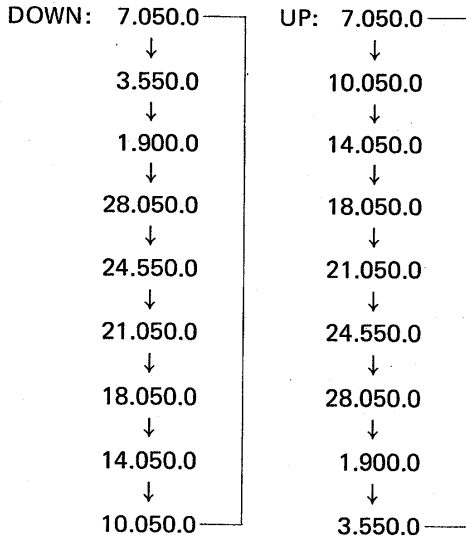

However, in the GENERAL COVERAGE mode, when the operating frequency reaches the highest or lowest edge, of that MHz range by turning the TUNING CONTROL continuously (at this time the BAND SELECT FUNCTION switch is not pushed in), the operating frequency will go to the next MHz range.

5 - 1 - 4 FREQUENCY DISPLAY ON EACH MODE

When the 7MHz band and LSB are selected, the display will be as follow:

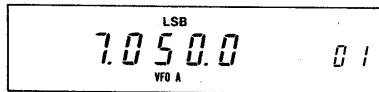

When changing to other modes, the display will be as follows:

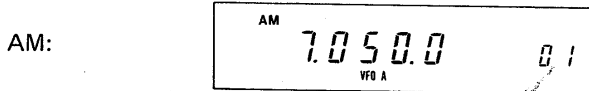
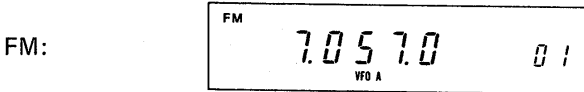
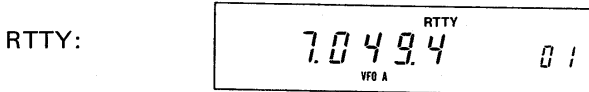
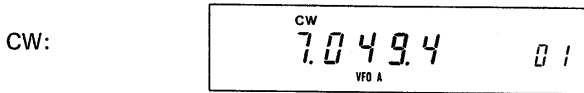
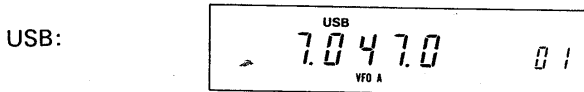

The displayed frequency shows the carrier frequency. To avoid the trouble of recalibrating the dial when you change the operating mode, the displayed frequency is set to shift to the carrier frequency of each mode automatically. For the differences of frequency shifts of the various modes, refer to the following figure.

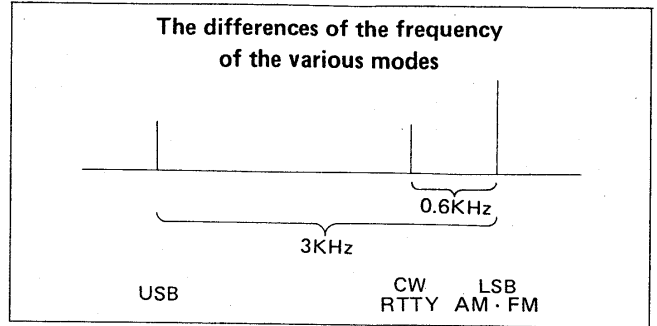

In the HAM BAND SSB mode, the sideband will be automatically selected to the one usually used on the band, i.e., upper sideband (USB) for the 10MHz band and above, and lower sideband (LSB) for the 7MHz band and below. If reverse sideband is desired, push the FUNCTION key first, then push the SSB switch.

5 - 1 - 3 TUNING CONTROL

Rotating the TUNING CONTROL clockwise increases the frequency, while turning counterclockwise decreases the frequency in 10Hz steps. By turning the tuning control faster, the 50Hz steps tuning rate is automatically selected.

When the TUNING RATE switch is pushed in, the 1KHz steps tuning rate is selected in any mode. At this time, the 100Hz digit of the frequency display is cleared to "0".

The frequency range of each band in the HAM band mode is shown in the following chart.

| Band | Frequency Range |
|------|---------------------|
| 1.8 | 1.800.0 ~ 1.999.9 |
| 3.5 | 3.440.0 ~ 4.099.9 |
| 7.0 | 6.950.0 ~ 7.499.9 |
| 10.0 | 9.950.0 ~ 10.499.9 |
| 14.0 | 13.950.0 ~ 14.499.9 |
| 18.0 | 17.950.0 ~ 18.499.9 |
| 21.0 | 20.950.0 ~ 21.499.9 |
| 24.0 | 24.450.0 ~ 25.099.9 |
| 28.0 | 27.950.0 ~ 29.999.9 |

In the HAM BAND mode, by turning the TUNING CONTROL clockwise, the operating frequency reaches to the high edge of the band (for example; 14.499.9MHz), and further turning of the control brings the frequency to the low edge of the band (13.950.0MHz) then continues up the frequency from there. Likewise, by continuing to turn the TUNING CONTROL counterclockwise beyond the low edge of the band, the frequency jumps up to the high edge and goes down from that frequency.

In the GENERAL COVERAGE mode, by turning the TUNING CONTROL clockwise, the operating frequency reaches the highest one of that MHz range (for example; 14.999.9

MHz), and further turning of the control brings the frequency to the next upper MHz range (15.000.0MHz) and continues up the frequency from there. By turning the control counterclockwise, the operating frequency changes in like manner to the next lower MHz range.

Brake Adjustment

If the control is too loose or too stiff for comfortable use, you can adjust the torque by tightening or loosening the brake adjustment screw accessible from underneath the set.

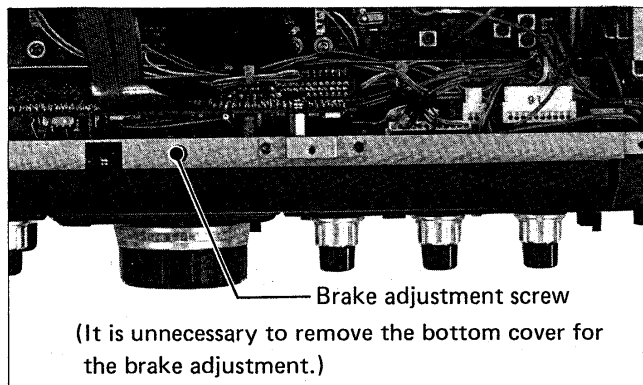

The following instructions should be used to adjust the tension of the Tuning control.

1. The Tuning control tension will become tighter by turning the brake adjustment screw clockwise, and will become looser by turning the screw counterclockwise.
2. While performing this adjustment, the Tuning control must be turned continuously as the screw is adjusted in order to set the tension for a comfortable touch.

NOTE: When the letters "VFO A" or "VFO B" are displayed on the frequency display, we call this condition as "VFO MODE", when the letters "MEMO" are displayed above the memory channel number, we call as "MEMORY CHANNEL MODE".

These can be changed by pushing the VFO/MEMORY switch alternately.

5-1-6 DIAL LOCK SWITCH

After the IC-751 is set at a certain frequency for rag chewing, mobile operation, etc., by pushing the Dial Lock switch the VFO is locked at the displayed frequency, thus inactivating the operation of the tuning control. To change the frequency, the Dial Lock must first be disengaged by pushing and releasing the Dial Lock switch again.

5-1-7 VFO SWITCH

The IC-751 contains two VFO's for both receiving and transmitting. The VFO's are labeled "VFO A" and "VFO B", and are selectable by pushing the VFO switch alternately in the VFO MODE. The dual VFO system gives the IC-751 many very convenient features. Please read this

section very carefully and perform the operation several times until you are comfortable with the system. Try the example for practice!

1. "VFO A" is for both receiving and transmitting, and selected by pushing the VFO switch. The receive and transmit frequency will be controlled by the "VFO A", displayed on the frequency display, and stored in the "A" memory.
2. "VFO B" is for both receiving and transmitting, and selected by pushing the VFO switch. The receive and transmit frequency will be controlled by the "VFO B", displayed on the frequency display, and stored in the "B" memory.

Switching from one VFO to the other VFO does not clear the first VFO. The frequency, operating mode and HAM/GENE mode are retained in the VFO's memory.

FOR EXAMPLE:

If 14.252MHz and USB are set with the "VFO A", then the VFO switch is pushed to select the "VFO B", the frequency display will show VFO B's frequency and mode, but 14.257MHz and USB are still stored in the VFO A's memory.

Pushing the VFO switch again to return the VFO A, "14.257.0" and "USB" will be displayed on the frequency display.

Accordingly, if the VFO switch is pushed again to the VFO B, the frequency and mode that were set with the VFO B will appear.

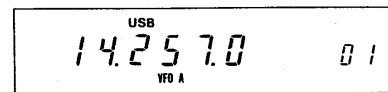

Pushing the VFO switch to select the VFO B.

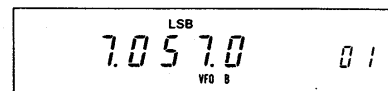
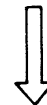

Pushing the VFO switch again to return the VFO A.

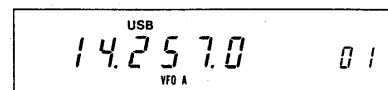
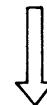

This allows you to set a certain frequency with one VFO, work up and down the band with the other VFO, and periodically check the set frequency simply by switching between VFO "A" and "B".

It also allows you to search for a clear frequency with one VFO, while keeping your operating frequency on the other VFO. When you have found a clear frequency, switch back to your operating frequency, inform the station you are in contact with of the new frequency, and switch back. It's that simple!

5-1-8 DUPLEX (SPLIT) SWITCH

The DUPLEX (SPLIT) switch changes the relationship of the two VFO's. Each push turns the function ON and OFF alternately.

When the function is OFF, one VFO is for both receive and transmit. When the function is ON, the letters "DUP" are displayed on the frequency display, and one VFO is for receive and the other VFO is for transmit. So that this will allow you to operate on split receive/transmit frequencies.

FOR EXAMPLE:

Set VFO A to 7.057MHz and VFO B to 7.255MHz. Push the VFO switch to return VFO A then the DUPLEX (SPLIT) switch to ON. 7.057MHz will be shown on the display during receive (VFO A) and 7.255MHz during transmit (VFO B). You are now receiving on 7.057MHz and transmitting on 7.255MHz. Pushing the VFO switch to reverse the above.

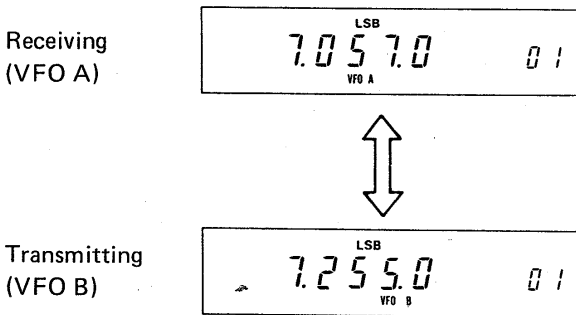

Each VFO stores operating mode too. If different mode is stored in each VFO, a crossmode QSO can be possible as well.

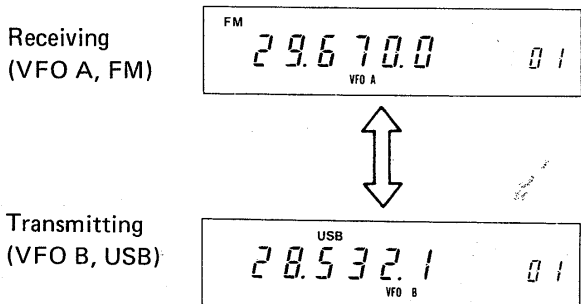

5-1-9 TRANSFERRING VFO FREQUENCY

The VFO EQUALIZING switch allows either VFO's to be brought to the exact frequency of the other VFO without turning the tuning control, and the operating mode.

FOR EXAMPLE:

When VFO A is 14.271MHz and USB, and VFO B is 29.670MHz and FM, pushing the VFO switch to select VFO A, then the VFO EQUALIZING switch, VFO B's frequency and operating mode become the same as VFO A's (14.271MHz and USB). Now the VFO A's frequency is memorized in the VFO B, and you can operate anywhere with VFO A or B. When you want to return to the previous frequency (14.271MHz), switch back to the other VFO. To reverse this (A the same as B), select VFO B first, then the VFO EQUALIZING switch.

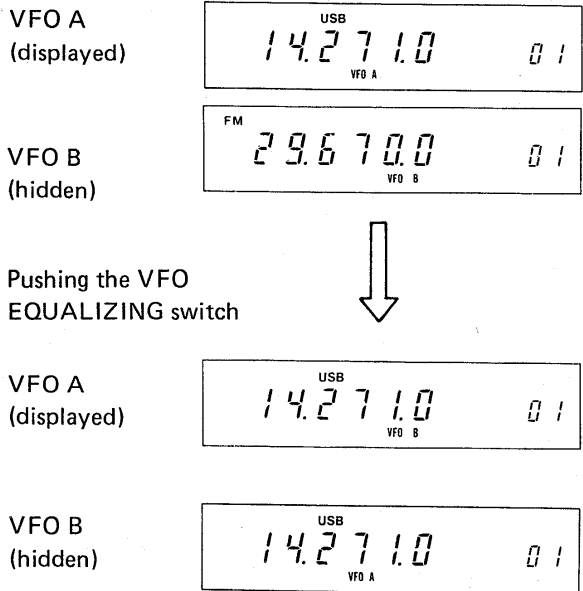

5-1-10 RIT (RECEIVE INCREMENTAL TUNING)

By using the RIT circuit, you can shift the receive frequency 9.9KHz (maximum) either side of the transmit frequency without moving the transmit frequency itself. Therefore, when you get a call slightly off frequency, or when the other station's frequency has been drifted, you can tune in the frequency without disturbing the transmitting frequency.

By pushing the RIT switch, the RIT circuit is turned ON and the letters "RIT" and shifted frequency are displayed on the frequency display.

The receive frequency can be shifted 10Hz steps by turning the INCREMENTAL TUNING CONTROL.

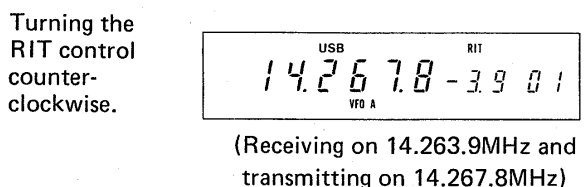
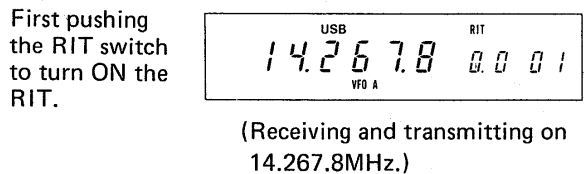

Rotating the control to the (+) direction raises the receiving frequency, and to the (-) direction lowers one.

To turn OFF the RIT function, push again the RIT switch and the letters "RIT" and shifted frequency displayed on the frequency display are no longer displayed. When the RIT circuit is OFF, the transmit and receive frequencies are the same regardless of the shifted frequency. However, the shifted frequency is stored in the memory and it will reappear when the RIT switch is pushed again.

Pushing the RIT switch to turn OFF the RIT.

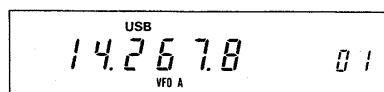

Pushing the RIT switch again to turn ON the RIT.

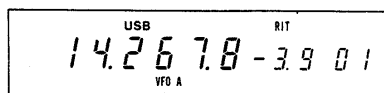

To clear the shifted frequency, push the RIT/XIT CLEAR button and the shifted frequency becomes "0.0" (The receive and transmit frequencies become the same.), regardless the RIT circuit is turned ON or OFF.

Pushing the RIT/XIT CLEAR button.

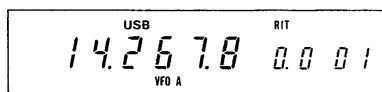

If you want to change the operating frequency (displayed frequency) to the receive frequency which is shifted by the RIT function, push the FUNCTION KEY first then the RIT/XIT CLEAR button, and the shifted frequency is added to the previous displayed frequency and the operating frequency is changed to the previous receive frequency. At the same time the shifted frequency is cleared to "0.0" and the set operates on the new displayed frequency for both the transmitting and receiving.

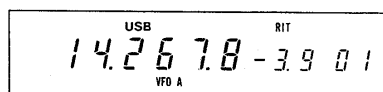

Pushing the RIT/XIT CLEAR button.

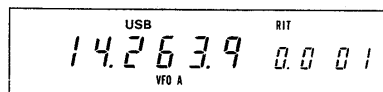
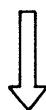

NOTE: The RIT circuit is operational when the frequency has been locked with the DIAL LOCK button as well as in the MEMORY CHANNEL MODE.

When the transmitting and receiving frequencies differ by more than 10KHz, use VFO A and B in the DUPLEX (SPLIT) mode.

5 - 1 - 11 XIT (TRANSMIT INCREMENTAL TUNING)

By using the XIT circuit, you can shift the transmit frequency 9.9KHz (maximum) either side of the receive frequency without moving the receive frequency itself in like manner as the RIT function.

By pushing the XIT switch, the XIT circuit is turned ON and the letters "XIT" and shifted frequency are displayed on the frequency display. The transmit frequency can be shifted 10Hz steps by turning the INCREMENTAL TUNING CONTROL.

First pushing the XIT switch to turn ON the XIT.

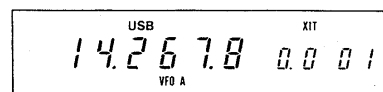

(Receiving and transmitting on 14.267.8MHz.)

Turning the INCREMENTAL TUNING control counterclockwise.

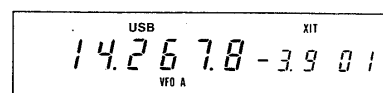

(Receiving on 14.267.8MHz and transmitting on 14.263.9MHz)

If the RIT has been turned ON before and the shifted frequency is stored in its memory (now the RIT is OFF), then the XIT is turned ON, the shifted frequency stored in the RIT memory is reappeared on the display and it becomes the shifted frequency of the XIT.

The RIT has been turned ON.

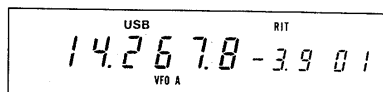

(Receiving on 14.263.9MHz and transmitting on 14.267.8MHz.)

Pushing the RIT switch to turn OFF the RIT.

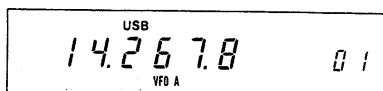

(Receiving and transmitting on 14.267.8MHz.)

Pushing the XIT switch to turn ON the XIT.

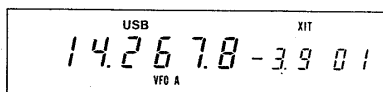

(Receiving on 14.267.8MHz and transmitting on 14.263.9MHz.)

If you push the XIT switch to turn the XIT ON when the RIT has been turned ON already, the XIT is also turned ON, however, its shifted frequency will be the same as that of the RIT. So the set will operate on the same frequency which is shifted from the displayed frequency and it can be changed by turning the INCREMENTAL TUNING CONTROL, in both the transmitting and receiving.

The RIT has been turned ON already.

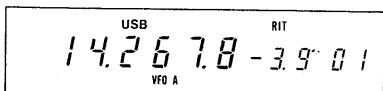

(Receiving on 14.263.9MHz and transmitting on 14.267.8MHz.)

Pushing the XIT switch to turn ON the XIT.

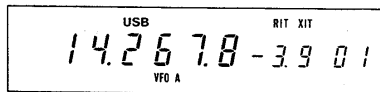

(Receiving and transmitting on 14.263.9MHz.)

To turn OFF the XIT function, push again the XIT switch and the letters "XIT" and shifted frequency displayed on the frequency display are no longer displayed. (If the RIT is ON the shifted frequency will remain.) When the XIT circuit is OFF, the transmit and receive frequencies are the same regardless of the shifted frequency. However, the shifted frequency is stored in the memory and it will be reappear when the XIT switch is pushed again.

Pushing the XIT switch to turn OFF the XIT.

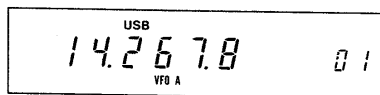

Pushing the XIT switch again to turn ON the XIT.

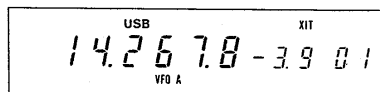

To clear the shifted frequency or to add the shifted frequency to the displayed one, you can make it in like manner as the RIT.

5 - 1 - 12 DIAL FUNCTION SELECT SWITCH (IN VFO MODE)

In the VFO mode, by pushing the DFS (DIAL FUNCTION SELECT) switch in, the operating frequency locked on the displayed frequency and by turning the TUNING CONTROL, the MEMORY CHANNEL NUMBER displayed on the frequency display can be changed. This is very convenient to memorize the operating frequency and modes into a memory channel, or to change the operating frequency and modes to ones in a memory channel.

FOR EXAMPLE:

Now you are operating on 14.271MHz and USB, and memory channel number "7" is displayed. If you want to memorize these into the memory channel 27, push the DFS switch in and you can change the displayed memory channel number by turning the tuning control.

Turn the tuning control to obtain the desired memory channel number (at this time "27"), then push the MEMORY WRITE button, and the operating frequency "14.271MHz" and mode "USB" are memorized into the memory channel 27. To change the operating frequency again, push and release the DFS switch.

On the display

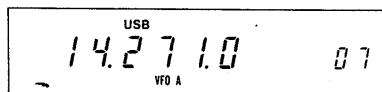

Pushing the DFS switch and turning the TUNING CONTROL.

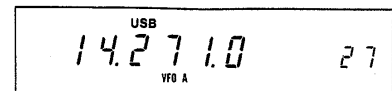
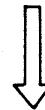

By pushing the MEMORY WRITE button, the frequency and mode are memorized into the MEMORY CHANNEL 27.

FOR EXAMPLE:

Now you are operating on 14.271MHz USB and memory channel 7 memorizes "29.625MHz" and "FM". If you wish to operate with the frequency and modes which are memorized in the memory channel 7, push the DFS switch in and turn the tuning control to be displayed memory channel number "7". Then push the FREQUENCY TRANSFER button, and "29.625.0" and "FM" are appeared on the frequency display. Now you can operate on these frequency and mode, and by pushing and releasing the DFS switch, the displayed frequency can be changed by turning the tuning control.

On the display

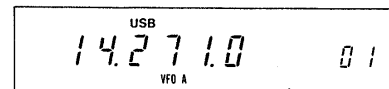

Contents of the memory channel 7 (hidden)

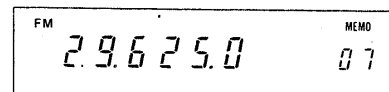

Pushing the DFS switch and turning the TUNING CONTROL.

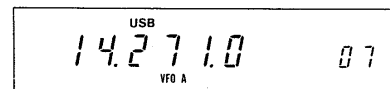

Pushing the FREQUENCY TRANSFER button.

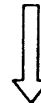

The contents of the channel 7 are transferred to the VFO A.

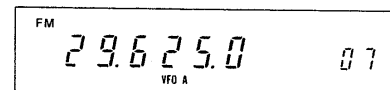

5 - 2 MEMORY CHANNEL OPERATION

5 - 2 - 1 MEMORY CHANNEL SELECTION

When the power switch is turned ON, the set initially operates with the VFO A and memory channel number "01" is displayed. By pushing the VFO/MEMORY switch, the set is switched into the MEMORY CHANNEL MODE and frequency, mode and HAM/GENE mode which have been stored in the "MEMORY CHANNEL 1" are displayed

on the frequency display. In addition, the letters "MEMO" are also displayed above the memory channel number to indicate the set is in the MEMORY CHANNEL MODE.

FOR EXAMPLE:

When "14.271MHz" and USB are memorized in VFO A, and "29.625MHz" and "FM" are in MEMORY CHANNEL 1, by pushing the power switch ON, the frequency display shows "14.271.0", "USB", "VFO A" and memory channel number "01".

By pushing the VFO/MEMORY switch, the display will show "29.625.0" and "FM", memory channel number "01", and the letters "MEMO" above the channel number.

When the power is turned ON.

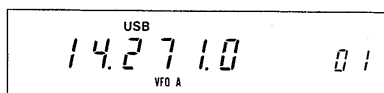

Pushing the VFO/MEMORY switch

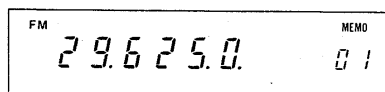
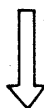

By turning the TUNING CONTROL, memory channels can be selected. Turning clockwise increases the channel number and counterclockwise decreases the number, and the respective frequency, mode and HAM/GENE mode are displayed on the display.

When you select a memory channel that has never been stored any frequency, the frequency display does not show any frequency, but MHz and KHz decimals. However, the set works with the frequency and mode of the memory channel (or VFO), which was previously displayed.

FOR EXAMPLE:

When "7.012MHz" and "CW" are memorized in memory channel 2, and no frequency is in channel 3, by turning the TUNING CONTROL clockwise, the frequency display will show "7.012.0" "CW", "MEMO" and memory channel number "02".

By turning the TUNING CONTROL clockwise furthermore, the memory channel number will change to "03", but the channel has never memorized any frequency, thus the display shows "CW" and only the MHz and KHz decimals. However, the set works with the frequency and mode of channel 2, i.e., "7.012MHz" and "CW".

When memory channel limits are reached (i.e., "01" or "32"), the next memory channel entered will be the opposite limit (i.e., "32" or "01").

Turning the TUNING CONTROL clockwise.

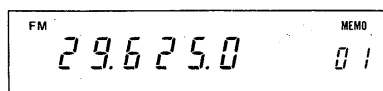
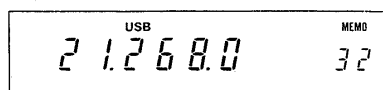
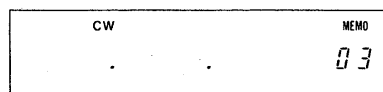
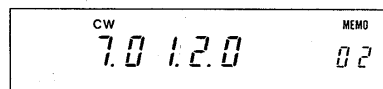
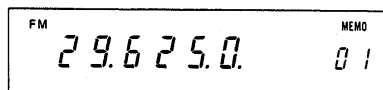

5-2-2 DIAL FUNCTION SELECT SWITCH (IN MEMORY CHANNEL MODE)

In the MEMORY CHANNEL MODE, by pushing the DFS (DIAL FUNCTION SELECT) switch in, the operating memory channel is locked on the displayed one and by turning the TUNING CONTROL, the OPERATING FREQUENCY displayed on the frequency display can be changed. This is very convenient for tuning a slightly off frequency or to change the operating frequency, or to rewrite the memorized frequency in the selected memory channel.

FOR EXAMPLE:

Now you are operating on 14.271MHz and USB with memory channel 7. If you want to change this frequency, push the DFS switch in, now you can change the displayed frequency. By turning the TUNING CONTROL clockwise increases the frequency and counterclockwise decreases one, the same as a VFO.

To tune to "14.295MHz", turn the TUNING CONTROL clockwise to obtain the desired frequency "14.295.0" on the display.

Pushing the DFS switch in, and turning the TUNING CONTROL.

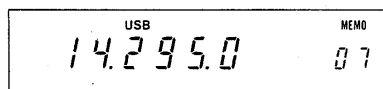
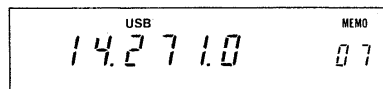

If you wish to transfer this operating frequency (14.295 MHz) and mode (USB) into a VFO, push the FREQUENCY TRANSFER button, and the operating frequency "14.295 MHz" and mode "USB" are transferred into the VFO previously selected.

NOTE: Don't push the VFO/MEMORY switch before pushing the FREQUENCY TRANSFER button to transfer the operating frequency (at this time, 14.295MHz), or the operating frequency is erased and the original memorized frequency (14.271 MHz) will be transferred into the VFO.

If you wish to rewrite the memorized frequency in the selected channel (at this time, "07") to this frequency ("14.295.0"), push the MEMORY WRITE button, and the operating frequency "14.295MHz" and mode "USB" are memorized into the memory channel 7.

To change the operating memory channel again, push and release the DFS switch, then turn the TUNING CONTROL.

5-2-3 MEMORY-WRITE (PROGRAMMING THE MEMORY CHANNELS)

Any operating frequency, mode and HAM/GENE mode can be memorized into a memory channel.

1. Set the operating frequency, mode and HAM/GENE mode to desired ones by a VFO. For example, set them for "15.725MHz", "AM" and "GENE" by using VFO B.
2. Push the DFS switch in, then select a memory channel to be memorized by turning the TUNING CONTROL. For example, select it at memory channel 10.
3. To check the contents in the memory channel, push the VFO/MEMORY switch, and the contents are displayed on the frequency display. If you don't like to rewrite these contents, select another memory channel which has contents erasable or no memorized frequency. (When no frequency has been memorized, only the MHz and KHz decimals are displayed at the frequency position.) After checking, push the VFO/MEMORY switch again to return to the VFO.
4. One push of the MEMORY WRITE button erases the previous memorized contents (if any) and memorizes the displayed frequency, mode and HAM/GENE mode into the selected memory channel (at this time channel 10).
5. Memorize other desired frequencies and so on into memory channels in the same manner. Memory channel 1 and 2 are used also for the PROGRAMMED SCAN. For PROGRAMMED SCAN operation, refer to "SCANNING OPERATION on page 20.

Frequency, mode and HAM/GENE mode to be memorized.

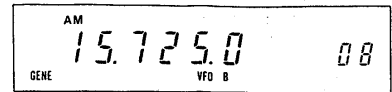

Pushing the DFS switch in, and turning the TUNING CONTROL.

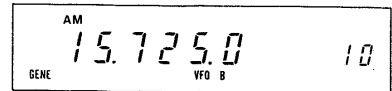
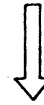

Pushing the VFO/MEMORY switch to check contents of the channel.

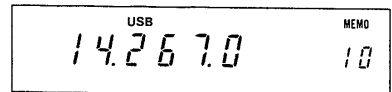

Pushing the VFO/MEMORY switch to return to the VFO, then pushing the MEMORY WRITE button.

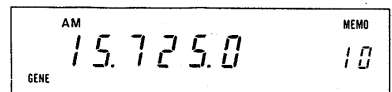
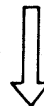

(This is displayed after pushing the VFO/MEMORY switch.)

5-2-4 MEMORY CLEARING

If you want to clear contents of a memory channel, the first, select the channel to be cleared, the second, push the FUNCTION KEY then the MEMORY WRITE or FREQUENCY TRANSFER button. The contents of the channel will be cleared.

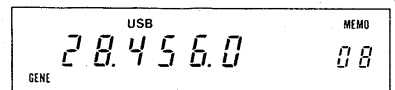

Pushing the FUNCTION KEY first, then the MEMORY WRITE or FREQUENCY TRANSFER button.

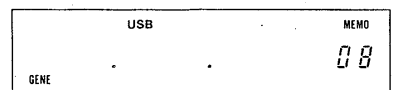
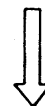

5-3 TUNING BY UP/DOWN BUTTONS ON THE MICROPHONE

5-3-1 FREQUENCY CONTROL

With each push of the UP or DN (down) button on the supplied microphone, the operating frequency is changed one increment up or down respectively. In the same way, by depressing the button continuously, the operating frequency is changed up or down the same as turning the TUNING CONTROL. The tuning rate is according to the setting of the TUNING RATE switch.

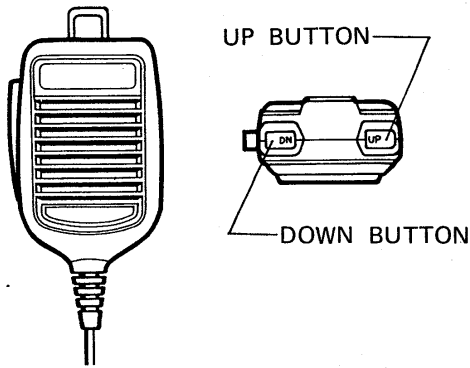

This function is effective in the VFO mode and when the DFS switch is pushed in to change the operating frequency in the MEMORY CHANNEL mode.

5-3-2 MEMORY CHANNEL SELECTING

In the MEMORY CHANNEL mode or when the DFS switch is pushed in to change the displayed memory channel number in the VFO mode, by depressing the UP or DN (down) button on the microphone continuously, the operating MEMORY CHANNEL or displayed channel number is changed up or down respectively every two seconds.

5-4 SCANNING OPERATION

The IC-751 provides various scanning operations. Please read the following instructions carefully to fully enjoy the IC-751's many capabilities.

5-4-1 MEMORY SCAN

This is used to scan all programmed memory channels continuously.

1. Program your desired frequencies into memory channels.
2. Select a memory channel programmed with a frequency. (The scan cannot start from a blank channel.)
3. Depress the SCAN START/STOP button, and the frequency starts scanning the programmed frequencies in the memory channels from the highest channel to lowest. At this time, the scan skips blank channels, if any.
4. If the SQUELCH is engaged, the scan stops when the squelch is opened and receives a signal. This restarts after passing a specified time.

To stop scanning without opening the squelch, depress the SCAN START/STOP button. Depress it again to restart the scanning.

5-4-2 MODE SELECTIVE SCAN

In the memory scan mode, by pushing the MODE SELECTIVE SCAN switch in, the scan scans only on channels having the desired operating mode.

To be in this scan mode, first, select a channel that has your desired mode, second, push the MODE SELECTIVE switch in, then the SCAN START/STOP button.

When the set is scanning in the normal memory scan mode, push the MODE SELECTIVE switch in at the moment that your desired mode is displayed on the display.

5-4-3 PROGRAMMED SCAN

This is to scan between two desired frequencies, which are memorized in the memory channels "1" and "2".

CAUTION The programmed scan does not start when the contents of memory channels 1 and 2, and frequency display differ from which are described below.

1. The same operation mode (HAM BAND or GENERAL COVERAGE mode) should be stored into memory channels 1 and 2. To start the scan, the set should be in the same operation mode as the memory channels.
 2. Stored frequencies in memory channels 1 and 2 should be in the same band, if the HAM BAND mode is stored in both memory channels 1 and 2. To start the scan, the set should be in the HAM BAND mode and in the same band as the memory channels.
1. Memorize the frequencies of the high and low edges of the desired scanning range into the memory channels 1 and 2. Regardless of which channel the higher frequency is memorized in, the scan starts from the high edge of the range.
For example, 14.200MHz is in the memory channel 1 and 14.300MHz in the channel 2.
 2. Place the unit in the VFO MODE and select operation mode the same as the channels 1 and 2, and a VFO you desire. Pushing the SCAN START/STOP button starts the scan from the high edge (14.300MHz) to the low edge (14.200MHz). The scanning frequency increments depend on the TUNING RATE SELECT switch setting.
 3. When the scanning frequency reaches the low edge (14.200MHz), it automatically returns to the high edge (14.300MHz) and continues scanning down to provide endless scanning operation.
 4. While the SQUELCH is engaged, the squelch opens when a signal is received and will stop the scanning automatically on the frequency, and the signal can be monitored. After approximately 10 seconds, the scan restarts from the frequency the scan stopped at, continuing to the low edge.
If the RECEIVE indicator is lit because the SQUELCH is not engaged, the scan does not stop at any signals.
 5. Depressing the SCAN START/STOP button while the scan is operating or during the 10 seconds of monitoring, clears the scanning operation and the VFO goes back to normal operation.

6. By turning the set into the transmit mode, or rotating the TUNING CONTROL, or pushing the VFO switch, RIT or XIT switch, VFO/MEMORY switch, or one of the MODE SELECT switches the scan stops and clears.

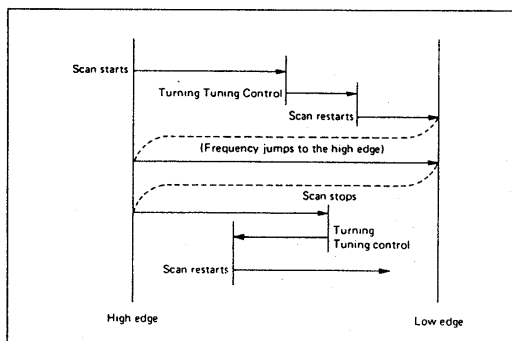

7. When the operating frequency is higher than the high edge (14.300MHz) and the SCAN START/STOP button is pushed, the scan starts from the operating frequency and scan down to the low edge, but it will return to the memorized high edge frequency (14.300MHz) and continue the scanning to the low edge. If the operating frequency is below the low edge frequency (14.200MHz), the scan frequency jumps to the high edge frequency (14.300MHz) and starts from the high edge.

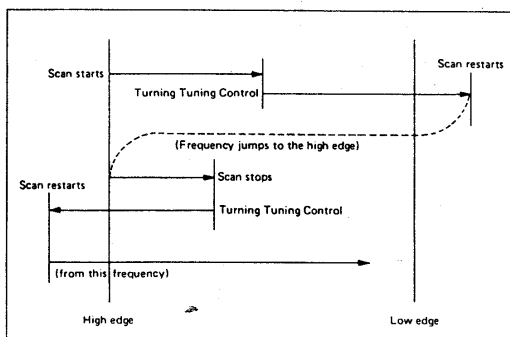

NOTE: The auto-stop functions with SSB or CW signals, but the scan does not always stop at the exact carrier frequency. When the scan stops on a signal, tune into the signal for better reception by pushing a MODE switch for the proper mode (if different) and by rotating the TUNING CONTROL.

5 - 4 - 4 RESUMING SCAN

All scan modes are provided with the resume scan function. When the scan has been stopped by the auto-stop function, the scan will restart after passing a specified time (about 10 seconds).

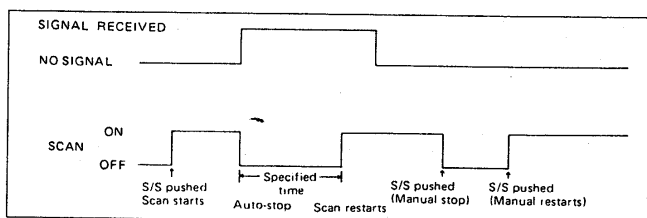

5 - 5 SSB OPERATION

5 - 5 - 1 RECEIVING

After connecting an antenna, microphone, etc., set knobs and switches as follows.

| | |
|-----------------------------|--------------------------------------------|
| POWER SWITCH | OFF (OUT) |
| T/R SWITCH | RECEIVE (DOWN) |
| VOX GAIN CONTROL | Completely Counterclockwise (OFF position) |
| NB LEVEL CONTROL | Completely Counterclockwise (OFF position) |
| AGC SWITCH | SLOW |
| AF GAIN CONTROL | Completely Counterclockwise |
| RF GAIN CONTROL | Completely Clockwise |
| SQUELCH CONTROL | Completely Counterclockwise |
| TONE CONTROL | Center (12 o'clock) Position |
| TUNING RATE SWITCH | OFF (OUT) |
| DFS SWITCH | OFF (OUT) |
| BAND SELECT FUNCTION SWITCH | OFF (OUT) |
| DIAL LOCK SWITCH | OFF (OUT) |
| FILTER SWITCH | OFF (OUT) |
| PBT CONTROL | Center (12 o'clock) Position |
| NOTCH FILTER SWITCH | OFF (OUT) |
| NOTCH FILTER CONTROL | Center (12 o'clock) Position |
| DUPLEX (SPLIT) SWITCH | OFF (OUT) |
| PREAMP/ATT SWITCH | OFF |

Now push the POWER switch in. The meter lamp will be illuminated, after a few seconds, a frequency, mode and HAM/GENE mode memorized in the VFO A, and memory channel number "01" will be shown on the frequency display.

In SSB operation there is both a USB (upper side band) and an LSB (lower side band). In the HAM bands, LSB is usually used on the 1.8, 3.5 and 7MHz bands, while USB is usually used on the 10MHz band and above. The IC-751 selects the normally used sideband according to the band in which you are operating.

If you wish to operate with the opposite sideband, first push the FUNCTION KEY then the SSB switch and the opposite sideband will be selected.

When you wish to operate on another band than the displayed one (If the desired band is not a HAM band, push the HAM/GENERAL switch so that the letters "GENE" are displayed.), push the BAND SELECT FUNCTION switch in, then turn the TUNING CONTROL so that the desired band is displayed.

Slowly turn the AF GAIN control clockwise to a comfortable level. Rotate the tuning knob until a signal is received. The meter needle will move according to the signal strength, so tune for the highest possible meter reading and the clearest audio. If you cannot get a clear signal, you may be receiving in the opposite sideband. If so, change the mode to the proper sideband.

Adjust the RF GAIN control and TONE control for comfortable reception.

If squelch operation is required to cut out noise when no signal is received, turn the SQUELCH control clockwise until the noise from the speaker stops and leave it just below this threshold.

For tuning, memory channel operation and scanning operation, please refer to 5 - 1 HOW TO TUNE on page 12, 5 - 2 MEMORY CHANNEL OPERATION on page 17 and 5 - 4 SCANNING OPERATION on page 20.

5 - 5 - 2 NB (NOISE BLANKER)

When there is pulse type noise, such as ignition noise from automobile motors, turn the NB LEVEL control clockwise further click ON, so that noise will be suppressed and even weak signals will be received comfortably.

When the NB switch is set in the WIDE (locked in) position, the noise blanker will effectively work for "woodpecker's noise", however, if the receiving signal is too strong, the noise blanker may work with the receiving signal itself, and some distortion may cause in the receiving audio or keying form. At this time, set the N.B. Switch in the out position, or turn the NB LEVEL control completely counterclockwise (OFF position).

5 - 5 - 3 AGC (AUTOMATIC GAIN CONTROL)

The IC-751 has a fast attack/slow release AGC system which holds the peak voltage of rectified IF signals from the IF amp circuit for a certain period. Therefore, during the pauses in normal speech of the received signal, uncomfortable noise will not be heard. The meter indicates the peak value for a certain period, facilitating reading of the meter "S" function.

For normal SSB reception, turn the AGC control clockwise to the SLOW position. Turn the AGC control counterclockwise to the FAST position, when tuning or receiving signals with short interval fading. When in the FAST position, the time constant is shortened.

When this control is set at the OFF position, the AGC circuit is turned OFF, and the S-meter does not work even if a signal is received. However the RF GAIN control is still active and the needle of the meter moves depending on the control position.

5 - 5 - 4 PREAMP/ATT SWITCH

Place the PREAMP/ATT Switch on the TOP to the PRE position when receiving weak signals. In the PRE position, an RF preamplifier is inserted into the receiving antenna circuit, increasing sensitivity and giving easy reception.

Place the PREAMP/ATT switch to the ATT position when strong nearby signals disturb signal reception or make "S" reading difficult. In the ATT position, the RF amplifier is removed from the circuit and a 20dB attenuator is inserted

into the receiving antenna circuit, reducing interfering signals and giving more stable reception. In normal operation the PREAMP/ATT switch is left in the OFF position.

5 - 5 - 5 P.B. (PASS-BAND) TUNING

Pass-Band Tuning is a system to narrow the bandwidth (selectivity) of the frequencies that will pass through the crystal filter electronically from either the upper or lower side continuously by up to 800Hz. This is very effective in reducing interference from nearby signals.

The PBT control has a click-stop at the center (12 o'clock) position. This is the widest pass band position and use the set at this position usually.

While receiving in the LSB mode, if you get interference from a lower frequency (interfering signals are high-pitched tones), narrow the band width by turning the P.B. tuning control counterclockwise. When the interfering signals are low-pitched tones, they are from a higher frequency, and you should narrow the bandwidth by turning the P.B. tuning control clockwise.

When receiving in the USB mode, the bandwidth is narrowed in the opposite manner. Interference from a higher frequency will be high-pitched tones, and the P.B. tuning control should be turned clockwise. Interference from a lower frequency will be low-pitched tones and the P.B. tuning control is turned counterclockwise.

This control can also be used for audio tone adjustment, so it may be set for the most comfortable reception.

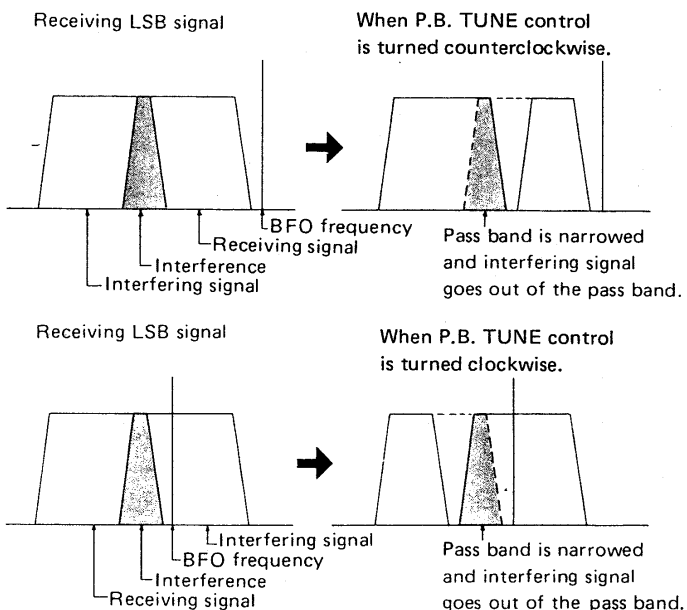

5 - 5 - 6 FILTER SWITCH

This switch selects the combination of the internal filters. When an optional filter is installed, this function will be more effective. Select and install the optional filter(s) to suit your favorite mode(s). Refer to 6 - 1 OPTIONAL FILTERS on page 28.

5-5-7 NOTCH FILTER

This circuit notches a frequency in the IF pass-band, so this is effective to reduce interference such as a beat-tone signal.

To use this function, push the NOTCH FILTER switch ON and turn the NOTCH FILTER control so that the interference is reduced.

5-5-8 TRANSMITTING

Before transmitting, listen in the receive mode to make sure your transmission will not interfere with other communications. If possible, use a dummy load for adjustment instead of an antenna. Set knobs and switches as follows.

MIC GAIN CENTER (12 o'clock) position
RF POWER CONTROL FULLY COUNTERCLOCKWISE
METER SWITCH ALC

Other knobs and switches are left in the same positions as for receiving. When the T/R switch is moved to transmit, or when the PTT (push to talk) switch on the microphone is depressed, the TRANSMIT Indicator is illuminated. By speaking into the microphone, the meter needle will move according to the strength of your voice and SSB signals will be transmitted. Set the MIC GAIN control so that the meter needle stays well within the ALC zone at voice peaks. If you wish to increase the output power, turn the RF POWER Control clockwise and adjust to obtain the desired RF output power of between 10 watts and 100 watts (approximately).

Change to the receive mode by moving the T/R switch to receive, or release the microphone PTT switch.

5-5-9 HOW TO USE THE SPEECH PROCESSOR

The IC-751 has a low distortion RF speech processor which enables greater talk power and better results in DX operation. Follow the steps below for use of the Speech Processor:

MIC GAIN CONTROL CENTER (12 o'clock) position
RF POWER CONTROL Fully Counterclockwise
COMP SWITCH ON
METER SWITCH COMP

Switch to transmit and turn the RF POWER CONTROL clockwise while speaking into the microphone until you obtain the desired RF "PEAK" output power of between 10 watts and 100 watts (approximately).

Adjust the MIC GAIN CONTROL to a point where the meter needle swings between 10dB and 20dB on the COMP scale.

The Speech Processor should be turned OFF or MIC GAIN CONTROL carefully set for minimum compression for all

communication other than DX operation for a very natural voice quality.

5-5-10 HOW TO USE THE VOX CIRCUIT

The IC-751 has a built-in VOX (voice operated relay) which allows automatic T/R switching by voice signals into the microphone. For VOX use, set the knobs and switch as follows:

VOX GAIN CONTROL
 FULLY COUNTERCLOCKWISE (OFF position)
VOX DELAY CONTROL
 FULLY CLOCKWISE
ANTI VOX CONTROL (on the top)
 FULLY COUNTERCLOCKWISE

Turn the VOX GAIN CONTROL on the front panel to click ON. Leaving the T/R switch in the RECEIVE position and without pushing the PTT switch, turn the VOX GAIN control further clockwise while speaking into the microphone. At a certain point, the T/R switching circuit will be activated by your voice. This is the proper position for the VOX GAIN control. Set the VOX GAIN control at a level which provides for T/R switching at your normal voice level. Transmit-release time (the delay before the set automatically returns to receive when you stop talking) is controlled by the VOX DELAY control. Turning the control counterclockwise makes the time shorter. Set it at a position which is comfortable and which allows for short pauses in normal speech.

Adjust the ANTI VOX control on the top so that the VOX circuit is not activated by sounds from the speaker by turning the control clockwise while receiving a signal.

5-5-11 MONITOR

The transmitting IF signals can be monitored in the SSB mode. So you can check the quality of the transmitting signals and conditions of the speech processor and so on.

To use this function, push the MONITOR switch in on the front panel and adjust the MONITOR LEVEL control on the top to a comfortable audio level. At this time, use headphones to prevent howling which will be caused by picking up sounds from the speaker.

5-6 CW OPERATION

5-6-1 RECEIVING

For CW reception, push the MODE SELECT Switch for CW mode, or CW-N mode (first the FUNCTION key, then the CW switch when an optional CW narrow filter is installed). Other switches and knobs are set the same as for SSB reception.

In addition to the crystal band pass filter, CW Narrow filters are optional for this unit. Refer to 6-1 OPTIONAL FILTERS on page 28.

Switch is set at the CW-N mode, this filter is activated and

the total selectivity of CW reception is improved (250Hz or 500Hz/−6dB). Also, with this filter, internal noise is reduced for comfortable CW reception and an improved signal to noise (S/N) ratio.

If the optional CW filter is not installed the set does not work in the CW-N mode.

The Pass Band Tuning system can be used to narrow the bandwidth up to 800Hz, the same as in the SSB mode.

Also, use the Noise Blanker, AGC switch and/or PREAMP/ATT switch depending on the receiving conditions, the same as SSB reception.

5-6-2 TRANSMITTING

Insert the keyer plug into the KEY Jack on the rear panel of the unit, and set knobs and switches as follows:

| | |
|------------------|--------------------------------------|
| RF POWER CONTROL | Fully counterclockwise |
| METER SWITCH | Po |
| VOX GAIN CONTROL | OFF (Completely Counterclockwise) |

Other knobs and switches are set the same as for CW reception.

By setting the T/R switch to TRANSMIT, the TRANSMIT indicator is lit and shows that you are ready for CW transmission. When you key the keyer, the meter needle moves and your CW signal is transmitted. To increase the transmitting power, turn the RF POWER Control clockwise to adjust while watching the meter needle on the Po scale for the desired output power.

5-6-3 CW SIDE-TONE (MONITOR)

When the MONITOR switch is pushed in, by keying the key, the side-tone oscillator is activated and an 800Hz tone will be heard. The loudness of the tone is controlled by the MONITOR LEVEL Control located on the top. Rotating the control clockwise will increase the loudness.

5-6-4 BREAK-IN OPERATION

The IC-751 has Break-In CW capability when using the VOX function. When keying, the unit is automatically set in the transmit mode. After keying, it is returned to the receive mode, also automatically, after a given transmit-release delay time constant. Leave the T/R switch in the RECEIVE position, and turn the VOX GAIN control clockwise to click ON.

The transmit release delay time constant is set by adjusting the VOX DELAY Control. Turning the VOX DELAY Control clockwise will make the transmit release time longer. Set it for your own keying speed.

By turning the VOX DELAY control fully counterclockwise and click OFF to the "FULL" position, the break-in

function reaches "FULL-BREAK-IN". So you can watch on the receiving frequency in the interval of each dot or dash.

5-7 RTTY OPERATION

For RTTY operation, a teletypewriter (or an equivalent) and a demodulator (terminal unit) which is operational with audio input are required. Any demodulator with 2125/2295Hz filters (narrow, 170Hz shift) can be used with the IC-751.

When a highspeed relay is used.

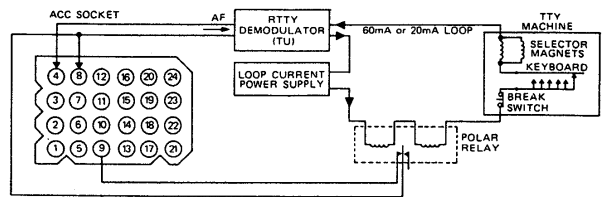

When a level converter is used.

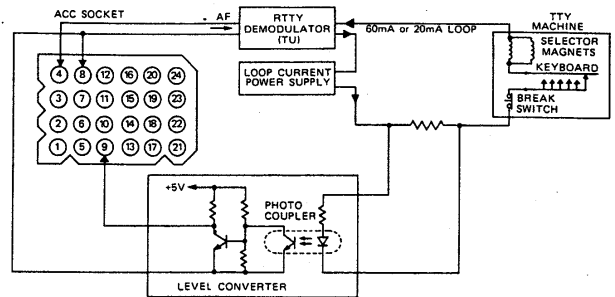

5-7-1 RECEIVING

Audio signals for the demodulator can be supplied from Pin 4 of the ACC socket on the rear panel, or from the PHONES jack on the front panel. The level of the audio signals from Pin 4 of the ACC socket does not vary by turning the AF GAIN Control, and the level is about 300mVp-p maximum.

Set the operating mode for RTTY, by pushing the MODE SELECT switch "RTTY". The other controls are the same as those for SSB reception. When tuning a RTTY signal, set the TUNING RATE SELECT switch OFF (out) position, and tune to get audio signals of 2125Hz for MARK and 2295Hz for SPACE. (Use the tuning indicator of the terminal unit for easy tuning.) Also adjust the P.B. Tune control for clear reception.

When an optional CW narrow filter is installed, by setting the set in the RTTY NARROW mode (By pushing the FUNCTION KEY first then the RTTY switch.), the narrow filter is activated and the total selectivity of the RTTY reception is improved (250Hz or 500Hz/−6dB) the same as the CW mode.

If you wish to receive RTTY signals which have wider shift such as 425Hz and 850Hz shifts, prepare a demodulator suits for the shift and use normal RTTY mode.

5 - 7 - 2 TRANSMITTING

For keying of the Frequency Shift Keying (FSK) circuit insert a high speed relay's coil into the loop current circuit of the teletypewriter, and connect the relay contacts to Pins, 8 and 9 of the ACC Socket on the rear panel. The relay contacts make during the Space and break during the Mark, as shown in the drawing. Fine adjustment of the MARK and SPACE frequencies can be done by adjusting the coil cores in the MAIN unit.

When a level converter for TTL level signals is used, connect the output of the converter to Pins 8 (ground) and 9 of the ACC Socket, apply High level (5V) signals for the Mark, and Low (0V) for the Space.

If your teletype machine puts out signals which are reverse polarity (LOW level; 0V, is for MARK and HIGH level; 5V, is for SPACE), slide S1 on the MAIN unit board to arrow direction as shown in the photo below.

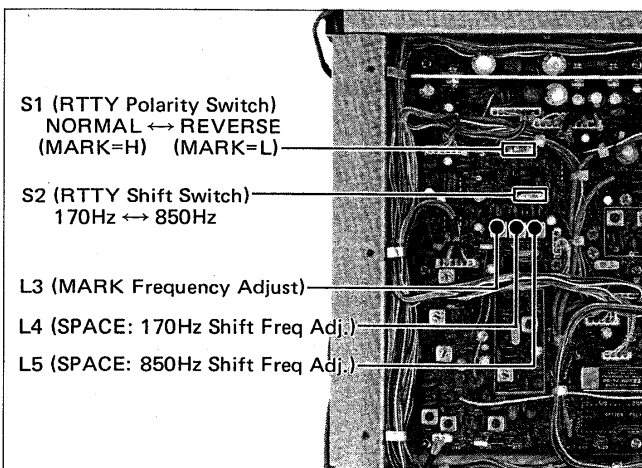

When using an AFSK generator that has 2125Hz for Mark and 2295MHz for Space, connect the output signals for the AFSK to the Mic connector on the front panel and set the Mode to LSB. (See Other Operations chapter.) Doing this, you can use the VOX operation available in this mode, and receive/transmit changeover is very easy.

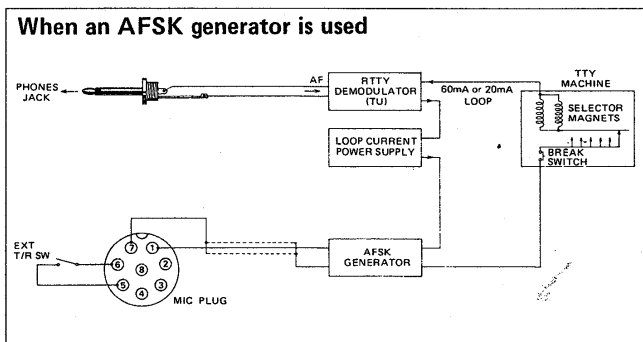

5 - 8 AM OPERATION

5 - 8 - 1 RECEIVING

Set the operating mode for AM, by pushing the MODE SELECT switch "AM". The other controls are the same as those for SSB reception, except the Pass Band Tuning. The

Pass Band Tuning control does not work in this mode. The optional crystal filter FL-33 will provide good selectivity for AM reception. Refer to the installation instructions 6 - 1 OPTION INSTALLATION on page 28.

When tuning an AM signal, tune for maximum signal strength as indicated on the meter.

5 - 8 - 2 TRANSMITTING

Transmitting AM signals is essentially the same as SSB transmission.

Set knobs and switches the same as for SSB operation. The RF output power can be adjusted between 10 Watts and 40 Watts by the RF POWER control. Also the speech processor can be used on this mode.

When transmitting the AM signals, the meter (in Po position) will indicate the carrier power, and the meter needle will move slightly according to your voice.

5 - 9 FM OPERATION

5 - 9 - 1 RECEIVING

Set the operating mode for FM, by pushing the FUNCTION KEY first, then the MODE SELECT switch "AM". The other controls are the same as those for SSB reception, however, the Pass Band Tuning control, Notch Filter, Noise Blanker, AGC circuits and FILTER SWITCH do not work in this mode.

When tuning an FM signal, tune for maximum signal strength as indicated on the meter and the clearest audio.

5 - 9 - 2 TRANSMITTING

Transmitting FM signals is essentially the same as SSB transmission.

Set knobs and switches the same as for SSB operation. However the speech processor can not be used on this mode.

When transmitting the FM signals, the meter (in Po position) will indicate the carrier power, but the meter needle does not move according to your voice such as SSB transmitting.

NOTE: Most countries may not allow to use the FM mode on HF HAM bands except 28MHz.

5 - 10 GENERAL COVERAGE RECEIVER

In this mode, the set does not transmit on any frequency, even if the frequency is on the HAM band.

Set knobs and switches as follows.

| | |
|------------------|--------------------------------------------|
| POWER SWITCH | OFF (OUT) |
| T/R SWITCH | RECEIVE (DOWN) |
| VOX GAIN CONTROL | Completely Counterclockwise (OFF position) |

| | |
|-----------------------------|-----------------------------------------------|
| NB LEVEL CONTROL | Completely Counterclockwise (OFF position) |
| AGC SWITCH | SLOW |
| AF GAIN CONTROL | Completely Counterclockwise |
| RF GAIN CONTROL | Completely Clockwise |
| SQUELCH CONTROL | Completely Counterclockwise |
| TONE CONTROL | Center (12 o'clock) Position |
| TUNING RATE SWITCH | OFF (OUT) |
| DFS SWITCH | OFF (OUT) |
| BAND SELECT FUNCTION SWITCH | OFF (OUT) |
| DIAL LOCK SWITCH | OFF (OUT) |
| FILTER SWITCH | OFF (OUT) |
| PBT CONTROL | Center (12 o'clock) Position |
| NOTCH FILTER SWITCH | OFF (OUT) |
| NOTCH FILTER CONTROL | Center (12 o'clock) Position |
| DUPLEX (SPLIT) SWITCH | OFF (OUT) |
| PREAMP/ATT SWITCH | OFF |

The other controls are unrelated and need not be set for this operation.

Now push the POWER switch in. The meter lamp will be illuminated and after a few seconds a frequency, mode and HAM/GENERAL mode memorized in the VFO A and memory channel number "01" will be shown on the frequency display.

If the operation mode is in the HAM band mode (The letters "GENE" are not displayed.), push the HAM/GENERAL COVER SELECT switch, and the letters "GENE" will be displayed on the frequency display and the set will work in the GENERAL COVERAGE mode.

In SSB operation there are both a USB (upper side band) and an LSB (lower side band). USB is selected on the 10MHz band and above, and LSB on the 9MHz band and below, by pushing the MODE SELECT switch SSB. When you wish to operate on the opposite sideband, push the FUNCTION KEY first, then the SSB switch.

However, the selected mode does not change on the entire band. For example, LSB has been selected on 8MHz band then the operating band is changed to 10MHz band or above, the operating mode, "LSB", will be kept.

When you wish to operate on a band other than the initialized band, push the BAND SELECT FUNCTION switch, then turn the TUNING CONTROL to select the band you wish to operate. Slowly turn the AF GAIN control clockwise to a comfortable level. After releasing the BAND SELECT FUNCTION switch, rotate the TUNING CONTROL until a signal is received.

The multi-function meter needle will move according to the signal strength, so tune for the highest possible meter reading and the clearest audio.

Refer to 5 - 5 - 2 ~ 7 on pages 22 and 23 for other functions, 5 - 6 - 1 on page 23 for CW reception, 5 - 7 - 1 on page 24 for RTTY reception, 5 - 8 - 1 on page 25 for AM reception and 5 - 9 - 1 on page 25 for FM reception.

5 - 11 OTHER OPERATIONS

5 - 11 - 1 VSWR READING

The IC-751 has a built-in VSWR meter for checking antenna matching in order to avoid problems caused by VSWR. Set the METER switch to the Po position. Set the operating mode to RTTY, and place the TRANSMIT/RECEIVE switch to TRANSMIT.

Adjust the RF POWER control located on the front panel so that the meter needle points to "SET" on the meter scale. Set the METER switch to the SWR position. With the switch in the SWR position, SWR reading can be seen on the meter. Although this unit is built to handle VSWR of up to 2:1, it is recommended that the antenna(s) be adjusted for the lowest possible VSWR. After taking the reading, return the METER switch to the Po position. **ALSO BE SURE THAT THE ANTENNA IMPEDANCE IS 50 OHMS OR THERE MAY NOT BE ANY OUTPUT. OTHERWISE THERE WILL BE DAMAGE TO THE TRANSCEIVER.**

The final transistors used in the IC-751 are of good design and are protected to a reasonable extent by circuits incorporated in the set. These devices can be expected to have an indefinite lifetime since there are no cathodes to burn out.

When in doubt about antenna systems, use the lowest power setting possible to achieve meaningful readings. Use a good tuner or transmatch when necessary. Always use caution and exercise judgement when testing RF power generators.

5 - 11 - 2 WWV RECEPTION

To receive WWV (or other standard frequency station), set the operating band to 10MHz in the HAM band mode or GENERAL COVERAGE mode, and the MODE to any mode. Tune to 10.000.0MHz on the frequency display.

Since the IC-751 has a General Coverage receiver built-in, any frequency's WWV can be received. Merely set to the GENERAL COVERAGE mode and tune to the desired frequency.

The WWV signal can be used for alignment of a frequency counter, marker oscillator, or the frequency display.

5 - 11 - 3 SIMPLE FREQUENCY ALIGNMENT

A very accurate frequency counter is necessary to align the frequency of the IC-751. However, the frequency can be aligned simply by receiving the WWV signal.

1. Set the frequency display to 10.000.0MHz (or other standard frequency you can receive clearly) in the GENERAL COVERAGE mode and the operating mode to AM, then make sure that you are receiving the WWV signal.
2. Turn ON the MARKER switch on the top.
3. Since a beat tone will be heard, adjust the MARKER CALIBRATOR on the top so that the beat tone becomes zero beat (When the standard frequency signal is modulated with a single audio tone, it makes more easily.).
4. This calibrates the reference oscillator frequency, so it is not necessary to calibrate on any other frequency, even if the operating band is different.
5. Turn OFF the MARKER switch.

5-11-4 RECEIVE ANTENNA TERMINALS

The RECEIVE ANT IN jack is connected to the input terminal of the receiving section, and the RECEIVE ANT OUT jack is connected to the antenna connector through the internal T/R antenna switching circuit.

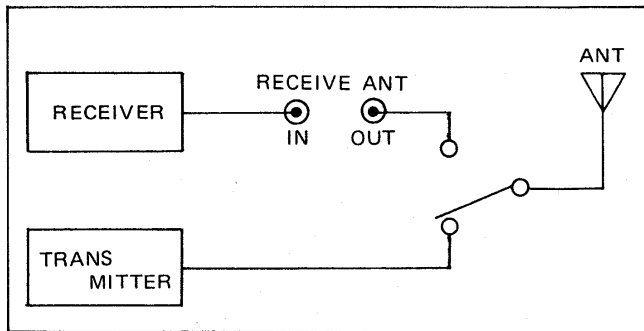

These two jacks are normally jumpered with a cable, but can be used for:

1. A receiving preamplifier.
2. A separate receiver.
3. Separate receiver and transmitter antennas.

If you wish to use a receiver preamplifier, connect it between the receiver input and antenna output terminals.

If a separate receiver is used, connect it to the receiver antenna output terminal. For a separate receive antenna connect it to the receiver input terminal.

5-11-5 TRANSVERTER CONNECTION

When a transverter control signal (+8V) is applied to Pin 11 of the ACCESSORY socket, the TRANSVERTER terminal can be used for a VHF/UHF transverter INPUT/OUTPUT terminal.

The transverter's input/output frequency and signal level should be as follows:

- Transverter INPUT/OUTPUT Frequency
28 ~ 30MHz
- Input/Output Level
Transmit (Output) : Max. 30mV across a 50 ohm load
Receive (Input) : 1μV for S/N 10dB

5-11-6 LINEAR AMPLIFIER CONNECTION

The jacks on the rear panel marked "RELAY" and "ALC" are a relay built-in for keying a linear amplifier and the input for ALC from the linear amplifier. For linear amplifier hookup the RELAY jack is for an internal relay and the ALC jack is for ALC input. The capacity of the relay is DC 24V 1A. Do not exceed this limit.

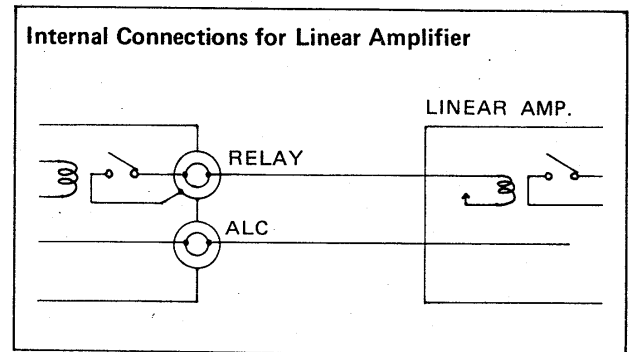

The optional linear amplifier IC-2KL and automatic antenna tuner IC-AT100/AT500 can be connected to the IC-751 with their accessory cables as same as other ICOM HF transceivers. Refer to their instruction manuals for detail.

The IC-751 puts out the band control voltage to change operating band automatically for external equipment such as a linear amplifier and antenna tuner. The voltage is put out from Pin 13 of the accessory socket. (Refer to page 5.)

Band Control Voltage Chart

| BAND (MHz) | Band Control Voltage |
|------------|----------------------|
| 1.8 | 7.0 ~ 8.0V |
| 3.5 | 6.0 ~ 6.5V |
| 7 | 5.0 ~ 5.5V |
| 14 | 4.0 ~ 4.5V |
| 18 - 21 | 3.0 ~ 3.5V |
| 24 - 28 | 2.0 ~ 2.5V |
| 10 | 0 ~ 1.2V |

SECTION 6 OPTION INSTALLATION

The following tools are needed for the installation of the options:

| | |
|---------------------|----------------------|
| Philips Screwdriver | Diagonal cutters |
| Screwdriver | Soldering Iron (40W) |
| Solder | Soldering tool |
| De-soldering braid | |

Before performing any work on the set, make sure that the power cord is detached from the transceiver.

Remove the top and bottom covers by unscrewing the six screws each on the top and bottom, and the three screws on each side.

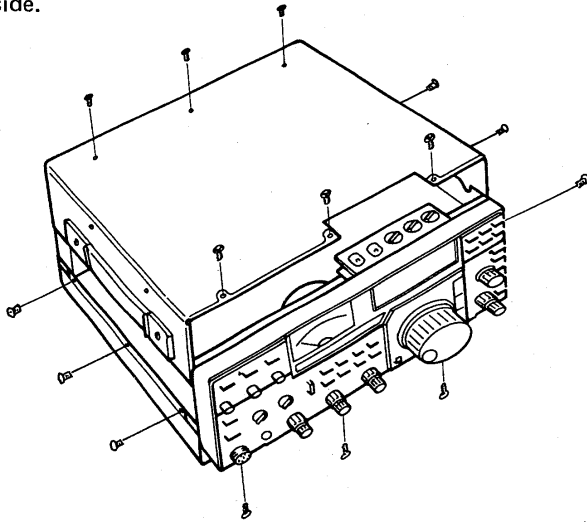

6 - 1 INSTALLATION OF OPTIONAL FILTER

6 - 1 - 1 OPTIONAL FILTERS PREPARED

We have prepared various optional filters as follows.

| | CENTER FREQUENCY | CHARACTERISTICS | USABLE MODE |
|--------|------------------|---------------------------|-------------|
| FL-32 | 9.0106MHz | 500Hz/-6dB, 1.6KHz/-60dB | CW•RTTY |
| FL-63 | 9.0106MHz | 250Hz/-6dB, 1.1KHz/-60dB | CW•RTTY |
| FL-33 | 9.0100MHz | 6KHz/-6dB, 20KHz/-60dB | AM |
| FL-70 | 9.0115MHz | 2.8KHz/-6dB, 5.0KHz/-60dB | SSB (Wide) |
| FL-52A | 455.0KHz | 500Hz/-6dB, 1.0KHz/-60dB | CW•RTTY |
| FL-53A | 455.0KHz | 250Hz/-6dB, 480Hz/-60dB | CW•RTTY |

The IC-751 has two positions for installing optional filters. The "B" position is for a 9MHz filter, one of the FL-32, FL33, FL-63 and FL-70, and the "D" position is for a 455KHz filter, one of the FL-52A and FL-53A.

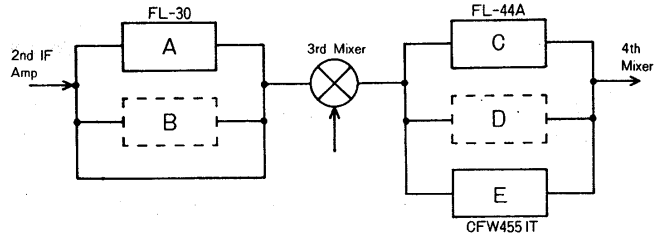
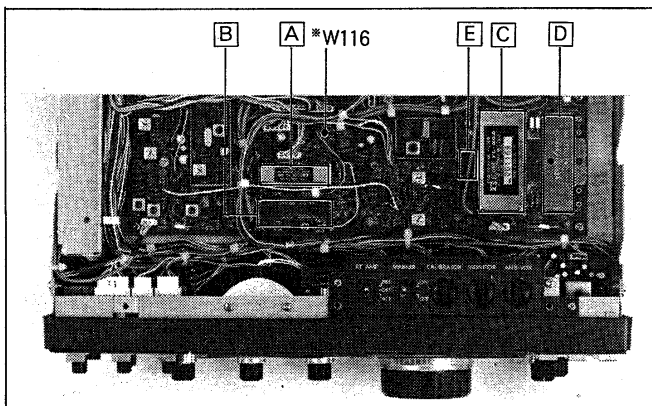

After optional filters are installed, the FILTER switch and PBT control function as follows:

1. When the FL-70 SSB wide filter is installed.

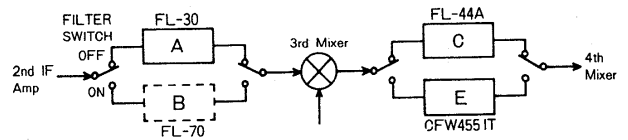

| FILTER SWITCH | BANDWIDTH | PBT CONTROL |
|---------------|-----------|-------------|
| OFF | NARROW | EFFECTIVE |
| ON | WIDE | NO WORK |

2. When CW narrow filter is installed.

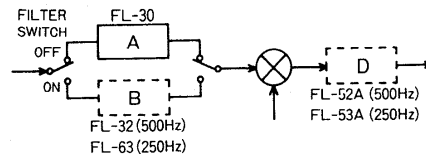

| FILTER SWITCH | BANDWIDTH | PBT CONTROL |
|---------------|-----------|-------------|
| OFF | WIDE | EFFECTIVE* |
| ON | NARROW | EFFECTIVE |

* The control works as IF SHIFT function and tone pitch can be adjusted.

3. When FL-33 AM filter is installed.

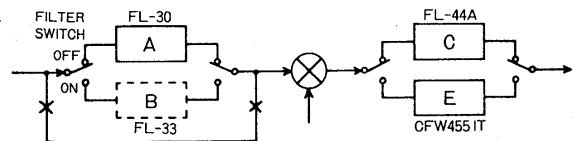

* When installing FL-33, cut the lead of W116 on the MAIN unit board. (Refer the photo.)

| FILTER SWITCH | BANDWIDTH | PBT CONTROL |
|---------------|-----------|-------------|
| OFF | NARROW | NO WORK |
| ON | WIDE | NO WORK |

Please choose an optional filter which is suitable to your needs.

6 - 1 - 2 ASSEMBLY PROCEDURE

When installing FL-52A or FL-53A, simply plug it into the specified position.

When installing a 9MHz filter;

1. Remove nine screws at each edge and the center of the MAIN unit board, and four screws at each corner of the FM unit board.

2. Tilt the units back toward left, being careful not to damage the sockets and plugs that are installed on the units.
3. The position for the filter is shown as "OPTION FILTER" on the MAIN unit board. The holes for mounting the legs and the leads of the filter are pre-drilled. Be sure to orient the filter so that the label on the top of the filter is facing the same direction as the other filter already mounted. Insert the filter flush with the board, bend the leads and legs flush with the opposite side of the board and solder them in. Trim the leads even with the solder points.
4. Change the connecting position of the jumper wire W113 as shown in the illustration. This completes the installation. Replace the units with the screws removed before, and top and bottom covers.

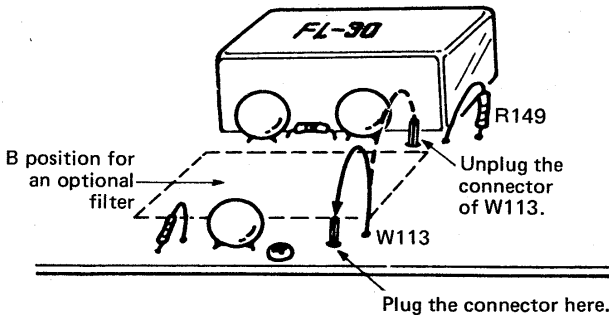

| | |
|---------------------|---|
| AC Power Cord | 1 |
| Spare Fuse | 2 |
| Installation Screws | 6 |
| Insulation Washers | 6 |

6-2-2 PREPARATION

Before performing any work on the set, make sure that the power cord is unplugged from the transceiver. Remove the top and bottom covers by unscrewing the six screws each on the top and bottom, and the three screws on each side.

6-2-3 ASSEMBLY PROCEDURE

- ① Turn the transceiver upside down. Remove the "PLATE (A)" attached to the rear panel by unscrewing four screws. These screws will be used later.
- ② Attach the main unit (power supply) to the bottom cover with supplied screws and insulation washers. At this time, insert the insulation spacer between the main unit and the bottom cover.

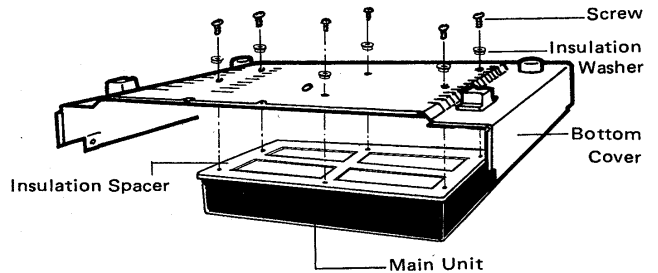

- ③ Pass the DC power cable attached to P1 through the hole of the AC power socket plate as shown in the illustration, then insert the bushing into the hole. Attach the AC power socket plate to the position which was attached the PLATE (A) before, by using the screws described in ①, so that the AC power socket is toward the bottom of the set.

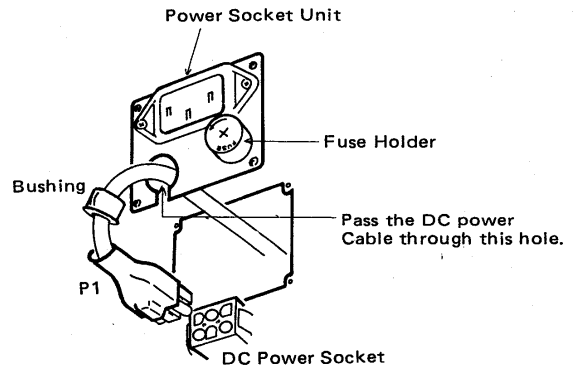

- ④ Pass the connector, P2', from the power socket unit to the inner chassis through the hole of the rear chassis. Then connect it with the connector, P2, from the main unit of the power supply.

6-2 BUILT-IN POWER SUPPLY UNIT IC-PS35

6-2-1 SPECIFICATIONS

Number of Semiconductors

| | |
|------------|---|
| Transistor | 5 |
| IC | 2 |
| Diode | 4 |

Input Voltage

110/220V AC (50/60Hz)

Allowable Voltage Fluctuation

±10% of input voltage
(suitable line voltage)

Input Capacity

550VA (at 20A load)

Output Voltage

13.8V DC Negative ground

Max. Load Current

20A (10 mins ON/10 mins OFF)

Dimensions

194(W) x 50(H) x 186(D) mm

Weight

Approx. 2.3kg

Kit Included

| | |
|-------------------|---|
| Main Unit | 1 |
| Insulation Spacer | 1 |
| Power Socket Unit | 1 |

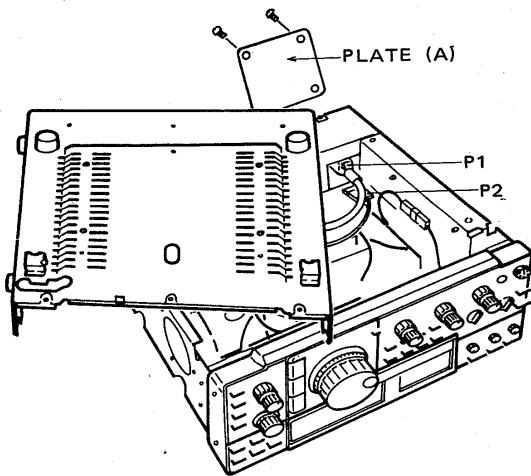

- ⑤ Put these AC wires into the rear chassis as long as possible as shown in the illustration. This will prevent to cause magnetic coupling between the AC wires and the VCO coil cores.

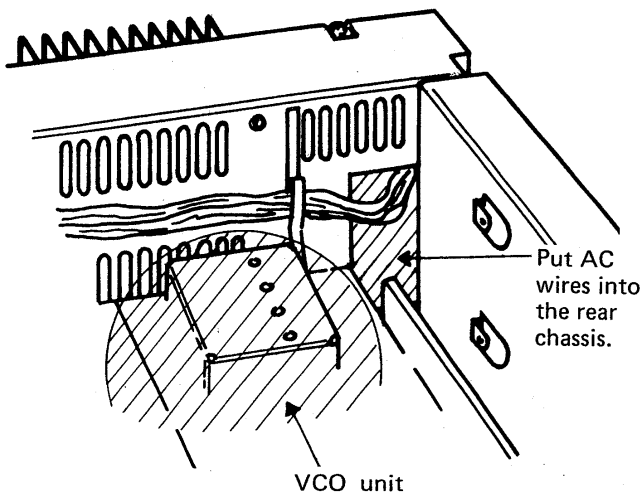

- ⑥ Replace the bottom and top covers of the set. Plug P1 of the power supply unit to the DC Power Socket of the set.

6-2-4 OPERATION

1. Connect the DC output plug, P1, of this unit into the transceiver DC power Socket securely. At this time, make sure that:
 - A. The power switch on the transceiver is OFF.
 - B. The T/R switch is in the RECEIVE position.
 - C. The PTT switch on the microphone is not depressed.
 - D. The VOX switch is in the OFF position.
2. Connect the supplied AC power cord into the AC power socket (newly installed) on the rear panel of the transceiver. Then connect the AC power plug into an AC power outlet.

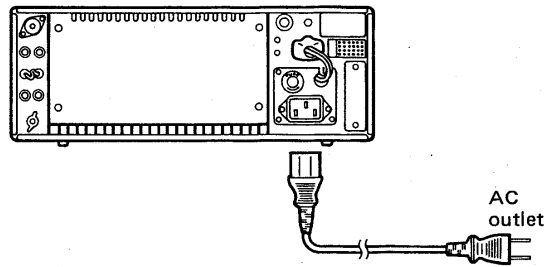

3. By turning the transceiver power switch ON, this unit will be turned ON and supply a DC 13.8V to the transceiver.

6-2-5 CAUTION

1. Ground the GROUND TERMINAL of the set with as short a wire as possible to prevent electrical shock, TVI, BCI and other problems.
2. This unit stops the output voltage with a protection circuit, when output voltage is shorted or consumed load current exceeds 25A. When the output voltage is stopped, turn the power switch of the transceiver OFF and remove the cause of the problem.
3. If the fuse blows, replace it with a 10A (at 117V) or 5A (at 240V) fuse after checking the cause of the problem. Use a Philips (+) screwdriver to open the holder. The outside ring of the holder cannot be rotated.

6-3 VOICE SYNTHESIZER UNIT IC-EX310

When this unit is installed, the set announces the displayed frequency by pushing the SPEECH switch on the front panel.

6-3-1 ASSEMBLY PROCEDURE

1. Turn the transceiver upside down.
2. Insert 2-P plug shown in the photo into J2 of this unit, then install the unit with the supplied four screws as shown in the photo.

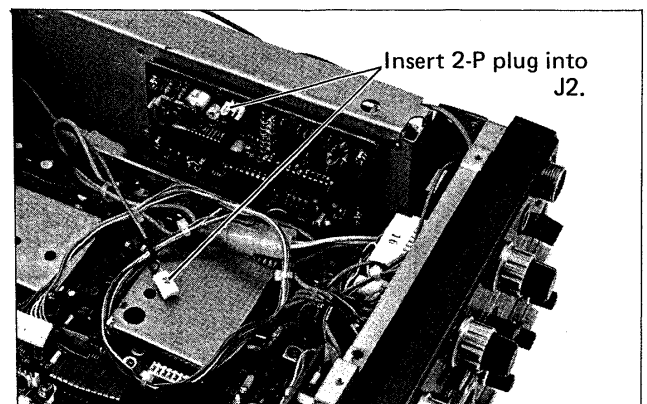

3. Plug 8-P plug of this unit into J12 of the LOGIC unit.

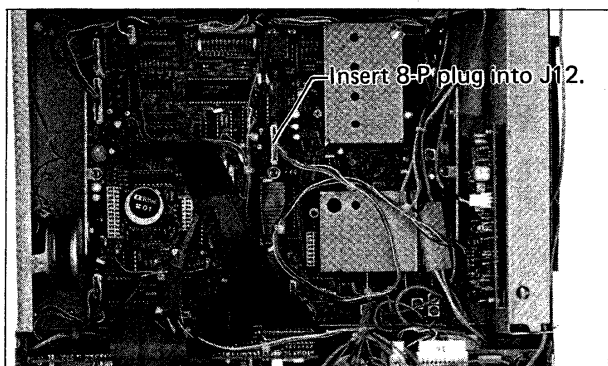

4. Adjust its volume and speaking speed if necessary. (Described later.)
5. Replace the top and bottom covers of the set.

6-3-2 ADJUSTMENT

1. Adjust the volume of the speech and speaking speed before the top and bottom covers are replaced, if necessary.
2. Connect a power source and turn on the power switch.
3. By pushing the SPEECH switch, the unit is actuated and announces the displayed frequency in English.
4. The volume of the announce is adjustable with R16 in the unit. Adjust it for comfortable level.
5. By cutting W1 jumper wire, the speaking speed becomes faster.
6. When finished the adjustment, replace the top and bottom covers of the set.

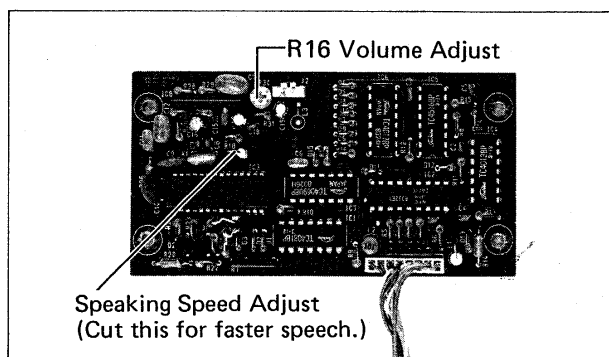

6-3-3 HOW THE VOICE SYNTHESIZER UNIT WORKS

1. When "14.231.5MHz" is displayed, by pushing the SPEECH switch. "ONE FOUR POINT TWO THREE ONE FIVE MHz", will be heard.
2. When a blanked memory channel is selected; "POINT MHz", will be heard.

6-4 HIGH-STABILITY CRYSTAL UNIT CR-64

6-4-1 FEATURES

This high-stability crystal unit is consisted of a temperature-compensating oven heater and a crystal unit. By replacing the original crystal unit with this unit, the total frequency stability of the set will be improved.

The specifications of the unit itself are as follows:

Oscillation frequency: 30.72MHz \pm 10ppm

Stability: \pm 0.5ppm in the range of $-30^{\circ}\text{C} \sim +60^{\circ}\text{C}$

6-4-2 ASSEMBLY PROCEDURE

1. Turn the transceiver upside down.
2. Unscrew the six screws retaining the PLL board and unplug the connectors and flat cables indicated in the photo, then turn the board over so that foil side can be seen.
3. Remove the solder of the original crystal unit terminal pins and grounding lead on the foil of the PLL board, by a de-soldering braid, then take off the crystal unit and grounding lead.
4. The location for the high-stability crystal unit is shown in the photo. The holes for the terminal leads of the unit are predrilled. If the holes are filled with solder, remove the solder with a de-soldering braid.

Be sure to orient the unit so that the crystal and heater terminal leads (indicated on the bottom of the unit) are the same direction as shown on the photo.

Insert the unit flush with the board, bend the leads flush with foil side of the board and solder them in.

5. Trim the leads even with the solder points.

6. Jumper the lands of the foil indicated in the photo by using supplied wire with insulating tube. At this time, take care to don't make short circuits with other lands of the foil.
7. This completes the installation. Replace the PLL board and plug the connectors and flat cables unplugged before. Then replace the top and bottom covers.

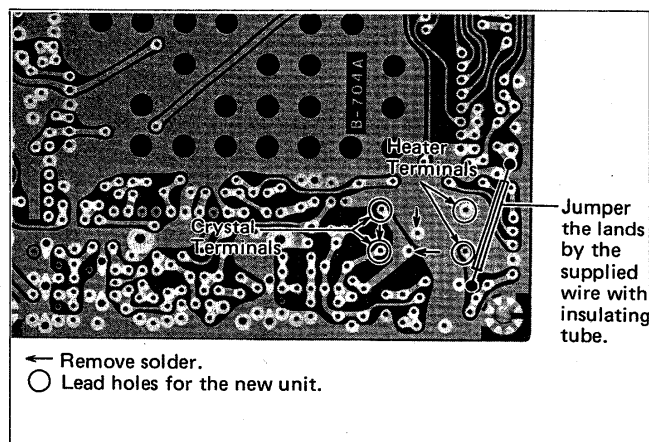
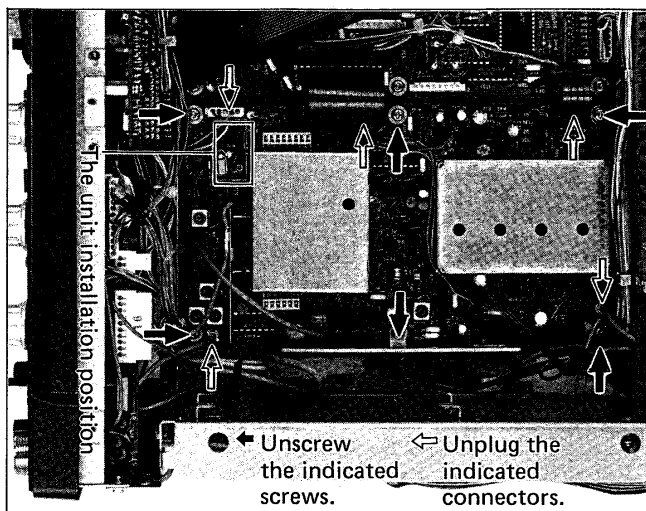

6-4-3 OPERATION

No adjustment is required and the unit improves the frequency stability of the set as follows:

Frequency Stability:

Less than $\pm 50\text{Hz}$ after switch on 1min to 60mins, and less than $\pm 10\text{Hz}$ after 1hour at normal room temperature. Less than $\pm 100\text{Hz}$ in the range of $-10^{\circ}\text{C} \sim +60^{\circ}\text{C}$.

6-5 OTHER OPTIONS

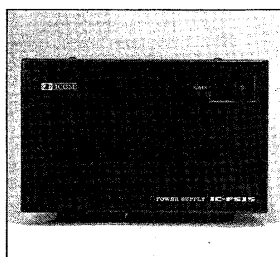

IC-PS15
AC POWER SUPPLY

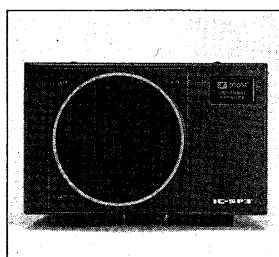

IC-SP3
EXTERNAL SPEAKER

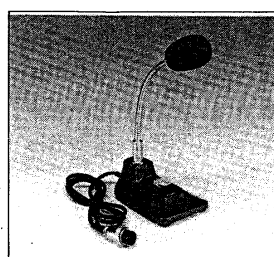

IC-SM6
ELECTRET CONDENSER TYPE
DESK MICROPHONE

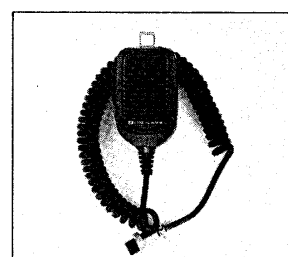

IC-HM12
SCANNING MICROPHONE



IC-HP1
HEADPHONES

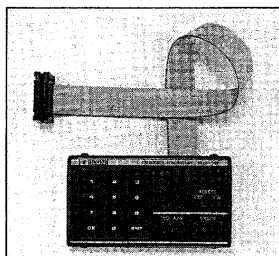

IC-10
FREQUENCY
CONTROLLER

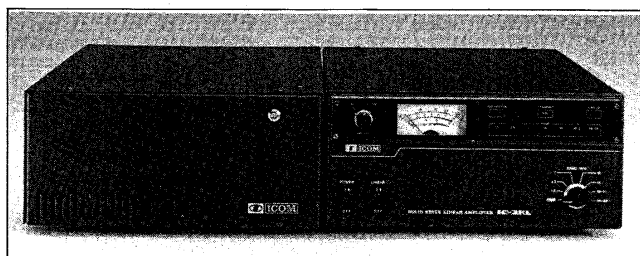

IC-2KLPS
ATTENDANT POWER SUPPLY
FOR IC-2KL

IC-2KL
500W SOLID-STATE
LINEAR AMPLIFIER

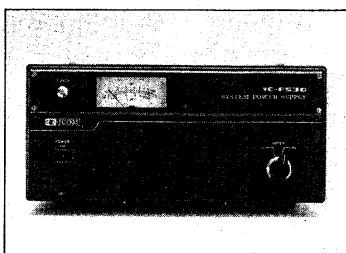

IC-PS30
AC SYSTEM POWER SUPPLY
13.8V 25A

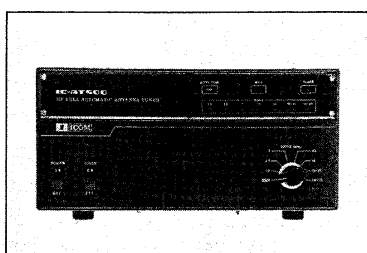

IC-AT100
(100W)
IC-AT500
(500W)
AUTOMATIC
ANTENNA TUNER

SECTION 7 INSIDE VIEWS

7-1 TOP VIEW

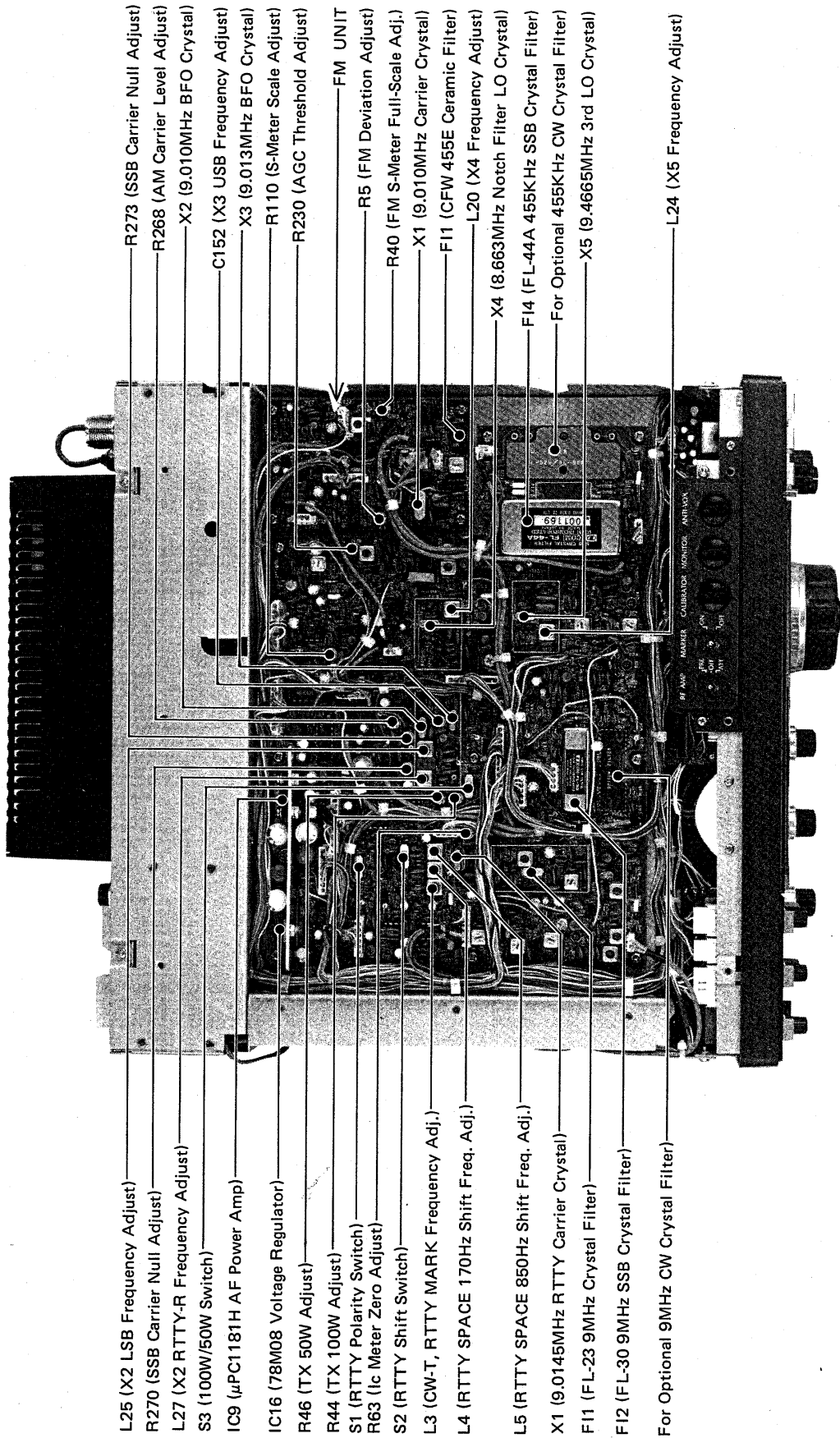

- L25 (X2 LSB Frequency Adjust)
- R270 (SSB Carrier Null Adjust)
- L27 (X2 RTTY-R Frequency Adjust)
- S3 (100W/50W Switch)
- IC9 (μ PC1181H AF Power Amp)
- IC16 (78M08 Voltage Regulator)
- R46 (TX 50W Adjust)
- R44 (TX 100W Adjust)
- S1 (RTTY Polarity Switch)
- R63 (Ic Meter Zero Adjust)
- S2 (RTTY Shift Switch)
- L3 (CW-T, RTTY MARK Frequency Adj.)
- L4 (RTTY SPACE 170Hz Shift Freq. Adj.)
- L5 (RTTY SPACE 850Hz Shift Freq. Adj.)
- X1 (9.0145MHz RTTY Carrier Crystal)
- F11 (FL-23 9MHz Crystal Filter)
- F12 (FL-30 9MHz SSB Crystal Filter)
- For Optional 9MHz CW Crystal Filter)
- R273 (SSB Carrier Null Adjust)
- R268 (AM Carrier Level Adjust)
- X2 (9.010MHz BFO Crystal)
- C152 (X3 USB Frequency Adjust)
- X3 (9.013MHz BFO Crystal)
- R110 (S-Meter Scale Adjust)
- R230 (AGC Threshold Adjust)
- FM UNIT
- R5 (FM Deviation Adjust)
- R40 (FM S-Meter Full-Scale Adj.)
- X1 (9.010MHz Carrier Crystal)
- F11 (CFW 455E Ceramic Filter)
- L20 (X4 Frequency Adjust)
- X4 (8.663MHz Notch Filter LO Crystal)
- F14 (FL-44A 455KHz SSB Crystal Filter)
- For Optional 455KHz CW Crystal Filter)
- X5 (9.4665MHz 3rd LO Crystal)
- L24 (X5 Frequency Adjust)

7 - 2 BOTTOM VIEW

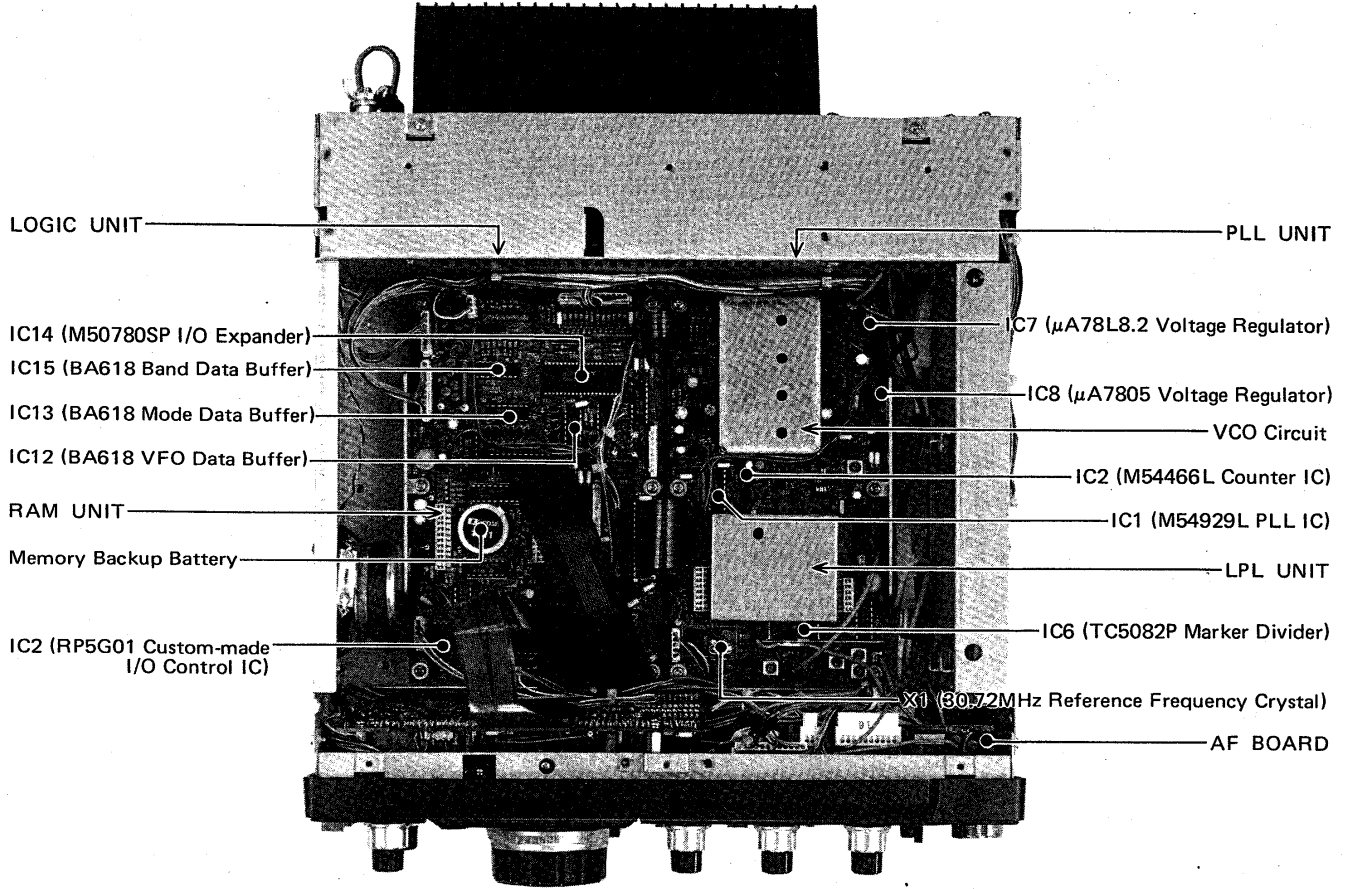

7 - 3 RF UNIT

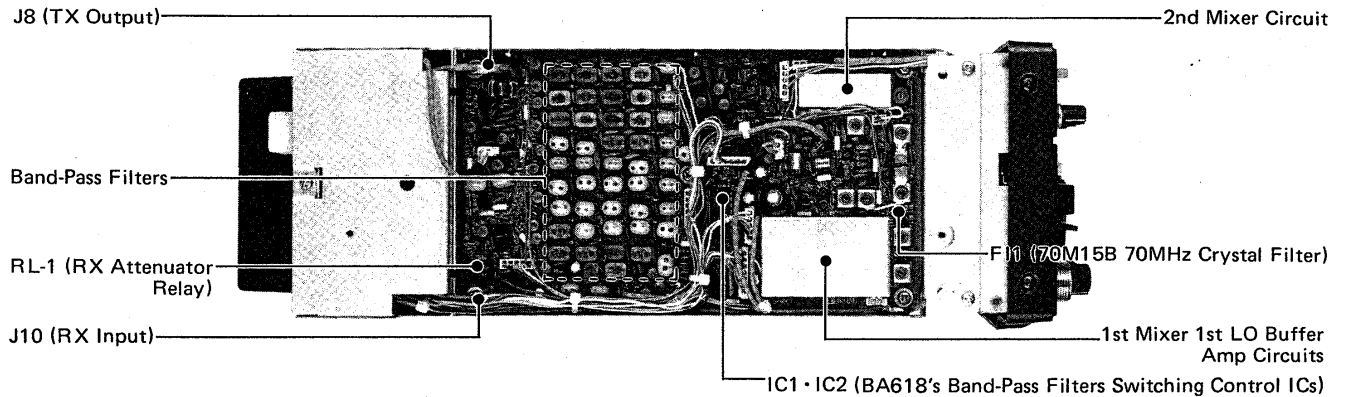

SECTION 8 TROUBLESHOOTING

Your IC-751 has been carefully adjusted at the factory prior to shipping. The chart below has been provided to help you correct problems which are not equipment malfunctions. If you are unable to locate the trouble, or correct the fault, please contact your dealer or the nearest ICOM Service Center.

| Problem | Possible Cause | Solution |
|-----------------------------------------------------------------------------------------------------------------------------------|------------------------------------------------------------------------------------------------------------------------------------------------------------------------------------------------------------------------------------------------------------------------------------------------------------------------------------------------------------------------------|-----------------------------------------------------------------------------------------------------------------------------------------------------------------------------------------------------------------------------------------------------------------------------------|
| 1. Power does not come on when the switch is pushed. | Power cable is improperly connected. Power cord is connected with the polarity reversed. Blown fuse. | Carefully reconnect power cable. Disconnect the power cord, replace the blown fuse, then reconnect the power cord observing proper polarity. Check for the cause, then replace the fuse with a spare one. If using an IC-PS15 or IC-PS30, also check its fuse. |
| 2. No sound comes from the speaker. | AF GAIN control knob is completely counterclockwise. The unit is in the transmit mode, either by the T/R switch or the PTT switch on the microphone. The external speaker cable is connected to the unit but not to the external speaker jack on the external speaker. The internal speaker cable is not connected. A headphone is connected to the PHONES jack. | Turn the knob clockwise to a suitable level. Put the unit in the receive mode. Connect the cable to the speaker jack on the external speaker. Connect the speaker connection. Unplug the headphone. |
| 3. Sensitivity is low and only strong signals are audible. | RF GAIN control knob is turned counterclockwise. The antenna feed line is cut or shorted. | Turn the RF Gain control knob fully clockwise. Check the feed line and correct any improper condition. |
| 4. During receive, the "S" meter is higher than the "0" position even when there is no signal. | RF GAIN control knob is turned counterclockwise. | Turn the knob fully clockwise. |
| 5. Only incomprehensible voices are heard during SSB reception. | Receiving the wrong sideband. | Set the sideband opposite the one you are using, either USB or LSB. |
| 6. The tone of the received signal is very high or low pitched. | Maladjustment of the P.B. Shift control. | Set the P.B. Shift control knob to the clear tone position. |
| 7. No output power or low output power. | MIC GAIN setting is too low. When SSB is desired, but the MODE is in the CW. PTT switch is not functioning due to improper connection of the mic connector. The antenna feed line is cut or shorted. | Turn the MIC GAIN control clockwise to the center (12 o'clock) position, or more. Set the MODE to the SSB (USB or LSB). Check the connection of the MIC connector and correct any problems. Check the antenna feed line and correct any improper connection. |
| 8. The receive mode functions properly and your signals are transmitted, but you are unable to make contact with another station. | The SPLIT switch is pushed in. The receive frequency is offset from the transmit frequency by the Incremental Tuning control. | Set the SPLIT switch to the out position. Turn OFF the RIT and/or XIT, or set the control knob to the center (12 o'clock) position. |
| 9. The heatsink on the rear panel becomes hot. | The heatsink on the rear panel is for the final transistors and may become as hot as 40°C (104°F) above room temperature. | Make sure the area around the unit has as much ventilation as possible. |
| 10. An unusual amount of distortion and/or noise in the transmit signal. | The MIC GAIN is too high when the Speech Processor is ON. | While watching the meter in the ALC mode, turn the MIC GAIN control counterclockwise so that the meter is within marked zone at the voice peak. |
| 11. Unable to key when using an electronic keyer or hand key. | The Switching circuit of the external electronic keyer does not close completely. Polarity of the connection wires from the keyer is reversed. The MODE is not in the CW. | Replace the keyer with one having a voltage of less than 0.4V between the two keying lines at the key down condition, or modify your keyer so that the voltage is less than 0.4 Volts. Connect the keyer wires observing proper polarity. Place the MODE in the CW. |
| 12. The frequency does not change by rotating the Tuning control. | DIAL LOCK is engaged. Improper setting of the DFS switch. | Disengage the DIAL LOCK by pressing and releasing the DIAL LOCK switch. Check the DFS switch whether pushed in or not and set it for proper operation. |
| 13. An abnormal out of band frequency is displayed on the frequency display. | The memory backup battery (graphite-lithium battery) on the RAM board is exhausted. | Contact with your dealer or ICOM service center. |

SECTION 9 BLOCK DIAGRAM

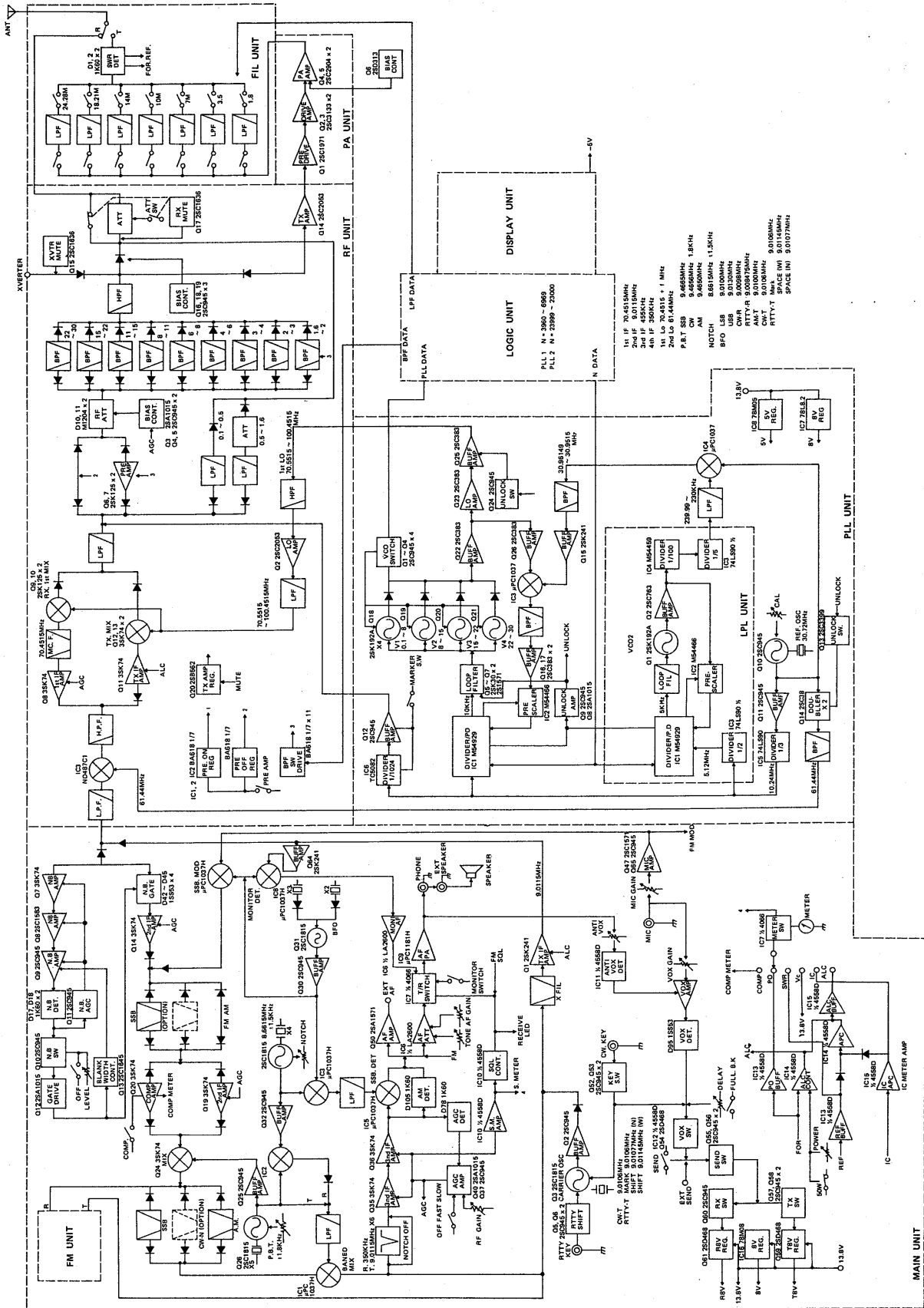

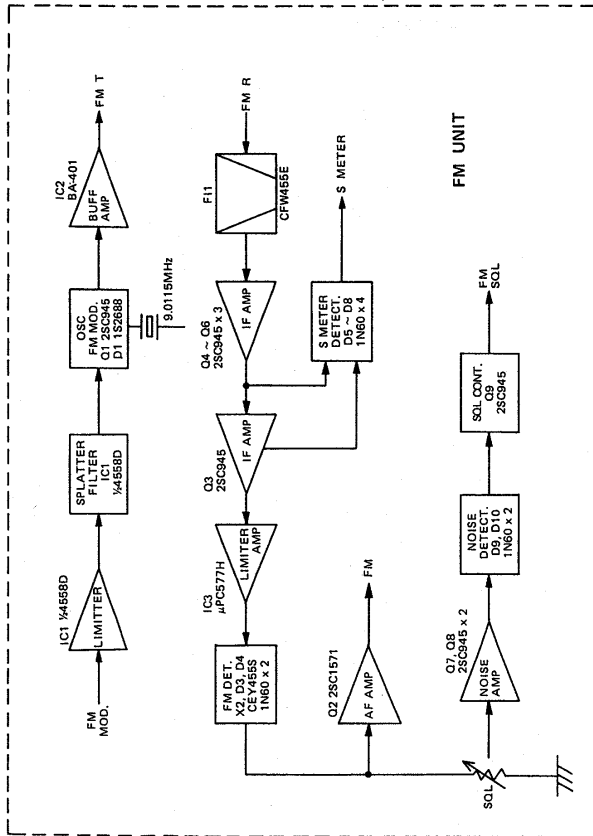
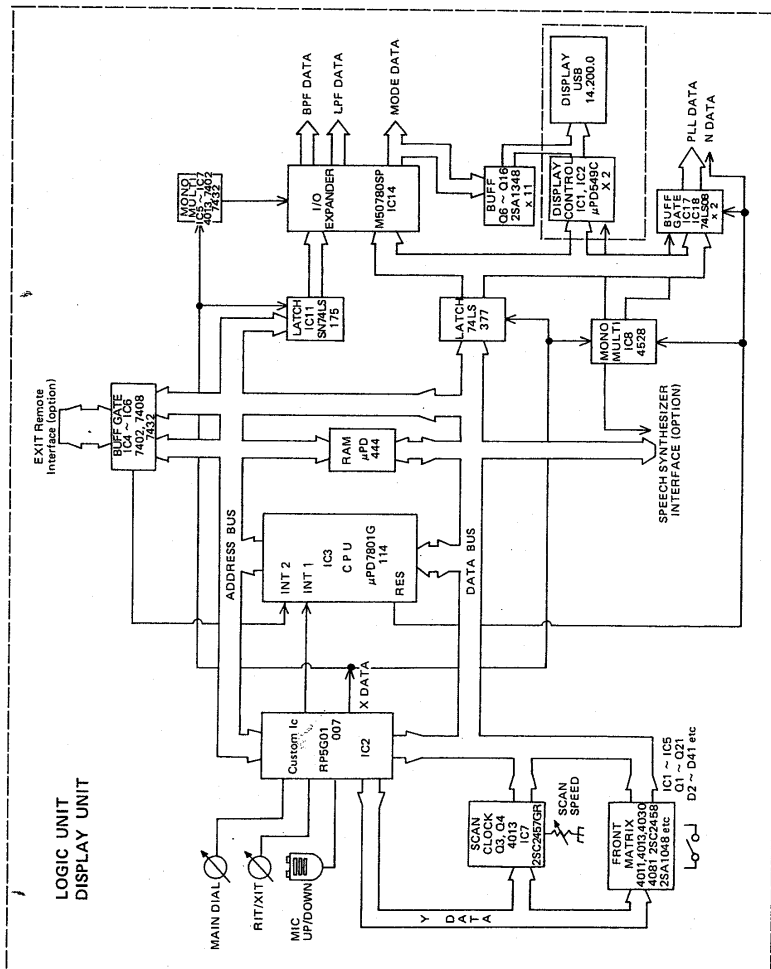



ICOM INCORPORATED
1-6-19, KAMI KURATSUKURI, HIRANO-KU,
OSAKA JAPAN

A-0493C
Printed in Japan