

GENERAL INFORMATION

The Alliance Tenna-Rotor® Model U-100 is a fully automatic unit. The control knob is turned to the desired direction and the rotor automatically rotates the antenna to that position and stops. The dial lights up when the direction is selected and turns off when the antenna reaches that position. The unit operates at a speed of 1 RPM and is equipped with a motor brake to prevent drifting or windmilling. The U-100 rotor can be identified by the blue weathershield and the model U-100 stamped into the metal housing. The U-100 control can be identified by the Model number U-100 stamped on the bottom of the control. **The U-100 Rotor and Control are not interchangeable with any of the former Alliance Models.**

PLEASE NOTE:

Although some U-100 parts are interchangeable with the parts used on the U-98, many of the important or critical parts are not. Check the U-100 parts list before replacing any parts. For example—the transformer, solenoid, capacitor, frame and dial assembly, and the motor are different and cannot be interchanged with parts used on any of our other models.

The outward appearance of the U-100 is identical with the U-98 so be sure to check model number on bottom of the control and model number stamped in rotor housing when ordering replacement units or parts. Note: **The U-100 Rotor can be used only with the U-100 control and Vice Versa.**

SERVICING PROCEDURE

Power-off Checks

1. Viewing from front, left pawl (Item No. 121) should clear slotted escapement disc by .010 inch to .035 inch with solenoid in energized position.
2. Right pawl (Item No. 121) should clear slotted escapement disc by .010 inch to .035 inch with solenoid in de-energized position.
3. Left pawl must come to rest in any given stop position. After stop position is reached, depress plunger in solenoid by hand to make sure pawl drops freely into slot. Adjustment is made by moving indent spring assembly (Item No. 133).
4. Contact spring (Item No. 27) in the rotor unit must make contact only when cam lobe (Item No. 41) comes in contact with the switch. If shaft assembly (Item 6) is removed from the rotor unit, cam lobes must be $\frac{1}{2}$ turn away from contact points in end-stop position in both directions. See Fig. 53.
5. Be sure that four-conductor cable is connected to proper terminals. Terminal No. 1 in the rotor connects to No. 1 on the control case and so on with Nos. 2, 3, and 4.
6. Check length and size of four conductor cable. See Figure 4.
7. Primary input contacts should be .020 inch apart. Adjustment can be made at factory only.
8. Red pointer on dial face should point to the direction which corresponds with the antenna at the stop position. This adjustment is made by removing the knob and inserting a narrow tool through the elongated radial slot to the gripping holes in the pointer and turning the pointer to the correct position.

Alliance U-100

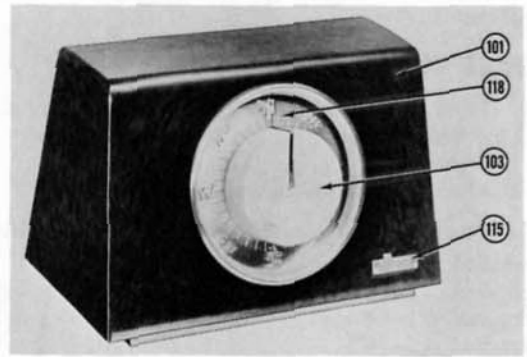

Fig. 49. Control Box—Model U-100.

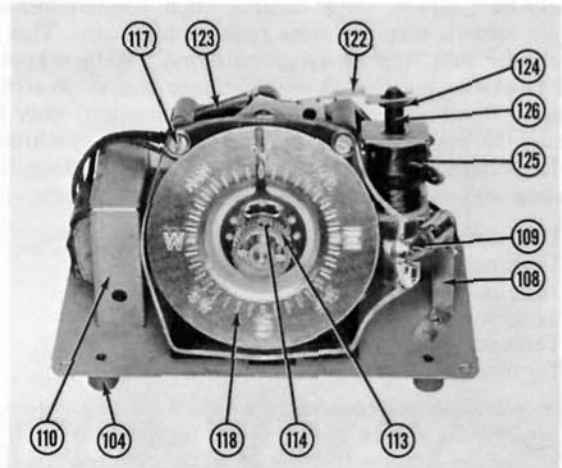

Fig. 50. Internal Components—Model U-100 Control Box.

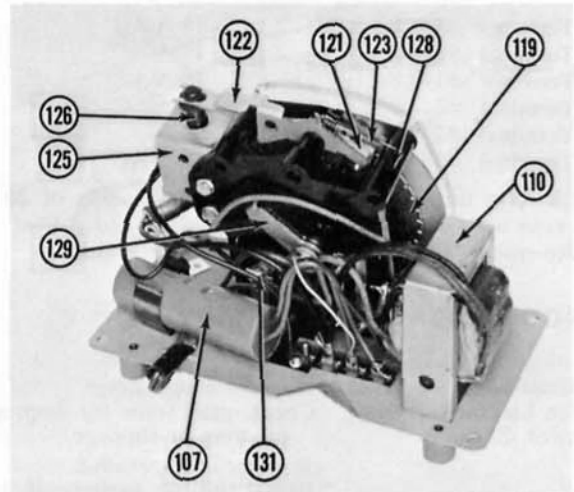

Fig. 51. Internal Components—Model U-100 Control Box.

Power-on Checks

1. Line voltage should be approximately 115 volts.
2. Turn knob (Item No. 103) to extreme counterclockwise stop. Solenoid must not buzz and mechanism must move correctly, no sticking or slipping. Rotator must turn to extreme counterclockwise stop and light must turn off when rotator reaches the top. If the light does not turn off, synchronize unit per instructions on bottom of control case.

VOLTAGE CHART

Conditions of measurement:

Line Voltage.....117 VAC

Tolerance.....± 10%

Measured values at control box terminals

1. Control Only—4 Conductor Cable disconnected

Terminal #1—#2.....	0 V
Terminal #1—#3.....	29 VAC
Terminal #1—#4.....	0 V
Terminal #2—#3.....	29 VAC
Terminal #2—#4.....	0 V
Terminal #3—#4.....	29 VAC

2. Locked Rotor—100 feet of #20 A.W.G. 4 conductor cable connected to control and rotor. With rotor at full **clockwise** position, turn control knob counterclockwise. While rotor is turning, press reset button twice. This will throw the unit "out of synchronization." Return knob to full clockwise position to make voltage checks. Warning: Control should be left "out of synchronization" only long enough to make the voltage checks, then re-synchronize. If left unsynchronized for a long period of time, overheating and damage to the transformer will result.

Terminal #1—#2.....	20 VAC
Terminal #1—#3.....	18 VAC
Terminal #1—#4.....	0 V
Terminal #2—#3.....	15 VAC
Terminal #2—#4.....	20 VAC
Terminal #3—#4.....	17 VAC

With rotor turning **counterclockwise**, a pulsing reading of 20 to 25 volts will be read between terminals #1 and #4.

3. Locked Rotor—100 feet of #20 A.W.G. 4 conductor cable connected to control and rotor. With rotor at extreme **counterclockwise** position, turn control knob clockwise. While rotor is turning, press reset button twice. This will throw the unit "out of synchronization." Return knob to extreme counterclockwise position to make voltage checks.

Terminal #1—#2.....	19 VAC
Terminal #1—#3.....	15 VAC
Terminal #1—#4.....	19 VAC
Terminal #2—#3.....	17 VAC
Terminal #2—#4.....	0 V
Terminal #3—#4.....	16 VAC

With rotor turning **clockwise**, a pulsing reading of 20 to 25 volts will be read between terminals #2 and #4.

Re-synchronize unit immediately after checking.

TROUBLE SHOOTING CHART

TROUBLE	CAUSE
Rotator fails to operate when knob is turned to desired direction.	<i>If motor is operating:</i> Check gear train for improper meshing or slippage. <i>If motor is inoperative:</i> Press tuning spring—if box mechanism operates properly, the trouble is not in the sole-

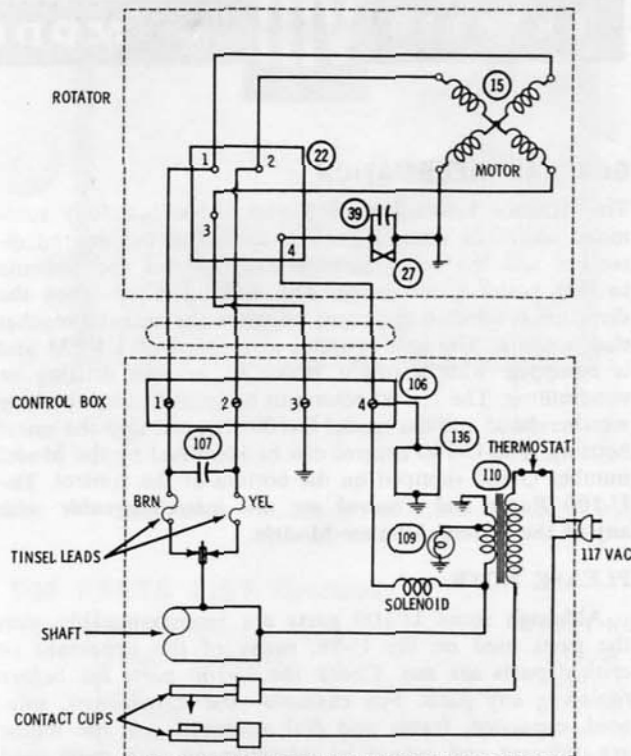

Fig. 52. Schematic Wiring Diagram—Model U-100.

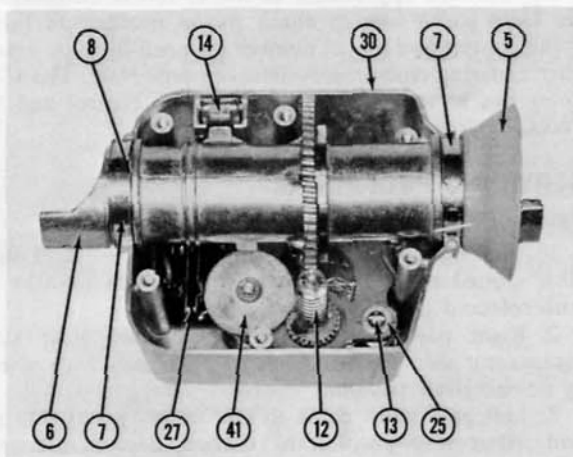

Fig. 53. Internal Components—Model U-100 Rotator Unit.

TROUBLE SHOOTING CHART Continued

TROUBLE	CAUSE
	noid, transformer, or the mechanical parts of the escapement assembly.
	Check input contacts to be sure they are closed.
	Check terminals 1-3, or 2-3, depending upon desired direction of rotation for approximately 18 to 20 volts.
	Check contact springs on the frame assembly for proper contact with rings.
	Check capacitor in control.
	Check contact switch in rotor for proper operation. Switch should close when cam lobe hits switch blade.
	Check motor for shorts or open connections.

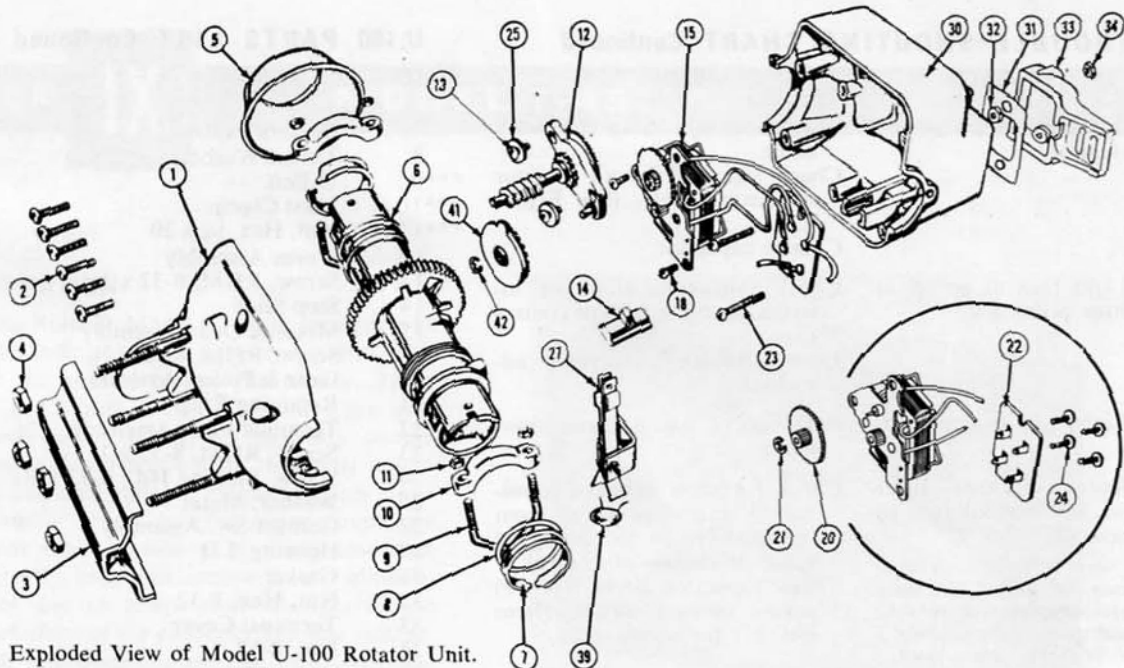

Fig. 55. Exploded View of Model U-100 Rotator Unit.

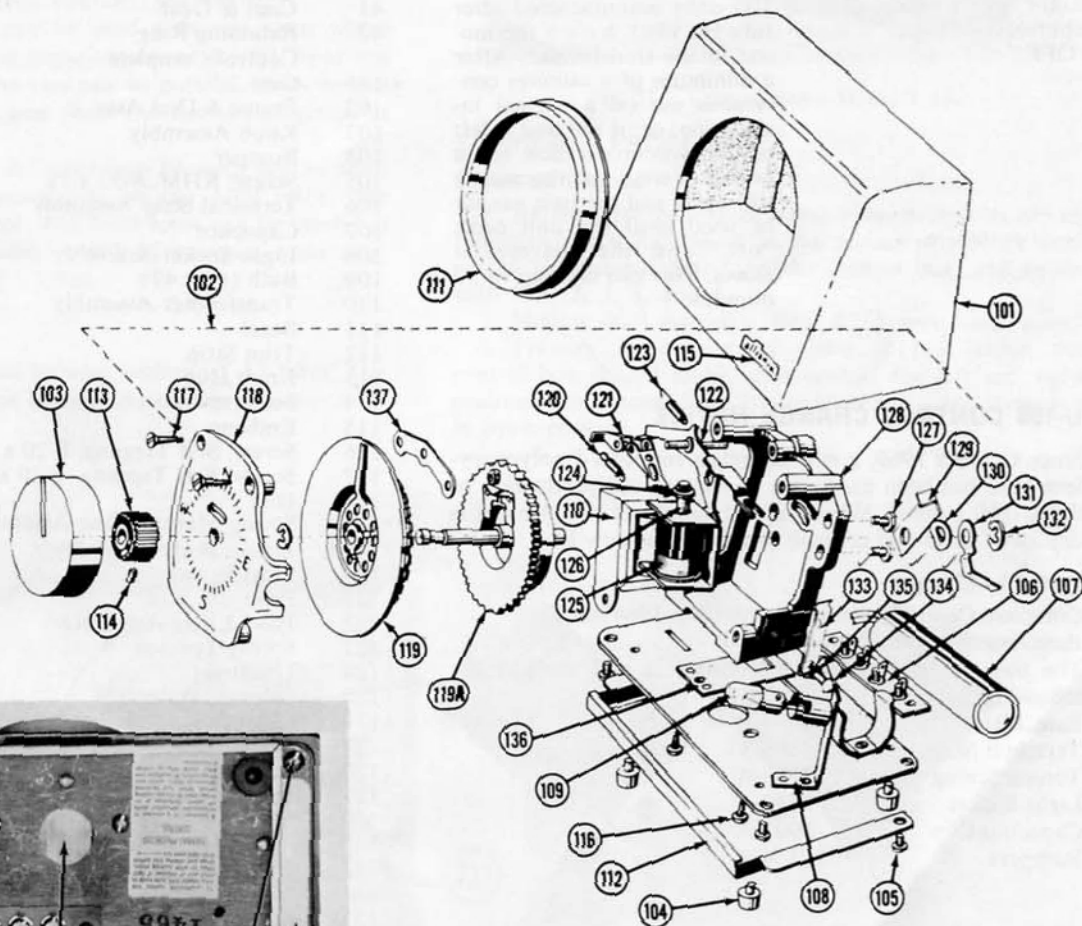

Fig. 56. Exploded View of Model U-100 Control Box.

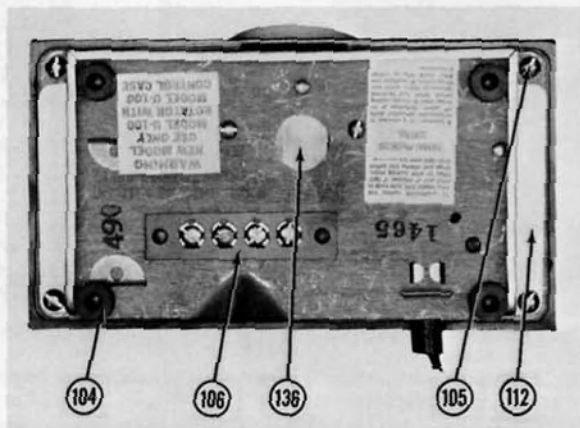

Fig. 54. Bottom View of Model U-100 Control Box Showing Terminal Strip.

TROUBLE SHOOTING CHART Continued

TROUBLE	CAUSE
Rotor operates slowly or sluggishly.	Check hook up of four conductor cable. <i>Check size and length of four conductor cable. (See Figure 4.)</i> Change capacitor.
Light fails to go off at stop position.	Check synchronization per instructions on bottom of control case. Input contacts improperly adjusted.
Light fails to come on.	<i>Bulb bad or socket connections loose.</i>
Rotor operates—light on, but control fails to operate. (Note: In some cases rotor may not operate with these symptoms because the voltage drops approximately 5 volts at the control box.)	Check for short between terminals 3 and 4 or short from terminal No. 4 to casting of rotor or chassis of control. <i>Check capacitor (Item No. 39) across contact switch (Item No. 27) for short.</i>
Rotor and Control inoperative—Light "OFF."	U-100 units manufactured after July 10, 1963, have a thermostat in the transformer. After a minimum of 4 minutes continuous use on a normal installation, or, if the unit is left out of synchronization for a period of time, the thermostat will open and the unit cannot be used until the unit cools "off" and the thermostat closes. This can take up to 30 minutes.

U-100 CONTROL CHANGE NOTICE

Since October 1969, a new fiberglass reinforced polypropylene base has been used on a portion of our production of the U-100 control. When present supply of metal bases is depleted, all U-100 controls will have the new base.

Parts List Changes

Complete Control Assembly—Part No. 18649-R	
Base Assembly—Part No. 18647-R	
The base assembly 18647-R consists of and replaces the following parts:	
Base Plate	8914-R
Terminal Strip	3803-S
Tuning Spring	5563-A
Light Socket	5558-A
Capacitor Clip	8903-A
Bumpers	18174-A

U-100 PARTS LIST

ITEM	NAME	PART NO.
	Rotor Complete	8910-R
1	Housing Assembly RH	5454-R
2	Housing Screws, 10-32 x 3/4	3429-N
3	Clamping Plate	5456-A
4	Nut, Hex, 1/4 x 20	8100-E
5	Weathershield	3375-F
6	Shaft Assembly	9373-R

U-100 PARTS LIST Continued

ITEM	NAME	PART NO.
7	Bearing Collar	3987-B
8	Thrust Washer	3376-B
***9	U-Bolt	18291-A
***10	Mast Clamp	18292-R
***11	Nut, Hex, 1/4 x 20	8100-E
12	Worm Assembly	18074-R
13	Screw, RHM, 8-32 x 3/8	3429-Q
14	Stop Slide	3320-A
15	Motor & Gear Assembly	18508-R
18	Screw, RHM, 8-32 x 3/8	3429-Q
20	Gear & Pinion Assembly	3373-R
21	Retaining Ring	4243-H
22	Terminal Plate Assembly	8919-R
23	Screw, RHM, 8-32 x 1	8013-A
24	Screw, Binding Hd., 6-32 x 3/16	608-H
25	Washer, Metal	2715-H
27	Contact Sw. Assembly	5908-R
30	Housing, LH	14246-A
31	Gasket	5449-A
32	Nut, Hex, 8-32	3426-A
33	Terminal Cover	9319-A
34	Nut, 8-32	3426-A
39	Capacitor	8533-B
41	Cam & Gear	4292-B
42	Retaining Ring	4243-K
	Control Complete	8913-R
* 101	Case	5559-A
102	Frame & Dial Assy.	8516-S
103	Knob Assembly	5556-R
104	Bumper	5628-A
105	Screw, RHM, 8-32 x 3/8	3429-Q
106	Terminal Strip Assembly	3803-S
107	Capacitor	18061-A
108	Light Socket Assembly	5558-R
109	Bulb (type 47)	4274-A
110	Transformer Assembly	9100-R
111	Bezel	8525-B
112	Trim Strip	8528-A
113	Knob Hub	5555-A
114	Set Screw	8066-A
115	Emblem	8530-A
116	Screw, Self Tapping, 6-20 x 1/2	603-N
117	Screw, Self Tapping, 6-20 x 3/8	603-K
118	Dial	8519-A
** 119	Spring Motor & Disc Assembly	18504-R
** 119A	Detent Body Assembly	18505
120	Pawl Spring	5667-A
121	Pawl	8518-A
122	Pawl Lifter Assembly	8512-R
123	Spring Tension	8520-A
124	Grommet	8509-A
125	Solenoid Assembly	8511-S
126	Pfunger	8504-A
127	Screw, Hex, 6-32 x 1/2	8027-D
128	Frame Assembly	5515-S
129	Stop Lever	18042-A
130	Spring Washer	5568-A
131	Terminal	5540-A
132	Retaining Ring	4243-B
133	Indent Spring	18093-A
134	Screw, RHM, 6-32 x 3/8	3429-P
135	Washer, 3/16	2715-P
136	Tuning Spring	5563-A
137	Tie Plate	8502-A

* Late models use case, Part No. 18147-A. Interchangeable with early models.

** Complete Detent and Spring Motor assembly consists of Items 119 and 119A, Part No. 18505-R.

*** New heavy-duty hardware. When replacing old hardware, order complete set; i.e., (2) 18291-A U-bolts, (2) 18292-R mast clamps, and (4) 8100-E hex nuts.