



Dr. Ing. Jochen Jirmann, DB 1 NV

Intermodulation Properties of Switching Diodes

Some attempts to improve the intermodulation properties of short-wave receivers were described in (1). It was demonstrated there that the main reason for the moderate intermodulation properties of many short-wave receivers should be looked for in the use of unsuitable switching diodes for the switching of the input band pass filters. Following numerous enquiries, the intermodulation behav-

our of commercially available high-frequency switching diodes was measured in a second investigation. The results were obtained using resources which were still almost on an amateur level, and should thus not be put down to the "dB scales". The comparison between the various diode types is actually more important than the absolute values.

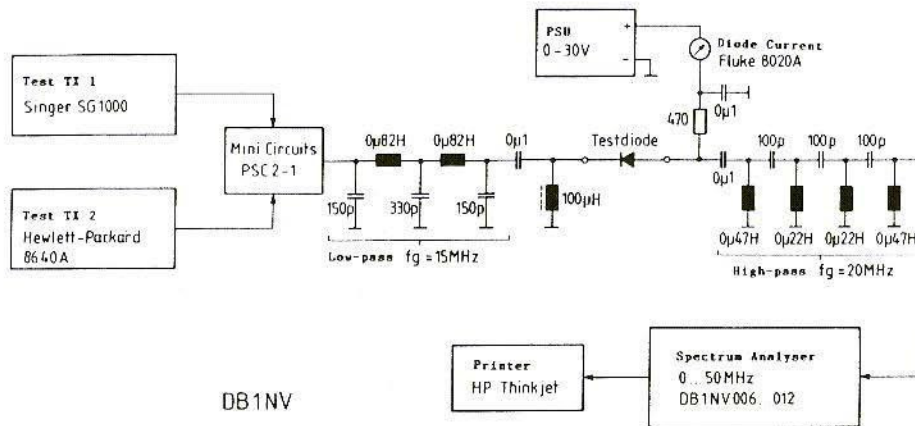

Fig.1: Measuring Rig for the measurement of the Intermodulation Characteristics of Switching Diodes



Spektralanalysator DB 1 NV, Version 1.18, vom 01.02.92
 Grafikdruck HP Thinkjet mit 132 Pixel/Zoll

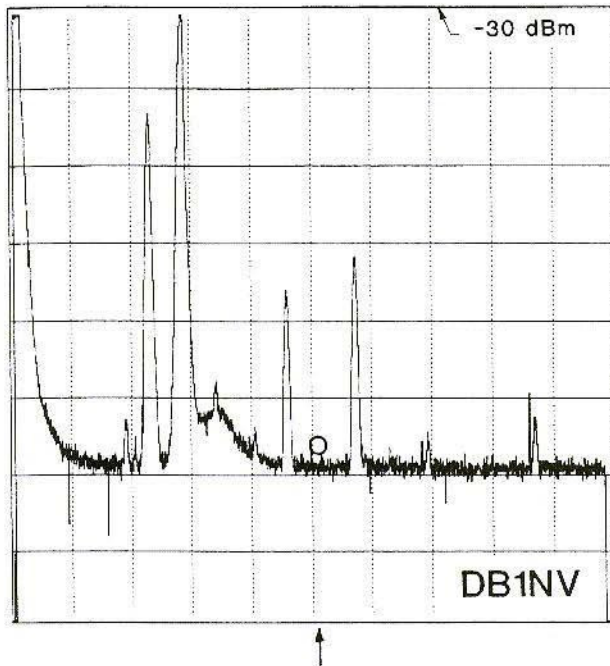

Fig.2:
Measurement Curve
without Diode (IM2
measurement).
Circle shows location
of Intermodulation
Product
SA: centre 25 MHz;
5 MHz/div

1. THE MEASURING RIG

The previous experiments, using an IC765 from OM Hercher, DL8MX, had demonstrated that the critical level above which audible intermodulations arise should be sought at an aerial voltage of about 100mV. This corresponds to an output of -6dBm. By definition, an S1 signal has a level of -121dBm, so that the measuring rig must process a dynamic range of 115dB to detect weak IM products. This is just about possible using commercial measuring technology of the most expensive kind. In order to obtain usable results with amateur resources, measurements were carried out only at selected fixed

frequencies, and the frequency diagram was drawn up in such a way that harmonics from the test transmitter can be separated from the IM products sought. With some filters, a measurement dynamic range could be usable at about 90dB. The measuring rig is sketched in Fig.1.

Two test transmitters act as signal sources, a Singer SG 1000 and a Hewlett-Packard 8640A, the outputs of which are combined by means of a power adder (Mini Circuits PSC2-1). The test transmitter power is 1mW or 0dBm. A simple low-pass filter made of proprietary chokes (Siemens MCC, 0.82 *H) with a limiting frequency of 15 MHz reduces the inherent intermodulation of the test transmitter to below -100dBm. The low-pass filter is fol-

Spektralanalysator DB 1 NV, Version 1.18 vom 01.02.92
Grafikdruck: HP Thinkjet mit 192 Pixel/Zoll

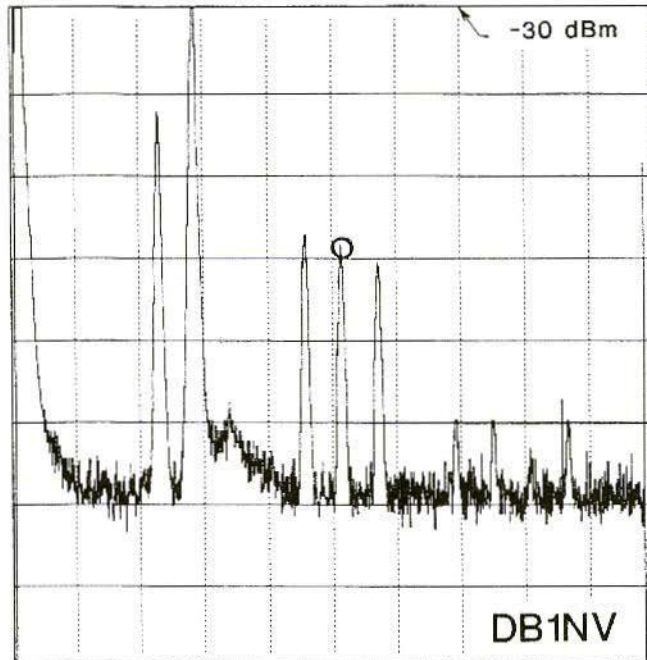

Fig.3:
Measurement Curve:
IM2 Spectrum of a
BA379 with 2mA Diode
Current

lowed by the test diode, which is biased with adjustable DC. A high-pass with a limiting frequency of 20 MHz relieves the spectrum analyser (home-made by the author) of the strong carrier wave signals from the test transmitter. The analyser was set to an average frequency of app. 25 MHz and to 5 MHz/div.

For the measurement of total frequencies (second-order intermodulation), the test transmitters operated at 15 and 12 MHz. The second-order mixed product at 27 MHz can thus easily be separated from the test transmitter harmonics at 24 and 30 MHz.

To measure third-order intermodulation, the test transmitters were set to 15.5 Hz and 6 MHz and the mixed product was measured at 25 MHz.

To check the measuring rig, the diode was short-circuited. Fig.2 shows the analyser screen print-out. The two test transmitter signals can be recognised (here 12 MHz and 15 MHz), together with their harmonics at 24, 30, 36 and 45 MHz. The reference level at the top edge of the screen was -30dBm here, so that the reduction of inherent intermodulation products could be estimated at better than 85dB. A circle marks the position of the IM product to be expected.

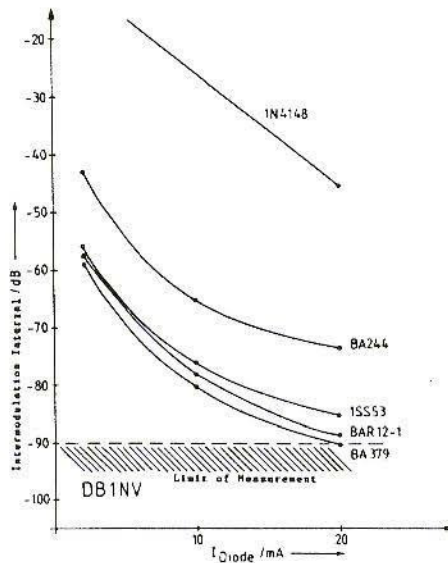

Fig.4: Second-order Intermodulation Products plotted against Diode Current

2. SECOND-ORDER INTERMODULATION

In this range, measuring frequencies of 12 and 15 MHz were used. The diode DC was varied from 2mA to 20mA. The test diodes used were a 1N4148, a 1SS53 (from an IC765), a BA379, a BAR12-1 and a BA244. A typical IM spectrum can be seen in Fig.3. Here a BA379 was operated at a low current of 2mA. The intermodulation signal can be clearly recognised at 27 MHz, with a level of -60dBm between the first harmonics of the test transmitter. The intermodulation intervals measured for

various diodes are plotted against the diode DC in Fig.4. As can be seen, the first round in the IM contest goes to the BA379 from Siemens, followed by the BAR12-1 and the 1SS53. The good cut-off results from the 1SS53 universal diode are surprising. But since the diodes removed from the IC765 carried no type description, it might perhaps be conceivable that ICOM had secretly used improved diodes here. It isn't clear from the parts list. It can clearly be seen how important a sufficiently high level of DC through the diodes is, since at current levels below 10mA the intermodulation products increase greatly.

3. THIRD-ORDER INTERMODULATION

In this measurement range, the test transmitters were tuned to 6 and 15.5 MHz and the IM product was evaluated at 25 MHz. The diode DC was altered here at only two values, 2mA and 5mA, and the same diodes were used as in Section 2. Fig.5 shows the inherent interference spectrum for the measuring rig, Fig.6 the IM spectrum for a 1N4148 misused as a switching diode with a diode current of 5mA. The reference line is at -10dBm and the IM interval for third-order products is about 20dB! Fig.7 further shows the intermodulation intervals measured for the various diodes. As can be seen, the BA379 gives the best results here too, followed by the BAR12-1, whereas the 1SS53 falls off markedly.



Spektralanalysator DB 1 RW, Version 1.18 vom 01.02.92
Grafikdruck HP Thinkjet mit 152 Pixel/Zoll

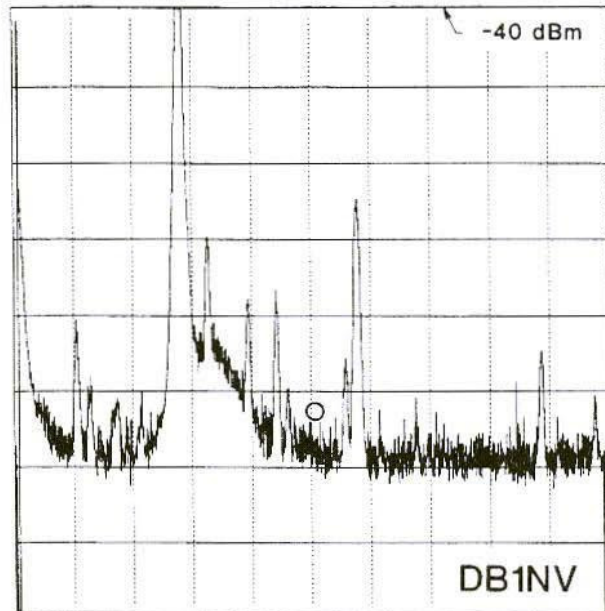

Fig.5:
Measurement Curve
without Diode (IM3
measurement).
Circle shows location of
Intermodulation
Product

4. SUMMARY OF RESULTS SO FAR

The measurement results listed essentially show four things:

- Good, repeatable intermodulation intervals can be obtained only through the use of "correct" PIN diodes, but they have their price. Miniature relays are even better, but more expensive and bigger.
- Universal diodes misused as high-frequency switches can yield very good results (1SS53) or catastrophically poor results (1N4148). Moreover, it can not be calculated what effect variations in the manufacturing parameters will have (different production lines, different production methods).
- The relatively good cut-off results obtained in practise from the apparatus fitted with tuner switching diodes is not consistent with the poor measurement results from the BA244.
- The existing apparatus should also be improved or re-constructed in order to check whether sufficient DC is flowing through the diodes. An attempt should be made to set a value of about 20mA by altering the protective resistors. It can be concluded from the results that the main cause of intermodulation interference in short-wave amateur receivers should be sought in the area of the high-frequency input switching diodes.



Spektralanalysator DB 1 NV, Version 1.18 vom 01.02.92
Grafikdruck HP Thinkjet mit 192 Pixel/Zoll

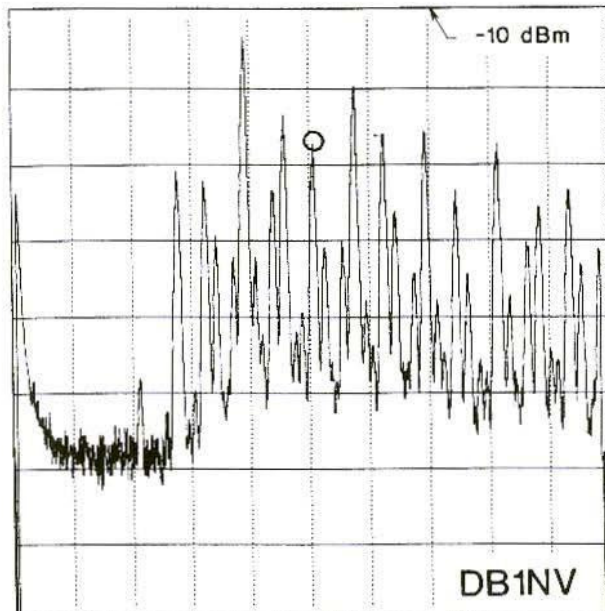

Fig.6:
Measurement Curve:
IM3 Spectrum of a
1N4148 with 5mA
Diode Current

But since over-modulated coils with ferromagnetic cores can also generate intermodulation effects, the same measuring rig was used to classify inductive components.

5. INTERMODULATIONS IN INDUCTANCES

Here both the aperiodic case (coil as choke) and the resonance case were investigated. In the latter case, the coil was brought into series resonance with a high-quality foil trimmer at 15 MHz and subjected to 12 and 15 MHz measurement frequencies. Coils or series resonance circuits were inserted into the measurement circuit instead of the diodes. The following observations were made here:

- With a choke effect, intermodulation products above -110dBm were not detected either for rod core microchokes from the Siemens MCC range or for Neosid and TOKO ready-made coils selected at random. Only the "VK200" six-bore core choke from Valvo or Philips Components, a favourite with VHF Communications readers, yielded an IM level of between 85 and 95dBm, depending on the ferrite material. A DC level of 50mA did not influence the readings for any choke.
- In resonance mode, the Neosid and TOKO ready-made coils, together with some very small ferrite ring cores, came up with IM levels of -100 to -105dBm. The Siemens chokes stayed the course amazingly well. Their intermodulation could be placed at around -110dBm. Some

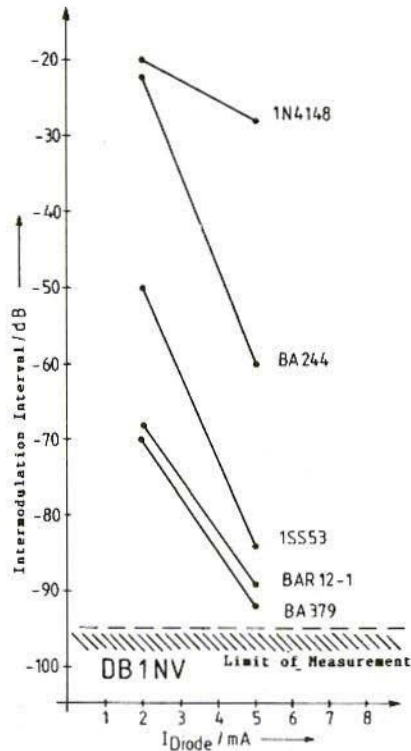

Fig.7: Third-order Intermodulation Products plotted against 2mA and 5mA Diode Currents

Amidon ring cores, suitable for short-wave use and of various sizes, were practically free from intermodulation.

The following design tips can thus be derived, some of which are in any case not new, but which have probably fallen into oblivion in Japan:

1. Input filters effectively resistant to IM can be produced only using sufficiently large iron powder ring cores as inductances. They offer the best compromise between the space requirement and the level controllability.

2. In compact rigs, rod core chokes, such as the Siemens MCC, can be considered as alternatives.
3. Chokes in the filter structure, e.g. on the operating voltage feed, are largely uncritical, as long as they do not resonate.

In this connection, we might recall the band-pass filters with ring core coils publicised many years ago by VE3TP, which were not exactly cheap to construct, but on the other hand have solved every receiver IM problem so far. This statement shows that, in spite of statements to the contrary from the industry and from a few, probably unqualified, "specialists", it is possible to produce receiver input components which can meet today's requirements in relation to sensitivity and high-level signal strength. Since in our hobby we don't need to worry about tenths of a penny, like industrial manufacturers, we can obtain results which are some orders of magnitude better for a slightly increased cost!

The author hopes that this account of his measurements will start people thinking about experiments of their own, and would be pleased to receive reports of their experiences.

6. LITERATURE

- (1) Dr. Ing. J.Jirmann, DB1NV
Wilfried Hercher, DL8MX:
Improvement in Intermodulation
Behaviour of Modern Short-wave
Amateur Receivers
VHF Comm, 1/1993 pp. 38 - 43