

KLI Data Shaper

Panduan Selangkah demi Selangkah



Perakitan & Perancangan KLI Data Shaper Demodulator & Decoder

Arman Yusuf, S.Kom - YB0KLI



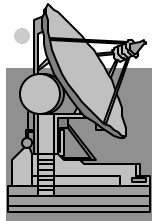

Daftar Isi

- **Daftar dan Bentuk Komponen**
- **Pengujian Setiap Komponen**
- **Persiapan Seluruh Komponen**
- **Skema Elektronika**
- **Memeriksa dari Kesalahan**
- **Penyelesaian Akhir**
- **Instalasi Software**

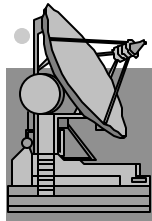

Daftar dan Bentuk Komponen

Resistor 100 KOhm



Kapasitor 100 nF

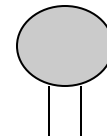

IC uA741

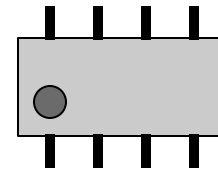

Dioda IN4148 x 2



Jack DB9/DB25

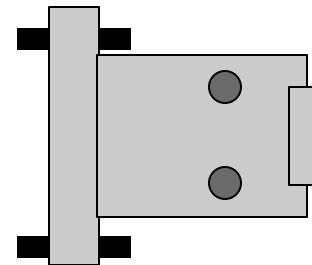

Jack Audio Mono



Kabel Audio

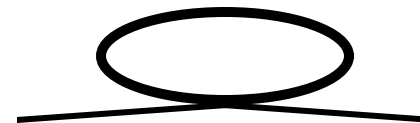

Gambar tidak dalam skala sesungguhnya

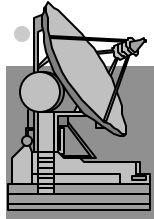

Pengujian Setiap Komponen

- **Resistor 100KOhm**

.....

- **Kapasitor 100nF**

.....

- **IC uA741**

.....

- **Dioda IN4148**

.....

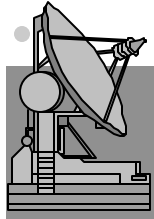

Persiapan Seluruh Komponen

- **Pembersihan kaki komponen**



- **Penekukan komponen sesuai kontur**



- **Penyolderan tipis kaki komponen**

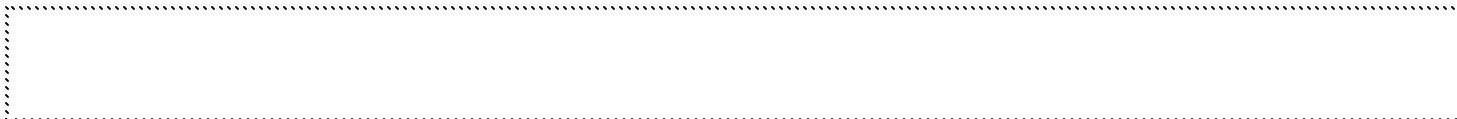

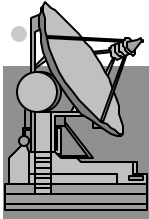

Skema Elektronik

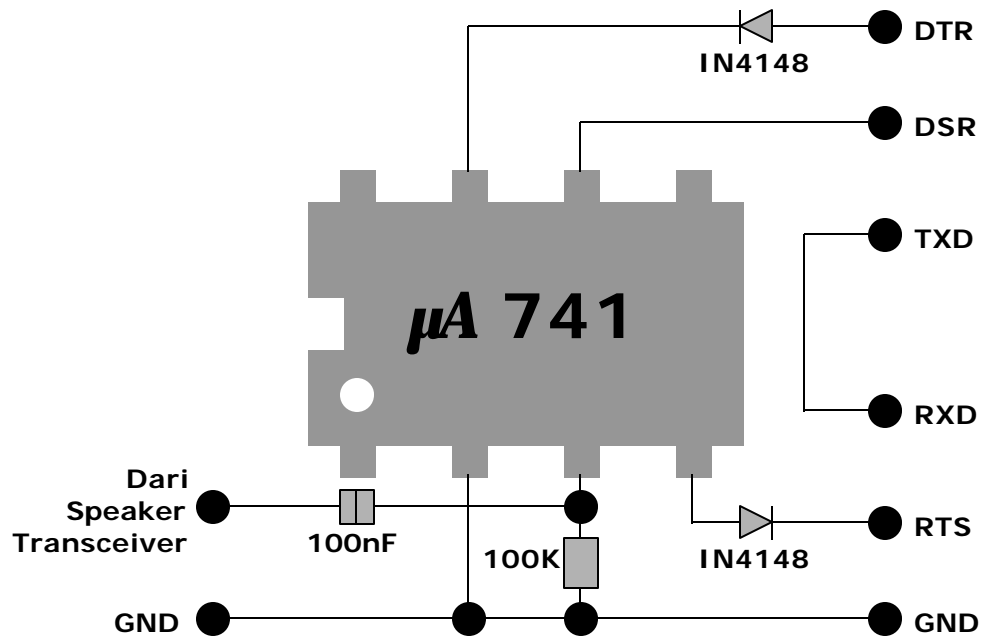

Pin	Keterangan	DB9	DB25
DTR	Data Terminal Ready	4	20
DSR	Data Set Ready	6	6
TXD	Trasmit Data	3	2
RXD	Receive Data	2	3
RTS	Request to Send	7	4
GND	Signal Ground	5	7

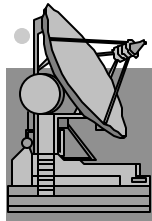

Pemeriksaan dari Kesalahan

- **Pemasangan Demodulator pada PC**
- **Pemeriksaan dilakukan pada**
- **Tegangan pin 7 dan 4 Volt DC**
- **Tegangan pin 7 dan 2 Volt DC**
- **Tegangan pin 4 dan 7 Volt DC**
- **Tegangan pin 4 dan 2 Volt DC**
- **Tegangan pin 6 dan 2 Volt AC**



Penyelesaian Akhir

- **Pastikan solder bersih, kuat & rapih**



- **Tes dengan software Decoder**



- **Menempatkan hasil dalam DB9/DB25**



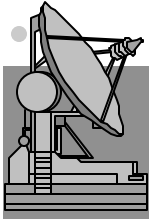

Instalasi Software

- **Software KLI Data Shaper Decoder telah terkemas dalam disket bootable. Cara penyalinan software:**

```
Finished - DECODER
KLI Data Shaper Decoder 1.0
Vol 111... Dev ...

Bismillahi-r-Rahmani-r-Rahim
KLI Data Shaper Decoder 1.0 by Arman Yusuf, S.Kom - YBOKLI
http://groups.yahoo.com/group/radio-paket/files
Drop your mail to: arman@mk.co.id

DXC -A>YB0ECT-A>SABM+
DXC -A>PI5EHV-A>DIGI -A>UI F0
DXCHAT:020815200100 0:I4LCK
MSG:df9x 912km! OK test start 1min CW 1
Franco Armenghi
Via Jussi 9
I-40068 San Lazzaro
Italy
YB0ECT-A>DXC -A>RR0+
DXC -A>YB0ECT-A>RR1-
YB0ECT-A>DXC -A>RR0+
YB0ECT-A>DXC -A>RR0+
YB0ECT-A>DXC -A>RR0+
YB0ECT-A>DXC -A>RR0+
```