

**WinDRM** was developed by Cescio, HB9TLK from a relatively new broadcast standard called Digital Radio Mondiale (DRM) and its open source encoder/decoder named Dream (<http://drm.sourceforge.net/>). DRM is based on a proven data communications technology called Coded Orthogonal Frequency Division Multiplexing (COFDM) with Quadrature Amplitude Modulation (QAM). COFDM uses many parallel narrow band sub-carriers instead of just one single wide band carrier for transporting the data. As a result, WinDRM provides an efficient and robust method to exchange information over HF including Digital Voice using open source CODECs. WinDRM utilizes Forward Error Correction (FEC) and an Automatic-Repeat-Request (ARQ) mode to ensure error free data transfers. WinDRM runs efficiently under Windows operating system 2000 and XP. No modifications are required for modern SSB HF ham transceivers. Current releases of WinDRM software may be found at [www.nl1su.com/windrm](http://www.nl1su.com/windrm). Other digital HF data/picture transfer software such as *Digtrix*, *EasyPal* and *HamPAL* share the same core ham-DRM standard and therefore are compatible with WinDRM. WinDRM is not compatible with all newer encoding methods now being used by *HamPal*. WinDRM is not compatible with AOR's ARD 9000/9800 fast radio modem.

## The WinDRM GUI (graphic user interface)

Five "State" Radio Buttons - (enabled under program control during receive ) as follows:

### Input/Output

**IO** ó Enabled: Sound card is linked and passing data to the processor. Disabled: Indicates sound card is not compatible and/or PC's processor is too slow. If not enabled,

WinDRM will not decode data. Note: IO should always be enabled during receive *and* transmit.

### **Frequency Acquisition**

**Freq** – Enabled: The three FAC reference carriers/pilots (3 higher intensity vertical lines in the waterfall displays) have been found. These correlate with the DC Offset frequency (normally 350Hz) which is graphically shown as a blue vertical line.

### **Time Synchronization Acquisition**

**Time** ó Enabled: Timing acquisition is done. This indicates the search for the beginning of the OFDM symbol has been completed. Disabled: No synchronization, (usually caused by poor SNR) distortion of the transmitted signal and/or receive band pass is too narrow. Note: False indications (flickering) can be caused by AWGN (atmospheric noise) and generally, may be ignored.

### **Frame Synchronization**

**Frame** - Enabled: Frame synchronization is completed and the start of a DRM frame (400ms) has been found. The Receiver is in synchronization with the transmitting station. Disabled: Lost frequency synchronization due to poor SNR or change in frequency (avoid ötuningö once in sync). Note: False indications (flickering) can be caused by AWGN (atmospheric noise) and generally, may be ignored.

### **Fast Access Channel**

**FAC** ó Enabled: Receiver is in the tracking mode, has received a good Cyclic Redundancy Check (8-bit CRC) and is in synchronization with the WinDRM transmitting station. FAC is a separate logical channel and modulated with 4-Amplitude Quadrature Modulation (4QAM). FAC provides bandwidth spectrum occupancy (2.3/2.5khz), call sign and other DRM transmit parameters for the WinDRM receiver. Time, Frame and FAC always precede (must be enabled) MSC channel data. Disabled: Caused by lost sync, failed CRC, QRM, change in frequency and/or distortion of the transmitted signal. FAC provides the data for the receiving WinDRM station to set it up to automatically receive data for file transfer or digital voice (no intervention required by the receive end operator).

### **Main Service Channel**

**MSC** - Enabled: Indicates actual audio and data bits are being decoded for voice, text message and/or images. MSC may be modulated using 4QAM, 16QAM or 64QAM (see DRM TX settings). 4QAM is unique to WinDRM (DRM uses 16 and 64QAM in the MSC). The larger the QAM rate the higher spectral efficiency but with lower performance (less robust in presence of errors caused by poor propagation or QRM/QRN). Robustness is improved through interleaving of the MSC symbols. This provides time diversity so that a burst of errors is spread across up to several frames minimizing the destructive effects on the received data. Like FAC, MSC enabled indicates the Cyclic Redundancy Check (CRC) has been acknowledged and good data has been received (Infoø data for MSC will increment after the CRC has been computed). Disabled: Disruptions (dropouts), text message not received, or missed

block/segment/packet image data. QRM/QSB/QRN and weak signals can cause MSC to fail or flicker during reception. A minimum SNR of 7dB generally ensures MSC will remain enabled. Note: All these radio buttons must be enabled (from decoded transmitted data) before the file/picture or voice data will be received.

**Files:** (download from: [www.n1su.com/windrm/](http://www.n1su.com/windrm/))

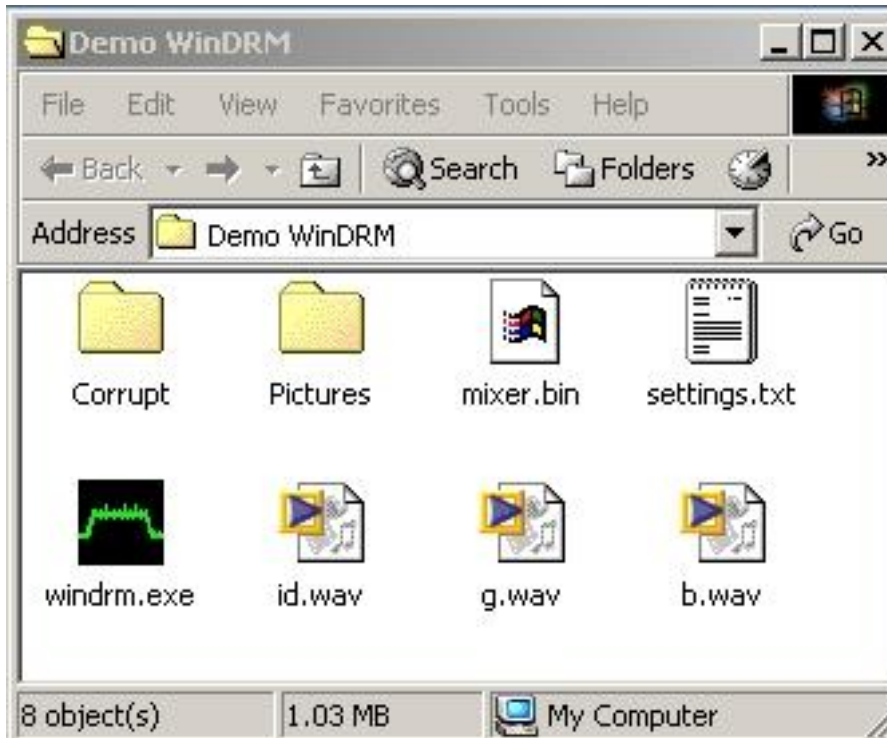

The .wav files must be created using Digtrx or similar program. For docs on how to create these files, go to <http://www.kiva.net/~djones/index.htm> . Note: These wave files are not necessary to execute/use WinDRM. WinDRM stores files/pictures with errors in the Corrupt folder. Good, error free Files/pictures are stored in the Pictures folder. Mixer.bin contains data for the sound card's mixer settings. Settings.txt file stores user settings such as com port, call sign, etc. User files/pictures to be sent may be stored in any directory for transmission, but are normally kept in the WinDRM directory for quick access. Note: Digtrx creates 16bit 8000Hz sample rate wave files. WinDRM requires 16 bit 48000Hz wave file format. Use a freeware program like Audacity (<http://audacity.sourceforge.net/>) to convert the wave files from 8000Hz to 48000Hz mono.

Other files are created by WinDRM include:

- bsr.bin
- bsr0.bin
- bsrreq.bin
- bsrreq0.bin
- RX\_Log.txt

## Known specs and definitions:

Call	KOPFX MEL	SNR	2617	Info		RX
Codec	LPC	DC	350	Mode	B/S/16/0/2.5	

### TX Data rate

MSC transmit data rate in bits-per-second (bps) is shown in the SNR box when transmitting. For the DRM TX "Default" setting this is 2617bps. The Mode box will display B/S/16/0/2.5 for this setting (see "Mode" for explanation of this data). The CODECs (Linear Predictive Coding, SPEEX and Mixed-Excitation Linear Predictive) require at least 2400bps. For data, WinDRM offers a "Speed" mode at a higher bit rate of 4362bps and a "Robust" slower bit rate mode of 997bps. By changing these DRM TX settings, the MSC protection, Coding, Bandwidth, and Interleave may be carefully chosen to match the transceiver filters and current band conditions. For HF, a good starting point is the default TX DRM setting. For poor band conditions, try the robust mode. Refer to the specs found at: [http://www.qsl.net/de/member/hb9tlk/drm\\_h.html](http://www.qsl.net/de/member/hb9tlk/drm_h.html)

### Modulation and Forward Error Correction

Carriers are modulated using 4QAM, 16 or 64 in the MSC. The QAM constellation size is selected by the user under the DRM TX settings. QAM4 is set by WinDRM for FAC since it is the most robust. OFDM/QAM modulated carriers would appear to be overlapping within their spectrum. However, once they are synchronized at the receiver, they no longer overlap (now orthogonal/unique) and can then be demodulated. QAM has both fixed amplitude and phase modulation. Forward Error Protection (FEC) is provided by Reed Solomon (RS) code. By definition, RS has the ability to produce at the sender  $n$  blocks of encoded data from  $k$  blocks of source data in such a way that any subset of  $k$  encoded blocks suffices at the receiver to reconstruct the source data. This gives DRM the ability to "repair itself on the fly" by accurately rebuilding the audio or file data as it was originally coded at the transmitter. If this cannot be done, then WinDRM keeps track of the errors (bad data segments) in the file and with the BSR, the data can be replaced with error free data using either the manual request (user intervention required) or automated using the ARQ feature in a point to point QSO.

### PC requirements

Windows OS, 2000 or XP. 700MHz minimum processor speed with 1.2GHz or higher to ensure smooth operation. Avoid executing other programs while WinDRM is decoding or transmitting. For testing/experimenting, 2+ GHz PCs can run two instances (i.e. A to B) of WinDRM in a back-to-back mode (connect sound card line out/speaker to line in/mic and carefully set levels or use Virtual Audio Cables VAC. Instance A may then be used to transmit pictures to instance B. If VAC is available (a separate program), DV may

also be demonstrated since VAC take care of exchanging data between each instance of WinDRM allowing microphone voice input to the sound card.



### Status of received data in the Info box for images (RX Pics)

The 'Info' box during receive provides a status of the data being decoded as it is received. These counters are shown in three sets of one to three digits separated with a forward slash (/). The first set is the number of memory segments (size) in the file. The second set shows the number of good segments decoded. The last set shows the segment number of the last segment decoded.

The first set of numbers represents what WinDRM 'knows about' at the start of the transmission and will change because the program begins assembling the data before the total is known. If a segment is received in error (CRC failure), a following instance provides the opportunity to receive it again. If received OK, the counter will increment. After all the data is received, the segment counts will all agree indicating the file has been received error free. If a picture was received, it will open up in Irfanview or the viewer/program associated with the file's extension. Note: The segment size increases with the constellation size (4 thru 64) of the QAM since it is possible to transmit more bits per symbol in the higher order constellations.

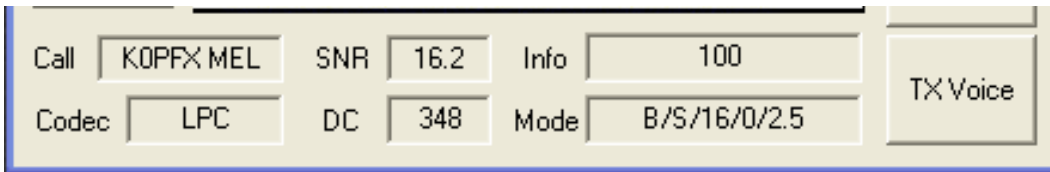

### Status of received data in the Info box for voice (RX)

While receiving voice, the Info block displays 1 to 100% representing the quality of the decoded data. The quality is determined by the number of good frames of data received \*versus bad since the last synchronization. Drop outs (speech loss) may be experienced with 70 percent or less. With SNRs of 12 or higher, expect a quality number near 100 percent (no dropouts).



## Status of transmitted data in the Info box for files (TX Pics)

After transmitting the lead in sync data, the Info box provides the status of the file as it is being sent. The counter consists of two sets of numbers separated by a forward slash (/). First set shows the instance being sent while the second set shows the percentage (1 to 100 percent) of the total segments sent. The number of instances the file will be sent is shown in the "Select File" window. A choice of 1 to 3 may be selected but additional instances can be sent by adding the file in the Select File window more than once.

## Status of transmitted data in the Info box for voice (TX)

No data is shown in the Info box during voice transmission except during the lead in sync period.

## Info box during "lead in" transmission

In both picture and voice transmissions, lead in sync data is sent to the receiving station for setting up the timing and other OFDM carrier information. This lead in maybe lengthened to provide more set up (sync) time at the receive end by selecting long lead in under the Select Files window. While the lead in is being sent (up to several seconds), the Info box will increment various numbers indicating this data is being transmitted and the actual file data has not started. Some of this data includes determining the size of the file and packetizing data prior to be sent.

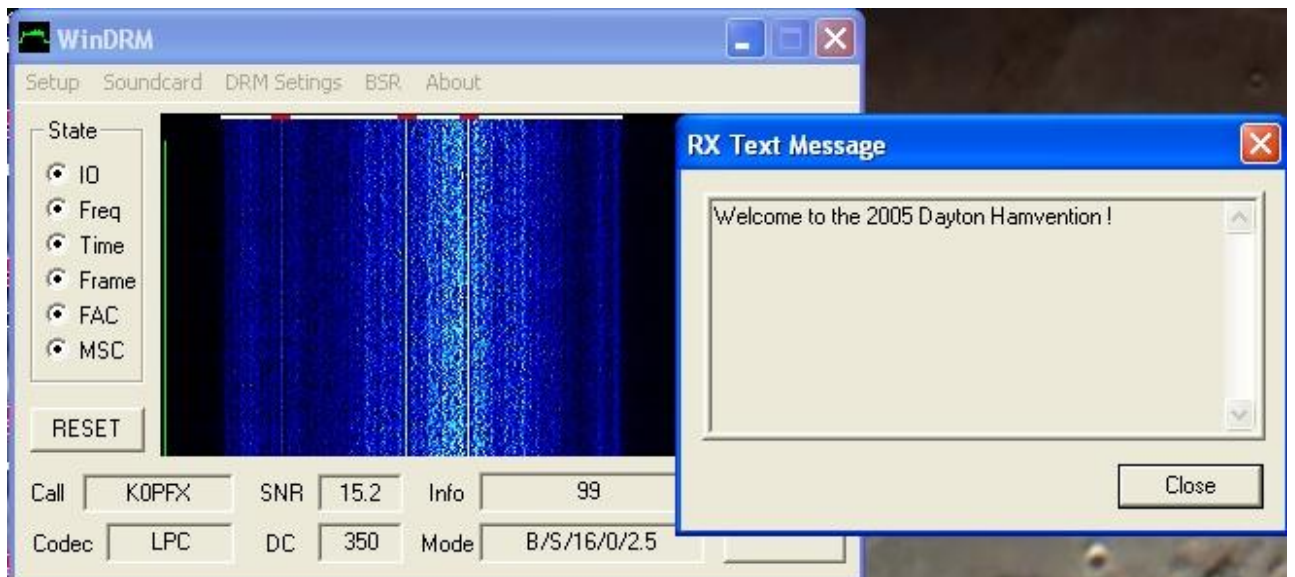

## Text Message data

Up to 128 ASCII characters (including spacing) may be transmitted. Greater than 128 will be truncated at the receive window. Text messages may not be sent with data (file/picture transmissions). Text messages may be added or changed during TX. The data rate is only 80bps, but the message is continuously transmitted during the voice transmission. In receive, the text message window remains open at the end of the transmission. This message window may be closed at any time but will re-open while



data is being received. Text messages may only be sent and received with Digital Voice transmissions.

### **Transmit and Receive parameters (and transceiver setup)**

For optimum performance, the OFDM carriers must fit within the band pass of the receiver and transmitter. The default 350 Hz DC Offset was chosen to ensure the 2.5Khz wide OFDM signal is inside both the transmit and receive audio band pass. The 350Hz is an offset from DC (0 hertz) and where the carriers of the OFDM begin. The timing (OFDM searches for this) locks on and starts all it's shifting up in frequency from the DC offset for all 57 carriers. This offset can be changed but it must be chosen so the spectrum will fit within the TX and RX band passes. If the DC is moved too much from 350, all the OFDM carriers may not fit within these band passes. Although it is not important to be exactly on the transmitting station's frequency, modern transceivers should allow the receiving station to be within 100hz of this offset frequency. Too far off frequency may result in lowering SNR if OFDM carriers fall outside the receiver's band pass. If any tuning of the frequency is made during receive, the signal is phase shifted and attenuated. The orthogonality of the OFDM symbols may also be destroyed and this causes ICI (inter-carrier-interference). This will immediately stop decoding data. Click on "Reset" to re-sync the data if any tuning must be done to bring all carriers within the band pass of the receiver. When the WinDRM users talk on SSB, carefully tune to their SSB frequency. This will ensure you are on the frequency being used for DRM data also. Be sure the receiver's band pass is at least set to at least 2.5 kHz FLAT band pass with no DSP and/or audio processing. For most receivers, setting AGC to Fast (or OFF) will improve SNR. For transmit, minimize distortion by turning off compression, EQ (or DSP filtering within the band pass) and avoid any ALC action. For 100 watt rigs, set power to approximately 15 watts average power. This mode works best with very linear transmitters and amplifiers. All commercial DRM transmitters are Class A. OFDM has a rather high crest factor caused by the mathematical FFT operation applied to the transmitted signal. The peak power is much higher (7-9 dB) than the average power read on a conventional wattmeter. Experience has found that operating out of the linear region of your transceiver and/or amplifier may result in a 3 to 4 dB *lower* SNR at the receiving station. For a detailed explanation of how to set the power out of your transmitter, go to: [http://www.tima.com/~djones/DRM\\_power.htm](http://www.tima.com/~djones/DRM_power.htm) WinDRM's Shifted Power Spectrum Density (Shifted PSD) in the absence of multi-path/QRM, will display a "Flat top" signal across the entire bandwidth of the received signal. Ask the receiving station to comment on your transmitted signal using this display. If it is not "flat", then either the transmitter or the receiving station's is not set up properly which can degrade performance.

### **CODEC**

Select under DRM TX Settings, "CODEC" (voice) or "DATA" (files/pics) being transmitted will be displayed. Under program control (FAC data), the receiving station will automatically decode and display the mode of transmission being sent (LPC, SPEEX, or Data).

### **SNR**

Signal-to-Noise-Ratio is an estimated value that indicates the quality and strength of the received signal. Experience has found, near error free data may be decoded with a SNR greater than 7.0 dB. The higher the number, the better the signal is being received. An SNR of 10 or better usually ensures error free copy. QRN, QRM, transmit distortion and propagation problems caused by multi-path cancellation lower the SNR. Transmitters and amplifiers operating out of their linear region (trying to run too much power!), failure to turn off compression or DSP/EQ and too narrow band pass all degrade SNR. Under ideal band conditions, SNR will rise to 25db or greater when both the transmitting and receiving stations are set up properly. Note: SNR is determined from the carriers between the low (725Hz) and high (1850Hz) reference pilot carriers only.

## **DC**

Refers to the frequency offset from 0 Hz to the start of OFDM carriers. Default is set at 350Hz. This is an arbitrary number chosen to ensure both the 2.3 and 2.5 kHz signal BW fits within the bandpass of the receiving station. This may be confirmed by observing the shifted PSD, transfer function displays or the moving waterfall displays. The accuracy of the receiving station's tuning for the COFDM signal is dependent upon this factor which will allow a 100-125Hz tuning error without affecting the decoding process. It is important to note however, that once sync is obtained, no further tuning of the signal should be attempted. A blue vertical line indicates the location of DC offset. Values of 50 to 5000 Hz are valid entries but 350 Hz is normally used.

## **Mode**

Displays the DRM TX settings. The default is:

**B** (DRM Mode B) **S** (Short Interleave) **16** (Main Service Channel 16 Quadrature Amplitude Modulation) **0** (Protection level) **2.5** (2.5 kHz Bandwidth). Most stations use 2.5kHz since additional carriers are available with this wider BW giving better receive performance. TX DRM modes are selected to correlate with the quality of the signal (as affected by propagation, signal strength, QRN, etc) available at the receive end. These modes affect the transmission speed and robustness of the received signal. For more info, see DRM TX Settings later in this doc.



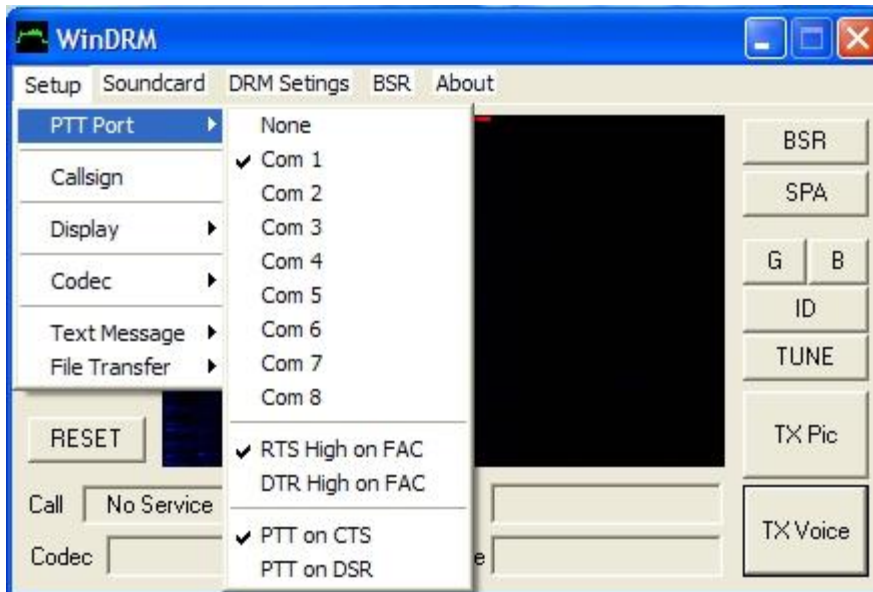

## Setup PTT Port

Any com port 1 through 8 may be selected for control of the transmitter's PTT using conventional RS232C data terminal ready (DTR) line. For most applications, a standard RS232C cable is used to connect the PC's com port to the sound card interface (RigBlaster or equivalent). In addition, the DTR or ready to send (RTS) line may be used to mute the receiver's speaker while receiving data. Implementation of this feature may be found at KB4YZ's web site. (<http://www.kiva.net/~djones/index.htm>) WinDRM may be started and the PTT controlled in the "Remote" (PTT on CTS or PTT on DSR) mode using the com port's CTS or DSR line. This Remote mode will allow the use of external switching from the PTT switch on a microphone or a PTT foot switch. To avoid a possible ground loop, an optical isolator or a relay should be used to assert (apply a positive +5 to 12vdc) to either the DSR or CTS line. Note: Due to some ambiguity between Windows OS and WinDRM, the CTS and DSR are reversed (CTS is pin 6 and DSR is pin 8 in the 9 pin Sub-D PC's com port connector). Use of a pull-down resistor on these pins will help ensure no false PTTs. For com port protection, a current-limiting resistor may be used in series with the positive voltage applied to the DSR or CTS pin. This Remote feature is not saved in WinDRM's user's settings file therefore when used, it must be checked each time the program is executed. TX voice may also be activated using the keyboard's spacebar. With "TX Voice" in focus (as show in above display), tapping the spacebar will put WinDRM in transmit (activating PTT) and pushing it again will return WinDRM to receive (a toggle function). To un-focus TX voice and avoid placing WinDRM in transmit while using the keyboard for other functions, push the keyboard's "Tab" key. Spacebar PTT will not function while in the "Remote" mode.

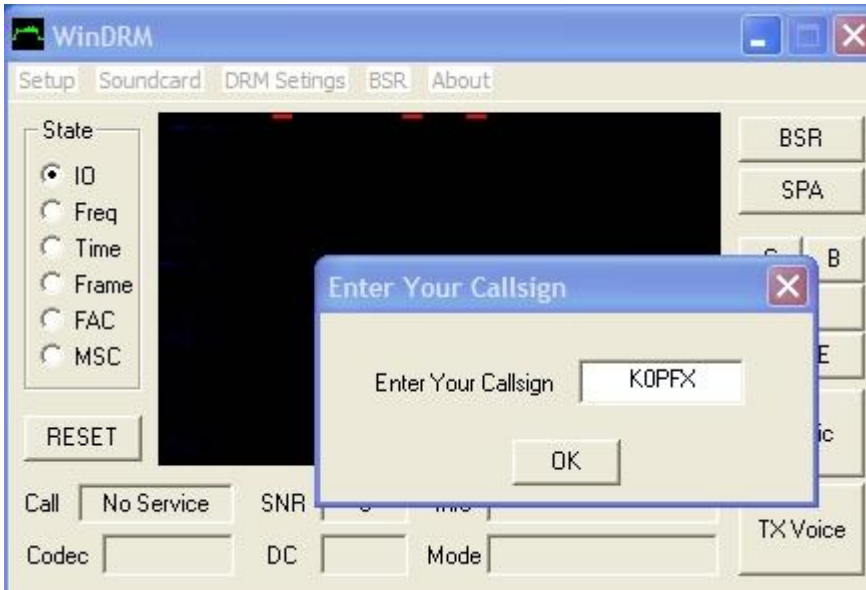

## Setup Call sign

Up to 8 number/letters may be entered. "NOCALL" is the default.

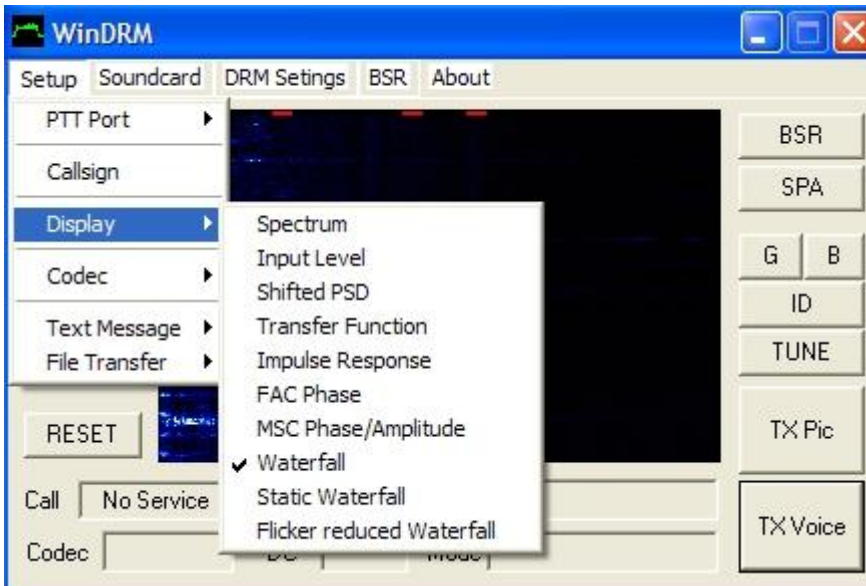

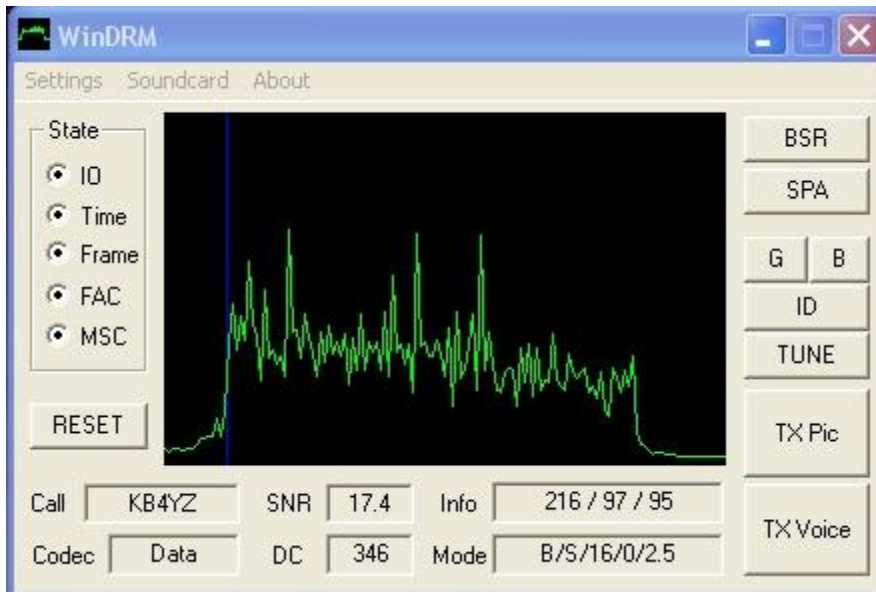

**Setup  
Display  
Receive Spectrum**

The Spectrum's display is approximately 2.5 kHz wide in the horizontal while the vertical shows the amplitude in dB (no scales are shown for any of the displays). The shape of the signal is rectangular (flat top) and represents the 2.3 or 2.5 KHz band width of the received signal. This display may be used to set the audio input level of the sound card. Too much input will over-drive the sound card (line input should always be used when available) and may cause distortion and low SNR. Carefully adjust the line input level and the receiver audio until the top of the COFDM spectrum averages approximately half way up in the display window. Although there is normally good dynamic range in most sound cards, the goal is obtain the highest SNR reading. After sync has been obtained, a blue vertical line will appear in the spectrum. This blue line shows where the timing for acquiring the COFDM signal has started (the DC offset frequency) which is normally 350Hz. This line may pop up intermittently as it will "false" on random noise and should be ignored when no valid COFDM signal is being received. The three reference pilot carriers are easily seen in the display with frequencies of 725, 1475 and 1850Hz.

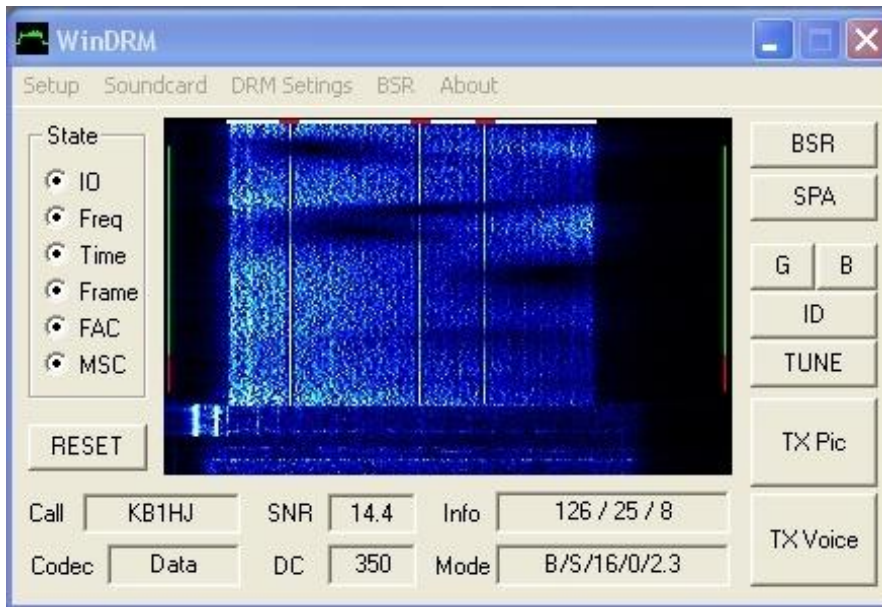

## Receive Waterfalls

Three waterfalls are available, Moving, Static, and Flicker reduced. The COFDM spectrum will be displayed with an *even* intensity level across its 2.3 or 2.5 KHz bandwidth. Within the waterfall, three FAC reference (or pilot carriers) of higher intensity can be seen. These stand out because they have higher gain (transmitted at twice the power). These FAC pilots are modulated with known fixed phases and amplitude which optimize DRM's performance for initial synchronization, duration and reliability. They are used to calculate the initial coarse frequency offset of the received DRM signal. This is the first part of the COFDM sync process and must occur before the received DRM signal can be decoded. The high-lighted red markers at the top of the waterfall display indicate where the FAC reference carriers are located when the transmitter and receiver DC offsets match. The moving waterfall sweeps from top to bottom with the red markers indicating the position of reference carriers remaining fixed at the top of the display. The moving waterfall adds a visual method to monitor the health of the decoded signal in the form of a vertical line on each side of the waterfall spectrum. During the decoding process, the green vertical lines indicate data is being received without errors and red lines indicate errors. These green/red indicators move with the spectrum instantly showing when and where the data errors occurred. The horizontal line across the top of this display indicates the bandwidth of the COFDM signal. The signal in the waterfall should fully extend the width of this line. The Flicker reduced waterfall is a modified moving waterfall designed to reduce flicker from some types of fast LCD or laptop displays. Note: The waterfall display shown above depicts the effects of multi-path cancellation as shown by the darkened (notches) areas. The carriers in this area are being attenuated due to these phenomena. The two bright lines (on the bottom left, just before the start of data) is unwanted noise (probably caused by a ground loop between the transceiver and the PC soundcard) on the Speaker Out audio line to the transceiver's Mic input. Every effort should be made to eliminate this type of interference when connecting audio cables between the PC and the transceiver. To minimize ground loop and/or RFI problems associated with sound cards and the

transceiver, refer to these informative papers found at:  
<http://audiosystemsgroup.com/SAC0305Ferrites.pdf>  
and <http://audiosystemsgroup.com/Ferrites-Ham.pdf>

**Important:** It can not be emphasized enough that common mode noise (i.e. ground loops ó ac currents) must be eliminated or risk the high probability that unwanted noise will be heard in the speaker at the receiving station while decoding digital voice. When this noise is present, it is directly proportional to the TX microphone (mixer) level input and will reduce the favorable experience expected of this mode. *Only* the decoded voice should be heard from the PC speakers.

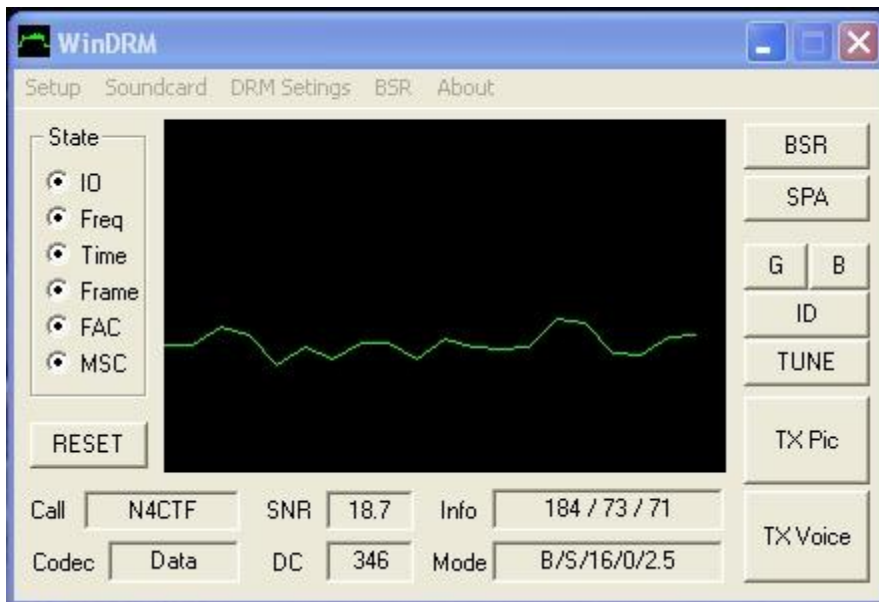

### Input Level (receive)

This display graphically shows the received audio. Sound card (recording) Line Input may be set to approximate the level as shown in the display above.

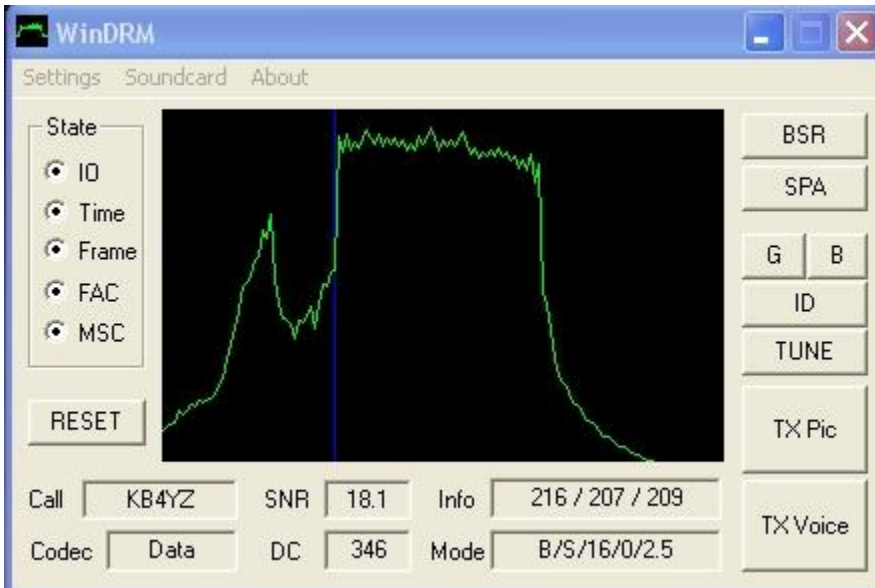

### Shifted PSD (received)

This display plots the estimated Power Spectrum Density (PSD) of the input signal. The X axis measures the PSD of 0 to 50dB while the Y axis is frequency from 0 to 12 KHz. Here the incoming DC frequency (350 Hz) is mixed with 5650 Hz to give a 6 KHz (the blue vertical line is correctly shown in DRM mode B only). The peak on the left is the mirror image ( $5650 - 350 = 5300$  Hz) and is partially suppressed by the WinDRM's internal IF filter. If a peak is displayed between the signal and the mirror signal, a 50/60Hz noise could be in the transmitted audio from ground loop. The three peaks seen at the top of the waveform are the pilot carriers for sync and have twice the power. Any roll off or dips in the waveform indicate the carriers in these areas have a loss of power caused by QSB and/or attenuation in the band pass of the transmitter or receiver. If the transmitter or receiver does not allow the 2.3/2.5kHz wide (350 to 2850Hz) DRM signal to pass without attenuation, this waveform will roll off on either end. Up to 10dB or more SNR can be lost because careful attention has not been taken to properly set up the transmitter, receiver and soundcard for the flat OFDM spectrum.

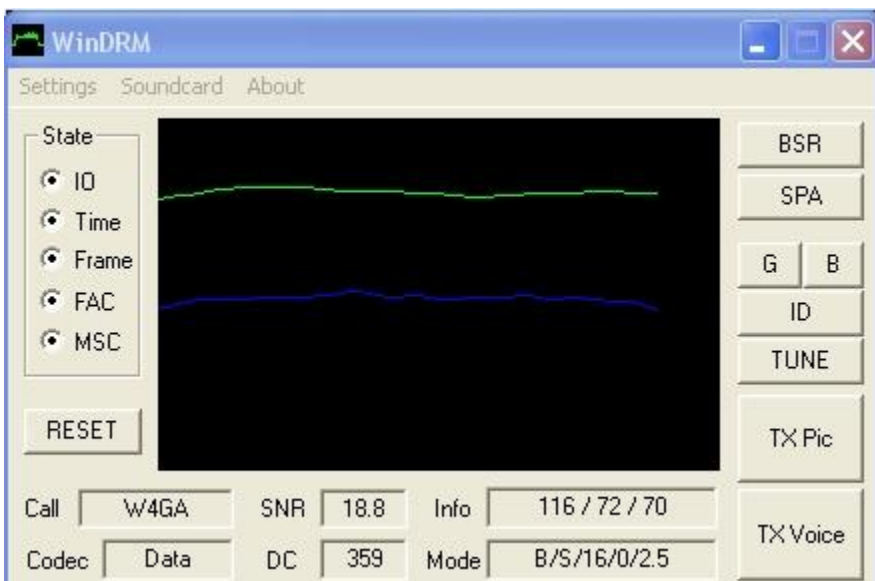



## Transfer Function (receive)

This plot shows the squared magnitude of the channel estimation at each sub carrier. The green line is the transfer function (TF in dB) while the blue line shows the phase distortion of the channel (Group Delay in ms). Optimum signals will yield a flat response and display even/flat lines across the width of the display.

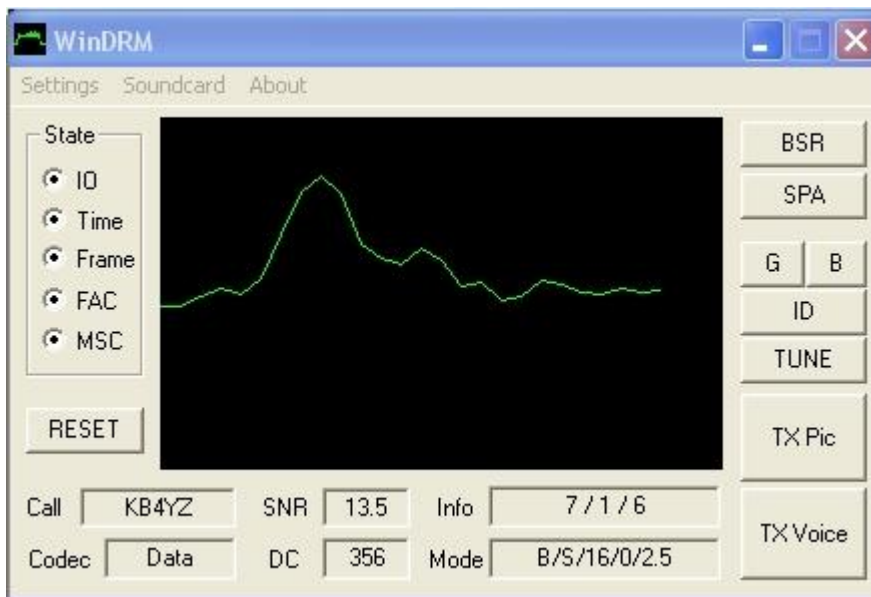

## Impulse Response (receive)

This plot shows the estimated Impulse Response (IR) of the channel based on the channel estimation. This pulse is used in determining the HF channel's frequency and phase characteristics so the signal may be restored as close as possible to what it looks like at the transmitter. The time delay of the shortest path is taken as the zero reference for the estimated pulse response.



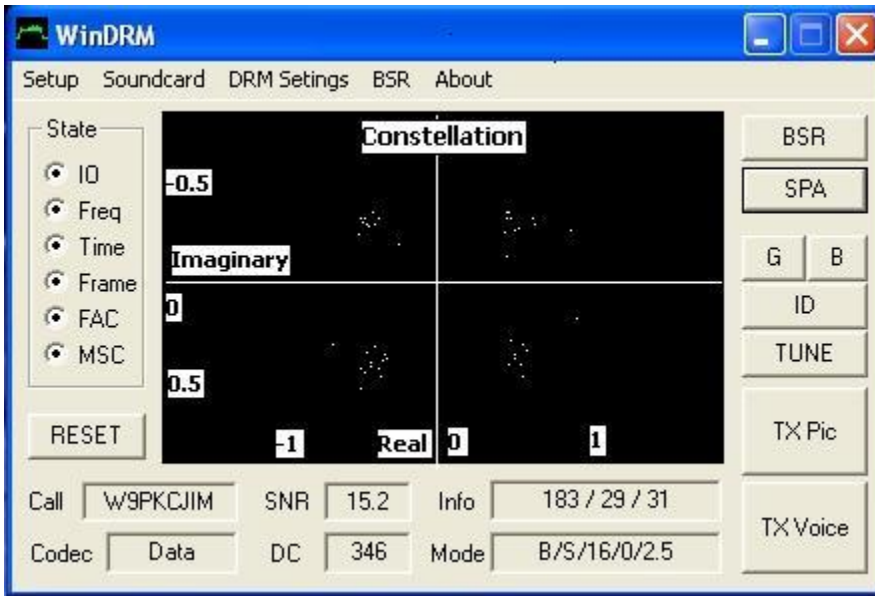

### Fast Access Channel (FAC) Phase (receive)

This plot shows the 4 QAM rectangular constellation. For more info on QAM see above info under FAC radio button and this URL:

[http://en.wikipedia.org/wiki/Quadrature\\_amplitude\\_modulation](http://en.wikipedia.org/wiki/Quadrature_amplitude_modulation)

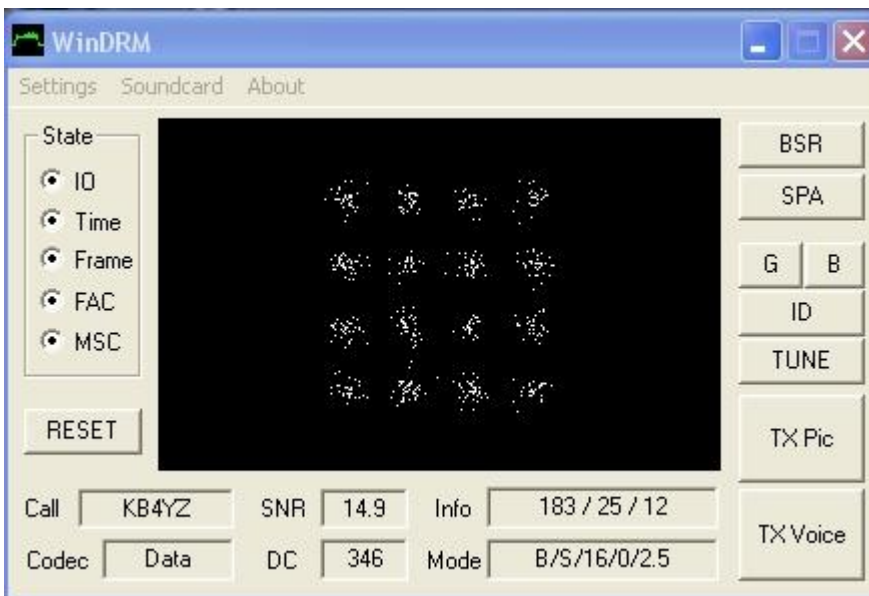

### Main Service Channel (MSC) (receive)

This plot shows the various constellations for a 4 through 64 QAM logical channel that provides the voice and file data. High SNR keeps the points in a close (tight) constellation but some scattering is expected on HF where the Reed-Solomon error

correction coding is applied. QAM varies the amplitude and phase of each one of the carriers (for 16 QAM and up). Then, through frequency multiplexing (adding these carriers together across the 2.3/2.5 kHz BW) the OFDM is created. 16QAM is shown here.

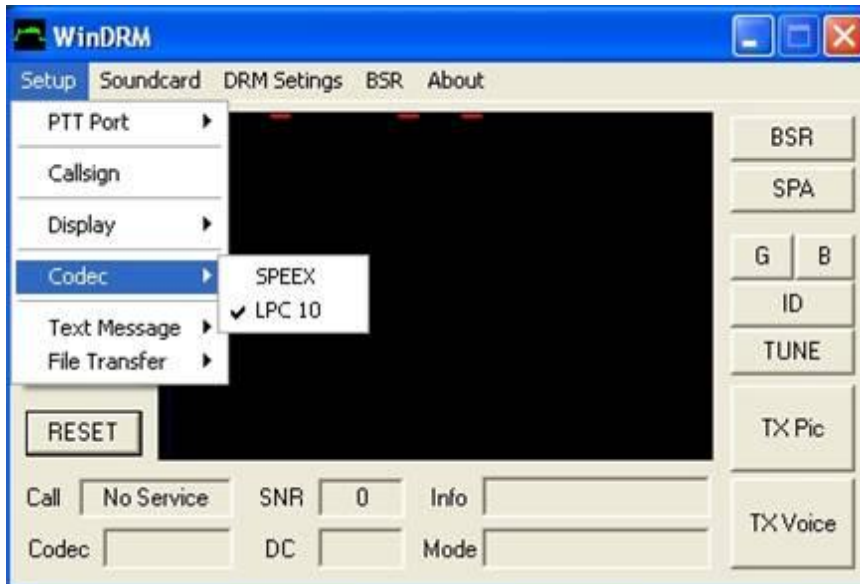

## Setup CODEC

Either Linear Predictive Coding (LPC) or SPEEX open source CODECs may be selected for digital voice. LPC is the default. All three require 2.5 kHz/2400bps minimum data (default DRM TX settings provide this for the MSC). For further understanding of these CODECs, see: <http://www.otolith.com/otolith/olt/lpc.html> and <http://www.speex.org/>. Robust DV is not easy to do on HF and may never meet everyone's needs. A couple of seconds delay is required for sync before voice can be decoded therefore fast break-ins are not currently possible. And, DV is not as robust as SSB.



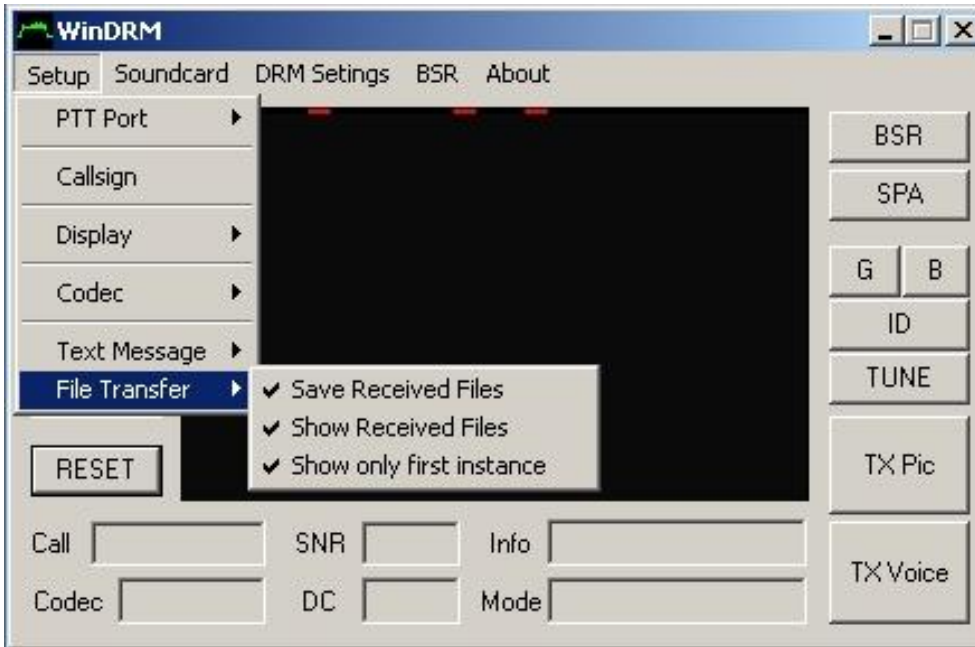

## Setup

### Save Received Files

Checked (default) indicates files received without errors will be saved in the sub-folder of WinDRM named "Pictures". If a file is missing segments, it will be saved in the "Corrupted" subfolder. Both of these folders are initially created by WinDRM.exe.

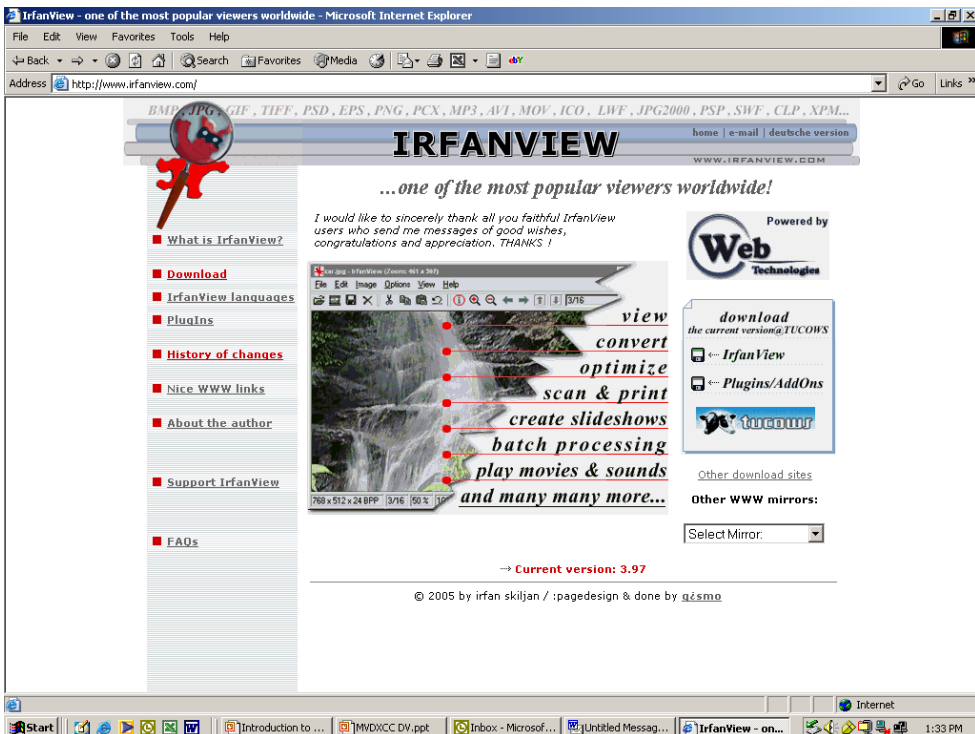

## Show Received Files

Checked (default) indicates error-free files will automatically be displayed (when associated with a viewer such as Irfanview). Irfanview is the viewer of choice and may be downloaded free at [www.irfanview.com](http://www.irfanview.com). Irfanview requires a plug-in and must be associated with the image file extensions (.jpg, jp2 etc) to display pictures. In Irfanview, go to Options>Set File Associations>Extensions then select "Images Only" or just check the extensions you wish Irfanview to display. Note: Received files and pictures will be saved in the Pictures or Corrupt folders even if no viewer has been configured. Note: Plug file name is typically named irfanview\_plugins\_XXX.exe (XXX = version).

## Show Only First Instance

Checked (default) indicates only a single instance of an error-free file will be displayed when received multiple times.

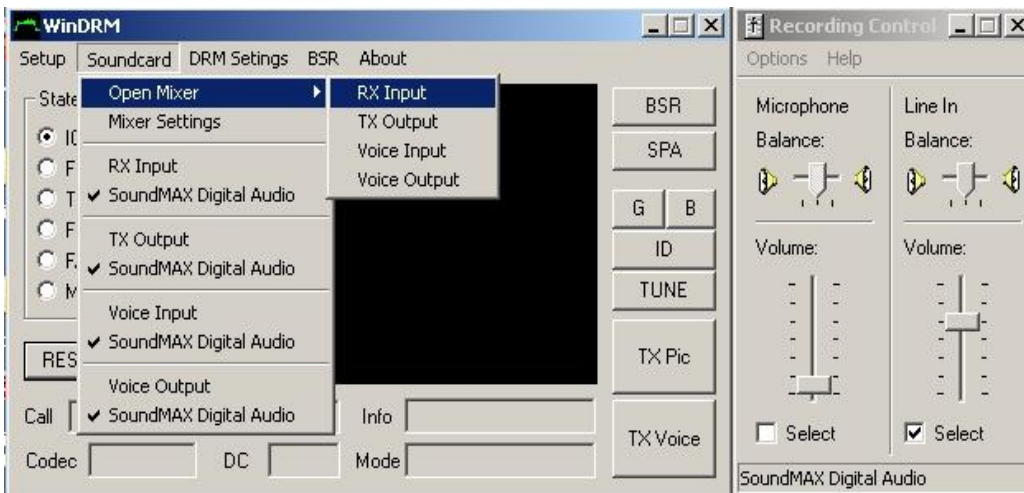

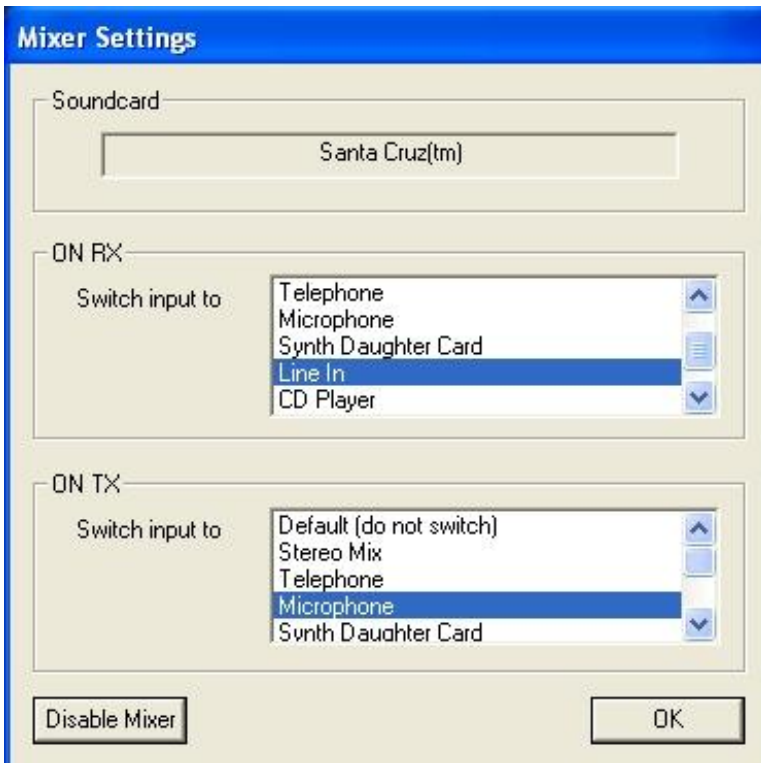
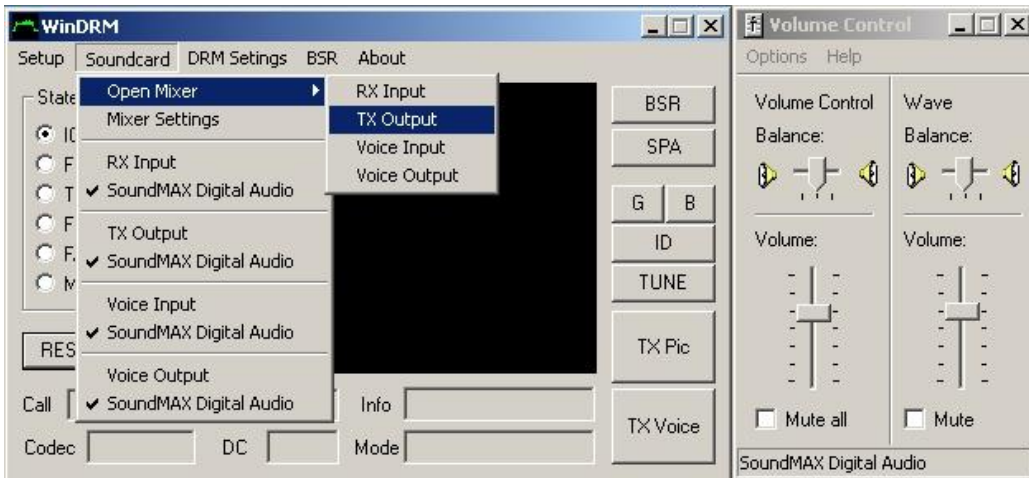

## Soundcard

Opening the mixer will display the sound card's 'Recording' and 'Playback' sliders for Audio in and out. These are associated as follows:

RX Input = Mixer Recording Line-In (connect to receiver's speaker)

TX Output = Mixer Playback Master Volume (connect to transmitter's microphone input)

Voice input = Mixer Recording Mic-In (connect PC microphone to soundcard)

Voice output = Mixer Playback Master Volume (connect to amplified PC speakers)



For Digital Voice using a single sound card, inputs are switched under program control (receive line-in switched to mic-in for transmit). Adjust mixer sliders for proper input and output levels. Start with the sliders approximately one-third up. Only the RECORDING microphone should be enabled. For transmit, PLAYBACK Master Volume and Wave Out must be selected. Use the Master Volume for the coarse adjustment and Wave out as the fine adjustment. Note: Uncheck/deselect *all* other inputs/outputs. For decoded Digital Voice, Mixer Playback Master Volume must be manually switched between the PC's amplified speakers for receive and the transmitter's mic input for transmit. If two sound cards are available, set up one card for Receive and the other for Transmit. Then, no manual switching will be required. Note: For ease of setup/use, two sound cards are *highly recommended* Digital Voice. It is very easy to add a second sound card especially if it is a USB. A low cost USB 2.0 to Audio Adapter w/Microphone Jack card for (under \$10) may be found at [www.geeks.com](http://www.geeks.com). This is a thumbnail size card (p/n HE-280B) and requires no additional drivers for XP. Just plug it in, XP finds and installs the drivers and WinDRM will display both cards under Soundcard. USB headsets may also be used (i.e. Logitech 250/350) For further help with the Soundcard Mixer, see <http://www.sagebrush.com/mixtech.htm>

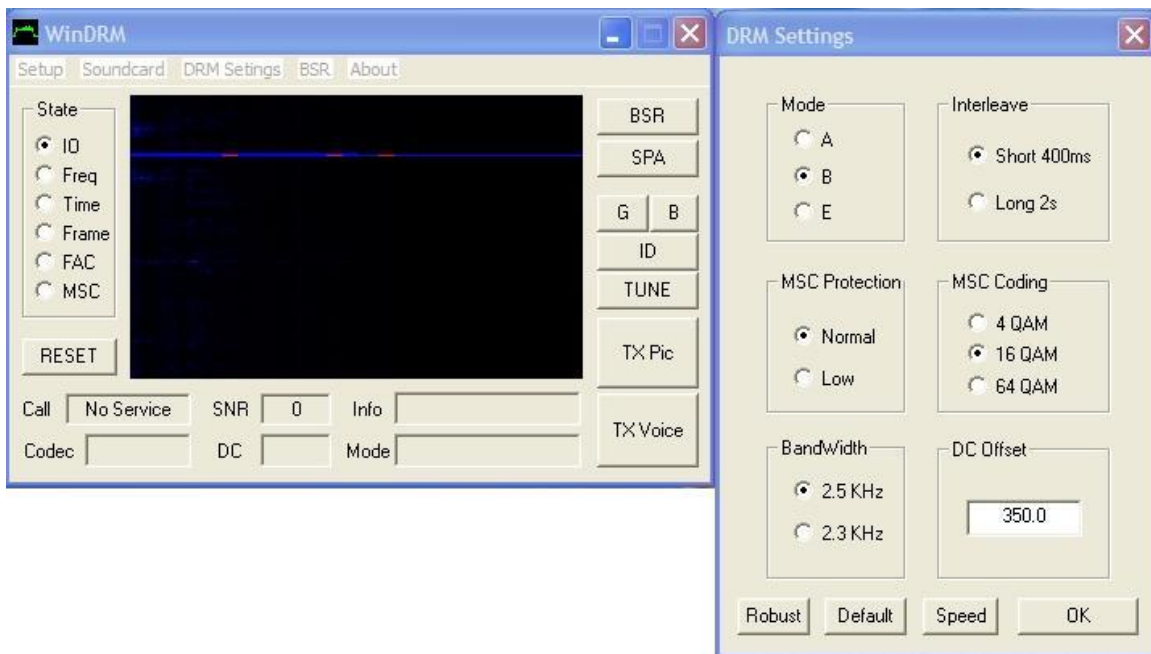

## DRM TX Settings

Mode A/B/E (A = Ground wave B = Single to multi hops E = NVIS Multi-hops)  
 MSC Protection (Normal = 0 Slower Low = 1 Faster)  
 BandWidth (2.3Khz ó 2.5Khz)  
 Interleave (Short 400ms ó fast QSB Long 2sec ó Slow QSB)  
 MSC Coding (4/16/64 Quadrature Amplitude Modulation)  
 DC Offset (50-350-5000Hz)

Clicking the Default button will result in the following DRM TX settings:



Mode	MSC Protection	Bandwidth	Interleave	MSC Coding	DC offset
<b>B</b>	<b>Normal</b>	<b>2.5</b>	<b>Short</b>	<b>16QAM</b>	<b>350</b>

*Robust* lowers the transmission BPS by changing 16QAM to 4QAM. *Speed* raises the transmission BPS by changing Mode to A, MSC protection to Low and Interleave to Long 2 seconds. Long interleave requires additional sync time. Voice requires 2.5kHz bandwidth for the 2400 bps CODECs. 64QAM on a HF channel requires a higher SNR and minimum multi-path to perform well. MSC Protection A, B and E provides different levels of forward error protection (FEC) to protect the MSC from the detrimental effects of QSB/QRM/QRN. B is higher than A with E (known as D in DRM) for Near Vertical Incidence Skywave (NVIS) transmission where the signal is transmitted with a very high angle of radiation short path propagation. In practice, however the extra protection for this mode appears to have limited results. In DRM, Mode A is used for ground wave propagation where Mode B for single hop/multiple hop propagation. The default mode on HF has shown to have the best overall performance. Mode E has been shown to be the most robust in the presence of multipath and weaker signal levels.

Note: A BSR *request* may be made using different (larger to smaller QAM constellation) DRM TX settings. This is sometimes done under poor band conditions in attempt to get the request through lower SNRs. However, the originating station responding to this request must send the response to this request (õSend bad segment reportö) in the *same* DRM TX settings it was originally sent.

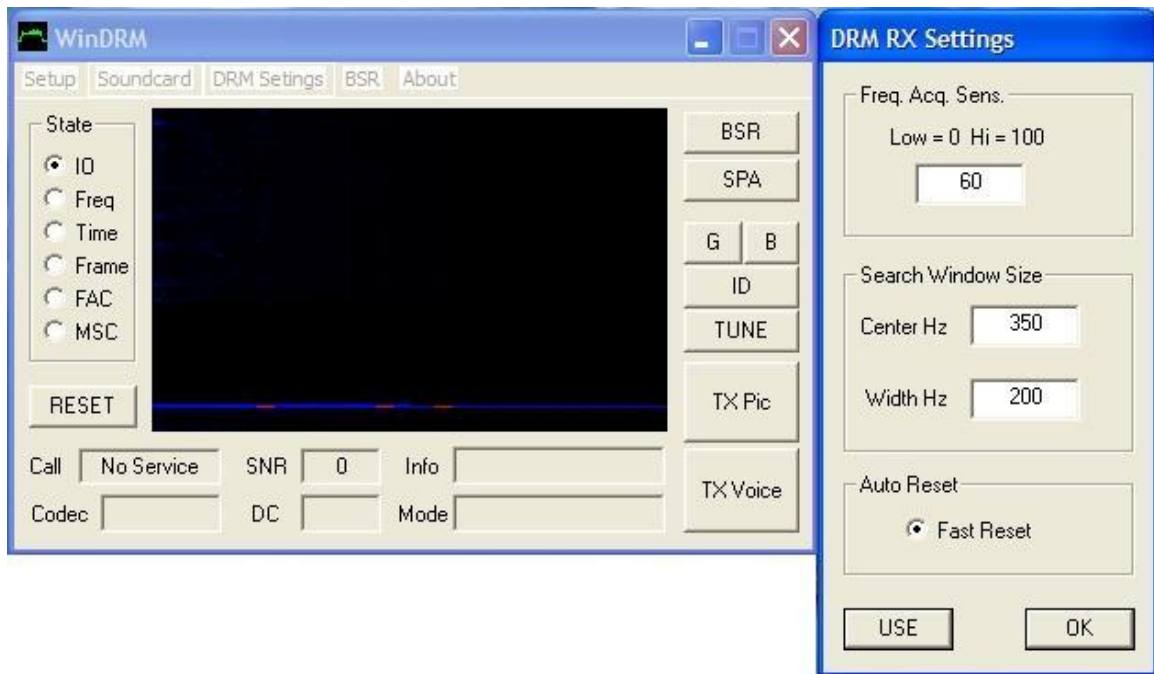

## DRM RX Settings

Default settings are:

Freq. Acq. Sens.	Search Window Size	Auto Reset
<b>60</b>	<b>350</b>	<b>Enabled</b>

Higher settings increase sensitivity for weak signals but with higher probability of false sync. Fast Auto Reset has shown to be effective in providing faster sync recover under poor signal conditions. These settings work well in the default mode, however this is a good area for hams to experiment and find what settings are best under varying signal/band conditions.

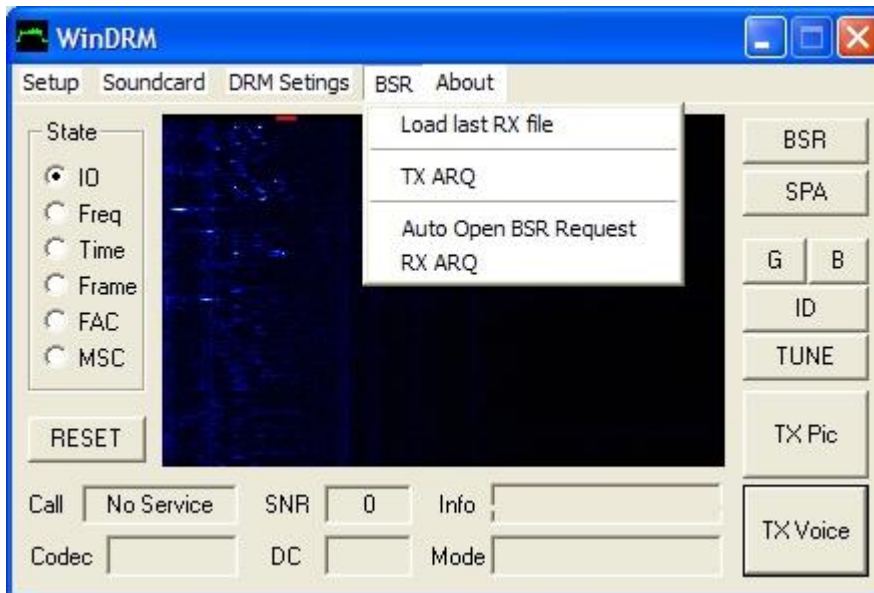

### **BSR** (Bad Segment Report ó *automated*)

BSR provides a procedure to repair (sometimes called a "fix") a defective file or picture. Normally, a defective file or picture is caused when the received station does not receive all the memory segments error free (segment failed CRC check). Depending upon how many segments were not received, the picture may not be displayed using the SPA (Show Picture Anyway) or will appear unclear/blurry. When this happens, clicking on the "BSR" button will open a window and show the number of segments "missing". The received station may then send a BSR "Request" to the sending station and request these missing segments be resent so the file (picture) may be repaired and displayed. This is the manual method and requires user intervention. The "automated" BSR completely automates this procedure for P2P (point to point) transfer of files. Auto Open BSR request, TX ARQ and RX ARQ must be checked to initiate this procedure. Note: WinDRM does not look for activity on the frequency. The procedure simply relies on timing between the tx to rx and rx to tx change-overs and does not "listen" on the channel for other activity. Therefore, users should maintain control of the station while this automated BSR is being executed, i.e. "attended" operation. Upon a successful Auto ARQ exchange, the sending station will send "Good Copy" to the receive station's waterfall. Note: Up to 30 additional segments are sent in with the receiver's BSR. These "additional" segments are sent to ensure the receiving station is in sync. Up to four multiple BSRs windows may be open at one time. These requests may be transmitted one

at a time or all can be transmitted by clicking on the "BSR send" button while any one of these request are being made (during transmission).

### Load last RX file

When selected, the last error free file received will be loaded in the "Select Files" window. This is normally used when the entire file is to be re-sent.

### Auto open BSR request

Automatically opens up the BSR window when a defective file is received. This must be checked to initiate the automated BSR procedure.

### TX ARQ

Automates the "send" request for the BSR

### RX ARQ

Automates the "receive" request for BSR Note: For auto BSR, both transmit and receive stations must have Auto open BSR Request, TX ARQ and RX ARQ checked.

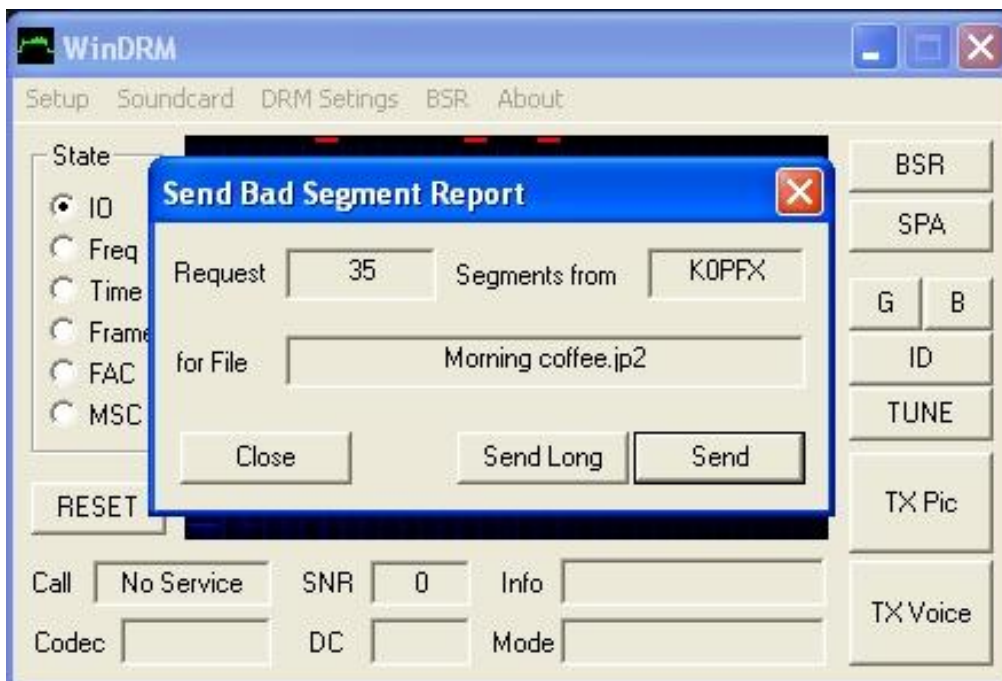

BSR (button)

### Bad Segment Report

When a picture is received with segments missing, a left click on this button will display the number of segments. Press "OK" to request these segments be re-sent.



SPA (button)

### Show Picture Anyway

Left click on this button will attempt to associate and display the last received picture even if it the file is incomplete. If there is enough data for the picture to partially assemble the picture, it will be displayed. Dependent up on the amount of missing data (memory segments) and preference of the received station, the user may then click on the BSR button to show the number of segments missing. Now, the BSR the request can be made to resend the missing data. The picture above is an example of a picture displayed using the SPA with missing segments.



Picture shown "repaired" after receiving the missing 35 segments using the BSR request procedure. Note: This entire procedure may be automated when the "Auto Open BSR," "TX ARQ" and "RX ARQ" checked.



Example of the transmitting station responding to a BSR request. Note: This is not the data used in the previous repaired picture.



**G** (button **G** works with Windows XP only)

**Good** (good picture received)

Left click on **G** will transmit a pre-recorded wave file displaying "GOOD" in the received station's waterfall. Filename: g.wav

**B** (button **B** works with Windows XP only)

**BAD** (bad picture received)

Left click on **B** will transmit a pre-recorded wave file displaying "BAD" in the received station's waterfall. Filename: b.wav



**ID** (button  $\delta$  works with Windows XP only) Left click on **ID** will transmit a pre-recorded wave file displaying the transmitting station's call sign in the received station's waterfall. Filename: id.wav

For help in creating these wave files, go to KB4YZ's web site:  
<http://www.kiva.net/~djones/index.htm>



### **TUNE** (button)

Left click on TUNE will transmit a pre-recorded wave file for setting the proper output level of the transmitter. Three reference pilot (sync) carriers will be displayed in the received station's waterfall. From left to right, A=1850Hz, B=1475Hz and C=725Hz. With a properly adjust transmitter (good linearity  $\delta$  not overdriven!), the receiving station will *only* see these 3 carriers. Any others displayed (at the receiving station) are products of inter-modulation distortion which will degrade performance. See KB4YZ's WinDRM tuning file at <http://www.tima.com/~djones/drmtune.htm>. Non-linearity can cause spectral re-growth of unwanted carriers. Driving the typical transceiver and/or power amplifier too hard will cause this spectral regrowth (unwanted carriers). Yes it is just as bad as it sounds and it should be avoided. Drive 100w transceivers to only 20w max average and a typical 1kw amps to 200w average power. For the adverse effects caused by non linear transmissions, see [http://www.tima.com/~djones/DRM\\_power.htm](http://www.tima.com/~djones/DRM_power.htm)

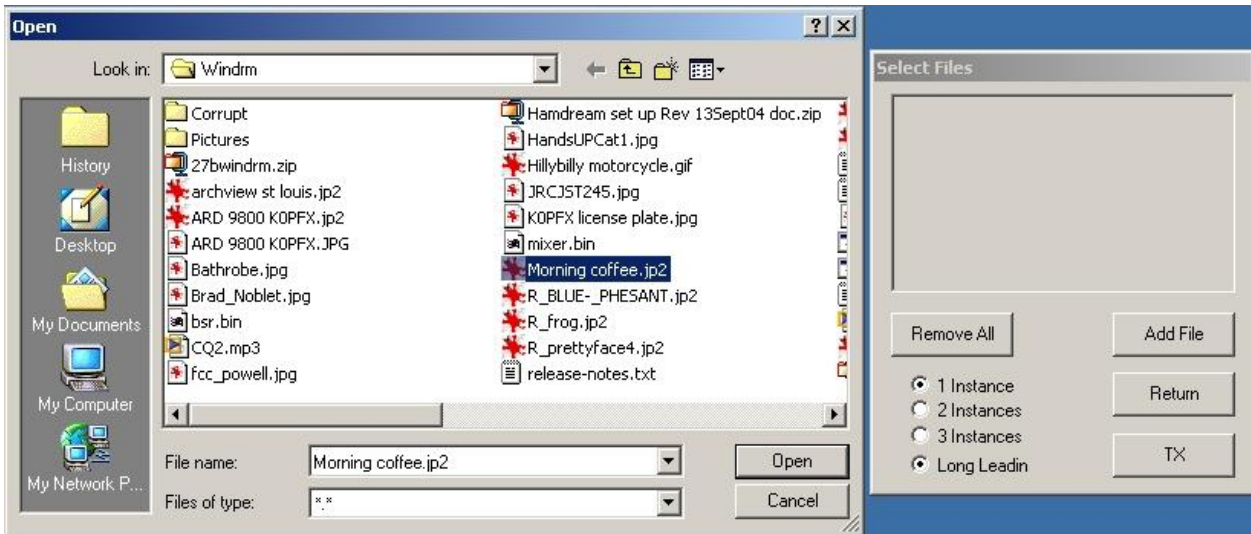

### TX Pic (button)

Left click opens a window to add or remove files for transmission. Radio buttons enable from 1 to 3 instances of the file be transmitted. Additional instances of the same file may be sent by adding the file multiple times in the Select Files window. Long Leadin increases the time for sync data at the beginning of the transmission. This is used in the presence of weaker signal conditions or QRM to help ensure the sync is made at the receiving station prior to sending the file data. *Return* button closes and returns to the opening WinDRM display. *TX* button starts transmission of sync data followed by the file data.



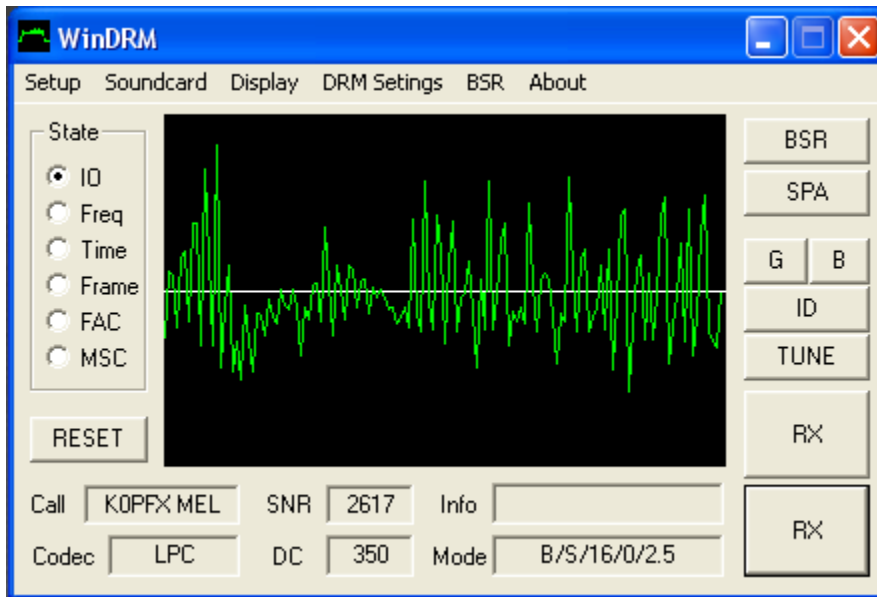

### TX Voice (button)

Left click starts a voice transmission (or if in focus, tap the spacebar). The microphone must be connected to the soundcard's MIC input. The display graphically shows the transmit microphone level (sound card's microphone input). Adjust the mixer's Record slider while speaking across the PC microphone. Best results will be found when the microphone input level is kept rather low while speaking in a loud tone of voice. Keep the average level so peaks fill approximately 50-75% of the display. Speaking too loud will cause the display to turn red. Some PC electret microphones have poor non-linear response and may sound basey yet tend to accentuate the highs which cause high peaks and distortion in this application. Experiment in this area to find the best microphone and level for the highest speech quality. The audio filter may help the intelligence of the speech in some conditions. SPEEX sounds like it adds more fidelity to the speech (when compared to LPC) but at the same time, it is a bit muffled and tends to flatten the input easier. This is an area where a well chosen microphone (such as a one from Heil Sound) will improve the voice quality. The input impedance of most sound cards microphone is approximately 2500 ohms. This impedance may vary but should be a consideration when choosing a microphone. The TX button name changes to RX while transmitting. Echo of the decoded voice may be caused by some combinations of PC and soundcard. This may be a soundcard latency problem related to the timing and transfer of data or a ground loop. Changing sound cards may correct this problem. Known good low cost sound cards include M-Audio, and Sound Blaster Audigy series. When retuning to Receive, the button label will momentarily display Wait (for approximately 2 seconds) while the transmit buffer empties. If the Remote feature is activated (PTT on DSR or PTT CTS checked under Setup>PTT Port), the TX Voice button is disabled and will display Remote.

Note: A very small low cost (less than \$10 USD) USB sound card by C-Media (HE-280B) has shown to perform very well with WinDRM. It may be found at [www.geeks.com](http://www.geeks.com) Or use a USB headset such as the Logitech model 250 or 350.

## RESET (button)

Reset re-starts the sync process in receive. Normally, this button is rarely needed.

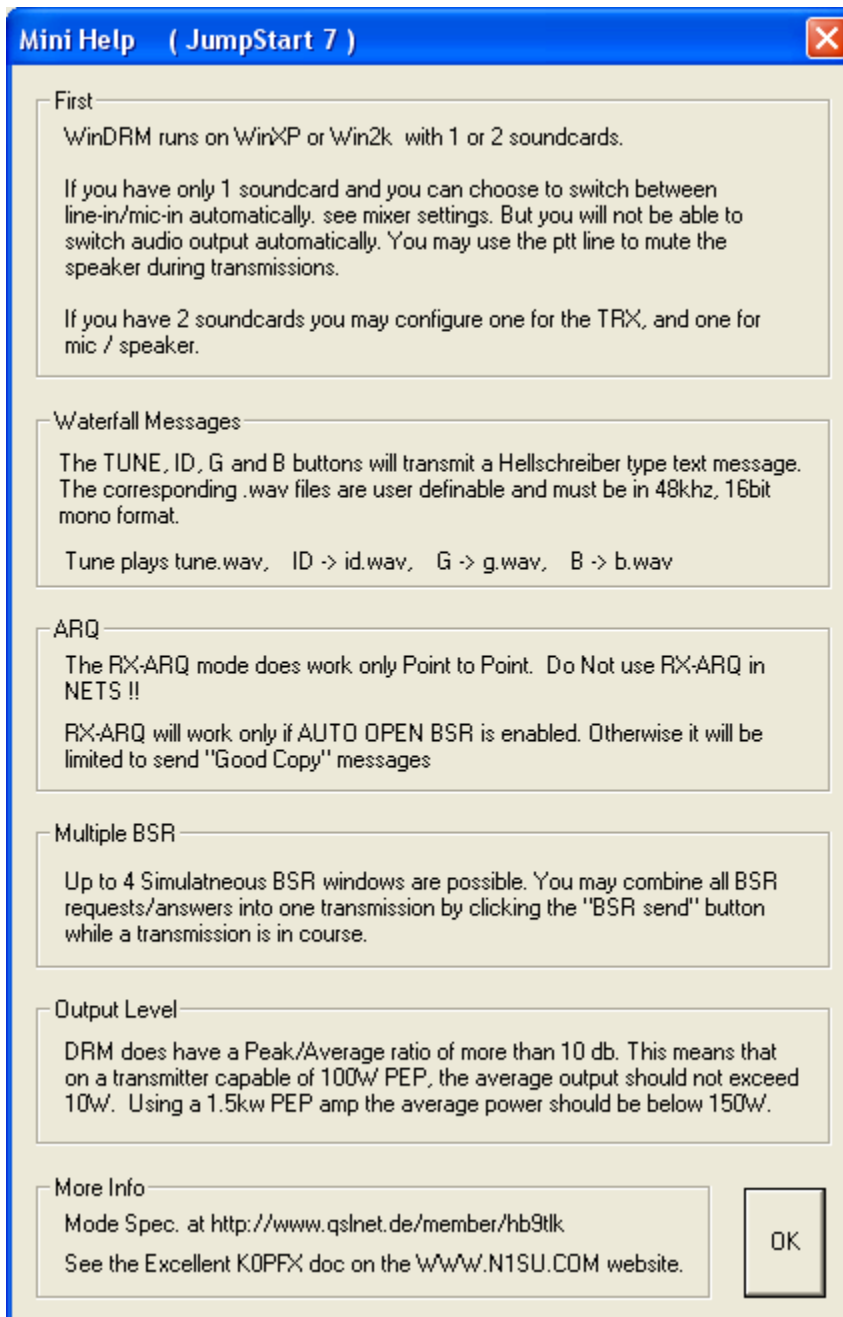

## About Info

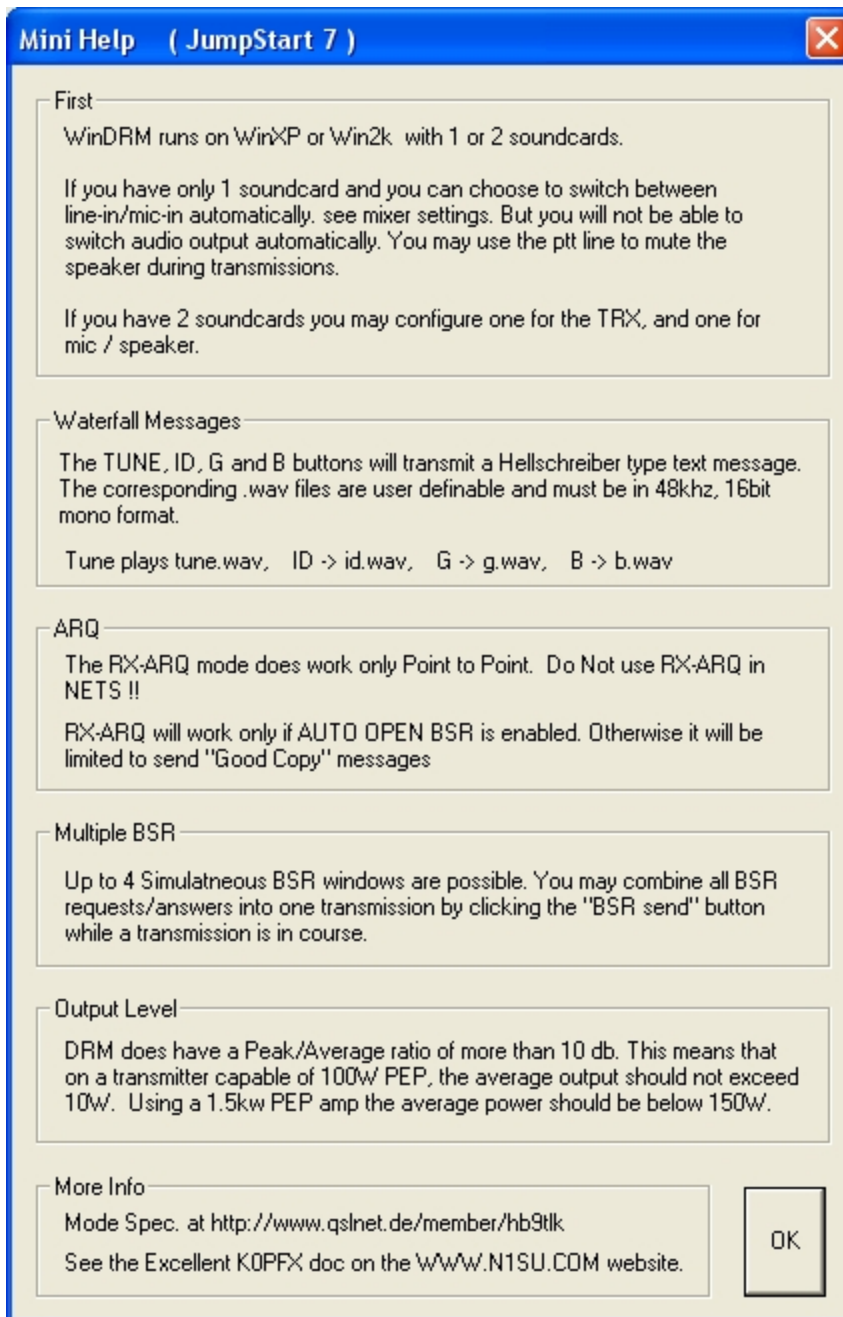

## About Help

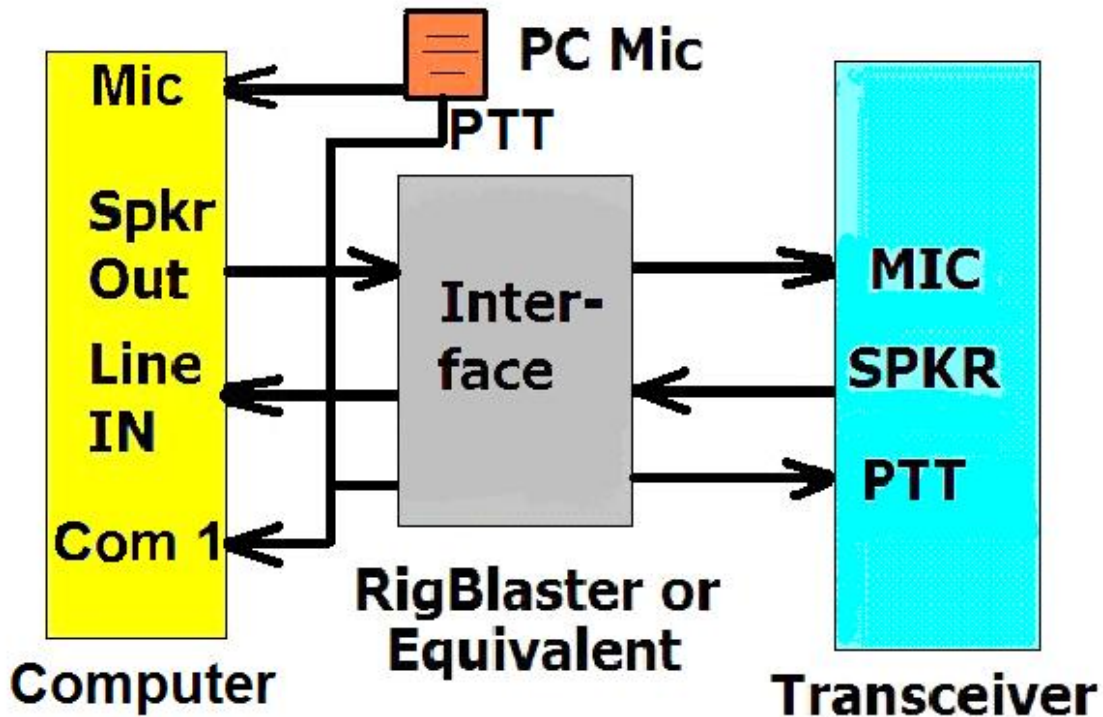

### Typical connections between PC, interface and radio

See "Setup PTT Port" info in this doc for more information on these connections. Any available com port 1 thru 8 may be used for all functions (PTT, Spacebar PTT, Remote PTT and Transceiver Speaker Mute).

**Further DRM technical info and software** may be found at: <http://www.drmrx.org/>, (DREAM 1.10.6cvs or later) and [www.drmradio.co.uk](http://www.drmradio.co.uk)

---

*updated 23-Jul-2008*  
 © copyright 2005-2008 by Mel Whitten, KØPFX – [mel@melwhitten.com](mailto:mel@melwhitten.com)