

## EIGHT DARLINGTON ARRAYS

- EIGHT DARLINGTONS WITH COMMON EMITTERS
- OUTPUT CURRENT TO 500 mA
- OUTPUT VOLTAGE TO 50 V
- INTEGRAL SUPPRESSION DIODES
- VERSIONS FOR ALL POPULAR LOGIC FAMILIES
- OUTPUT CAN BE PARALLELED
- INPUTS PINNED OPPOSITE OUTPUTS TO SIMPLIFY BOARD LAYOUT

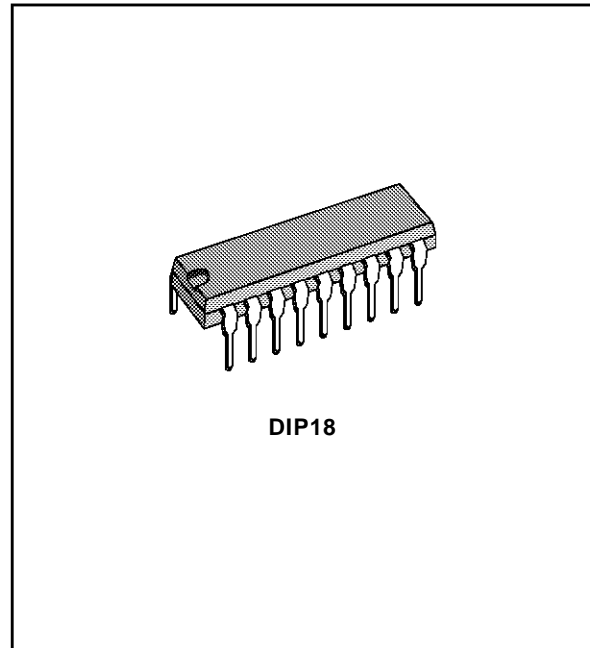

### DESCRIPTION

The ULN2801A-ULN2805A each contain eight darlington transistors with common emitters and integral suppression diodes for inductive loads. Each darlington features a peak load current rating of 600mA (500mA continuous) and can withstand at least 50V in the off state. Outputs may be paralleled for higher current capability.

Five versions are available to simplify interfacing to standard logic families : the ULN2801A is designed for general purpose applications with a current limit resistor ; the ULN2802A has a 10.5kΩ input resistor and zener for 14-25V PMOS ; the ULN2803A has a 2.7kΩ input resistor for 5V TTL and CMOS ; the ULN2804A has a 10.5kΩ input resistor for 6-15V CMOS and the ULN2805A is designed to sink a minimum of 350mA for standard and Schottky TTL where higher output current is required.

All types are supplied in a 18-lead plastic DIP with a copper lead from and feature the convenient input-opposite-output pinout to simplify board layout.

### PIN CONNECTION (top view)

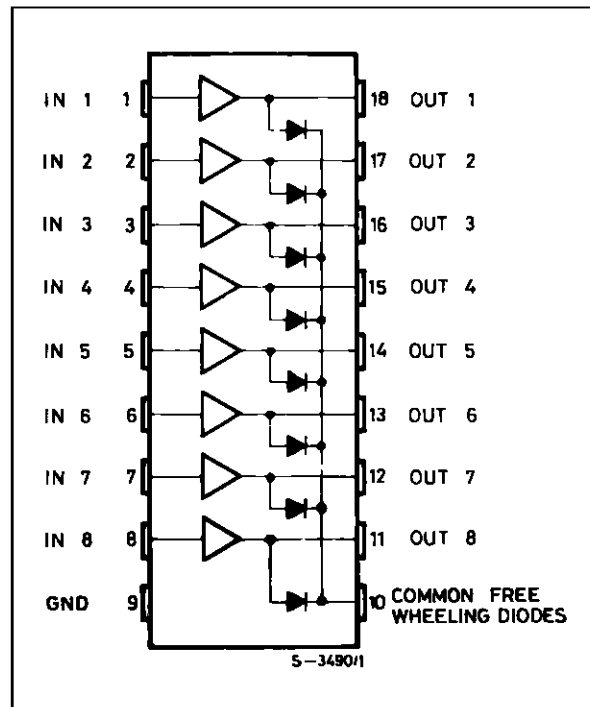

**ULN2801A - ULN2802A - ULN2803A - ULN2804A - ULN2805A**

**SCHEMATIC DIAGRAM AND ORDER CODES**

For ULN2801A (each driver for PMOS-CMOS)

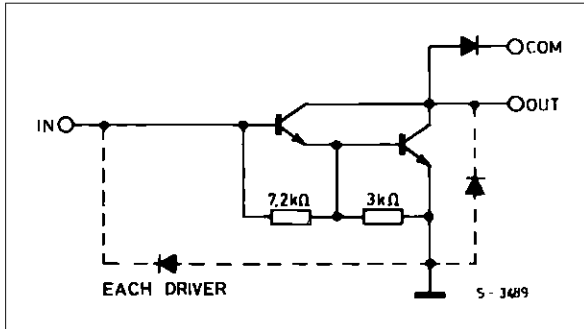

For ULN2802A (each driver for 14-15 V PMOS)

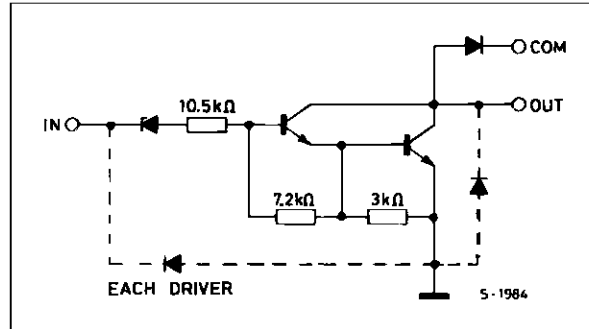

For ULN2803A (each driver for 5 V, TTL/CMOS)

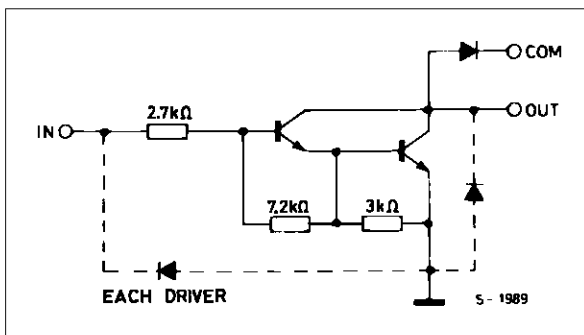

For ULN2804A (each driver for 6-15 V CMOS/PMOS)

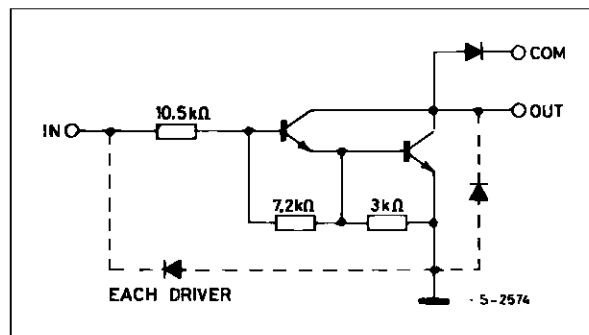

For ULN2805A (each driver for high out TTL)

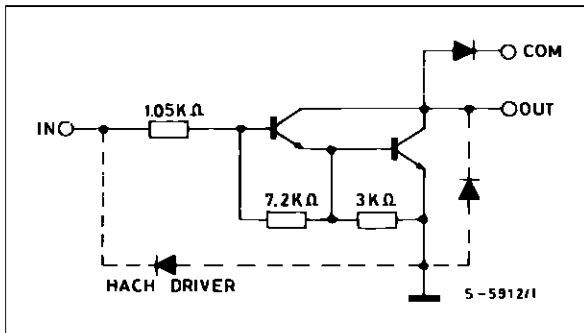

## ULN2801A - ULN2802A - ULN2803A - ULN2804A - ULN2805A

### ABSOLUTE MAXIMUM RATINGS

Symbol	Parameter	Value	Unit
$V_o$	Output Voltage	50	V
$V_i$	Input Voltage for ULN2802A, UL2803A, ULN2804A for ULN2805A	30 15	V
$I_C$	Continuous Collector Current	500	mA
$I_B$	Continuous Base Current	25	mA
$P_{tot}$	Power Dissipation (one Darlington pair) (total package)	1.0 2.25	W
$T_{amb}$	Operating Ambient Temperature Range	- 20 to 85	°C
$T_{stg}$	Storage Temperature Range	- 55 to 150	°C

### THERMAL DATA

Symbol	Parameter	Value	Unit
$R_{th\ j-amb}$	Thermal Resistance Junction-ambient Max.	55	°C/W

### ELECTRICAL CHARACTERISTICS ( $T_{amb} = 25^\circ\text{C}$ unless otherwise specified)

Symbol	Parameter	Test Conditions	Min.	Typ.	Max.	Unit	Fig.
$I_{CEX}$	Output Leakage Current	$V_{CE} = 50V$ $T_{amb} = 70^\circ\text{C}$ , $V_{CE} = 50V$			50 100	$\mu\text{A}$ $\mu\text{A}$	1a 1a
		$T_{amb} = 70^\circ\text{C}$ for ULN2802A $V_{CE} = 50V$ , $V_i = 6V$ for ULN2804A $V_{CE} = 50V$ , $V_i = 1V$			500	$\mu\text{A}$	1b
					500	$\mu\text{A}$	1b
$V_{CE(sat)}$	Collector-emitter Saturation Voltage	$I_C = 100\text{mA}$ , $I_B = 250\mu\text{A}$ $I_C = 200\text{mA}$ , $I_B = 350\mu\text{A}$ $I_C = 350\text{mA}$ , $I_B = 500\mu\text{A}$		0.9 1.1 1.3	1.1 1.3 1.6	V V V	2
$I_{i(on)}$	Input Current	for ULN2802A $V_i = 17V$		0.82	1.25	mA	3
		for ULN2803A $V_i = 3.85V$		0.93	1.35	mA	
		for ULN2804A $V_i = 5V$		0.35	0.5	mA	
		for ULN2805A $V_i = 12V$ $V_i = 3V$		1 1.5	1.45 2.4	mA mA	
$I_{i(off)}$	Input Current	$T_{amb} = 70^\circ\text{C}$ , $I_C = 500\mu\text{A}$	50	65		$\mu\text{A}$	4
$V_{i(on)}$	Input Voltage	$V_{CE} = 2V$ for ULN2802A $I_C = 300\text{mA}$			13	V	5
		for ULN2803A $I_C = 200\text{mA}$			2.4	V	
		$I_C = 250\text{mA}$			2.7	V	
		$I_C = 300\text{mA}$			3	V	
		for ULN2804A $I_C = 125\text{mA}$			5	V	
		$I_C = 200\text{mA}$			6	V	
		$I_C = 275\text{mA}$			7	V	
		$I_C = 350\text{mA}$			8	V	
		for ULN2805A $I_C = 350\text{mA}$			2.4	V	
$h_{FE}$	DC Forward Current Gain	for ULN2801A $V_{CE} = 2V$ , $I_C = 350\text{mA}$	1000			-	2
$C_i$	Input Capacitance			15	25	pF	-
$t_{PLH}$	Turn-on Delay Time	$0.5 V_i$ to $0.5 V_o$		0.25	1	$\mu\text{s}$	-
$t_{PHL}$	Turn-off Delay Time	$0.5 V_i$ to $0.5 V_o$		0.25	1	$\mu\text{s}$	-
$I_R$	Clamp Diode Leakage Current	$V_R = 50V$ $T_{amb} = 70^\circ\text{C}$ , $V_R = 50V$			50 100	$\mu\text{A}$ $\mu\text{A}$	6 6
$V_F$	Clamp Diode Forward Voltage	$I_F = 350\text{mA}$		1.7	2	V	7

TEST CIRCUITS

Figure 1a.

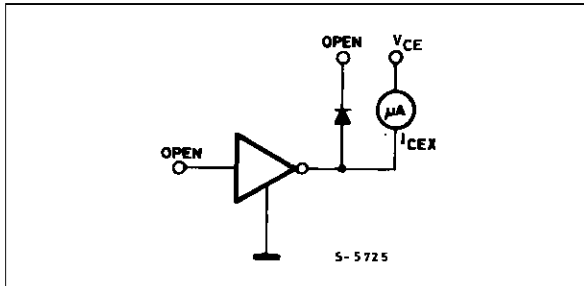

Figure 1b.

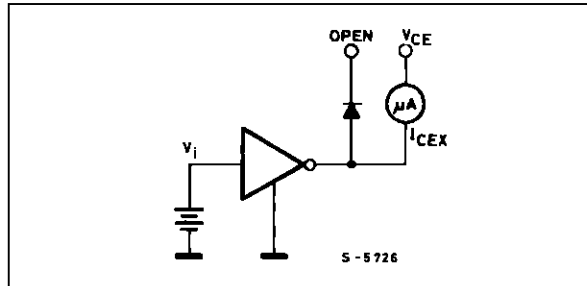

Figure 2.

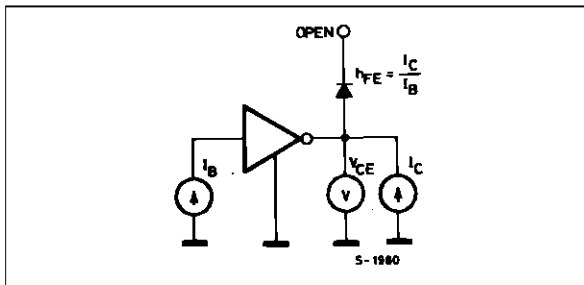

Figure 3.

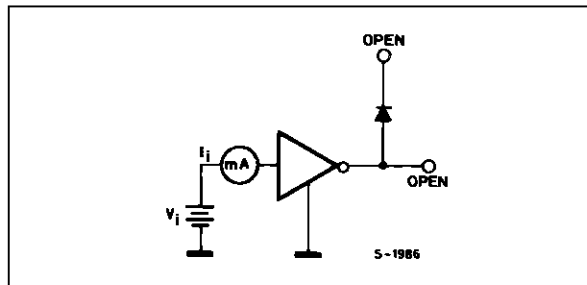

Figure 4.

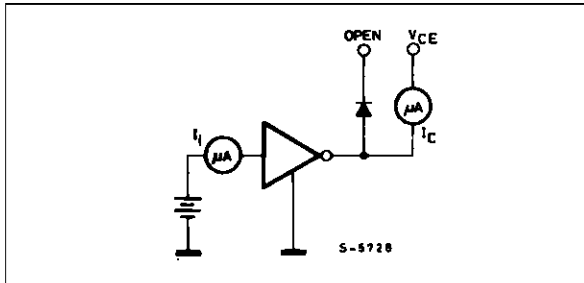

Figure 5.

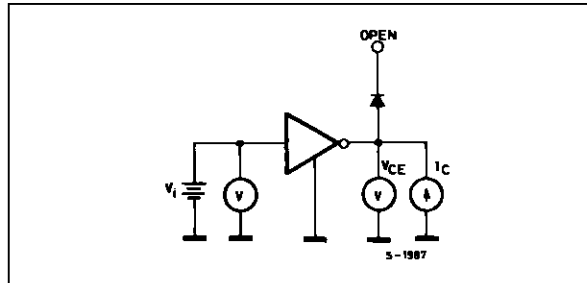

Figure 6.

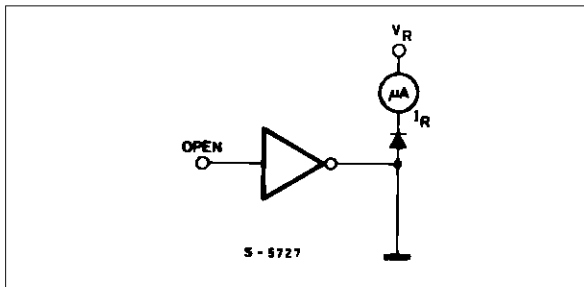
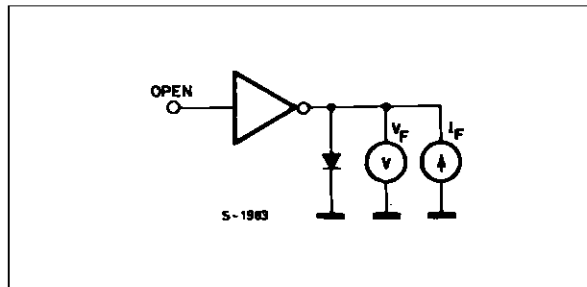
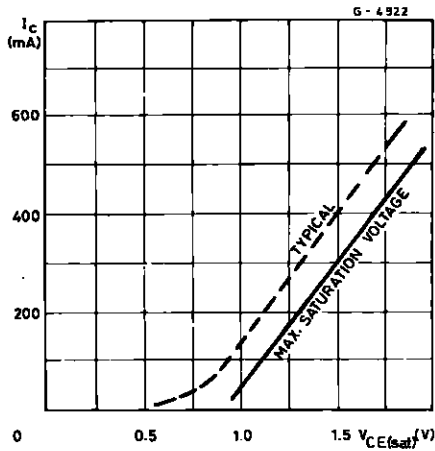

Figure 7.



**Figure 8 :** Collector Current as a Function of Saturation Voltage.



**Figure 9 :** Collector Current as a Function of Input Current.

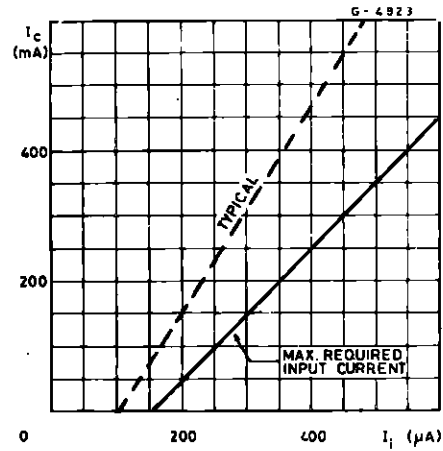

**Figure 10 :** Allowable Average Power Dissipation as a Function of Ambient Temperature.

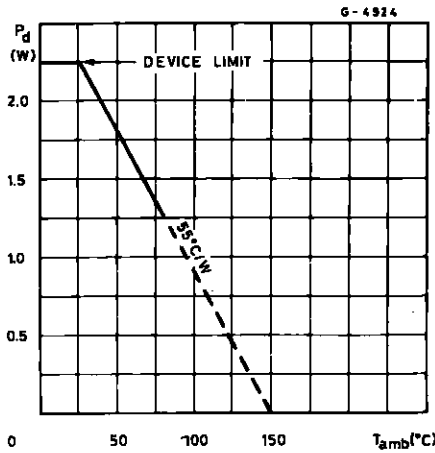

**Figure 11 :** Peak Collector Current as a Function of Duty Cycle.

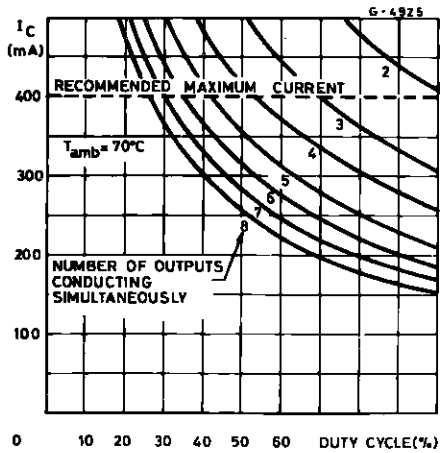

**Figure 12 :** Peak Collector Current as a Function of Duty.

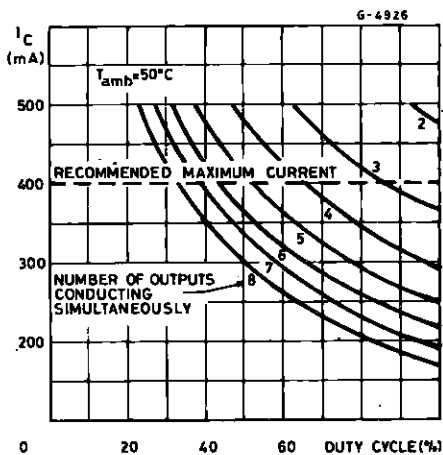

**Figure 13 :** Input Current as a Function of Input Voltage (for ULN2802A).

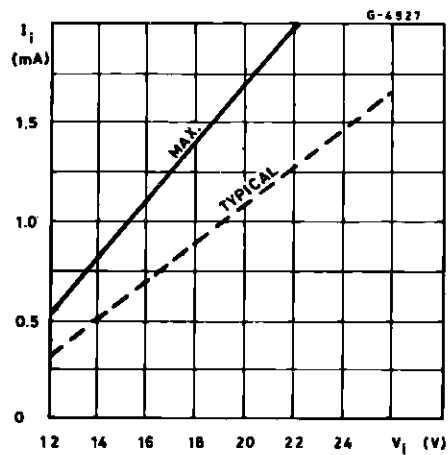

ULN2801A - ULN2802A - ULN2803A - ULN2804A - ULN2805A

Figure 14 : Input Current as a Function of Input Voltage (for ULN2804A)

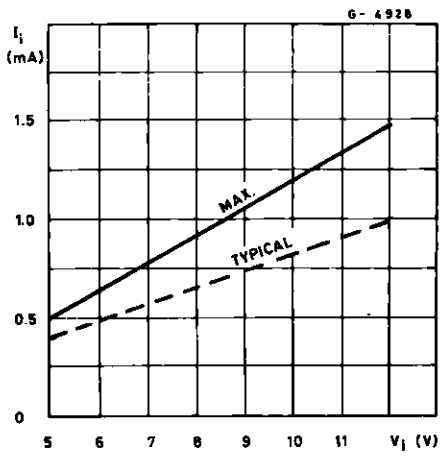

Figure 15 : Input Current as a Function of Input Voltage (for ULN2803A)

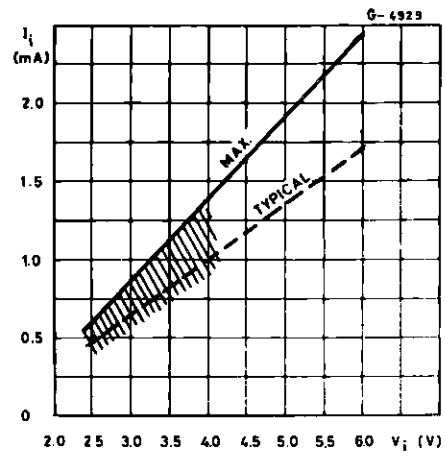
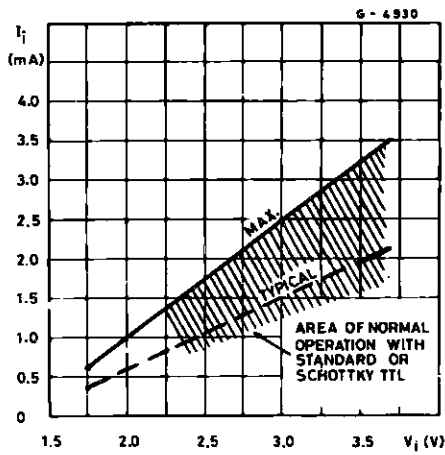

Figure 16 : Input Current as a Function of Input Voltage (for ULN2805A)



ULN2801A - ULN2802A - ULN2803A - ULN2804A - ULN2805A

DIP18 PACKAGE MECHANICAL DATA

DIM.	mm			inch		
	MIN.	TYP.	MAX.	MIN.	TYP.	MAX.
a1	0.254			0.010		
B	1.39		1.65	0.055		0.065
b		0.46			0.018	
b1		0.25			0.010	
D			23.24			0.915
E		8.5			0.335	
e		2.54			0.100	
e3		20.32			0.800	
F			7.1			0.280
l			3.93			0.155
L		3.3			0.130	
Z		1.27	1.59		0.050	0.063

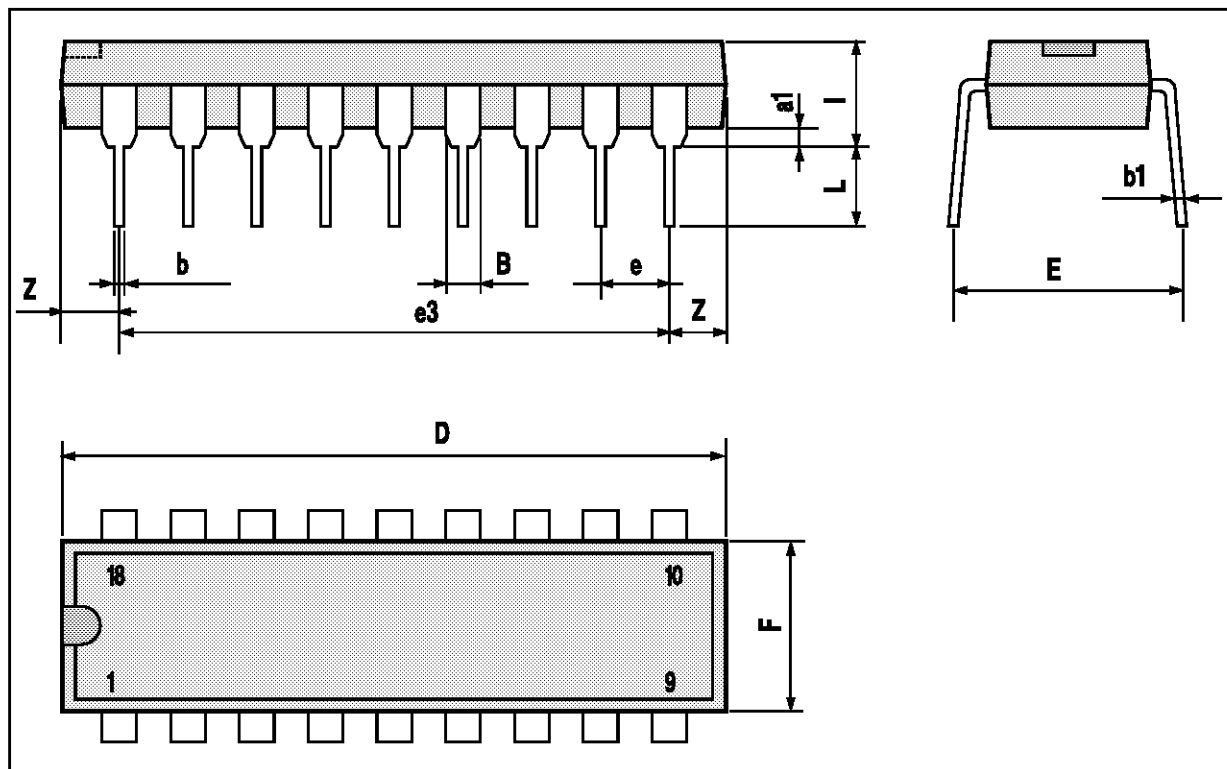

Information furnished is believed to be accurate and reliable. However, SGS-THOMSON Microelectronics assumes no responsibility for the consequences of use of such information nor for any infringement of patents or other rights of third parties which may result from its use. No license is granted by implication or otherwise under any patent or patent rights of SGS-THOMSON Microelectronics. Specifications mentioned in this publication are subject to change without notice. This publication supersedes and replaces all information previously supplied. SGS-THOMSON Microelectronics products are not authorized for use as critical components in life support devices or systems without express written approval of SGS-THOMSON Microelectronics.

© 1994 SGS-THOMSON Microelectronics - All Rights Reserved

SGS-THOMSON Microelectronics GROUP OF COMPANIES  
Australia - Brazil - France - Germany - Hong Kong - Italy - Japan - Korea - Malaysia - Malta - Morocco - The Netherlands - Singapore -  
Spain - Sweden - Switzerland - Taiwan - Thailand - United Kingdom - U.S.A.