

T-31-25  
**BF 960**

**N-Channel Dual Gate MOS-Fieldeffect Tetrode · Depletion Mode**

**Applications:** Input- and Mixerstages especially for UHF TV-tuners up to 900 MHz

**Features:**

- Integrated Gate protection diodes
- High cross modulation performance
- Low noise figure
- High AGC-range
- Low feedback capacitance
- Low input capacitance

**Dimensions in mm**

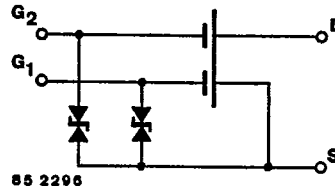
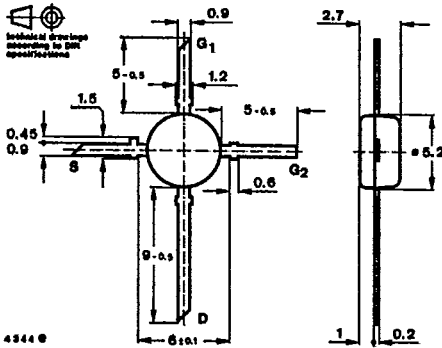

Case  
50 B 4 DIN 41 867  
JEDEC TO 50  
Weight max. 0.1 g

**Absolute maximum ratings**

Drain Source Voltage	$V_{DS}$	20	V
Drain current	$I_D$	30	mA
Gate 1/Gate 2-Source peak current	$\pm I_{G1/2SM}$	10	mA
Total power dissipation $T_{amb} = 60^\circ C$	$P_{tot}$	200	mW
Channel temperature	$T_C$	150	$^\circ C$
Storage temperature range	$T_{stg}$	-55 ... +150	$^\circ C$

**Thermal resistance**

	Min.	Typ.	Max.
Channel ambient mounted on pc-board one side Cu 35 $\mu m$ thickness 40 x 25 x 1.5 mm <sup>3</sup>			450 K/W

T1.2/330.1183 E2

**3523 6-04**

## BF 960

T-31-25

DC characteristics		Min.	Typ.	Max.
$T_{amb} = 25\text{ }^{\circ}\text{C}$ , unless otherwise specified				
Drain-source breakdown voltage				
$I_D = 10\text{ }\mu\text{A}$ , $-V_{G1S} = -V_{G2S} = 4\text{ V}$	$V_{(BR)DS}$	20		V
Gate 1-Source breakdown voltage				
$\pm I_{G1S} = 10\text{ mA}$ , $V_{G2S} = V_{DS} = 0$	$\pm V_{(BR)G1SS}$	6	20	V
Gate 2-Source breakdown voltage				
$\pm I_{G2S} = 10\text{ mA}$ , $V_{G1S} = V_{DS} = 0$	$\pm V_{(BR)G2SS}$	6	20	V
Gate 1-Source cut-off current				
$\pm V_{G1S} = 5\text{ V}$ , $V_{G2S} = V_{DS} = 0$	$I_{G1SS}$		50	nA
Gate 2-Source cut-off current				
$\pm V_{G2S} = 5\text{ V}$ , $V_{G1S} = V_{DS} = 0$	$I_{G2SS}$		50	nA
Drain current				
$V_{DS} = 15\text{ V}$ , $V_{G1S} = 0$ , $V_{G2S} = 4\text{ V}$	$I_{DSS}$	2	20	mA
Gate 1-Source cut-off voltage				
$V_{DS} = 15\text{ V}$ , $V_{G2S} = 4\text{ V}$ , $I_D = 20\text{ }\mu\text{A}$	$-V_{G1S(OFF)}$		2.7	V
Gate 2-Source cut-off voltage				
$V_{DS} = 15\text{ V}$ , $V_{G1S} = 0\text{ V}$ , $I_D = 20\text{ }\mu\text{A}$	$-V_{G2S(OFF)}$		2.7	V
<b>AC characteristics</b>				
$V_{DS} = 15\text{ V}$ , $I_D = 7\text{ mA}$ , $V_{G2S} = 4\text{ V}$ , $f = 1\text{ MHz}$ , $T_{amb} = 25\text{ }^{\circ}\text{C}$ , unless otherwise specified				
Forward transadmittance	$ y_{21} $	10	13	mS
Gate 1-Input capacitance	$C_{ISSg1}$		1.8	pF
Gate 2-Input capacitance				
$V_{G1S} = 0$ , $V_{G2S} = 4\text{ V}$	$C_{ISSg2}$		1.0	pF
Feedback capacitance	$C_{rSS}^{1)}$		25	fF
Output capacitance	$C_{oSS}$		0.8	pF
Power gain				
$V_{DS} = 15\text{ V}$ , $I_D = 7\text{ mA}$ , $V_{G2S} = 4\text{ V}$ , $g_G = 2\text{ mS}$ , $g_L = 5\text{ mS}$ , $f = 200\text{ MHz}$	$G_{ps}$		23	dB
$g_L = 1\text{ mS}$ , $f = 800\text{ MHz}$	$G_{ps}$		16.5	dB
Noise figure				
$g_G = 2\text{ mS}$ , $f = 800\text{ MHz}$	$F$		2.2	3 dB
$V_{DS} = 15\text{ V}$ , $I_D = 7\text{ mA}$ , $V_{G2S} = 4\text{ V}$ , $V_{G1S} = 0$				

<sup>1)</sup>  $G_2$  and S grounded

T-31-25

BF 960

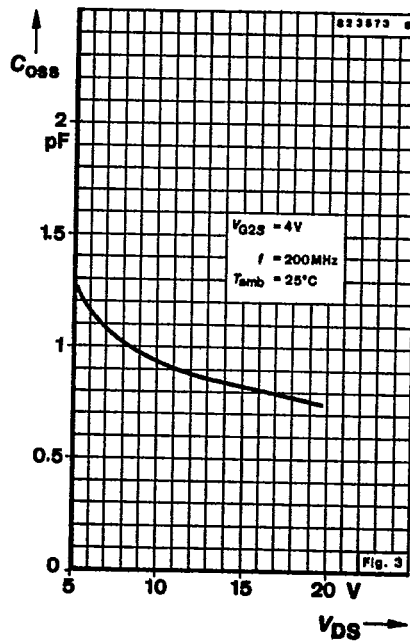
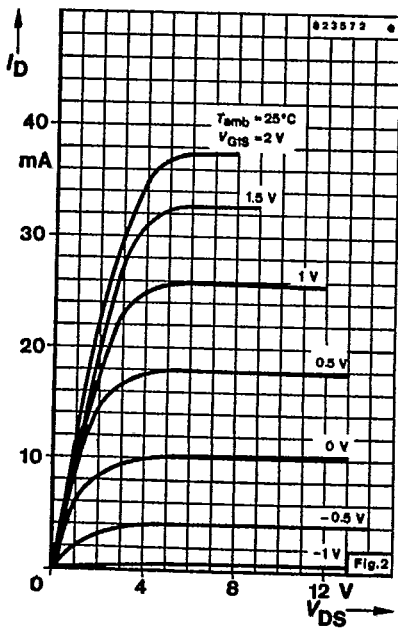
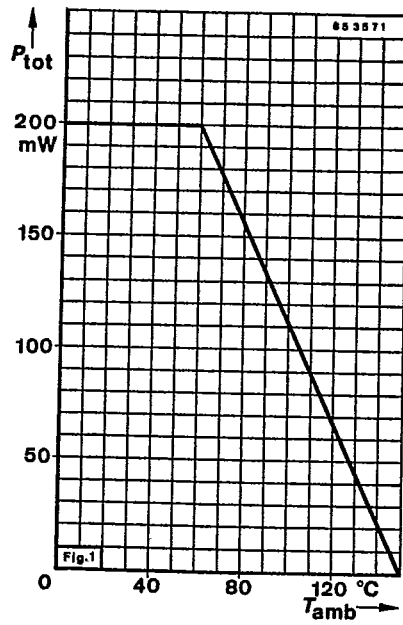

BF 960

T-31-25

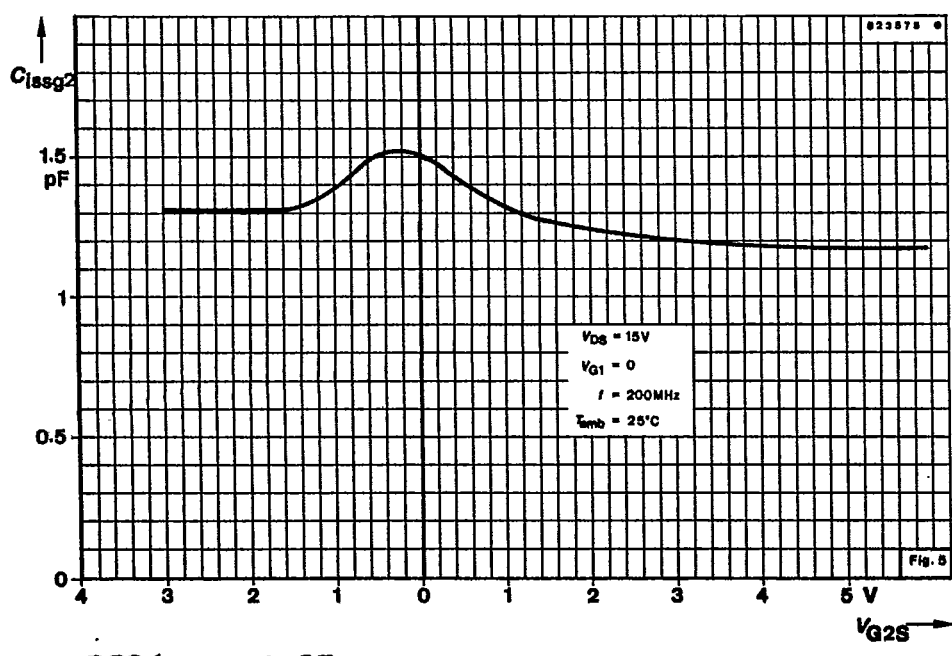
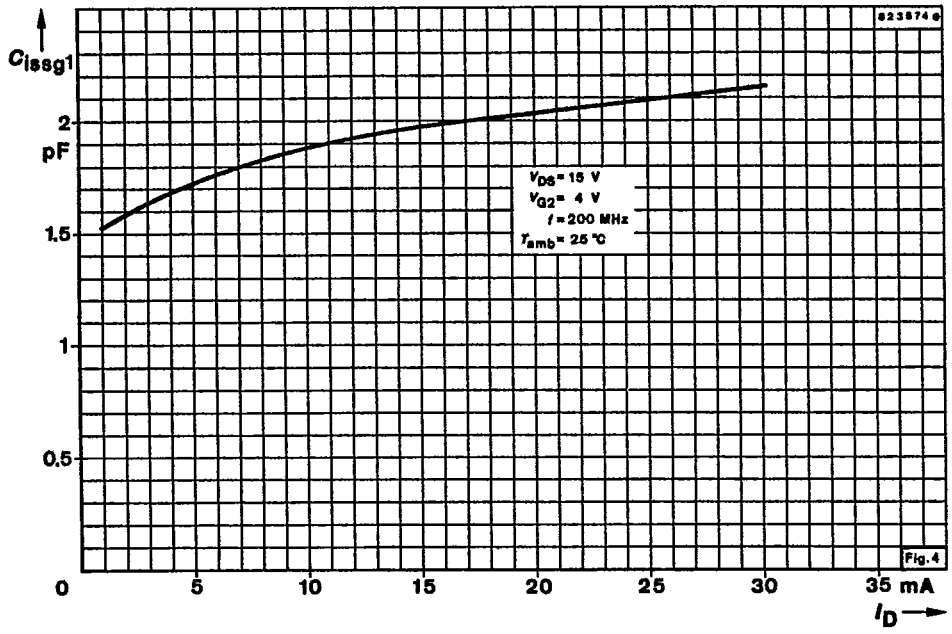

T-31-25 BF 960

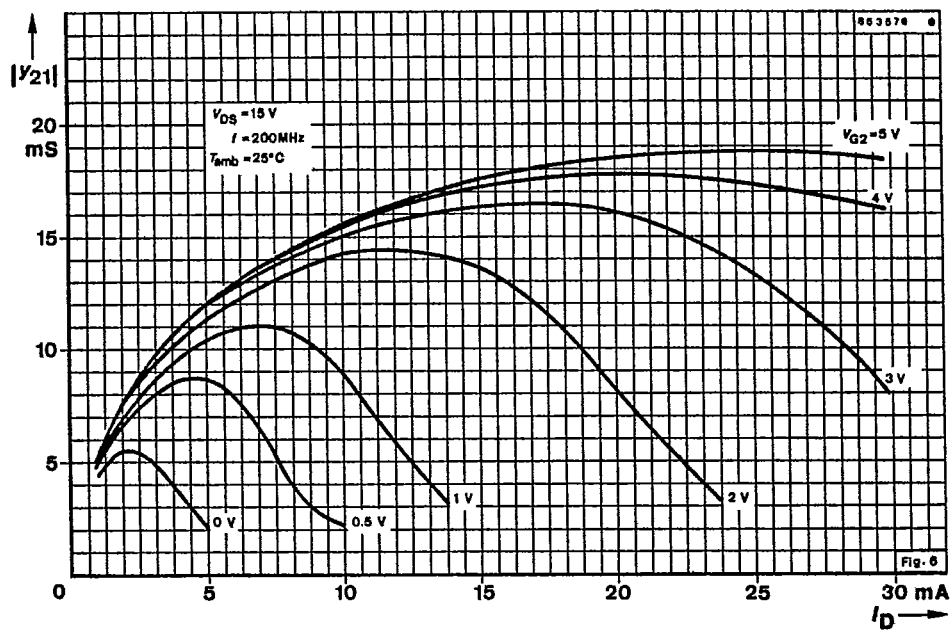

Fig. 6

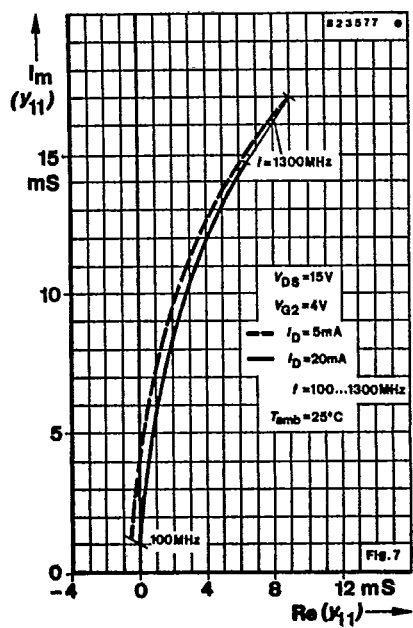

Fig. 7

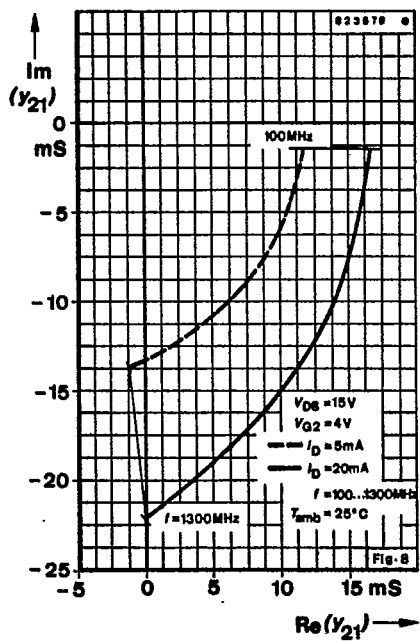
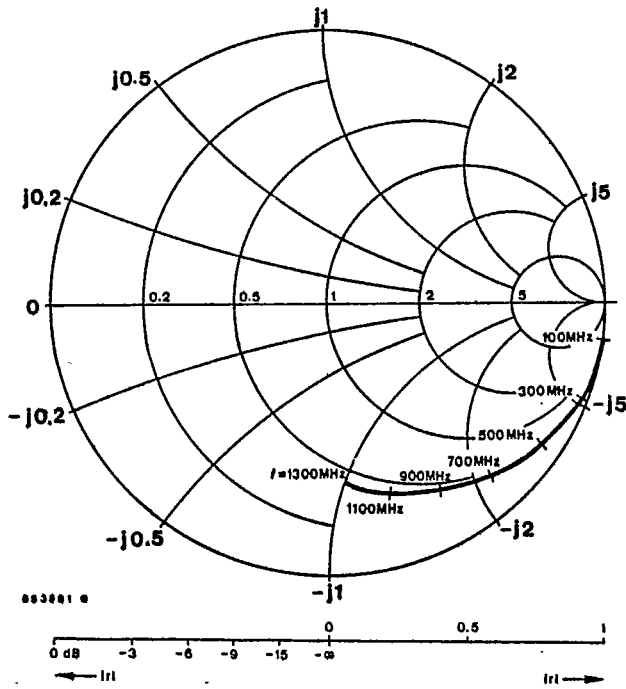
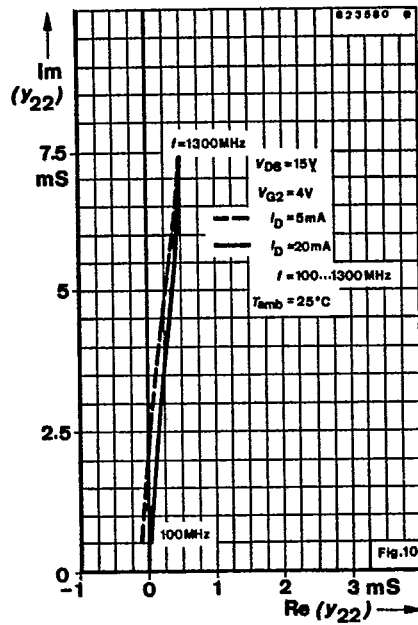
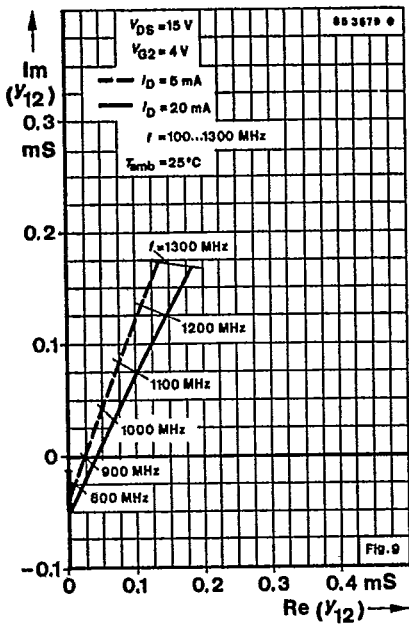

Fig. 8

BF 960

7-31-25



**S<sub>11</sub>**  
 $I_D = 10\text{mA}$   
 $V_{DS} = 15\text{V}$   
 $V_{G2} = 4\text{V}$   
 $Z_0 = 50\Omega$   
 $f = 100 \dots 1300\text{MHz}$   
 $T_{amb} = 25^\circ\text{C}$

Fig. 11

7-31-25

BF 960

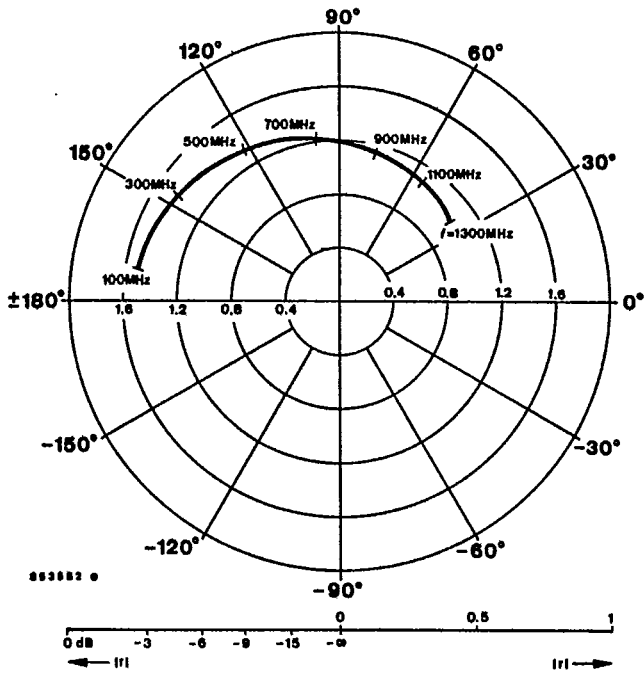

**S<sub>21</sub>**  
 $Z_o = 50\Omega$   
 $V_{DS} = 15V$   
 $V_{G2} = 4V$   
 $I_D = 10mA$   
 $f = 100...1300MHz$   
 $T_{amb} = 25^\circ C$

Fig.12

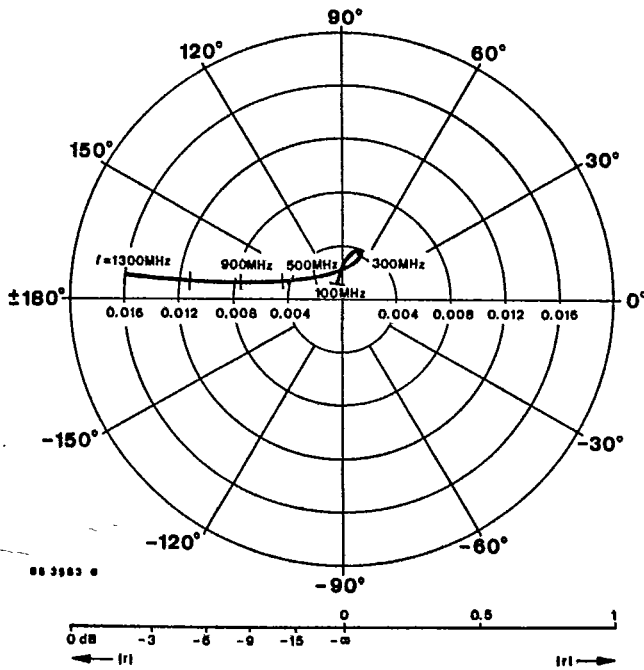

**S<sub>12</sub>**  
 $Z_o = 50\Omega$   
 $V_{DS} = 15V$   
 $V_{G2} = 4V$   
 $I_D = 10mA$   
 $f = 100...1300MHz$   
 $T_{amb} = 25^\circ C$

Fig.13

T-31-25

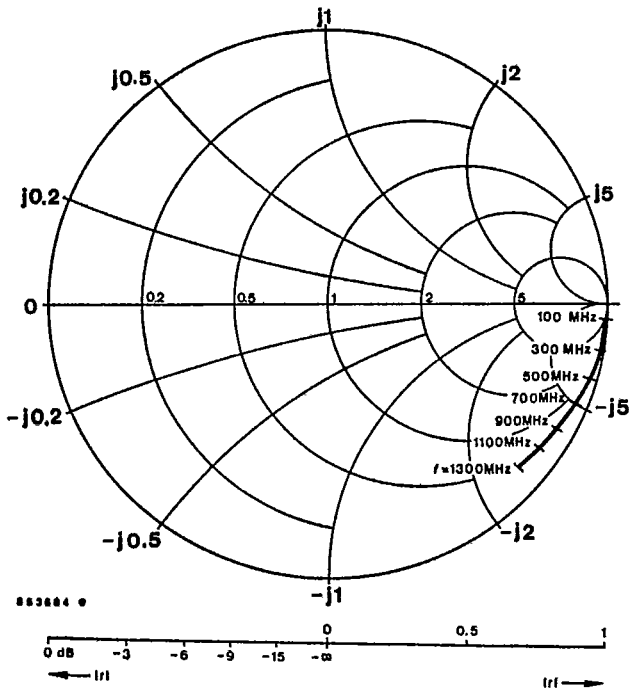

**S<sub>22</sub>**  
 $I_D = 3 \dots 10 \text{ mA}$   
 $V_{DS} = 15 \text{ V}$   
 $V_{G2} = 4 \text{ V}$   
 $Z_0 = 50 \Omega$   
 $f = 100 \dots 1300 \text{ MHz}$   
 $T_{amb} = 25^\circ \text{ C}$

Fig.14



7. Taping and Reeling

T-91-20

7.1. Taping of TO-92 Transistors

Standard reeling: Taped on reel, reeled together with a paper film.

7.1.1. Order Numbers

Add the taping-code to the order number.

Example:

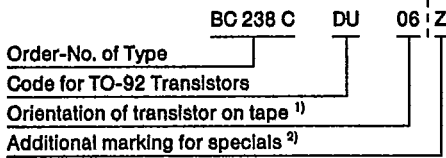

- <sup>1)</sup> 06 = View on flat side of transistor, view on gummed tape
- 05 = View on round side of transistor, view on gummed tape

- <sup>2)</sup> Additional marking "0": taping without paper film
- Additional marking "Z": Zigzag folded tape in special box. Marking for orientation of transistor not necessary, because box can be opened on top or bottom

Example for order No.: BC 237 C DU Z

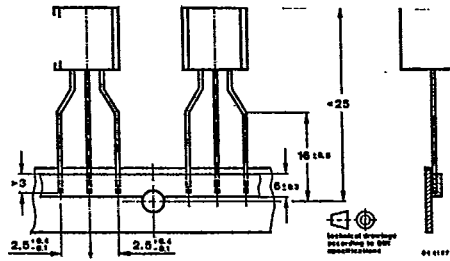

Fig. 7.3 Dimensions of tape in mm

7.1.2 Quantity of devices

- 1 000 devices per reel
- 2 000 devices per folded tape in special box.

7.2. Taped transistors in SOT 23 and SOT 143 case

7.2.1. Designation

a) Standard taping

Designation is attached with code GS 08 in case of standard taping. Example for normal version transistors as standard taped: BF 569-GS 08.

Example for R-version transistors as standard taped: BF 569 R-GS 08.

In case of standard taping, the transistor orientation on the tape is shown in Fig. 7.4 and Fig. 7.5.

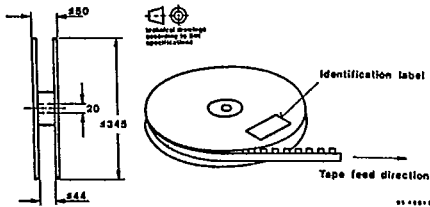

Fig. 7.1. Dimensions of reel in mm

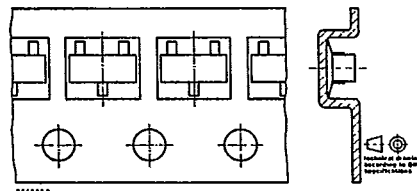

Fig. 7.4 Standard taped SOT 23

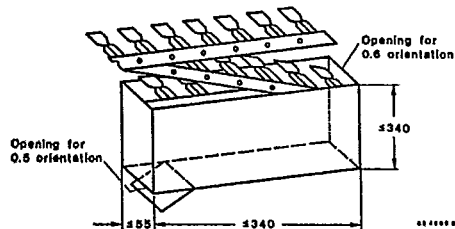

Fig. 7.2. Dimension of box for Zigzag folding in mm

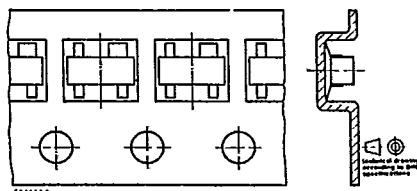

Fig. 7.5. Standard taped SOT 143

T-91-20

b) Reverse taping

Designation is attached with code GS07 in case of reverse taping. Example for normal version transistors as reverse taped: BF 569-GS 07.

Example for R-version transistors as reverse taping: BF 569 R-GS 07.

In case of reverse taping, the transistor orientation on the tape is shown in Fig. 7.6.

Regarding MOS-FET and MES-FET devices, reverse taping is at present not available.

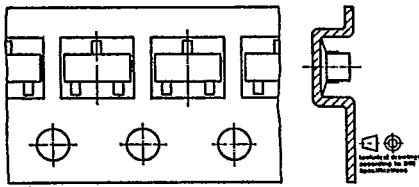

Fig. 7.6 Reverse taped SOT 23

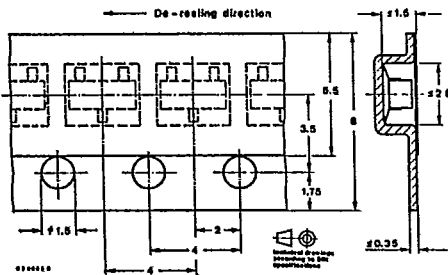

Fig. 7.7 Dimensions of tape in mm

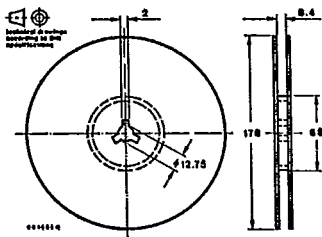

Fig. 7.8 Dimensions of reel in mm

7.2.2 Quantity of devices

3000 devices per reel