

MOTOROLA
SEMICONDUCTOR
TECHNICAL DATA

**OCTAL HIGH VOLTAGE, HIGH CURRENT
DARLINGTON TRANSISTOR ARRAYS**

The eight NPN Darlington connected transistors in this family of arrays are ideally suited for interfacing between low logic level digital circuitry (such as TTL, CMOS or PMOS/NMOS) and the higher current/voltage requirements of lamps, relays, printer hammers or other similar loads for a broad range of computer, industrial, and consumer applications. All devices feature open-collector outputs and free wheeling clamp diodes for transient suppression.

The ULN2801 is a general purpose device for use with CMOS, PMOS or TTL logic. The ULN2802 contains a zener diode and resistor in series with the input to limit input currents and assure compatibility with 14 to 25 volt PMOS logic. The ULN2803 is designed to be compatible with standard TTL families while the ULN2804 is optimized for 6 to 15 volt high level CMOS or PMOS.

7

ULN2801
ULN2802
ULN2803
ULN2804

**OCTAL
PERIPHERAL
DRIVER ARRAYS**

**SILICON MONOLITHIC
INTEGRATED CIRCUITS**

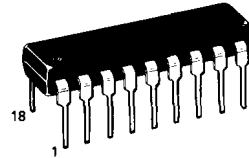

A SUFFIX
PLASTIC PACKAGE
CASE 707

MAXIMUM RATINGS ($T_A = 25^\circ\text{C}$ and rating apply to any one device in the package unless otherwise noted.)

Rating	Symbol	Value	Unit
Output Voltage	V_O	50	V
Input Voltage (Except ULN2801)	V_I	30	V
Collector Current — Continuous	I_C	500	mA
Base Current — Continuous	I_B	25	mA
Operating Ambient Temperature Range	T_A	0 to +70	$^\circ\text{C}$
Storage Temperature Range	T_{stg}	-55 to +150	$^\circ\text{C}$
Junction Temperature	T_J	125	$^\circ\text{C}$

$R_{\theta JA} = 55^\circ\text{C/W}$
Do not exceed maximum current limit per driver.

ORDERING INFORMATION

Device	Characteristics		
	Input Compatibility	$V_{CE(\text{Max})}/I_C(\text{Max})$	T_A
ULN2801A	General Purpose CMOS, PMOS	50 V/500 mA	0 to +70 $^\circ\text{C}$
ULN2802A	14–25 Volt PMOS		
ULN2803A	TTL, 5.0 V CMOS		
ULN2804A	6–15 V CMOS, PMOS		

PIN CONNECTIONS

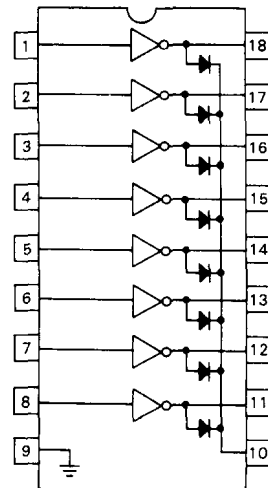

ULN2801, ULN2802, ULN2803, ULN2804

ELECTRICAL CHARACTERISTICS (T_A = 25°C unless otherwise noted)

Characteristic		Fig.	Symbol	Min	Typ	Max	Unit
Output Leakage Current (V _O = 50 V, T _A = +70°C) (V _O = 50 V, T _A = +25°C) (V _O = 50 V, T _A = +70°C, V _I = 6.0 V) (V _O = 50 V, T _A = +70°C, V _I = 1.0 V)	All Types All Types ULN2802 ULN2804	1	I _{CEX}	—	—	100 50 500 500	μA
Collector-Emitter Saturation Voltage (I _C = 350 mA, I _B = 500 μA) (I _C = 200 mA, I _B = 350 μA) (I _C = 100 mA, I _B = 250 μA)	All Types All Types All Types	2	V _{CE(sat)}	—	1.1 0.95 0.85	1.6 1.3 1.1	V
Input Current — On Condition (V _I = 17 V) (V _I = 3.85 V) (V _I = 5.0 V) (V _I = 12 V)	ULN2802 ULN2803 ULN2804 ULN2804	4	I _{I(on)}	—	0.82 0.93 0.35 1.0	1.25 1.35 0.5 1.45	mA
Input Voltage — On Condition (V _{CE} = 2.0 V, I _C = 300 mA) (V _{CE} = 2.0 V, I _C = 200 mA) (V _{CE} = 2.0 V, I _C = 250 mA) (V _{CE} = 2.0 V, I _C = 300 mA) (V _{CE} = 2.0 V, I _C = 125 mA) (V _{CE} = 2.0 V, I _C = 200 mA) (V _{CE} = 2.0 V, I _C = 275 mA) (V _{CE} = 2.0 V, I _C = 350 mA)	ULN2802 ULN2803 ULN2803 ULN2803 ULN2804 ULN2804 ULN2804 ULN2804	5	V _{I(on)}	—	—	13 2.4 2.7 3.0 5.0 6.0 7.0 8.0	V
Input Current — Off Condition (I _C = 500 μA, T _A = +70°C)	All Types	3	I _{I(off)}	50	100	—	μA
DC Current Gain (V _{CE} = 2.0 V, I _C = 350 mA)	ULN2801	2	h _{FE}	1000	—	—	—
Input Capacitance			C _I	—	15	25	pF
Turn-On Delay Time (50% E _I to 50% E _O)			t _{on}	—	0.25	1.0	μs
Turn-Off Delay Time (50% E _I to 50% E _O)			t _{off}	—	0.25	1.0	μs
Clamp Diode Leakage Current (V _R = 50 V)	T _A = +25°C T _A = +70°C	6	I _R	—	—	50 100	μA
Clamp Diode Forward Voltage (I _F = 350 mA)		7	V _F	—	1.5	2.0	V

7

ULN2801, ULN2802, ULN2803, ULN2804

TEST FIGURES

(SEE FIGURE NUMBERS IN ELECTRICAL CHARACTERISTICS TABLES)

FIGURE 1

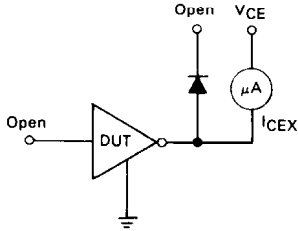

FIGURE 2

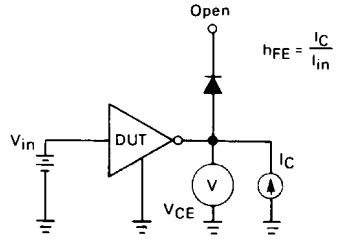

FIGURE 3

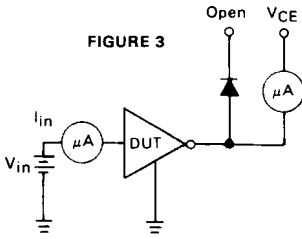

FIGURE 4

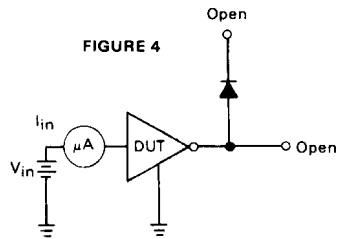

FIGURE 5

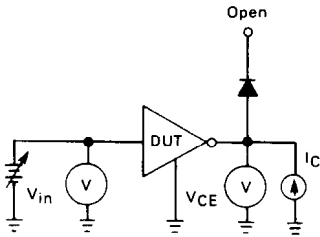

FIGURE 7

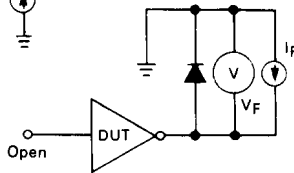
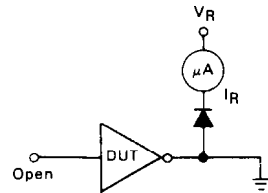

FIGURE 6



ULN2801, ULN2802, ULN2803, ULN2804

TYPICAL CHARACTERISTIC CURVES — $T_A = 25^\circ\text{C}$
(unless otherwise noted)

OUTPUT CHARACTERISTICS

FIGURE 8 — OUTPUT CURRENT versus SATURATION VOLTAGE

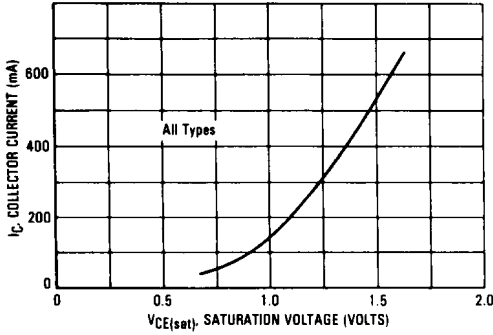
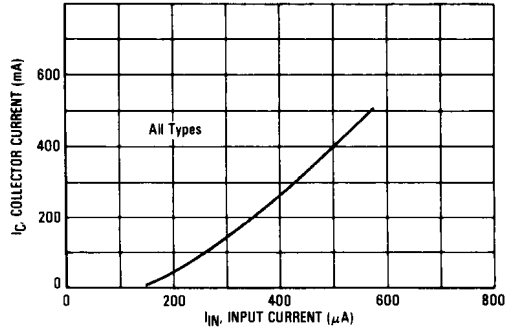

FIGURE 9 — OUTPUT CURRENT versus INPUT CURRENT



INPUT CHARACTERISTICS

FIGURE 10 — ULN2802 INPUT CURRENT versus INPUT VOLTAGE

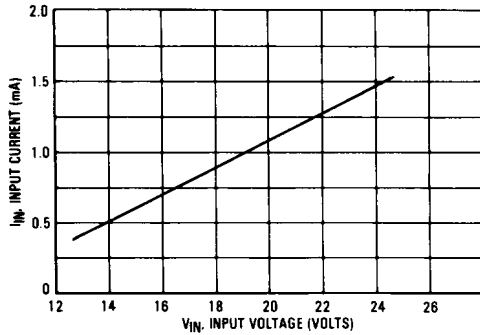

FIGURE 11 — ULN2803 INPUT CURRENT versus INPUT VOLTAGE

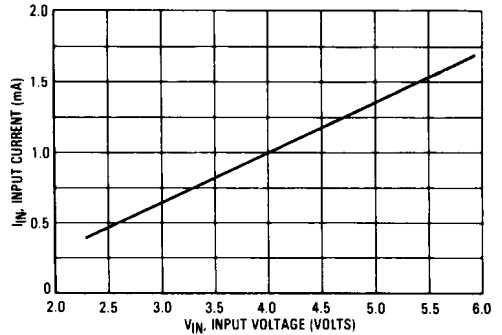
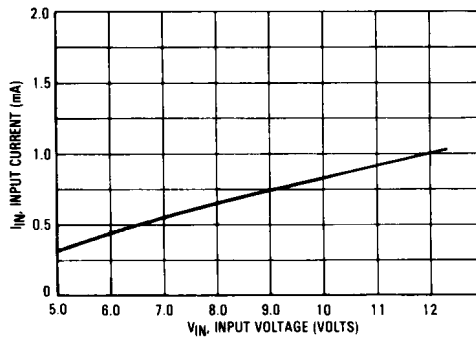
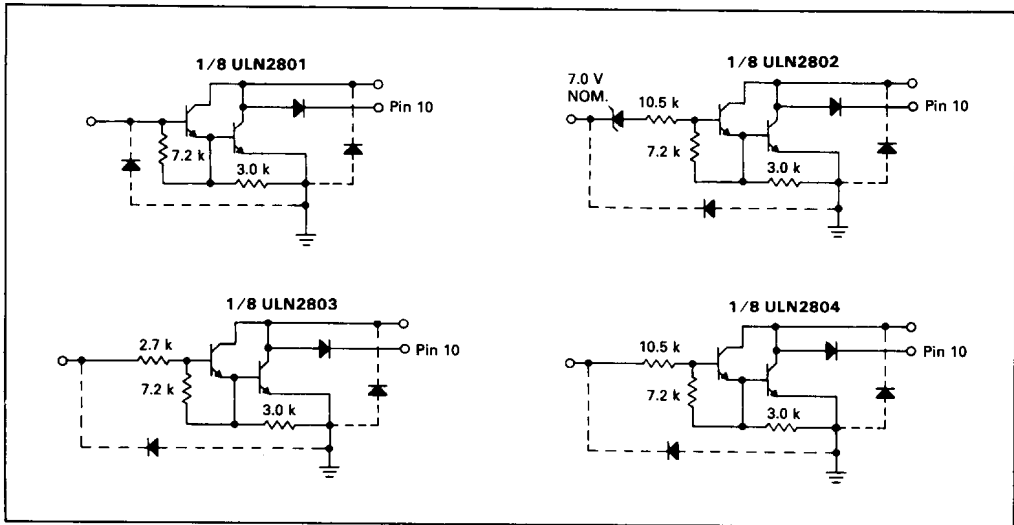

FIGURE 12 — ULN2804 INPUT CURRENT versus INPUT VOLTAGE



ULN2801, ULN2802, ULN2803, ULN2804

REPRESENTATIVE CIRCUIT SCHEMATICS



7