

The RF Line

NPN Silicon

RF Power Transistor

Designed for 26 Volt UHF large-signal, common emitter, Class AB linear amplifier applications in industrial and commercial FM/AM equipment operating in the range 800–960 MHz.

- Specified 26 Volt, 900 MHz Characteristics
 - Output Power = 150 Watts (PEP)
 - Minimum Gain = 8.0 dB @ 900 MHz, Class AB
 - Minimum Efficiency = 35% @ 900 MHz, 150 Watts (PEP)
 - Maximum Intermodulation Distortion –28 dBc @ 150 Watts (PEP)
- Characterized with Series Equivalent Large-Signal Parameters from 800 to 960 MHz
- Silicon Nitride Passivated
- 100% Tested for Load Mismatch Stress at all Phase Angles with 5:1 VSWR @ 26 Vdc, and Rated Output Power
- Gold Metallized, Emitter Ballasted for Long Life and Resistance to Metal Migration
- Circuit board photomaster available upon request by contacting RF Tactical Marketing in Phoenix, AZ.

MRF899

150 W, 900 MHz
RF POWER
TRANSISTOR
NPN SILICON

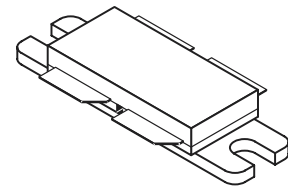

CASE 375A-01, STYLE 1

MAXIMUM RATINGS

Rating	Symbol	Value	Unit
Collector–Emitter Voltage	V_{CEO}	28	Vdc
Collector–Emitter Voltage	V_{CES}	60	Vdc
Emitter–Base Voltage	V_{EBO}	4.0	Vdc
Collector–Current — Continuous	I_C	25	Adc
Total Device Dissipation @ $T_C = 25^\circ\text{C}$ Derate above 25°C	P_D	230 1.33	Watts W/ $^\circ\text{C}$
Storage Temperature Range	T_{stg}	–65 to +150	$^\circ\text{C}$

THERMAL CHARACTERISTICS

Characteristic	Symbol	Max	Unit
Thermal Resistance, Junction to Case	$R_{\theta JC}$	0.75	$^\circ\text{C}/\text{W}$

ELECTRICAL CHARACTERISTICS ($T_C = 25^\circ\text{C}$ unless otherwise noted.)

Characteristic	Symbol	Min	Typ	Max	Unit
----------------	--------	-----	-----	-----	------

OFF CHARACTERISTICS

Collector–Emitter Breakdown Voltage ($I_C = 100 \text{ mAdc}$, $I_B = 0$)	$V_{(BR)CEO}$	28	37	—	Vdc
Collector–Emitter Breakdown Voltage ($I_C = 50 \text{ mAdc}$, $V_{BE} = 0$)	$V_{(BR)CES}$	60	85	—	Vdc
Emitter–Base Breakdown Voltage ($I_E = 10 \text{ mAdc}$, $I_C = 0$)	$V_{(BR)EBO}$	4.0	4.9	—	Vdc
Collector Cutoff Current ($V_{CE} = 30 \text{ Vdc}$, $V_{BE} = 0$)	I_{CES}	—	—	10	mAdc

ON CHARACTERISTICS

DC Current Gain ($I_{CE} = 1.0 \text{ Adc}$, $V_{CE} = 5.0 \text{ Vdc}$)	h_{FE}	30	75	120	—
---	----------	----	----	-----	---

DYNAMIC CHARACTERISTICS

Output Capacitance ($V_{CB} = 26 \text{ Vdc}$, $I_E = 0$, $f = 1.0 \text{ MHz}$) (1)	C_{ob}	—	75	—	pF
--	----------	---	----	---	----

(1) For information only. This part is collector matched.

(continued)



ELECTRICAL CHARACTERISTICS — continued ($T_C = 25^\circ\text{C}$ unless otherwise noted.)

Characteristic	Symbol	Min	Typ	Max	Unit
FUNCTIONAL CHARACTERISTICS					
Common-Emitter Amplifier Power Gain $V_{CC} = 26\text{ Vdc}$, $P_{out} = 150\text{ Watts (PEP)}$, $I_{cq} = 300\text{ mA}$, $f_1 = 900\text{ MHz}$, $f_2 = 900.1\text{ MHz}$	G_{pe}	8.0	9.0	—	dB
Collector Efficiency $V_{CC} = 26\text{ Vdc}$, $P_{out} = 150\text{ Watts (PEP)}$, $I_{cq} = 300\text{ mA}$, $f_1 = 900\text{ MHz}$, $f_2 = 900.1\text{ MHz}$	η	30	40	—	%
3rd Order Intermodulation Distortion $V_{CC} = 26\text{ Vdc}$, $P_{out} = 150\text{ Watts (PEP)}$, $I_{cq} = 300\text{ mA}$, $f_1 = 900\text{ MHz}$, $f_2 = 900.1\text{ MHz}$	IMD	—	-32	-28	dBc
Output Mismatch Stress $V_{CC} = 26\text{ Vdc}$, $P_{out} = 150\text{ Watts (PEP)}$, $I_{cq} = 300\text{ mA}$, $f_1 = 900\text{ MHz}$, $f_2 = 900.1\text{ MHz}$, VSWR = 5:1 (all phase angles)	ψ	No Degradation in Output Power Before and After Test			

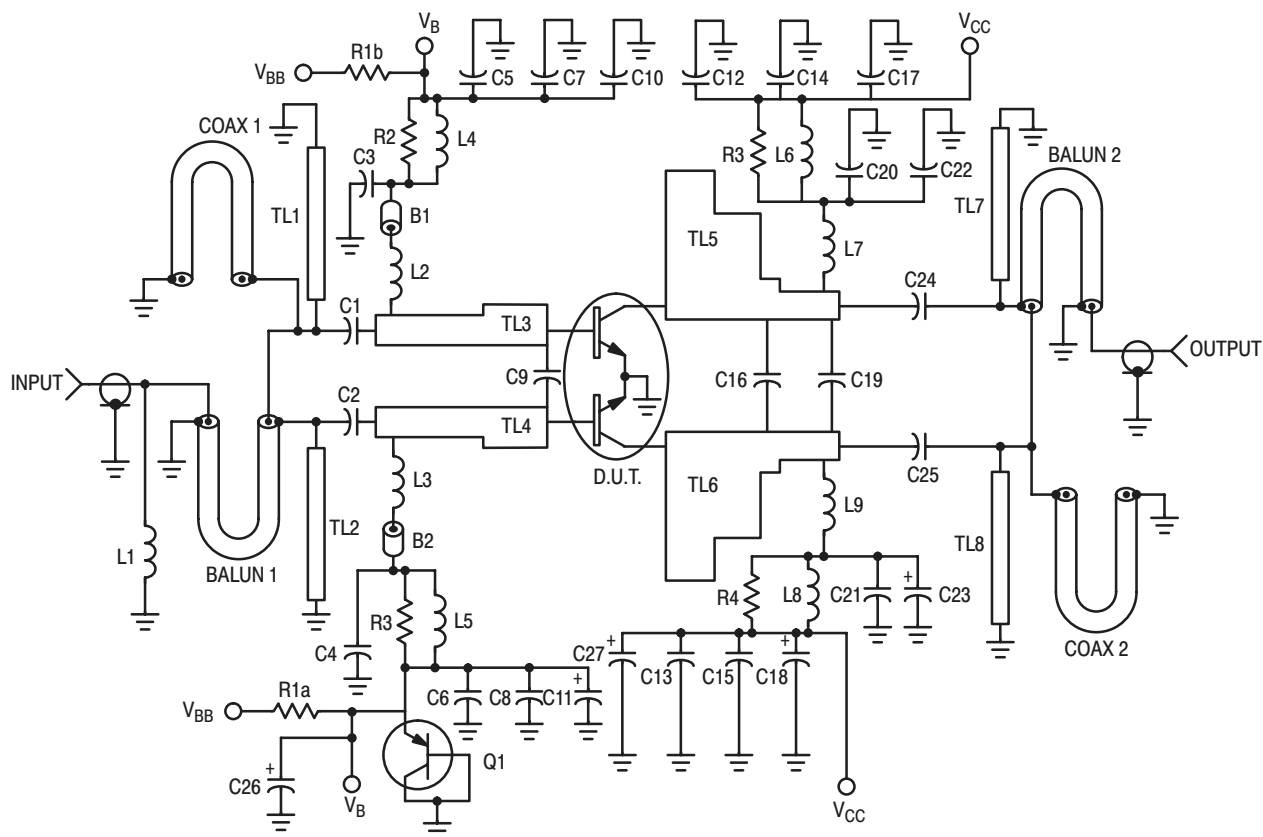

B1, B2 — Ferrite Bead, Ferroxcube #56-590-65-3B
 C1, C2, C24, C25 — 43 pF, B Case, ATC Chip Capacitor
 C3, C4, C20, C21 — 100 pF, B Case, ATC Chip Capacitor
 C5, C6, C12, C13 — 1000 pF, B Case, ATC Chip Capacitor
 C7, C8, C14, C15 — 1800 pF, AVX Chip Capacitor
 C9 — 9.1 pF, A Case, ATC Chip Capacitor
 C10, C11, C17, C18, C22, C23 — 10 μF , Electrolytic Capacitor

Panasonic
 C16 — 3.9 pF, B Case, ATC Chip Capacitor
 C19 — 0.8 pF, B Case, ATC Chip Capacitor
 C26 — 200 μF , Electrolytic Capacitor Mallory Sprague
 C27 — 500 μF Electrolytic Capacitor

L1 — 5 Turns 24 AWG IDIA 0.059" Choke, 19.8 nH
 L2, L3, L7, L9 — 4 Turns 20 AWG IDIA 0.163" Choke
 L4, L5, L6, L8 — 12 Turns 22 AWG IDIA 0.140" Choke
 N1, N2 — Type N Flange Mount, Omni Spectra
 Q1 — Bias Transistor BD136 PNP
 R2, R3, R4, R5 — 4.0 x 39 Ohm 1/8 W Chips in Parallel
 R1a, R1b — 56 Ohm 1.0 W
 TL1–TL8 — See Photomaster
 Balun1, Balun2, Coax 1, Coax 2 — 2.20" 50 Ohm 0.088" o.d.
 Semi-rigid Coax, Micro Coax
 Board — 1/32" Glass Teflon, $\epsilon_r = 2.55$ " Arlon (GX-0300-55-22)

Figure 1. 900 MHz Power Gain Test Circuit

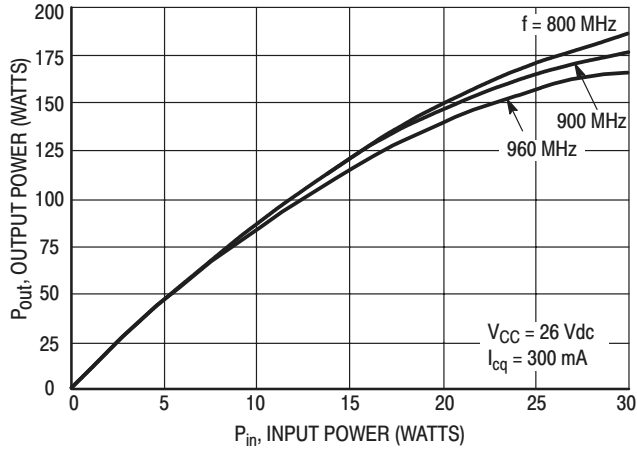

Figure 2. Output Power versus Input Power

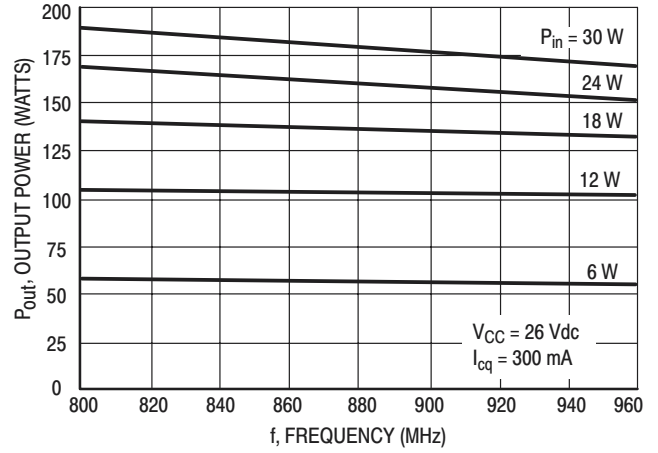

Figure 3. Output Power versus Frequency

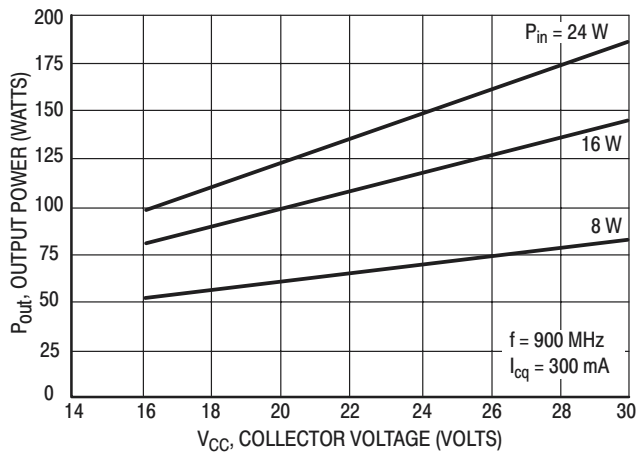

Figure 4. Output Power versus Supply Voltage

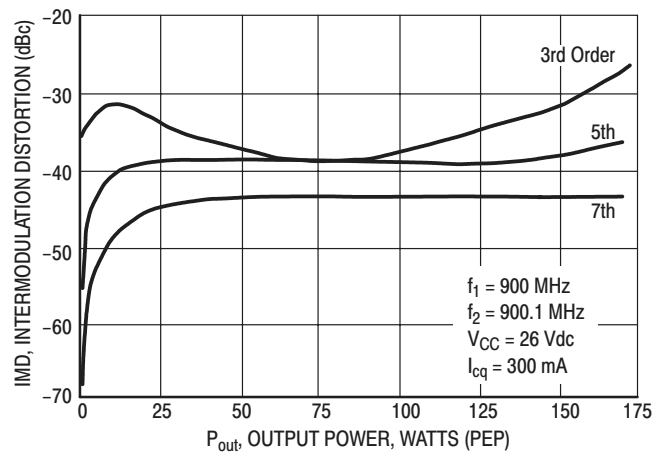

Figure 5. Intermodulation versus Output Power

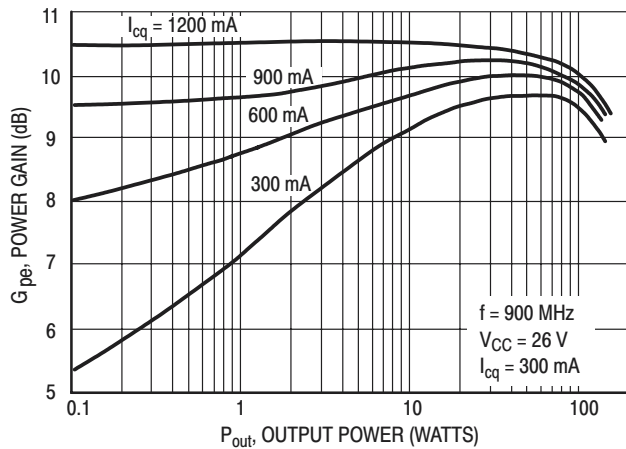

Figure 6. Power Gain versus Output Power

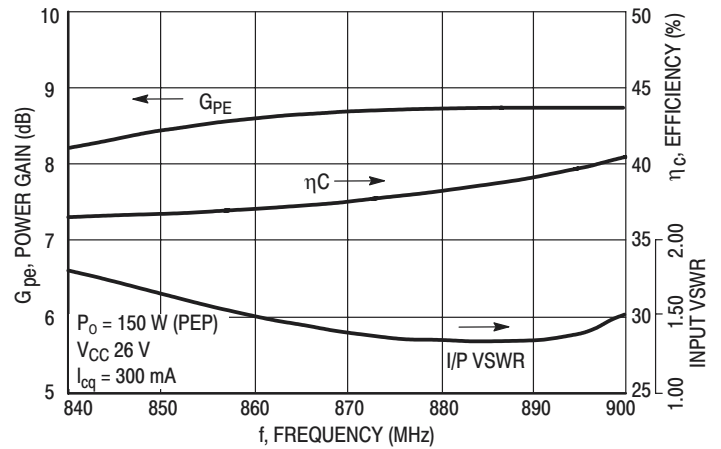
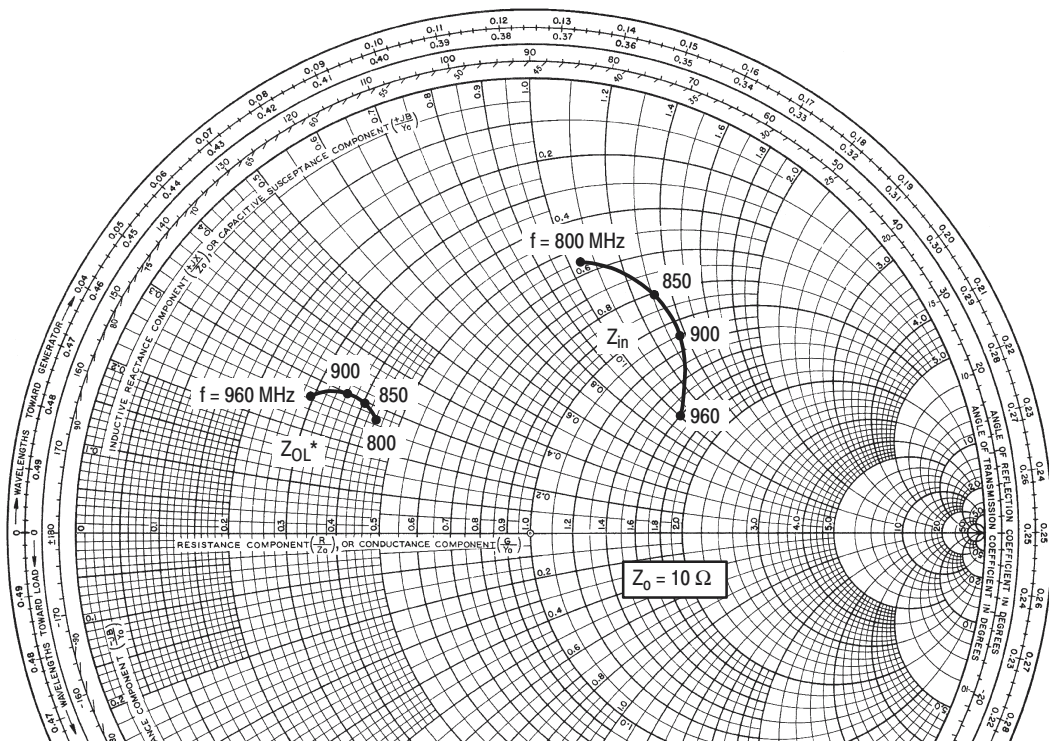

Figure 7. Broadband Test Fixture Performance



f MHz	Z _{in} Ohms	Z _{OL} * Ohms
800	5.51 + j10.6	4.52 + j2.64
850	8.17 + j13.2	4.21 + j2.98
900	11.2 + j13.8	3.68 + j2.97
960	16.8 + j10.1	2.98 + j2.71

NOTE: Z_{in} & Z_{OL}* are given from base-to-base and collector-to-collector respectively

Z_{OL}* = Conjugate of optimum load impedance into which the device operates at a given output power, voltage and frequency.

Figure 8. Input and Output Impedances with Circuit Tuned for Maximum Gain @ P_o = 150 W (PEP), V_{CC} = 26 V

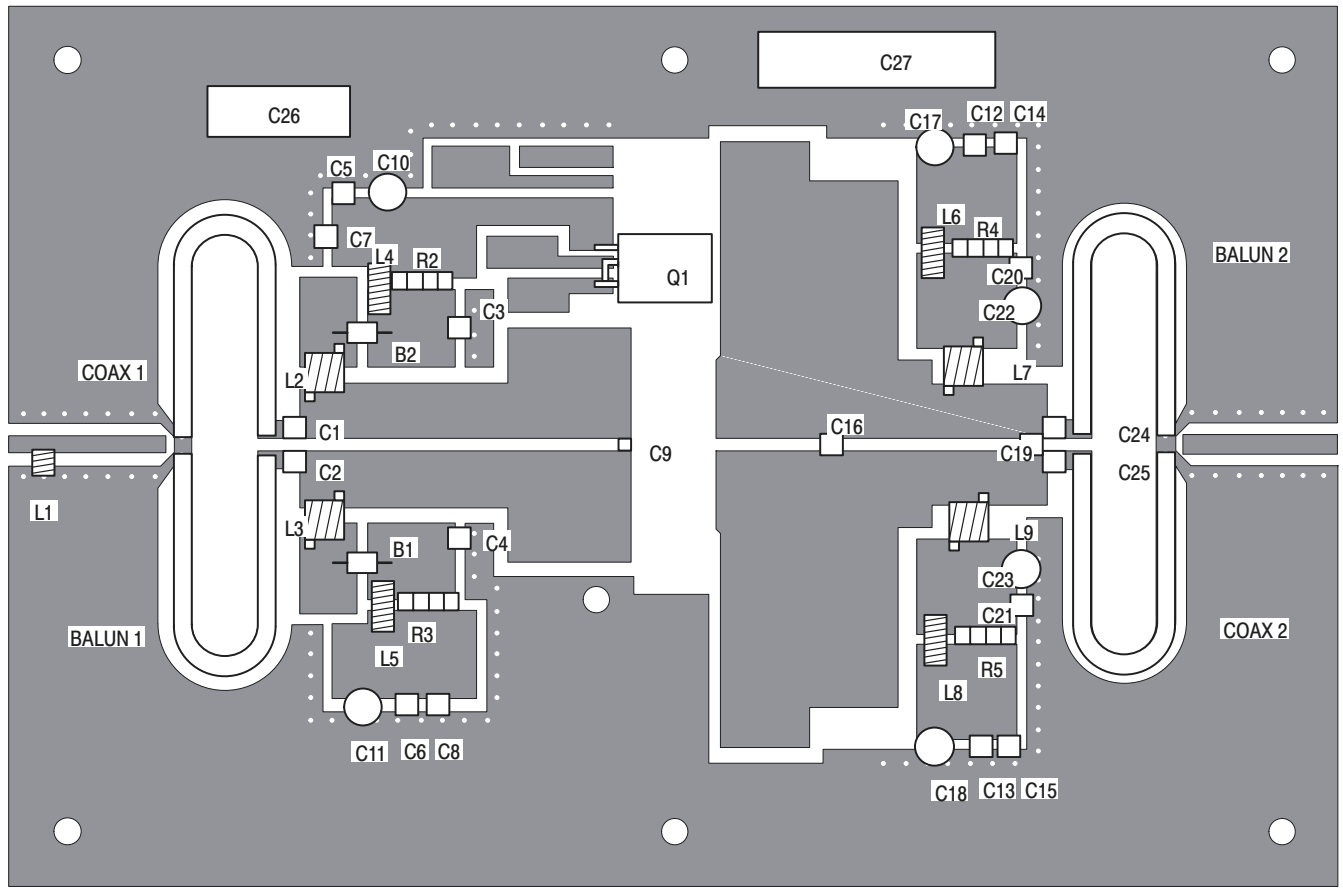
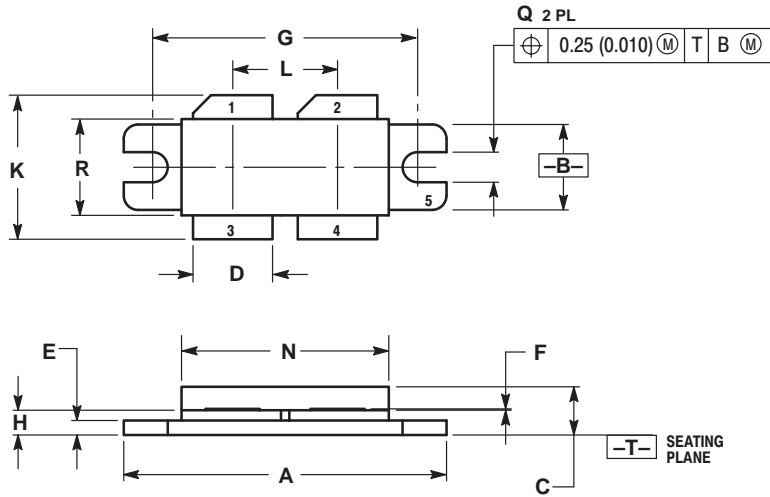

Figure 9. MRF899 Test Fixture Component Layout

PACKAGE DIMENSIONS



- NOTES:
 1. DIMENSIONING AND TOLERANCING PER ANSI Y14.5M, 1982.
 2. CONTROLLING DIMENSION: INCH.

DIM	INCHES		MILLIMETERS	
	MIN	MAX	MIN	MAX
A	1.330	1.350	33.79	34.29
B	0.375	0.395	9.52	10.03
C	0.180	0.205	4.57	5.21
D	0.320	0.340	8.13	8.64
E	0.060	0.070	1.52	1.77
F	0.004	0.006	0.11	0.15
G	1.100 BSC		27.94 BSC	
H	0.082	0.097	2.08	2.46
K	0.580	0.620	14.73	15.75
L	0.435 BSC		11.05 BSC	
N	0.845	0.875	21.46	22.23
Q	0.118	0.130	3.00	3.30
R	0.390	0.410	9.91	10.41

- STYLE 1:
 PIN 1. COLLECTOR
 2. COLLECTOR
 3. BASE
 4. BASE
 5. EMITTER

**CASE 375A-01
 ISSUE O**

ARCHIVE INFORMATION

ARCHIVE INFORMATION

Motorola reserves the right to make changes without further notice to any products herein. Motorola makes no warranty, representation or guarantee regarding the suitability of its products for any particular purpose, nor does Motorola assume any liability arising out of the application or use of any product or circuit, and specifically disclaims any and all liability, including without limitation consequential or incidental damages. "Typical" parameters which may be provided in Motorola data sheets and/or specifications can and do vary in different applications and actual performance may vary over time. All operating parameters, including "Typicals" must be validated for each customer application by customer's technical experts. Motorola does not convey any license under its patent rights nor the rights of others. Motorola products are not designed, intended, or authorized for use as components in systems intended for surgical implant into the body, or other applications intended to support or sustain life, or for any other application in which the failure of the Motorola product could create a situation where personal injury or death may occur. Should Buyer purchase or use Motorola products for any such unintended or unauthorized application, Buyer shall indemnify and hold Motorola and its officers, employees, subsidiaries, affiliates, and distributors harmless against all claims, costs, damages, and expenses, and reasonable attorney fees arising out of, directly or indirectly, any claim of personal injury or death associated with such unintended or unauthorized use, even if such claim alleges that Motorola was negligent regarding the design or manufacture of the part. Motorola and are registered trademarks of Motorola, Inc. Motorola, Inc. is an Equal Opportunity/Affirmative Action Employer.

Mfax is a trademark of Motorola, Inc.

How to reach us:

USA/EUROPE/Locations Not Listed: Motorola Literature Distribution;
 P.O. Box 5405, Denver, Colorado 80217. 303-675-2140 or 1-800-441-2447

JAPAN: Nippon Motorola Ltd.: SPD, Strategic Planning Office, 4-32-1,
 Nishi-Gotanda, Shinagawa-ku, Tokyo 141, Japan. 81-3-5487-8488

Mfax™: RMFA00@email.sps.mot.com – TOUCHTONE 602-244-6609
 – US & Canada ONLY 1-800-774-1848

ASIA/PACIFIC: Motorola Semiconductors H.K. Ltd.; 8B Tai Ping Industrial Park,
 51 Ting Kok Road, Tai Po, N.T., Hong Kong. 852-26629298

INTERNET: <http://motorola.com/sps>

