

IC-25A/E

144MHz FM TRANSCEIVER

INSTRUCTION MANUAL



TABLE OF CONTENTS

I. SPECIFICATIONS	1
II. DESCRIPTION	2
III. INSTALLATION	3
IV. CONTROL FUNCTIONS.....	6
V. OPERATION	10
VI. INSIDE VIEW	19
VII. CIRCUIT DESCRIPTION	20
VIII. TROUBLE-SHOOTING	31
IX. BLOCK DIAGRAM.....	33
X. P.C. BOARD LAYOUT.....	SEPARATE
XI. SCHEMATIC DIAGRAM.....	SEPARATE

SECTION I SPECIFICATIONS

GENERAL

Numbers of semi-conductors	: Transistor	48	
	FET	5	
	IC	21 (IC-25A : 20)	
	Diode	89 (IC-25A : 91)	
Frequency coverage	: 144.000 ~ 145.995MHz (IC-25A : 143.800 ~ 148.195MHz)		
Frequency resolution	: 5KHz/25KHz steps (IC-25A : 5KHz/15KHz steps)		
Frequency control	: Microcomputer based 5KHz step Digital PLL synthesizer Independent Dual VFO Capability.		
Frequency stability	: Within ± 1.5 KHz		
Memory channels	: 5 channels with any inband frequency programmable		
Usable conditions	: Temperature: $-10^{\circ}\text{C} \sim 60^{\circ}\text{C}$ ($14^{\circ}\text{F} \sim 140^{\circ}\text{F}$) Operational time: Continuous		
Antenna impedance	: 50 ohms unbalanced		
Power supply requirement	: 13.8V DC $\pm 15\%$ (negative ground) 6A Max.		
Current drain (at 13.8V DC)	: Transmitting	HIGH (25W)	Approx. 4.8A
		LOW (1W)	Approx. 1.3A
	Receiving	At max audio output	Approx. 0.6A
		Squelched	Approx. 0.4A
Dimensions	: 50mm(H) x 140mm(W) x 177mm(D)		
Weight	: Approx. 1.5kg		

TRANSMITTER

Output power	: 25W (HIGH), 1W (LOW)		
Emission mode	: 16F ₃		
Modulation system	: Variable reactance frequency modulation		
Max. frequency deviation	: ± 5 KHz		
Spurious emission	: More than 60dB below carrier		
Microphone	: 1.3Kohm dynamic microphone with built-in preamplifier and push-to-talk switch		
Operating mode	: Simplex, Duplex (Any inband frequency separation programmable)		
Tone burst	: 1750Hz ± 0.1 Hz (IC-25A : Not installed)		

RECEIVER

Receiving system	: Double-conversion superheterodyne		
Modulation acceptance	: 16F ₃		
Intermediate frequency	: 1st: 16.9MHz 2nd: 455KHz		
Sensitivity	: More than 30dB S+N+D/N+D at 1 μ V Less than 0.6 μ V for 20dB Noise quieting		
Squelch sensitivity	: Less than 0.4 μ V		
Spurious response rejection ratio	: More than 60dB		
Selectivity	: More than ± 7.5 KHz at -6 dB point Less than ± 15 KHz at -60 dB point		
Audio output power	: More than 2.0W		
Audio output impedance	: 4 ~ 8 ohms		

SECTION II DESCRIPTION

144MHz FM TRANSCEIVER INCORPORATING A MICROCOMPUTER

CPU control with ICOM's original programs provide various operating capabilities. No-backlash dial controlled by ICOM's unique rotary encoder circuit. The band-edge detector and Endless System provides out-of-band protection. There are no variable capacitors or dial gear, ensuring problem-free use. The IC-25A/E can accommodate FM, coverage in the 144 ~ 146MHz (IC-25A: 143.8 ~ 148.2MHz) frequency range.

MULTI-PURPOSE SCANNING

The Memory Scan allows you to monitor five different memory channels and two VFO frequencies, and the Program Scan provides scanning between two programmed frequencies. The scanning speed is adjustable, and the auto-stop terminates scanning when a signal is received or a channel is empty.

DUAL VFO'S

Two separate VFO's can be used independently either for simplex operation or for duplex operation, and any desired frequency can be split in duplex operation.

CONTINUOUS TUNING SYSTEM

ICOM's new continuous tuning system features an LED display that follows the tuning knob movement and provides an extremely accurate readout. Frequencies are displayed in 4 LED digits representing 5KHz digits.

Automatic recycling restarts tuning at the top of the band, i.e., at 145.995MHz when the dial goes below 144.000MHz. Recycling changes 145.995MHz to 144.000MHz as well. Quick tuning in 25KHz steps (IC-25A : 15KHz) is available with VFO "B", and is also provided for trouble free QSO (IC-25A : 145.995MHz and 144.000MHz should be read 148.195MHz and 143.800MHz.)

OUTSTANDING PERFORMANCE

The RF amplifier using a MOS FET and the first mixer using a double balanced mixer, and other circuits provide excellent cross modulation and two-signal selectivity characteristics. The IC-25A/E has excellent sensitivity demanded especially for mobile operation, high stability, and with a pair of high quality monolithic crystal filters and ceramic filters facilitates very stable receiving and excellent durability.

The transmitter uses the double balanced mixer (the same one for receiver) in a single conversion system, a band-pass filter and a high-performance low-pass filter. This system provides distortion-free signals with a minimum spurious radiation level.

The IC-25A/E has everything you need to truly enjoy VHF FM operation, in an extremely compact, rugged transceiver, designed to ensure high quality, long term use.

SECTION III INSTALLATION

UNPACKING

Carefully remove your transceiver from the packing carton and examine it for signs of shipping damage. Should any be apparent, notify the delivering carrier or dealer immediately, stating the full extent of the damage. It is recommended you keep the shipping cartons. In the event storage, moving, or reshipment becomes necessary, they come in handy. Accessory hardware, cables, etc., are packed with the transceiver. Make sure you have not overlooked anything.

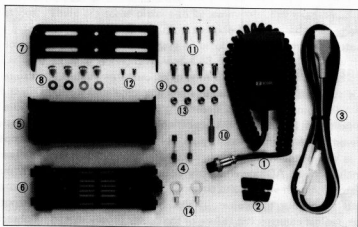

1. Microphone (dynamic type IC-HM7)	1	8. Gimp screws	4
2. Microphone hook	1	9. Flat washers	12
3. Power cord	1	10. Plug for speaker	1
4. Spare fuses (10A)	2	11. Mounting screws	8
5. Installing holder A	1	12. Screws for additional bracket	2
6. Installing holder B	1	13. Mounting screw's nuts	4
7. Installing angle joint	1	14. Battery terminal lugs	2

Note: Some version supplies IC-HM8 (dual tone encoder mic) instead of IC-HM7.

LOCATION

Where you place the transceiver in your automobile is not critical and should be governed by convenience and accessibility. Since the unit is so compact, many mobile possibilities present themselves. In general, the mobile mounting bracket will provide you with some guide as to placement. Any place where it can be mounted with metal screws, bolts, or pop-rivets will work. For fixed station use, a power supply should be designed to produce 6 amps for the transceiver.

Mounting bracket installation

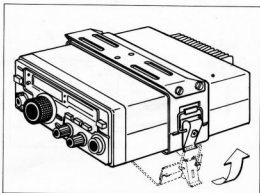
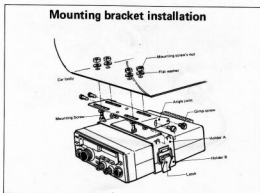

Angle adjustment

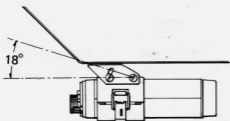

Optional installation

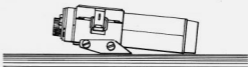

POWER REQUIREMENTS

The transceiver is supplied ready to operate from any regulated 13.8V DC, 6 ampere negative ground source. An automobile 12 volt, negative ground, system is usually more than adequate. Some note must be taken, however, of the condition of the vehicle's electrical system. Items such as low battery, worn generator/alternator, poor voltage regulator, etc., will impair operation of your transceiver as well as the vehicle. High noise generation or low voltage delivery can be traced to these deficiencies. If an AC power supply is used with your transceiver, make certain it is adequately regulated for both voltage and current. Low voltage while under load will not produce satisfactory results from your transceiver. Receiver gain and transmitter output will be greatly impaired. Caution against catastrophic failure of the power supply should be observed.

CAUTION: Excessive Voltage (above 15VDC) will cause damage to your transceiver. Be sure to check source voltage before plugging in the power cord.

Included with your transceiver is a DC power cable with plug attached. The Red Wire is positive (+), the Black, negative (-). If your mobile installation permits, it is best to connect these directly to the battery terminals. This arrangement eliminates random noise and transient spikes sometimes found springing from automotive accessory wiring. If such an arrangement is not possible, then any convenient B+ lead in the interior of the vehicle and the negative frame can be utilized. Remember, the unit operates on a negative ground system only; it cannot be used in a positive ground automobile. After making your connections, simply insert the plug into your transceiver.

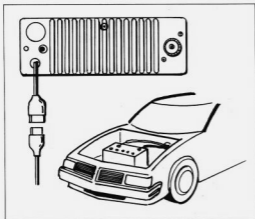

Do not use a cigarette lighter socket.



ANTENNA

The most important single item that will influence the performance of any communication system is the antenna. For that reason, a good, high-quality, gain antenna of 50 ohms impedance is recommended, fixed or mobile. In VHF as well as the low bands, every watt of ERP makes some difference. Therefore, 25 watts average output plus 3dB of gain antenna equals 50 watts ERP, presuming low VSWR of course. The few extra dollars invested in a gain type antenna is well worth it. When adjusting your antenna, whether mobile or fixed, by all means follow the manufacturer's instructions. There are some pitfalls to be aware of. For example, do not attempt to adjust an antenna for lowest VSWR when using a diode VSWR meter not engineered for VHF applications. Such readings will invariably have an error of 40% or more. Instead, use an in line watt meter similar to the Drake WV-4, Bird Model 43 or Sierra Model 164B with VHF cartridge. Further, when adjusting a mobile antenna, do so with the motor running preferably above normal idling speed. This will insure proper voltage level to the transceiver.

The RF coaxial connector on the rear panel mates with a standard PL-259 connector. Some models may have metric threads. In any event, the RF connector will mate with almost any PL-259 connector if care is taken to seat them properly.

MICROPHONE

A high quality dynamic microphone with built-in preamplifier is supplied with your transceiver. Merely plug it into the proper receptacle on the front panel. Should you wish to use a different microphone, make certain it has a proper preamplifier. Particular care should be exercised in wiring also, as the internal electric switching system is dependent upon it. See the schematic for the proper hook up.

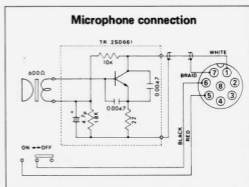
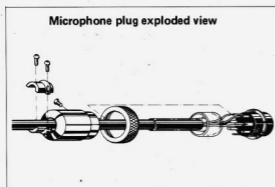

EXTERNAL SPEAKER

An external speaker jack and plug is supplied with your unit in the event another speaker is desirable. The external speaker impedance should be 4 ~ 8 ohms, and when used, will disable the internal speaker. A 4 ~ 16 ohm headset can be utilized as well.

SECTION IV CONTROL FUNCTIONS

FRONT PANEL

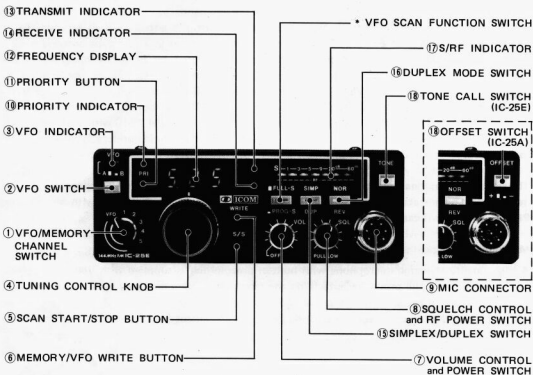

1. VFO/MEMORY CHANNEL SWITCH

Selects operation with the tuning control ("VFO" position) or operation with the memory channels (1 ~ 5). See "PROGRAMMING THE MEMORY CHANNELS" on page 13 for more details.

2. VFO SWITCH

Selects either VFO, "A" or "B", for tuning. In the "A" position, the VFO indicator is lit and the frequency changes 5KHz steps by turning the tuning control knob. In addition, this frequency can be memorized into any memory channel. In the "B" position, the frequency changes 25KHz steps (IC-25A : 15KHz steps) by turning the tuning control knob.

3. VFO INDICATOR

When the VFO A is selected, this indicator illuminates.

4. TUNING CONTROL KNOB

Rotating the TUNING CONTROL KNOB clockwise increases the frequency, while rotating it counterclockwise decreases the frequency. The frequency is changed in 5KHz steps with the VFO "A", and 25KHz steps (IC-25A : 15KHz steps) with the VFO "B", when tuning up past 145.995MHz (IC-25A : 148.195MHz), the frequency will automatically revert to 144.000MHz (IC-25A : 143.800MHz). Likewise, when tuning down past 144.000MHz (143.800MHz), the frequency will automatically revert to 145.995MHz (148.195MHz).

5. SCAN START/STOP BUTTON

Starts and stops any of the scan functions. When depressing it again to restart the scan, it will start from the stopped memory channel or frequency.

6. MEMORY/VFO WRITE BUTTON

By pushing this button, VFO A's frequency is written into a memory channel, or one VFO's frequency is transferred to the other VFO.

7. VOLUME CONTROL and POWER SWITCH

When the control is turned completely counterclockwise, the power is OFF. By turning the control clockwise beyond the "click", the unit is turned ON and the audio level increases by further rotating it clockwise.

8. SQUELCH CONTROL and RF POWER SWITCH

Turning this control clockwise sets the squelch threshold higher. To turn OFF the squelch function, turn this control completely counterclockwise.

By pulling the Squelch control knob, the RF output power is reduced to 1 watt. By depressing the knob to the normal position, the RF output power returns to 25 watts.

9. MIC CONNECTOR

Connect the supplied microphone to this jack. If you wish to use a different microphone, refer to the drawing on page 5.

10. PRIORITY INDICATOR

Illuminates when the priority function is turned ON.

11. PRIORITY BUTTON

Turns the priority function ON and OFF.

During a QSO or receiving with VFO, if you would like to watch your favorite channel or a calling channel, that is busy or empty, set the memory channel switch to the favorite or calling channel which is memorized in a memory channel, and push the priority button, and the receiving frequency will go to the channel a moment at every five seconds.

12. FREQUENCY DISPLAY

The three large 7 segment LED's represent the digits between 1MHz and 10KHz and an LED for 5KHz of the operating frequency. The frequency indicated is the carrier frequency.

13. TRANSMIT INDICATOR

Illuminates in the transmit mode.

14. RECEIVE INDICATOR

Illuminates when the squelch is opened in the receive mode.

15. SIMPLEX/DUPLEX SWITCH

Selects the SIMPLEX operation or the DUPLEX (repeater) operation.

16. DUPLEX MODE SWITCH

Selects the relationship of the receiving frequency and the transmitting frequency in the duplex mode.

In the "NOR" position, the transmitting frequency is set 600KHz (This can be changed to any in-band frequency.) below the receiving frequency. (IC-25A : The transmitting frequency can be set either below or above the receiving frequency by the OFFSET switch.)

In the "REV" position, the transmitting frequency and receiving frequency are reversed the above function.

These operations may be utilized with the VFO or any memory channels.

17. S/R/F INDICATOR

Indicates S-unit and RF output level with seven LED's in line. The numbers on the S-meter represent S1 through S9 and 20 and 60dB over S9. The RF output level meter functions only as a relative output meter and does not indicate the wattage. These functions are switched automatically when T/R switching is made.

18. TONE CALL SWITCH (IC-25E only)

Most repeaters require a 1750Hz Tone-burst for initial access. Depressing the Tone Call Switch for the required period for a repeater, puts the set in the transmit mode and the tone burst generator actuates so you can then access the repeater.

18'. OFFSET SWITCH (IC-25A only)

In the "+" position, the transmitting frequency is set 600KHz (This can be changed to any in-band frequency.) above the receiving frequency. (When the DUPLEX MODE Switch is in the "NOR" position.)

In "-" position, the transmitting frequency is set 600KHz below the receiving frequency. Also the offset frequency can be changed to any in-band frequency. (When the DUPLEX MODE Switch is in the "NOR" position.)

* VFO SCAN FUNCTION SWITCH

Selects the VFO FULL RANGE SCAN which scans the entire band or the PROGRAMMED SCAN which scans between two specified frequencies.

REAR PANEL

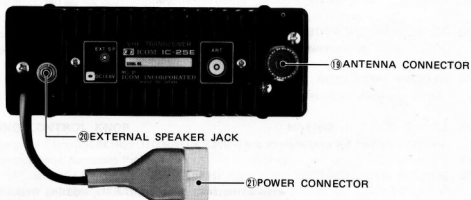

19. ANTENNA CONNECTOR

This is used to connect the antenna to the set. Its impedance is 50 ohms and connects with a PL-259 connector.

20. EXTERNAL SPEAKER JACK

When an external speaker is used, connect it to this jack. Use a speaker with an impedance of 4 ~ 8 ohms. When the external speaker is connected the built-in speaker does not function.

21. POWER CONNECTOR

Connect the supplied power cord to this connector.

UNDER THE TOP COVER

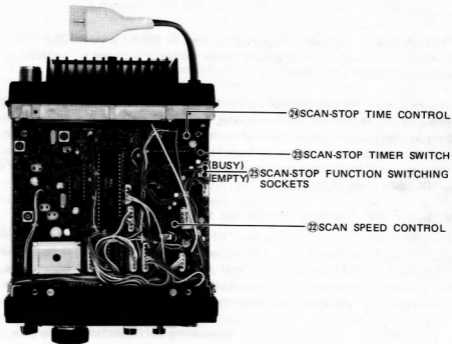

22. SCAN SPEED CONTROL

Controls the scanning speed in any scan mode. Adjust the control to desired scanning speed.

23. SCAN-STOP TIMER SWITCH

Switches the scan-stop interval function ON and OFF.

24. SCAN-STOP TIME CONTROL

Controls the interval of the scan auto-stopping time. Adjust the control to desired interval. It can be adjustable between 5 to 20 seconds.

25. SCAN-STOP FUNCTION SWITCHING SOCKETS

Switches the scan-stop function to either stop on a busy channel or stop on an empty channel, by changing the socket.

HOW TO TUNE

The following instructions are for tuning in any mode. Please read carefully and understand fully before turning ON your unit. Proper tuning is necessary for optimum operation.

PRESET FREQUENCIES

When the POWER Switch is turned ON, the frequency display will be "5.00" representing 145.000 MHz (IC-25A : "6.01" representing 146.010MHz). The frequencies of the VFO's and the Memory Channels are preset so that they start from the frequencies shown above whenever the IC-25A/E is turned ON.

TUNING CONTROL

Rotating the Tuning Knob clockwise increase the frequency; turning it counterclockwise decreases the frequency in 5KHz steps when VFO "A" is used, or in 25KHz (IC-25A : 15KHz) steps when VFO "B" is used.

The click stops of the knob change in 5KHz steps or 25KHz steps (IC-25A : 15KHz steps). One complete rotation of the tuning knob results frequency increases or decreases of a 250KHz or 1,250KHz (IC-25A : 750KHz).

When you reach 145.995MHz, turning the Tuning Control knob clockwise will bring the operating frequency to 144.000MHz, the lowest edge, and you can continue increasing the frequency from there by continuing to rotate the knob clockwise. The VFO endless system functions in the same way when decreasing the frequency from 144.000MHz, and will prevent you from inadvertently operating out of the amateur radio band. (IC-25A : 145.995MHz and 144.000MHz should be read as 148.195MHz and 143.800MHz.)

VFO/MEMORY CHANNEL SWITCH and VFO SWITCH

The CPU in the IC-25A/E contains two "VFO's" for both receiving and transmitting. The VFO's are labeled "A" VFO and "B" VFO and are selectable with the VFO Switch, when the VFO/MEMORY CHANNEL Switch is the VFO position. The dual VFO system gives the IC-25A/E many very convenient features. Please read this section very carefully and perform the operation several times until you are comfortable with the system. Try the example for practice!

1. "A" VFO is for both transmitting and receiving and is selected by placing the VFO Switch in the "A" (out) position. The transmit and receive frequency will be controlled by "A" VFO, displayed on the frequency display and stored in "A" memory.
2. "B" VFO is for both transmitting and receiving and is selected by placing the VFO Switch in the "B" (in) position. The transmit and receive frequency will be controlled by "B" VFO, displayed on the frequency display, and stored in "B" memory.

NOTE: The memory channel positions are described in the "MEMORY CHANNEL OPERATION" on page 13.

- When the IC-25A/E is first turned ON, 145.000MHz (IC-25A : 146.010MHz) is preset into the VFO "A" and VFO "B".

FOR EXAMPLE:

When the VFO Switch is set in the "A" position and the set is turned ON, "5.00" will be displayed on the readout representing 145.000MHz. (IC-25A: "6.01" representing 146.010MHz). This will occur whether the VFO switch is in either the "A" or "B" position. Rotating the tuning control knob clockwise will increase the frequency, and rotating the tuning knob counterclockwise will decrease the frequency in 5KHz steps with VFO "A", or in 25KHz (IC-25A : 15KHz) steps with VFO "B".

- Switching from one VFO to the other VFO does not clear the first VFO. The frequency is retained in the VFO's memory.

FOR EXAMPLE:

If 145.125MHz is set with "A" VFO, and the VFO switch is set to "B" VFO, the frequency readout will show "B" VFO's frequency, but 145.125MHz is still stored in "A" VFO's memory. Returning the VFO Switch to "A" VFO position, and "5.125" will be displayed on the readout. Accordingly, if the switch is placed in the "B" VFO position, the frequency that was set with the "B" VFO will appear. This allows you to set a certain frequency with one VFO, work up and down the band with the other VFO, and periodically check the set frequency simply by switching between "A" and "B" VFO. It also allows you to search for a clear frequency with one VFO, while keeping your operating frequency on the other VFO. When you have found a clear frequency, switch back to your operating frequency, inform the station you are in contact with of the new frequency, and switch back. It's that simple!

TRANSFERING VFO FREQUENCY

The MEMORY/VFO WRITE button allows either VFO's to be brought to the exact frequency of the other VFO without turning the tuning control knob.

FOR EXAMPLE:

When "A" VFO is 144.255MHz and "B" VFO is 144.355MHz, pushing the VFO Switch to select "B" VFO, then the MEMORY/VFO WRITE button, "B" VFO's frequency becomes the same as "A" VFO's (144.255MHz). Now the "A" VFO's frequency is memorized in the "B" VFO, and you can operate anywhere with "A" VFO or "B" VFO. When you want to return to the previous frequency (144.255MHz), switch back to the other VFO. To reverse this (A the same as B), select "A" VFO first, then push the MEMORY/VFO WRITE button.

DUPLEX (REPEATER) OPERATION

The SIMPLEX/DUPLEX Switch and DUPLEX MODE Switch allow DUPLEX (repeater) operation. The offset frequency is preset for the standard separation; 600KHz, but this frequency can be reset for any in-band frequency. So you can access to any repeater.

1. When the SIMPLEX/DUPLEX Switch is in the "SIMP" position, the set is in SIMPLEX mode; the receive frequency and transmit frequency are controlled a frequency which is by placing the VFO/MEMORY CHANNEL Switch and VFO Switch in any position of "A", "B" or Memory Channel 1 ~ 5.
2. When the SIMPLEX/DUPLEX Switch is in "DUP" position and the DUPLEX MODE Switch is in "NOR" position, the set is in DUPLEX mode, and the transmit frequency is set 600KHz (or reset offset frequency) below the receive frequency. (IC-25A : When the OFFSET Switch is in "-" positin.)

3. When the SIMPLEX/DUPLEX Switch is in "DUP" position and the DUPLEX MODE Switch is in "REV" position, the set is in DUPLEX mode, and the receive frequency becomes the expecting transmit frequency and the transmit frequency becomes the previous receive frequency, so you can receive the repeater's input frequency, or you can access a repeater which has reverse input/output frequencies.

NOTE: IC-25A; The OFFSET frequency can be set either below or above the receiving frequency by the OFFSET switch.

- "NOR" or "REV" position will allow you to access a repeater that has a 600KHz input/output frequency separation.

FOR EXAMPLE:

Set "A" VFO to 145.725MHz. Then set the SIMPLEX/DUPLEX Switch to the "DUP" position and the DUPLEX MODE Switch to the "NOR" position. 5.725 will be shown on the readout during receive and 5.125 during transmit. You are now receiving on 145.725MHz and transmitting on 145.125MHz, so you can access 145.125/145.725 repeater.

If you change the receiving ("A" VFO) frequency from 145.725MHz to 145.675MHz, the transmitting frequency will change from 145.125MHz to 145.075MHz, so now you can access a 145.075/145.675 repeater.

If you set the DUPLEX MODE Switch to the "REV" position, the receiving frequency will be 145.075MHz and the transmitting frequency will be 145.675MHz. So you can receive the repeater's input frequency.

These functions will be available also in "B" and Memory 1 ~ 5 positions of the VFO MEMORY CHANNEL Switch.

RESETTING THE OFFSET FREQUENCY

The offset frequency can be reset to any in-band frequency other than 600KHz.

Set the VFO/MEMORY CHANNEL Switch in the "VFO" position. By pushing the PRIORITY button, the FREQUENCY DISPLAY shows 1MHz digit and 100KHz digit of the offset frequency while the button is pushed. If no offset frequency has been reset since turning the power of the set ON, "0.6" will be shown on the display.

Rotating the Tuning control knob clockwise increases the frequency; turning it counterclockwise decreases the frequency in 100KHz steps. Turn the tuning control knob to obtain desired offset frequency, then push the MEMORY/VFO WRITE button, and the desired offset frequency is written into the CPU and maintained as long as the power of the set is not turned OFF or a new offset frequency is reset.

- What to do if you want to operate repeaters that have a frequency difference other than $\pm 600\text{KHz}$ (for example : 1MHz).

FOR EXAMPLE:

Set the VFO/MEMORY CHANNEL Switch in the "VFO" position, and by pushing the PRIORITY button, the FREQUENCY DISPLAY shows "0.6". Turn the tuning control knob clockwise to

show "1.0" on the display, then push the MEMORY/VFO WRITE button.

Set "A" VFO to 145.725MHz. Then set the DUPLEX MODE Switch to the "NOR" position. 5.725 will be shown on the display during receive and 4.725 during transmit.

You are now receiving on 145.725MHz and transmitting on 144.725MHz, so you can access a 144.725/145.725 repeater.

If you change the receiving frequency from 145.725MHz to 145.675MHz, the transmitting frequency will change from 144.725MHz to 144.675MHz, so now you can access a 144.675/145.675 repeater.

MEMORY CHANNEL OPERATION

MEMORY-WRITE (PROGRAMMING THE MEMORY CHANNELS)

NOTE: Only "A" VFO can be used for memory-writing.

1. Set the Tuning Control to the desired frequency, using "A" VFO. For example, set it for 145.700MHz, the display shows "5.70".
2. Set the VFO MEMORY CHANNEL Switch to the channel to be programmed (1 ~ 5). As an example, set it at Memory Channel 1. If no frequency has been programmed since turning the power of the unit ON, "5.00" will be shown on the display (IC-25A : "6.01"), and the unit will receive on 145.000MHz (IC25A : 146.010MHz).
3. One push of the MEMORY/VFO WRITE Button erases the previous programmed frequency (145.000) and programs the new frequency (145.700) into Memory Channel 1.
4. Program any desired frequencies in Memory Channels 2 ~ 5 in the same manner. Memory Channels 1 and 2 are used also for the Programmed Scan. For Programmed Scan operation, refer to SCANNING OPERATION.

MEMORY READING

Set the VFO/MEMORY CHANNEL Switch to the desired memory channel 1, 2, or 5. At that frequency the "A" or "B" VFO was set, that previously programmed frequency is then recalled. When the VFO/MEMORY CHANNEL Switch is set back to "VFO", the previous operating frequency of that VFO will again be shown on the display.

The programmed frequencies in the five Memory Channels are maintained as long as the power, including MEMORY BACKUP power, of the IC-25A/E is not turned OFF or new frequencies reprogrammed. When the power cord is connected to a continuous operating power source, all the programmed frequencies on the Memory Channels and the operating frequencies of both "A" and "B" VFO's are retained even when the POWER Switch is turned OFF.

SCANNING OPERATION

The IC-25A/E provides various scanning operations. Please read the following instructions carefully to fully enjoy the IC-25A/E's many capabilities.

MEMORY SCAN

This is to scan the five Memory Channels and two VFO's frequencies continuously.

1. Program five desired frequencies in Memory Channels 1 ~ 5.
2. Set the VFO/MEMORY CHANNEL Switch to the memory position. (The VFO/MEMORY CHANNEL Switch may be set in any position.)

- Depress the S/S (Scan Start/Stop) button, and the frequency starts scanning the programmed frequencies in the Memory Channels 1, 2, 3, 4, 5, then "A" VFO and "B" VFO, 1, 2, 3, 4, 5, "A" VFO, "B" VFO.
- If the SQUELCH is engaged, the scan stops when the squelch is opened and receives a signal. To stop scanning without opening the squelch, depress the S/S Button. Depress it again to restart the scanning.
This function can be changed to stop when the squelch is closed, i.e., an empty channel, by the SCAN-STOP FUNCTION SWITCHING SOCKETS located under the top cover.

PROGRAMMED SCAN

This is used to scan between two desired frequencies, which are programmed in Memory Channels 1 and 2, by setting the VFO-SCAN FUNCTION Switch located on the front panel to "PROG-S" position.

- Program the frequencies of the high edge of the desired scanning range into Memory Channel 2, and the low edge into Memory Channel 1.
For example, program 145.200MHz into Memory Channel 1 and 145.800MHz into Memory Channel 2.
- Set the VFO/MEMORY CHANNEL Switch to VFO position. Depressing the S/S Button starts the scan from the high edge (145.800MHz) to the low edge. The scanning frequency increments depend on the VFO Switch setting.
- When the scanning frequency reaches the lowest edge (145.200MHz), it automatically returns to the high edge (145.800MHz) and continues scanning down to provide endless scanning operation.
- While the SQUELCH is engaged, the squelch opening as a signal is received will stop the scanning automatically to lock onto the frequency. If the RECEIVE indicator LED is lit because the SQUELCH is not engaged, the scan does not stop at any signal.
- To stop the scan operation, depress the S/S Button. Depressing the S/S Button again restarts the scan from the frequency at which it stopped.
- If this frequency is changed with turning the Tuning Control knob while the scan is stopped, the scanning will restart from the VFO frequency.

In this case, if the VFO frequency is below the low edge frequency, the frequency jumps to the high edge frequency (145.800MHz) and restarts from the high edge.

If the changed frequency is higher than the high edge frequency and the S/S Button is pushed, scanning will begin at the VFO frequency, scan down to the low edge but will return to the preprogrammed high edge frequency.

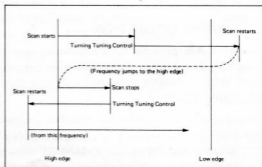
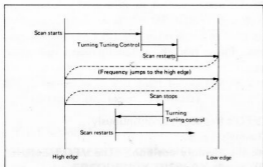

VFO FULL RANGE SCAN

This is to scan the entire band between 144.000MHz and 145.995MHz. (IC-25A : between 143.800MHz and 148.195MHz.)

1. Set the VFO/MEMORY CHANNEL Switch to VFO position, and the VFO-SCAN FUNCTION Switch to "FULL-S" position. Depressing the S/S button starts the scan from the VFO frequency to the low edge. The scanning frequency increments depend on the VFO Switch setting.
2. When the scanning frequency reaches the low edge, it automatically returns to the high edge and continues scanning down to provide endless scanning operation.
3. Other operations are the same as the PROGRAMMED SCAN and MEMORY SCAN.

The scanning speed can be adjusted by the SCAN SPEED Control located under the top cover. Rotating the control counterclockwise makes the scanning speed faster.

While the SCAN is operating even if the SCAN stops on a frequency, the decimal point of the frequency display will blink according to the scanning speed.

RESUMING SCAN

All scan modes are provided with the resume scan function. When the scan has been stopped by the auto-stop function, the scan will restart after the cause goes away, or after passing a specified time.

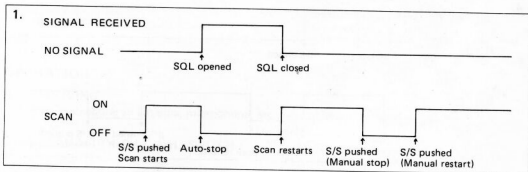

By setting the SCAN-STOP TIMER Switch in OFF position and the SCAN-STOP FUNCTION SWITCHING SOCKETS in BUSY position (both located under the top cover), the scan will stop on a signal (by opening the squelch), then the scan will restart with disappearing the signal.

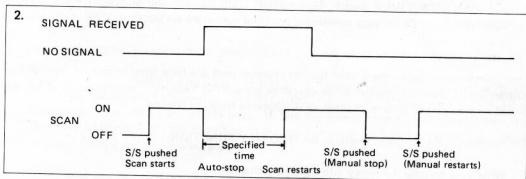

By setting the SCAN-STOP TIMER Switch in ON position and the SCAN-STOP FUNCTION SWITCHING SOCKETS in BUSY position, the scan will stop on a signal, and will restart after specified time is passed, whether a signal has been received or not. This scan stopping time is adjustable between 5 seconds and 25 seconds with the SCAN-STOP TIME CONTROL located under the top cover.

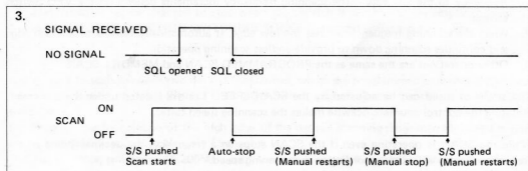

By setting the SCAN-STOP FUNCTION SWITCHING SOCKETS in EMPTY position and the SCAN-STOP TIMER Switch in OFF position, the scan will stop on an empty channel (by closing the squelch), then the scan will restart with appearing a signal.

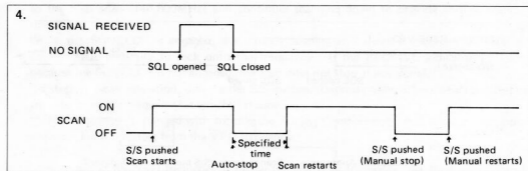

By setting the SCAN-STOP FUNCTION SWITCHING SOCKETS in EMPTY position and the SCAN-STOP TIMER Switch in ON position, the scan will stop on an empty channel, then will restart after specified time is passed, whether a signal has been received or not.

Set the SCAN-STOP TIMER Switch, SCAN-STOP TIME Control, and SCAN-STOP FUNCTION SWITCHING SOCKETS for your convenient positions before the set installed.

PRIORITY FUNCTION

This function provides to check your favorite channel, such as a local repeater or a calling channel, written into a memory channel while operating on a VFO frequency, whether a signal has appeared on the selected favorite channel, or disappeared from the channel.

The following steps are taken to utilize the PRIORITY FUNCTION.

1. Write your favorite frequency into a memory channel.

- Set the VFO MEMORY CHANNEL Switch in the position written with your favorite frequency, and push VFO/MEMORY CHANNEL Switch, and the set then receives on the memory channel.
- By pushing the PRIORITY button, the PRIORITY INDICATOR is lit and the set receives on a VFO frequency, a period of five seconds and on the priority channel (written with your favorite frequency) one second, and then repeats this function until the PRIORITY button is pushed again.
- If the set is turned to transmit mode, during the priority function, the transmit frequency will be the VFO frequency in SIMPLEX mode, or its OFFSET frequency in DUPLEX mode. When returned to receive mode, the priority function will be continued.
- If you wish to stop the priority function, push the PRIORITY button again, and the PRIORITY indicator is turned OFF and the operating frequency goes to the priority channel's frequency.
- If you wish to continue the operation on the VFO frequency, set the VFO/MEMORY CHANNEL Switch to the VFO position.

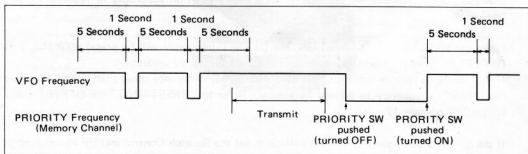

OPERATION

1. RECEIVING

After connecting an antenna, microphone, etc., set knobs and switches as follows.

VFO/MEMORY CHANNEL SWITCH	"VFO"
VFO SWITCH	"A" (out)
VOLUME CONTROL and POWER SWITCH	Completely counterclockwise (OFF position)
SQUELCH CONTROL and RF POWER SWITCH	Completely counterclockwise (Pull switch is normal position.)
SIMPLEX/DUPLEX SWITCH	"SIMP" (out)
DUPLEX MODE SWITCH	"NOR" (out)
OFFSET SWITCH (IC-25A only)	"-" (in)

The other switches are unrelated to receiving and need not be set at this time.

Now turn ON the POWER SWITCH. The RECEIVE indicator will be illuminated and "5.00" (IC-25A : "6.01") will be shown on the FREQUENCY DISPLAY. Slowly turn the VOLUME Control clockwise to a comfortable level. Rotate the tuning knob until a signal is received. The S/RF indicator will light according to the signal strength, so tune for the highest possible indicator reading and the clearest audio.

If no signal can be heard but only noise, turn the Squelch Control clockwise until the noise

from the speaker stops and set it just below this threshold. (When adjusting the Squelch control setting, if some communication signals can be heard, turn the tuning control either direction and set it where only noise can be heard.) The transceiver will now remain silent until an incoming signal is received which opens the squelch and lights the RECEIVE indicator. If the squelch is unstable due to the reception of weak signals or mobile stations, adjust the squelch control further until the proper threshold is obtained.

For tuning, Memory Channel operation and Scanning operation refer to "HOW TO TUNE" on page 10, "Memory CHANNEL OPERATION" on page 13, and "SCANNING OPERATION" on page 13,

2. TRANSMITTING

For simplex operation, set the SIMPLEX/DUPLEX Switch in the "SIMP" position.

For duplex operation, set the SIMPLEX/DUPLEX Switch in the "DUP" position and the DUPLEX MODE Switch in the "NOR" or "REV" position according to repeater's input frequency.

When the IC-25A/E is first turned ON, the OFFSET frequency will be preset 600KHz. This OFFSET frequency is normal repeater input/output frequency separation.

If you desire to operate repeaters that have a frequency difference other than $\pm 600\text{KHz}$, reset the OFFSET frequency to desired frequency. Refer to "RESETTING THE OFFSET FREQUENCY" on page 12.

If the lower output power (1 watt) is sufficient, set the Squelch Control and RF Power Switch to the LOW (out) position.

Depress the PTT (push-to-talk) Switch on the microphone and the transceiver will transmit. At the same time the TRANSMIT indicator will illuminate red and the S/RF indicator will provide an indication of relative power output of the transmitter.

If you need a tone-burst for initial access of the repeater, depress the Tone Call Switch for the required period. (Tone-burst periods vary individually from 100 milliseconds to 2 seconds.) (IC-25A : The Tone Call circuit is not installed.)

SECTION VI INSIDE VIEW

MAIN UNIT SIDE

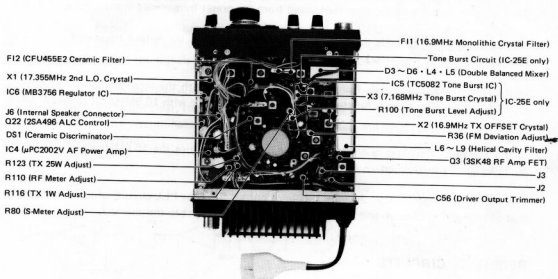

PLL UNIT SIDE

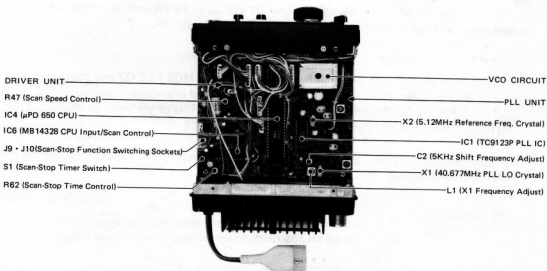

SECTION VII CIRCUIT DESCRIPTION

OUTLINE

The IC-25A/E employs a digital phase locked loop (PLL) circuit as the local oscillator for both transmit and receive. The output of the PLL circuit is approximately 16.9MHz below the receive frequency, thereby spurious is kept to a minimum.

The operating frequency is controlled by pulse signals, generated by the rotary encoder located at the tuning knob, being added to or subtracted from the preset frequencies in the microcomputer.

The microcomputer controls the PLL circuit which determines the output frequency of the VCO (Voltage Controlled Oscillator).

In the receiver section, signals from the antenna are mixed with the local oscillator output from the PLL circuit. The circuits function as a dual-conversion type with 16.9MHz 1st IF and 455KHz 2nd IF.

In the transmitter section, a crystal oscillator is used to produce the 16.9MHz signals which are direct-frequency modulated.

The FM signal is mixed with the local oscillator output from the PLL circuit, which is the same as that of the receiver section, and then amplified, filtered, and sent to the antenna.

RECEIVER CIRCUITS

ANTENNA SWITCHING CIRCUIT

Signals from the antenna connector are fed to the RF amplifier Q3 in the MAIN unit through low-pass filters in the PA unit. The switching diodes D1 and D2 in the PA unit, are turned OFF in the receive mode, and isolate the PA module from the receiver circuit.

RF CIRCUIT

The signals from the PA unit, are amplified by the low-noise MOS FET Q3 and then sent to the four-stage helical cavity filter, which reduces interference and intermodulation from other radio signals or nearby signals. The filtered signals are then fed to one of the ports of the double balanced mixer (DBM) consisting of four Schottky diodes, D3 ~ D6.

To another port of the DBM, a 127MHz signal is supplied from the PLL unit to convert the RF signals into first IF signals.

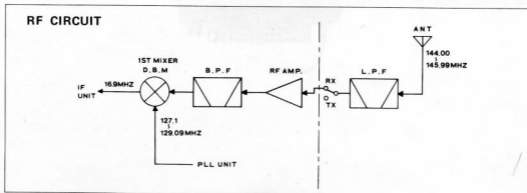

The 16.9MHz, first IF signals are taken from the other port of the DBM through a monolithic crystal filter F11, then fed to the IF circuit.

IF CIRCUIT

16.9MHz 1st IF signals from the crystal filter F11 are fed to the 1st gate of the dual gate MOS FET Q2. Signals amplified by Q2 are supplied together with 17.355MHz signals from the second local oscillator Q1, to the base of second mixer Q10, for conversion to the 455KHz second IF.

In the second IF amplifier, which has excellent selectivity due to a CFU455E ceramic filter, signals are amplified by Q11 – Q13 and Q14. After removal of noise and other AM components by IC3 functioning as a limiter, the signals are detected in terms of audio frequency signals by a ceramic discriminator.

This ceramic discriminator has outstanding temperature characteristics, linearity and detection sensitivity, which guarantee clear, stable reception.

Audio signals from the discriminator are divided into audio signals and noise component signals to operate the squelch circuit.

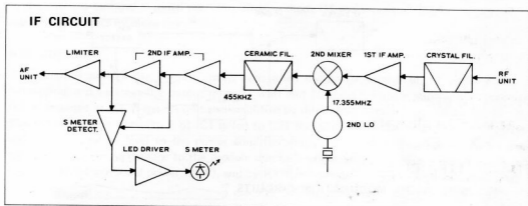

AUDIO CIRCUIT

In the audio amplifier, audio signals are passed through the de-emphasis circuit consisting of R85 and C78, and amplified by Q15. High frequency components are cut by a low-pass filter Q16, in order to improve the signal-to-noise ratio. Then the audio signals are adjusted to a suitable level by volume control R1, amplified by AF power amplifier IC4 to 2W or more, and fed to the speaker.

SQUELCH CIRCUIT

This is a noise circuit that suppresses noise when signals enter the set. To avoid erroneous operation due to audio signals, noise components of about 25KHz are selectively amplified.

Squelch control R2 is located immediately after the discriminator, thus increasing the dynamic range of the circuit.

Noise components from squelch control R2 are amplified by Q17 and Q18, rectified by D16 and D17, and with C103, C105, and R112 ensure correct timing sequence for smooth squelching supplied to the base of squelch control transistor Q19.

When there are no audio signals, rectified DC voltage from D16 and D17 is applied to the base of Q19, turning it on. Since the collector of Q19 is connected to the base bias network of AF amplifier Q15, base voltage of Q15 falls and Q15 is turned off, thus squelch action is applied, and no audio is amplified by IC4. At this time, signal lamp control IC, IC3 of DRIVER unit, does not conduct, and so the RECEIVE lamp goes off.

When incoming signals are received, noise is suppressed, the base voltage of Q19 falls, and Q19 is turned off. Therefore, normal voltage is applied to the base of Q15, the squelch circuit is opened, and audio signals are heard from the speaker. IC3 also is turned on, and the RECEIVE lamp lights up.

The point at which squelch becomes operative (squelch threshold) is adjusted by R2.

During transmit, Q19's collector is grounded through D18 and PTT switch, and the squelch circuit is operative, so squelch action is started the moment there is switchover from transmit to receive, and no loud crackling or similar noise is heard.

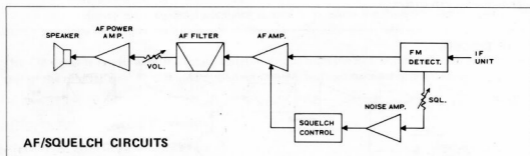

TRANSMITTER CIRCUITS

16.9MHz OSCILLATOR, MODULATION CIRCUITS

16.9MHz signals are oscillated by Q6 and amplified audio signals from the microphone are supplied to varactor diode D10 connected in series with the crystal unit. Voltage of these signals causes the capacitance of D10 to vary, and frequency modulation is effected. Since this transceiver is a heterodyne type, any frequency deviation that occurs in this circuit appears unchanged as a frequency deviation in the 144MHz band, and so use is made of a crystal unit with special characteristics to ensure suitable frequency deviation and stability.

AUDIO FREQUENCY CIRCUIT

Audio signals from the microphone are fed to the audio amplifier Q4. Amplified signals are sent through a differential circuit C24 and R26 to Pin 3 of IC1, which is a limiter amplifier and has 6dB/Octave response between 300Hz and 3KHz. This output is fed to low-pass filter Q5, and then the FM modulator D10, through level adjust trimmer R36.

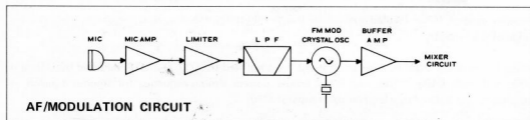

MIXER CIRCUIT

These modulated signals are taken out at the emitter of Q6, and after amplified by IC2, are applied to the same DBM that is used for the receiver.

127MHz band signals from the PLL unit, are mixed with the 16.9MHz modulated signals to give signals of $127\text{MHz} \pm 16.9\text{MHz}$. As a double balanced mixer is used for this mixing stage, 16.9MHz and 127MHz band signals are canceled and do not appear in the output.

DRIVER CIRCUIT

The signals are further passed through a helical cavity band-pass filter, to produce signals in the 144MHz band only, and then amplified by Q7, Q8, Q9, and fed to PA module IC1 in the PA unit.

POWER AMPLIFIER CIRCUIT

The signals from Q9 in the MAIN unit are amplified by IC1 in the PA unit to obtain 25W output. The heat from IC1 is transmitted to the diecast heat sink which radiates the heat very efficiently. IC1 is a hybrid IC consisting of a two-stage RF power amplifier. The output signals of IC1 are fed to the antenna terminal through the T/R switching diode D1 and three-stage low-pass filter, which suppress harmonics by more than 60dB.

ALC CIRCUIT

This circuit stabilizes the output power, even when the power voltage or the antenna load is fluctuating, and switches the output power 1 watt and 25 watts. The variation in the current of IC1 is detected at R1 in the PA unit and amplified by differential amplifier IC1 in the MAIN unit. The output voltage from Pin 7 of IC1 is fed to Q21 then Q22. This lowers Q9's collector voltage and input excitation level to the power amplifier module and reduces input power to the final stage, thus preventing damage to the module due to high current. The output power can be adjusted by R124 in normal power (25W), and by R116 in low power (1W) conditions.

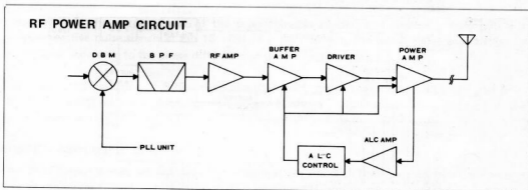

METERING CIRCUIT

In the receive mode, the S/R/F indicator functions as an S-meter. A part of the second IF signals from L21 is rectified by D11 and D12 (for weak signals), and from Q13's collector is rectified by D20 and D21 (for stronger signals). Both rectified signals are fed to the indicator driver IC, and provide wide dynamic range meter function.

In the transmit mode, the S/R/F indicator functions as a relative RF power meter. A part of the

RF power output is fed to D4 in the PA unit and rectified, then fed to the indicator driver IC through the level adjust resistor R110.

POWER SUPPLY CIRCUIT

This circuit employs a multipurpose voltage regulator, IC6. It puts out a constantly activated 8V, R8V which is operative during receive, and T8V which is operative during transmit. R8V is put out from Pin 6, and T8V is put out from Pin 8 of IC6. By grounding Pin 5, R8V goes 0V and T8V is actuated, thus the set will be turned to transmit mode.

PLL (PHASE LOCKED LOOP) UNIT

LOCAL OSCILLATOR CIRCUIT

This circuit produces 40.677MHz signal with Q1, and the signal at 3 times this frequency, i.e., 122.03MHz, are taken from the collector of Q1.

When the operating frequency, has 5KHz digit, D1 is turned OFF and C2 is inserted in series into the serial capacitor of the crystal. Thus the output frequency of the local oscillator is shifted +5KHz.

MIXER, LOW PASS FILTER, AND AMPLIFIER CIRCUIT

The output signals from the local oscillator circuit and the VCO signals are mixed by the MOS FET mixer Q5. The output signals are fed to the low-pass filters to filter out only the signals below 15MHz. The output signals from the filter are amplified to the proper drive level (more than 3Vp-p) of the programmable divider IC1 by Q2. Then the signals are fed to Pin 12 of IC1 through C9.

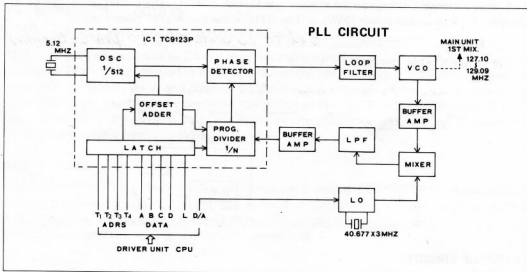

PROGRAMMABLE DIVIDER CIRCUIT

The input signals at Pin 12 of the PLL IC, IC1, consists of programmable divider, reference frequency generator and phase detector, are divided by the BCD input signals at Pins 6 ~ 9 and its digit signals at Pins 2 ~ 5.

The programmable divider is also called the 1/N counter and the BCD input is N. The relationship between the display frequency and the divide number N is as follows:

DISPLAY FREQUENCY	CPU OUTPUT	DIVIDE NUMBER (N)
144.000MHz	400	507
144.010MHz	401	508
}	}	}
145.000MHz	500	607
}	}	}
146.000MHz	600	707
}	}	}
147.000MHz	700	807
}	}	}
148.000MHz	800	907

REFERENCE FREQUENCY GENERATOR CIRCUIT

Reference frequency generator consists of a crystal oscillator and a highspeed divider. X2 oscillates at 5.12MHz, which is divided by 512. The 10KHz reference frequency is fed to phase detector. This 10KHz reference frequency decides the variation step of the PLL output frequency and the divide number N decides the PLL output frequency.

$$\text{PLL output freq.} = \text{local oscillator freq. (MHz)} + 0.01\text{MHz (the reference freq.)} \times N \text{ (divide number of programmable divider)}$$

NOTE: The local oscillator frequency is 122.03MHz or 122.035MHz (when the operating frequency has 5KHz digit).

PHASE DETECTOR AND LOOP FILTER CIRCUIT

Digital phase detector detects the phase difference of the pulse signals of the 10KHz reference frequency, and the output signal of the programmable divider, and proportionately puts out positive/negative pulse signals at Pin 16. Pin 18 is for detecting the lock failures and changes to ground level according to the phase difference of the two pulse signals.

The loop filter, consisting of R26 ~ R28 and C28, C29 and C31, converts the pulse signal from Pin 16 into a DC voltage and decides the response time of the whole loop. The output signals are fed to tuning diode D5 of the VCO unit as the control voltage for the VCO frequency set.

BUFFER AMPLIFIER CIRCUIT

The VCO output signals are fed to buffer amplifiers Q6 and Q7. They are then fed to the second gate of the mixer Q3 through isolation buffer amplifier Q4, and to the transmit and receive mixer through a buffer amplifier Q8.

VCO UNIT

The VCO (Voltage-Controlled Oscillator) is a Clapp circuit, using Q5, and oscillates in the 127MHz range. The oscillation frequency is controlled by a DC voltage which is supplied from the loop filter in the PLL unit to varactor diode D5, inserted in series with the oscillation coil.

The oscillator output is taken from the source of Q5, and fed to buffer amplifiers Q6, Q7 and Q8.

OFF. So the oscillation frequency is decided by C7 only and the frequency is higher and the scan speed is fast. When a memory channel is selected (in the memory scan function), a voltage is applied to ④, Q9 is turned ON and C8 is paralleled to C7. Thus the oscillation frequency is lowered and the scan speed is slow.

In the MIC UP/DOWN function (when using an optional UP/DOWN microphone IC-HM10), as the UP button on the microphone is depressed, the ⑤ point is grounded and the multivibrator starts oscillation. In this case, Pin 3 is grounded through D25 only and near ground level. Thus the upward scanning is selected. When the DOWN button is depressed the ⑤ point is grounded through a 470 ohms resistor installed inside the microphone. So the voltage divided by R60 and the 470 ohms resistor, is applied to Pin 3 and the downward scanning is selected.

CPU CONTROL CIRCUIT

The CPU in the unit is a 4-bit CPU and the input terminals are A0 ~ A3 and B0 ~ B3.

Since the CPU cannot make many functions with the small number of A and B input signals, scanning E output signals and decoded O0 ~ O7 signals by IC1, and are fed to A and B input terminals through the matrix circuit. The CPU reads the relationship of E output, and A and B input signals to decide the function as follows:

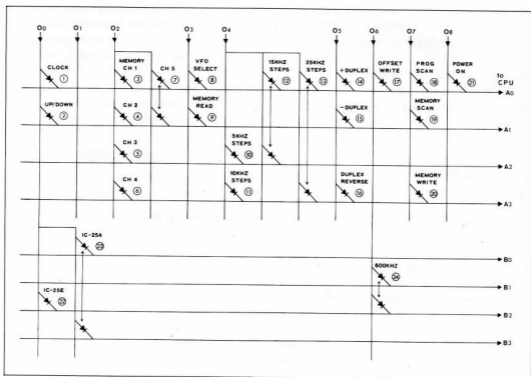

① O0 → A0 (Clock)

This flow occurs when the frequency is moved up or down with each pulse input by turning the tuning control knob or scanning.

- ② **O0 → A1 (Up/Down)**
This flow occurs when the frequency is moved up. When the frequency is moved down, the O0 signal is not fed to A1.
- ③ **O2 → A0 (Memory Channel 1)**
This flow occurs when the VFO/MEMORY CHANNEL Switch is set at "1".
- ④ **O2 → A1 (Memory Channel 2)**
This flow occurs when the VFO/MEMORY CHANNEL Switch is set at "2".
- ⑤ **O2 → A2 (Memory Channel 3)**
This flow occurs when the VFO/MEMORY CHANNEL Switch is set at "3".
- ⑥ **O2 → A3 (Memory Channel 4)**
This flow occurs when the VFO/MEMORY CHANNEL Switch is set at "4".
- ⑦ **O2 → A0, A1 (Memory Channel 5)**
This flow occurs when the VFO/MEMORY CHANNEL Switch is set at "5".
- ⑧ **O3 → A0 (VFO Select)**
This flow occurs when the VFO Switch is set in "B", and the unit operates at the frequency set by "B" VFO. When the VFO Switch is set in "A", the O3 signal is not fed to A0, and the unit operates at the frequency set by "A" VFO.
- ⑨ **O3 → A1 (Memory Read)**
This flow occurs when the VFO/MEMORY CHANNEL Switch is set at a memory channel, and the set operates on the channel. This function is prior to the function ⑧.
- ⑩ **O4 → A2 (5KHz Steps)**
This flow occurs when the VFO Switch is set at "A", and the operating frequency is moved up or down with 5KHz steps.
- ⑪ **O4 → A3 (10KHz Steps)**
When this flow occurs, the operating frequency is moved up or down with 10KHz steps. (This mode is not used for IC-25A/E.)
- ⑫ **O4 → A0, A2 (15KHz Steps)**
When this flow occurs, the operating frequency is moved up or down with 15KHz steps. (This mode is used for VFO B of IC-25A.)
- ⑬ **O4 → A0, A3 (25KHz Steps)**
When this flow occurs, the operating frequency is moved up or down with 25KHz steps. (This mode is used for VFO B of IC-25E.)
- ⑭ **O5 → A0 (+Duplex)**
This flow occurs when the OFFSET Switch is set at "+", and the transmit frequency becomes a frequency which is added the specified offset frequency to the receive frequency. (This mode is not used for IC-25E.)

15 O5 → A1 (-Duplex)

This flow occurs when the OFFSET Switch is set at “-”, and the transmit frequency becomes a frequency which is subtracted the specified offset frequency from the receive frequency. (This mode is preset for IC-25E.)

16 O5 → A3 (Duplex Reverse)

This flow occurs when the OFFSET Switch is set at “+” or “-” and the DUPLEX MODE Switch is in “REV” position, the receive frequency becomes a frequency which is added to, the specified offset frequency or subtracted it from the original receive frequency, and the transmit frequency becomes the original receive frequency.

NOTE: In the duplex operation, if an expecting transmit frequency becomes out of the band, this frequency will remain at the original receive frequency.

17 O6 → A0 (Offset Write)

This flow occurs when the VFO/MEMORY CHANNEL is set at “VFO” position and the PRIORITY button is pushed, and the offset frequency can be reset by turning the tuning control knob.

18 O7 → A0 (Programmed Scan)

When this flow occurs, and the S/S button is depressed, the operating frequency scans between frequencies written into the Memory Channels 1 and 2. (Memory Channel 2 should be written higher frequency than Memory Channel 1, if not the scan function does not actuate.) When this flow does not occur and the S/S button is depressed, the operating frequency scans the entire band.

19 O7 → A1 (Memory Scan)

When this flow occurs, the operating frequency scans on the memory channels and the VFO's A and B.

20 O7 → A3 (Memory Write)

When a memory channel is selected and this flow occurs, a frequency of the VFO A is written into the selected memory channel.

When a VFO is selected and this flow occurs, a frequency of the other VFO is written into the selected VFO.

21 O8 → A0 (Power ON)

This flow occurs when the POWER Switch is turned ON. When this flow does not occur, the CPU is in stand by condition.

NOTE: The port B is used to initialize the CPU when the power is turned ON.

22 O0 → B2

When this flow occurs, the operating frequency range is selected between 144.000MHz and 145.995MHz. (This mode is used for IC-25E.)

23 O0 → B0, B3

When this flow occurs, the operating frequency range is selected between 143.800MHz and 148.195MHz. (This mode is used for IC-25A.)

④ O6 → B1, B2

When this flow occurs, the offset frequency is preset for 600KHz.

FREQUENCY CONTROL, DISPLAY AND I/O CIRCUIT

The dynamic lighting display functions with the 7-segment data output which are decoded by IC2 from BCD output at the E0 ~ E3 terminals of the CPU and the digit designation output signals at the F0 ~ F3 terminals. The decimal point is illuminated with the current through scan blinking transistor Q15, only when the digit designation signals for the 1MHz order is put out. The E0 ~ E3 terminals are timeshared for the other data output. The E0 ~ E3 terminals also put out the divide number (N) for the PLL divider, and supplied to the CPU control circuit through IC1.

When the power is turned ON, the CPU is initialized and then reads the mode setting and memorizes it. Then the CPU reads the control data from the external controller in the order of the numbers of the matrix and controls the various necessary operations. The data of the display, "A" VFO, "B" VFO, the frequency shift, step pitch, Memories 1 ~ 5, and the divide number (N) are programmed in each RAM area for the initial presetting.

Then, at the CPU output terminals E0 ~ E3, the divide number and the 5KHz shift data are put out in the BCD code. The data to designate the latch position (digit-position) are output at the CPU output D0 ~ D3 and the signals from G3 are latched as the strobe pulse in the PLL IC.

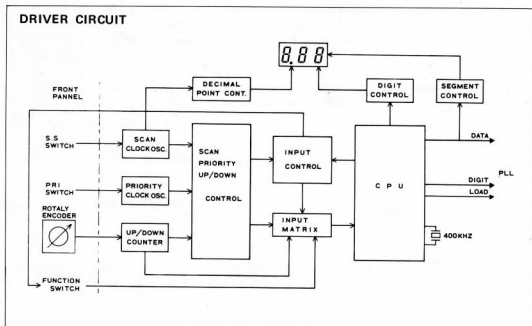

SECTION VIII TROUBLE-SHOOTING

Your IC-25A/E has been tested very carefully at the factory before shipping. The chart below has been designed to help you correct any problems which are not equipment malfunctions. If you are not able to locate the problem and/or solve it through use of this chart, please contact your dealer or ICOM distributor for assistance.

Problem	Possible Cause	Solution
1. Power does not come ON when the switch is turned.	Power cord is improperly connected. Power cord is connected with the polarity reversed. Blown fuse.	Carefully reconnect power cord. Disconnect the power cord, replace the blown fuse, then reconnect the power cord observing proper polarity. Check for the cause, then replace the fuse with a new one.
2. No sound comes from the speaker.	VOLUME Control knob is completely counterclockwise, but not "clicked OFF". The unit is in the transmit mode, by the PTT Switch on the microphone. SQUELCH setting is turned too far clockwise. External speaker is in use. The internal speaker cable is not connected.	Turn the knob clockwise to a suitable level. Put the unit in the receive mode. Turn the SQUELCH control counterclockwise until noise can be heard and reset it just below the threshold. Check if the external speaker plug is inserted properly or if the external speaker cable is cut. Connect the speaker connection.
3. Sensitivity is low and only strong signals are audible.	The antenna feed line is cut or shorted.	Check the feed line and correct any improper condition.
4. No or low RF output.	RF Power Switch is set at the Low position. PTT Switch is not functioning due to bad connection of the MIC connector. The antenna feeder is cut or shorted.	Set the RF Power Switch to the High (normal) position. Check the connection of the MIC connector and correct any problems. Check the antenna feeder and correct any problems.
5. No modulation.	Bad connection of the MIC connector. The MIC cable is cut.	Check the connection of the MIC connector and correct any problems. Repair the disconnected or cut wire.

Problem	Possible Cause	Solution
<p>6. The receive mode functions properly and your signals are transmitted, but you are unable to make contact with another station.</p>	<p>The SIMPLEX/DUPLEX Switch is in "DUP" position. (When desiring SIMPLEX mode.)</p> <p>The SIMPLEX/DUPLEX Switch is in "SIMP" position. (When desiring DUPLEX mode.)</p> <p>Improper frequency split or input/output frequency of the repeater.</p>	<p>Set the SIMPLEX/DUPLEX Switch to the "SIMP" position.</p> <p>Set the SIMPLEX/DUPLEX Switch to the "DUP" position.</p> <p>Set the proper frequency split and set the DUPLEX MODE Switch to the "NOR" or "REV" position, or the OFFSET Switch to the "+" or "-" position according to repeater input/output frequency.</p>
<p>7. The memorized frequencies are lost and the display shows 5.00 (IC-25A : 6.01) when power switch is turned ON.</p>	<p>The main switch of the power source was turned OFF or the power plug was unplugged.</p> <p>The power failed (when using the AC power source).</p>	<p>Use the continuous operating power source or optional memory power source.</p>
<p>8. The memory scan operation does not function when the S/S Switch is pushed.</p>	<p>No frequency is programmed in the memory channels or the same frequency is programmed in all the memory channels.</p> <p>The VFO/MEMORY CHANNEL Switch is not in a Memory Channel position.</p>	<p>Program the required frequencies in the memory channels following the instructions for "MEMORY CHANNEL OPERATION" on page 13.</p> <p>Set the VFO/MEMORY CHANNEL Switch in a Memory Channel position.</p>
<p>9. The programmed scan operation does not function when the S/S Switch is pushed.</p>	<p>The same frequency is programmed in the memory channel 1 and 2, or the programmed frequency in the memory channel 1 is higher than the one in the channel 2.</p> <p>The VFO/MEMORY CHANNEL Switch is not in the VFO position.</p>	<p>Program the low edge frequency into the memory channel 1, and the high edge frequency into the memory channel 2.</p> <p>Set the VFO/MEMORY CHANNEL Switch in the VFO position.</p>
<p>10. The scan does not stop even if a signal is received.</p>	<p>The squelch has opened when the scan started.</p>	<p>Engage the squelch on a no signal frequency, then start the scan by pushing the S/S Switch.</p>



ICOM INCORPORATED
1-6-19, KAMI KURATSUKURI, HIRANO-KU,
OSAKA JAPAN

A-0337
Printed in Japan