

144/220 MHz FM MULTI BANDER
TM-641A
144/440 MHz FM MULTI BANDER
TM-741A
144/430 MHz FM MULTI BANDER
TM-741A
144/430 MHz FM MULTI BANDER
TM-741E

INSTRUCTION MANUAL

KENWOOD CORPORATION

©PRINTED IN JAPAN B62-0082-0(K/M/C)
92/12 11 09 8 7 6 5 4 3 2 1

KENWOOD

KENWOOD

Save this instruction manual.

Thank you for purchasing this new transceiver.

IMPORTANT:
Please read this instruction manual carefully before placing your transceiver in service.

CAUTION:

Long transmission or extended operation in the HI power mode might cause the rear of this transceiver to get warm.
Do not place the transceiver where the heat sink (rear panel) might come in contact with plastic or vinyl surfaces.

This instruction Manual covers the following models.

- TM-641A: 144/220MHz FM MULTI BANDER (U.S.A. version)
- TM-71A: 144/440MHz FM MULTI BANDER (U.S.A. and Canadian version)
- TM-71A: 144/430MHz FM MULTI BANDER (General markets)
- TM-71E: 144/430MHz FM MULTI BANDER (European markets)

NOTE:
If disregarded, inconvenience only, no risk of equipment damage or personal injury.

CAUTION:
Equipment damage may occur, but not personal injury.

Illustrations show the TM-71A.

FCC WARNING

This equipment generates or uses radio frequency energy. Changes or modifications to this equipment may cause harmful interference unless the modifications are expressly approved in the instruction manual. The user could lose the authority to operate this equipment if an unauthorized change or modification is made.

CONTENTS

1. BEFORE OPERATION	5	4-4 MEMORY	29
2. SPECIFICATIONS and ACCESSORIES	6	Microprocessor Memory Back-up	29
3. INSTALLATION INSTRUCTIONS	8	Microprocessor Initialization	29
4. OPERATION	12	Memory Channels	30
4-1 OPERATING CONTROLS	12	Memory Contents	30
Front Panel	12	Memory Entry	31
Microphone	16	Memory Channel Recall	32
Display Panel	18	Memory Banks	32
Rear Panel and Side case	20	Clearing Memory	35
4-2 RECEIVER OPERATION	21	Memory Shift	35
Receiver Operation	21	SCAN	36
Frequency Selection	22	Scan Options	36
Frequency Step Selection	22	Hold/Resume Programming	36
Programmable VFO Tuning Limits	23	Band Scan	37
A.B.C.(Automatic Band Change)	24	Programmable Band Scan	38
Band Selection	25	MHz Scan	38
Attenuator ON/OFF	25	Memory Channel Scan	38
ALT (Automatic Lock Tuning)	26	CALL Scan	39
4-3 TRANSMITTER OPERATION	27	V/M/C Scan	39
Transmission	27	Automatic Memory Scan	39
TX Alert	27	Memory Channel Lockout	40
Time-Out Timer (TOT)	28	REPEATER OPERATION	41
Bandwidth Selection	28	Transmitter Offset	41
		Reverse Function	41
		Tone and CTCSS Operation	41
		Autopatch Operations	43

4-7	DTSS	44
4-7	DTSS Code	44
4-7	DTSS Code Selection	44
4-7	Using the DTSS Function	45
4-8	Using DTSS with a Repeater	45
4-8	PAGING	46
4-8	Paging Code Memories	47
4-8	Code Selection	47
4-8	Code Transmission	48
4-8	Paging Code Monitoring	49
4-8	Code Lockout	50
4-9	-tone ALERT SYSTEM	51
4-10	AUTOMATIC POWER OFF (APO)	52
4-11	DIMMER (DIM)	52
4-12	BEEP TONE LEVEL ADJUSTMENT	53
4-13	BEEP TONE FREQUENCIES	53
4-14	KEY LOCKS	54
5	CLOCK	55
5-1	CURRENT TIME AND DATE	55
5-1	Backup Switch	55
5-1	Setting the Current Time and Date	55
5-2	OTHER CLOCK FUNCTIONS	56
5-2	Current Time, Calendar and Stopwatch in the Clock display	56
5-2	Time-ON/Time-Off Programming	57
5-2	Activating the SLEEP Timer	57
5-3	CLOCK POSITION ON THE FREQUENCY DISPLAY	58
5-3	Transceiver Function ON or OFF	58
5-3	Transceiver Function OFF	58
5-3	Transceiver Function ON	59
5-3	Tri-Bander	59
5-3	Clock Operation in the Frequency Display	60
6	MAINTENANCE	61
6	In Case of Difficulty	62
7	OPTIONAL ACCESSORIES	64
7	In Case of Difficulty	65
7	CTCSS unit (TSU-7)	65
7	DTMF unit (DTU-2)	65
7	Panel Separation Kit (PG-4K, PG-4L)	68
7	Bracket	70
7	Band Unit	71
7	BLOCK DIAGRAM and SCHEMATIC DIAGRAM	71
7 another sheet	71

NOTICE
 One additional band may be installed using options described in this manual. Operation instructions remain the same for the radio when uses a dual band or tri-band configuration.

T R A N S M I T T E R	Output Power	UT-28S		UT-30S		UT-1200	
		HI	MID	LOW	HI	MID	LOW
			50W	10W			10W
			Approx. 5W				1W
	Modulation	Resistance modulation					
	Spurious radiation	Less than -60dB(*)					
	Maximum frequency deviation	±3kHz					
	Audio distortion (at 60% modulation)	Less than 3%					
	Microphone Impedance	600Ω					
	Circuitry	Double conversion superheterodyne					
	Intermediate frequency 1st/2nd	8.83MHz		10.85MHz		9.7MHz	
	Sensitivity (12 dB SINAD)	Less than 0.1µV (-16dBµ)					
	Selectivity -6dB	More than 10kHz		More than 12kHz		More than 12kHz	
	Selectivity -60dB	Less than 24kHz		Less than 24kHz		Less than 36kHz	
	Squelch sensitivity	Less than 0.1µV (-20dBµ)		Less than 0.1µV (-20dBµ)		Less than 0.1µV (-20dBµ)	
	Output (5% distortion)	More than 2W/60 load)		More than 2W/60 load)		More than 2W/60 load)	
	External speaker impedance	8Ω					

NOTES: 1. Circuit and ratings are subject to change without notice, due to developments in technology.
 2. Recommended duty cycle: 1 minute Transmission, 3 minutes Reception.
 (*): HI Power position; Less than -70dB

4-2-7. Attenuator ON/OFF
(With the UT-28S/50S) See page 25.

4-2-8. AL T (Automatic Lock Tuning)
(With the UT-1200) See page 26.

4-3-4. Bandwidth Selection
(With the UT-28S) See page 28.

4-4-2. Microprocessor Initialization

band	28MHz	50MHz	1200MHz
VFO, Call and Memory channel 1 Frequency	29,000 MHz	51,000 MHz	1240,000 MHz
Frequency step	10kHz	10kHz	25kHz
Tone frequency	88.5Hz	88.5Hz	88.5Hz

4-1-1. 1MHz key (With the UT-28S except U.S.A. and Canada)

The chart below illustrates the way the displayed frequency will change when you increase or decrease the operating frequency in 1 MHz increment.
For ex. 29.6→28.1←(decrease) 29.1 (increase)→28.0

4-6-1. Transmitter Offsets

	28MHz band	50MHz band	1200MHz band
+	+ 100kHz	+ 1MHz	+ 12MHz
-	- 100kHz	- 1MHz	- 12MHz
--	--	--	- 20MHz

7-6-5. Specifications

	UT-28S 28 ~ 29.7	UT-50S 50 ~ 54 F3(FV) 50Ω	UT-1200 1240 ~ 1300
G	Frequency range		
E	Mode		
N	Antenna impedance		
E	Operating temperature		
R	Power requirements		
A	Ground		
L	Frequency stability		
	Current drain		
		Transmit mode	
		Receiver mode	

1. BEFORE OPERATION

To prevent electric shock, fire and other injury, please note the following:

Never remove the case unless instructed to do in this Instruction Manual. If the internal parts are touched accidentally, a serious electric shock might occur.

Do not place this unit where it will be exposed to direct sunlight or close to heating appliances.

Do not place anything on top of the cabinet.

To ensure good ventilation, do not put anything on top of the cabinet and allow at least 15 cm (6 inches) of space behind the unit.

The power requirement is 13.8 VDC. Never attempt connection to a 24 VDC source.

Do not place the unit in areas of excessive dust, high humidity or on unstable surfaces.

Do not drop pieces of metal, needles, coins and other electrically conductive materials into the unit.

Do not touch the power plug, when your hands are wet.

If an abnormal odor or smoke is detected, immediately turn the power off. Contact the KENWOOD service station or your dealer.

Cleaning

1. Turn the power off before cleaning the unit.
2. Do not use any type of abrasive pad, thinner, benzine or any substances which may damage the unit.
3. Wipe the front panel and other exterior surfaces of the unit with a soft dry cloth or a soft cloth lightly moistened with water.

2. SPECIFICATIONS and ACCESSORIES

2-1. SPECIFICATIONS

	144 MHz Band		220 MHz Band		440/430 MHz Band	
	USA and Canada	Other markets	144 ~148	220 ~225	438 ~450	430 ~440
Frequency range	144 ~148	144 ~148	144 ~148	220 ~225	438 ~450	430 ~440
Mode	FM	FM	FM	FM	FM	FM
Antenna Impedance	50Ω	50Ω	50Ω	50Ω	50Ω	50Ω
Operating temperature	-20°C ~ +60°C (-4°F ~ +140°F)					
Power requirements	13.8VDC ± 15% (1.17 ~ 15.8V)					
Ground	Negative					
Current drain	Transmit mode	Less than 11.5A	Receiver mode	Less than 1.0A	Less than 10.0A	
Frequency stability	± 10ppm					
Dimensions (W×H×D)	150×50×175 mm					
Weight	1.6 kg					
Output power	HI	50W	MID	25W	LOW	35W
	Approx. 5W					
	Reactance modulation					
Modulation	Reactance modulation					
Spurious radiation	Less than -60dB					
Maximum frequency deviation	± 5kHz					
Audio distortion (at 60% modulation)	Less than 3%					
Microphone impedance	600Ω					

3. To activate the optional band unit, reset the memory for the band.

1. Turn the POWER switch OFF.
2. Press and hold the F key and the BAND SEL key for the band, then turn ON the POWER switch. After 1 second all the indicators for the band will light.

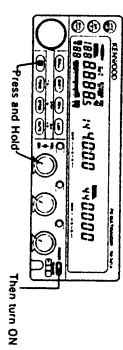

Then turn ON

3. Confirm the indicators, then release the F key and the BAND SEL key. The initial settings will be displayed, the PTT indicator will flash three times, and a beep will sound, then the memory reset will be finished.

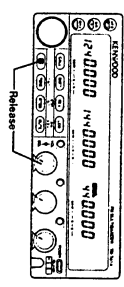

7-6-4. Additional Band Unit Functions
Instructions for the Tri-bander are the same as the instructions for Dual bander.

Optional band unit will add the following functions to the transceiver.

4-2-3. Frequency step selection

Use conventional labeling in charts. ○ = YES, × = NO.

Step Size [kHz]	5 \pm	10 \pm	15 \pm	20 \pm	12.5 \pm	25 \pm
28MHz band	○	○	○	○	○	○
50MHz band	○	○	○	○	×	○
220MHz band	○	○	○	○	○	○
1200MHz band	×	○	×	○	○	○

4-2-3. Frequency Step Selection

In the 28MHz band and the 50MHz band, the frequency step size will not adjust to it's original step size.

4-2-4. Programmable VFO Tuning Limits

In 28MHz band, the Programmable VFO Tuning limit is 100kHz.

The clock can be displayed in a frequency position (See page 58).

7-6-2. Notes

After installation the following parts will be remained.
Terminal plate
2 screws for bracket



A bracket

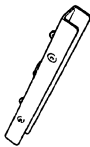

If you have some other number of parts or types of parts re-check your installation BEFORE TURNING the POWER switch ON.

7-6-3. Preliminally arrangement

We recommend the use of a DC power supply when checking the following points.

1. Connect the DC power cable.
2. Turn the POWER switch ON.
If there is no frequency in the display, disconnect the DC power cable immediately. Then check the following (a,b, and c).
 - a. Make sure the positive (+) and negative (-) lead polarity is correct when connecting the cable.
 - b. Check the cable connecting the front panel unit and the main unit.

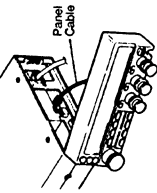

- c. Check fuse.
If the fuse opens be sure to check that each conductor has not been damaged by short circuiting, etc. Then replace with a new fuse of the same rating.

Only when a frequency display appears about a second after the -ON- indicator, proceed with the next step.

	144 MHz Band	220 MHz Band	440/430 MHz Band
R	Circuitry	Double conversion superheterodyne	
E	Intermediate frequency (st/nd)	30.925 MHz/455 kHz	21.6 MHz/455 kHz
C	Sensitivity (12 dB SINAD)	Less than 0.16 μV (-10 dBμ) *	
E	Selectivity -6dB	More than 12 kHz	
I	Selectivity -60 dB	Less than 24 kHz	
V	Squelch sensitivity	Less than 0.1 μV (-14 dBμ)	
E	Output (5% distortion)	More than 2 W (8Ω load) >5% distortion	
R	External speaker impedance	8Ω	

NOTE:1. Circuit and ratings are subject to change without notice, due to developments in technology.
2. Recommended duty-cycle: 1 minute Transmission, 3 minutes Reception.

2-2. ACCESSORIES

Unpack your transceiver carefully and confirm that the accessories listed below are included in the box.

- DTMF Microphone T91-0397-XX 1
- (U.S.A. and Canada only)
- or Microphone T91-0398-XX 1
- (European version)
- or Microphone T91-0396-XX 1
- (General market)
- Microphone Hook J20-0319-XX 1
- (U.S.A. and Canada only)
- Mobile Mounting Kit J29-0454-XX 1
- Bracket N99-0331-XX
- Screw set N99-0331-XX

- Self tapping Screw N46-3010-46 2
- (U.S.A. and Canada only)
- Hex Wrench W01-0414-XX 1
- DC power Cable E30-3034-XX 1
- Fuse (15A) F05-1531-XX 1
- Instruction Manual B62-0082-XX 1 copy
- Quick reference B59-0441-XX 1 copy
- Warning sheet B58-1001-XX 1 copy
- Warranty Card (U.S.A., Canada and European version only) 1
- After unpacking

Shipping container: Save the boxes and packing in the event your unit needs to be transported for remote operation, maintenance, or service.

3. INSTALLATION INSTRUCTIONS

3-1. INSTALLATION

3-1-1. Installing the Microphone and Setting the Clock Backup Switch

Before installing be sure to turn off the power switch.

1. Slide the release button on the front panel to the right. Carefully pull the front panel toward you from the right, then remove the whole panel unit. Be careful with the cord connecting the front panel unit to the chassis. (Fig. 1)
2. Insert the microphone connector into the microphone socket on the right of the main unit until it clicks. Make sure the tab on the connector is on top.
3. Place the microphone cord in the holder groove. (Fig. 2)

■ BACKUP SWITCH

Inside the small cover of the front panel unit there is a Backup Switch to retain clock memory. If you set the switch ON, turning off the POWER switch, disconnecting the power cable or an intermittent power failure will not erase the clock memories.

4. Slide the small cover off of the front panel unit as shown in the accompanying illustration. (Fig. 3)
5. Gently lift up on the cable near the grommet.
6. Set the Backup switch ON. Pay attention to the labelings.
7. Push the grommet down into its slot.
8. Replace the small cover until it clicks.
9. Route the cable as desired in the slots on the rear of the front panel.

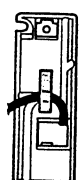

10. Align the hook on the back of the front panel with the slot on the left of the chassis before replacing the front panel.
11. Push the front panel toward the chassis until it locks completely. Take care not to trap the connecting cord.
12. Set the date and time (See page 55).

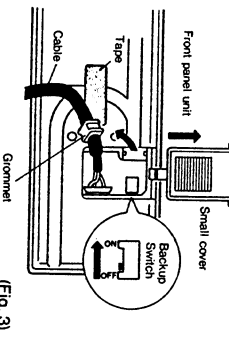
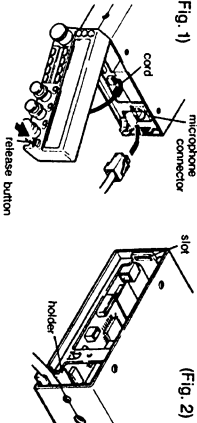

⑥ Tighten the new band unit.

- ① Tighten the 2 side screws to secure the new band unit in place.
- ② Insert the 2 long screws.
- ③ Tighten the 2 long screws while holding the nuts and lock rings from the opposite side.

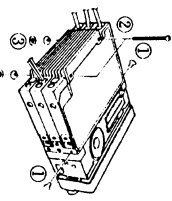

⑧ Replace the cooling fan assembly.

- ① Align the fan cable with the slot of the rear case.
- ② Replace the cooling fan assembly.
- ③ Tighten the 4 screws.

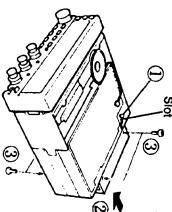

⑨ Attach the connector.

- ① Attach the connector.
- ② Route the cable in the slot of the chassis.
- ③ Attach the supplied 2 sheet on the cable.

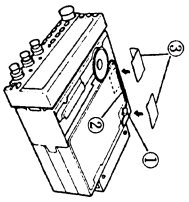

⑩ Replace the cases.

- ① Attach the top and bottom case.
- ② Tighten the 4 screws to secure the top case.
- ③ Tighten the 4 screws to secure the bottom case.
- ④ Tighten the 4 screws of the both sides.

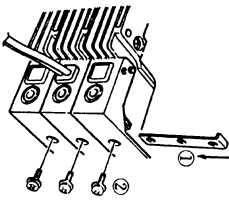

⑦ Attach the 3 unit terminal plate.

- ① Insert the 3 unit terminal plate.
- ② Tighten the 6 screws from each side of the 3 units.

②. Remove the cooling fan assembly.

- ① Disconnect the connector.
- ② Remove the 4 screws securing the fan case.
- ③ Remove the fan case.

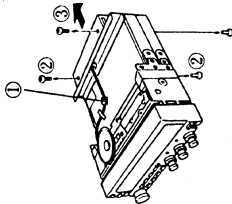

③. Remove the spacer.

- ① Remove the 2 long screws securing the spacer.
- ② Remove the spacer.

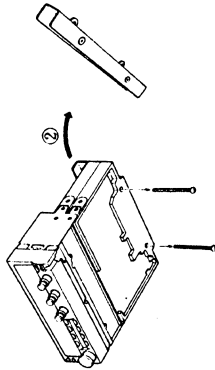

④. Be sure to unplug the dc cable before removing the terminal plate.

- ① Remove the 4 screws from the both sides of the present 2 units.
- ② Remove the plate.

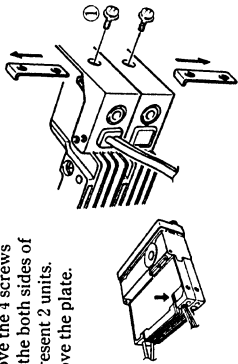

⑤. Insert the new band unit.

- ① Insert the new band unit as shown in the accompanying diagram.

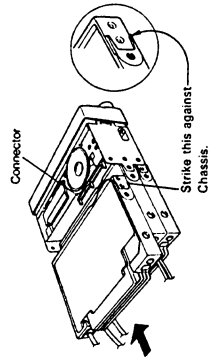

3-1-2. Mounting Bracket

Notes

1. When installing the transceiver in a vehicle consider ease of operation and safety when selecting the location for the mounting bracket.
2. Install the bracket securely so that it will not come off due to vibration.

1. Install the bracket using the supplied flat washers and self tapping screws (4 pcs. each).
2. Attach the transceiver loosely using the SEMS screws (4 pcs.).

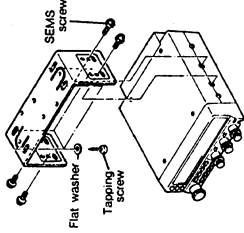

3. Adjust the viewing angle of the bracket to the desired position.



4. Hold the transceiver in place and tighten the 4 SEMS screws using the supplied wrench.

3-2. CONNECTION

3-2-1. Antenna

The type of antenna that is used will greatly affect the performance of the transceiver. Use a properly adjusted antenna, of good quality, to enable your transceiver to perform at its best. The antenna input impedance is 50 ohms. Use 50-ohm coaxial cable such as RG-8U or 8D-2V for this connection. If the antenna is far from the transceiver the use of low loss coaxial cable, such as RG-8U is recommended. Match the impedance of the coaxial cable and that of the antenna so that the SWR is less than 1.5 to 1. The protection circuit in the transceiver will activate if the SWR is particularly poor (greater than 3 to 1).

High SWR values will cause the transmitter output to drop, and may lead to TVI or BCI reports.

Caution :

We recommend that you install a high quality lightning arrester in your antenna lines for protection against fire, electric shock, personal injury, or damage to the radio itself.

3-2-2. Mobile Installations

- Cautions**
1. Before installing the power cable, be sure to remove the negative lead from the battery for safety.
 2. After installation and wiring, be sure to double check for correct installation before reconnecting the negative lead to the battery terminal.
 3. If the fuse opens, be sure to check that each conductor has not been damaged by short circuiting, etc. Then replace with a new fuse of the same rating.
 4. After completing the wiring, wrap the fuse holder with heat resistant tape to protect against heat and moisture.
 5. Do not remove the fuse even if the power cable is too long.

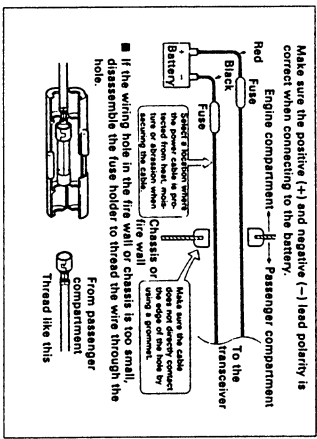

10

Battery Connections

Caution
Leave enough space around the fan on the rear panel for good ventilation.

Connect the power cable directly to the battery terminals. Use of the cigarette lighter socket will lead to poor connection, and will result in poor performance. Pay close attention to the polarity of the cables when connecting them to the battery.

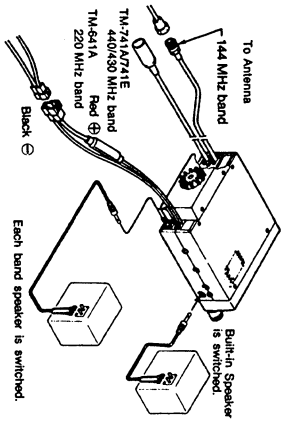

Caution
When not using the POWER switch of this set to turn the power on or off, be sure to set the BACKUP switch (on page 8) to ON. If you turn on the POWER switch with the BACKUP switch set to OFF, the indicator may not light.

7-6 BAND UNITS

Any of the following optional band units may be installed in the TM-741A/741E.
The same instructions apply for the Tri-Bander as for the Dual-bander.

	OPTIONAL BAND UNIT
TM-641A	UT-28S UT-50S UT-440S UT-1200
TM-741A U.S.A. version	UT-28S UT-50S UT-220S UT-1200
TM-741A	UT-28S UT-50S UT-1200
TM-741E	UT-28S UT-50S UT-1200

7-6-1. Installation

CAUTION
Before installing any band unit be sure to unplug the DC power cable.

- TOOLS:**
- 2.6mm Phillips screwdriver
 - 3.0mm Phillips screwdriver

① Remove the cases.

- ① Loosen the 4 screws on the top and bottom cover.
- ② Remove the 4 screws securing the top case.
- ③ Remove the 4 screws securing the bottom case.
- ④ Remove the top and bottom case.

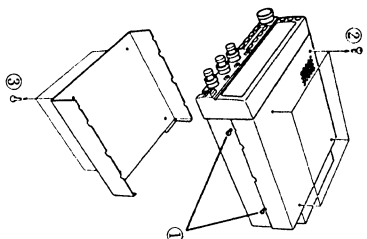

7-5. BRACKET

Loosen the bracket screws and put the two plates at right angles. Attach the front panel unit to the bracket using the three supplied screws. Install the bracket using the supplied flat washers and screws.

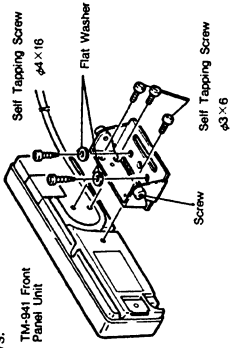

● Installation Using Velcro Fastener

NOTE
The bracket may come off due to vibration or shock when installed using Velcro. Install the assembly in a safe position near the console, or storage compartment (indicated by the lines) to ensure safety.

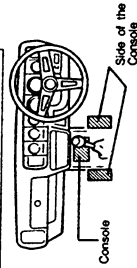

Peel the backing on the supplied Velcro tape and attach it to the back of the front panel unit. Securely install the front panel in a stable position.

70

3-2-3. Fixed Station

A regulated DC power supply (13.8 VDC capable of supplying at least 12 Amperes) is required. The PS-430 and the PS-50 are recommended.

Caution :

1. Never connect the AC power cable to the AC outlet until all other connections have been made.
2. Before connecting and disconnecting the power connector, be sure to turn OFF the POWER switches of both the transceiver and the DC power supply.
3. Observe polarity of the DC power cable. The transceiver operates on 13.8 VDC, negative ground. Battery polarity must be correct. The power cable is color coded:
Red → + (Positive polarity)
Black → - (Negative polarity)

Caution :
Leave enough space around the fan on the rear panel for good ventilation.

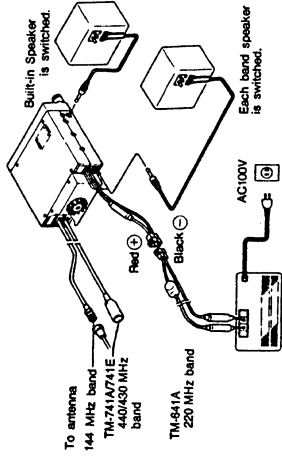

11

4. OPERATION

4-1. OPERATING CONTROLS

4-1-1. Front Panel

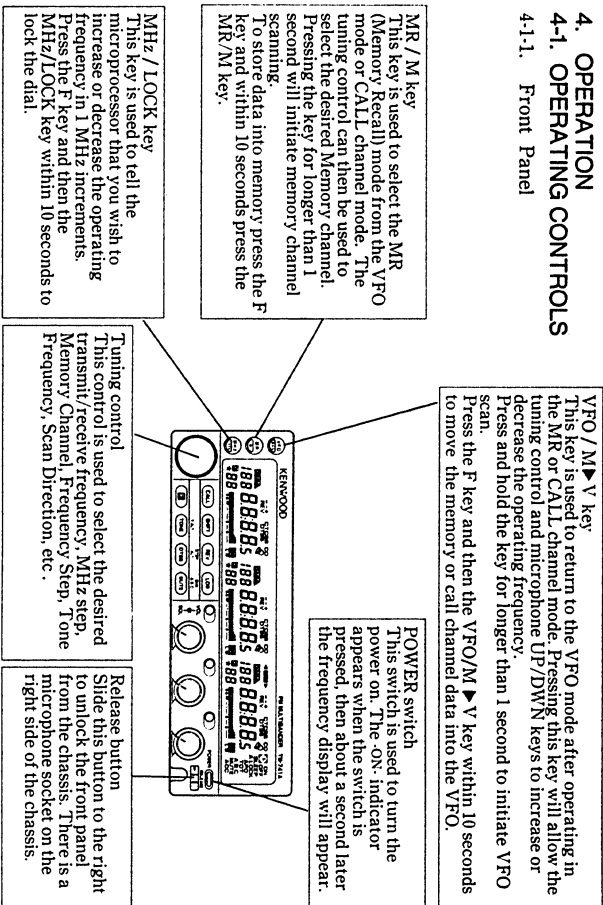

12

4. Remove the cover on the front of the PG-4K/4L front panel, and pass the microphone cable and front panel cable through the opening. (Fig. 4)

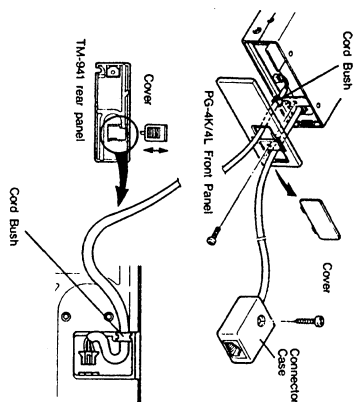

Fig. 4

5. Connect the PG-4K/4L microphone cable to the microphone connector. Push the connectors together until they click. (Fig. 4)

6. Attach the PG-4K/4L front panel to the transceiver with a binding screw and replace the cover. (Fig. 4)

7. Fit the cord bushing on the panel cable into the front panel (Fig. 5-D), fix the panel cable, and install the cover. (Fig. 4-A)

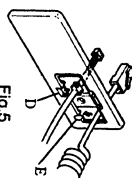

Fig. 5

8. Connect the microphone to the other connector of the microphone cable. Attach the connector in any convenient position with a screw.

9. Slide the small cover off of the front panel unit as shown in the accompanying illustration. (Fig. 4-B) Gently lift up on the cable near the grommet to disengage it from the front panel. Then gently pull the cable assembly to left to disconnect the white 4 pin connector. Push the white connector on the PG-4K/4L to right into the front panel socket.

NOTE:
The key on the connector should be up, as shown.

Push the grommet down into its slot, and route the cable as desired in the slots on the rear of the front panel. Replace the cover to complete the cabling. (Fig. 4-C)

69

7-4. PANEL SEPARATION KIT (PG-4K/4L)

PG-4K

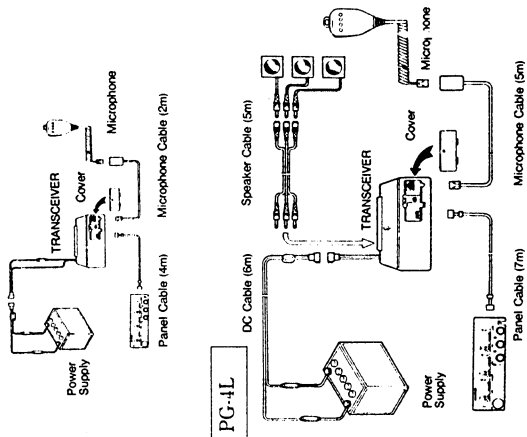

- Slide the release button on the front panel to the right. Pull the front panel unit toward you from the right, then remove the whole panel unit. Be careful with the cord connecting the front panel unit and the main unit. (Fig. 1)

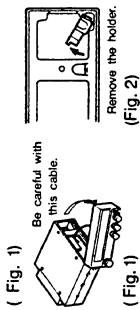

(Fig. 1)

- Unplug the microphone from the main unit, and remove the black plastic cord holder by pushing up on the front. (Fig. 2)

- Unplug the front panel cord connected to the transceiver main unit and connect the PG-4K/4L front panel cable to the transceiver.

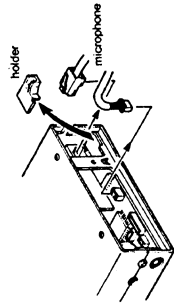

(Fig. 2)

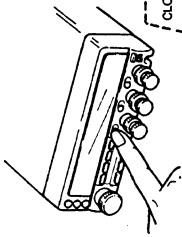

When optional band unit is installed.

CONTROL SELECT keys (Press) / Current Operating Band indicators

These keys are used to select the key operating band. (To change the transmission band, use the BAND SELECT key.) The green light shows which band will be controlled by the front panel controls.

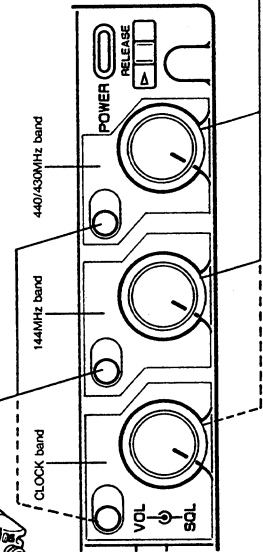

SQL (Squelch) controls
These controls are used to separately adjust each squelch threshold level.

BAND SELECT keys (Press) / VOL controls (Rotate)

These keys are used to select the transmit band. They are also used to select the band you wish to control with the front panel switches. When a key is pressed the "P.T.T." indicator will flash as a visual signal to show which band has been selected.

VOL controls (Rotate)

These controls are used to adjust the volume.

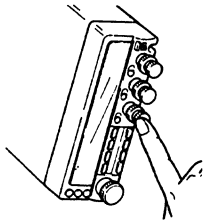

CALL key
Press this key to activate the call channel function. Pressing this key for longer than 1 second will initiate VFO/CALL or MEMO/CALL scan.

Pressing the F key momentarily and then pressing this key will store the currently displayed data into the Call channel.

SHIFT key
Pressing this key will cause the radio to shift from one offset direction to the other, i.e. "+" to "-", "-" to "+", to simplify where no indicator shows. ("—" to "+" for European version)

REV / STEP key
This key is used to reverse the transmit/receive frequencies during repeater operations. If you have selected simplex this key will not function.

Pressing the F key momentarily and then pressing this key will allow you to select the desired VFO tuning step and scan step size. Use the tuning control to select the desired tuning step.

LOW / DIM key
This key is used to select the transmit output power level.

Pressing the F key momentarily and then pressing this key will allow you to select the desired display intensity control. Four intensity selections are possible.

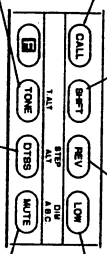

TONE / T.ALT key
Pressing this key causes the radio to select the desired tone signaling mode(T, CTCSS, OPF).

Pressing the F key momentarily and then pressing this key will activate the T.ALT function.

DTSS key
A unique audio tone has been programmed for each key. The tone will sound whenever a key is pressed.

With Optional DTU-2; Pressing this key selects the desired tone signaling mode (DTSS, Paging, or off).

MUTE / ABC key
This key is used to lower the receive audio level by -20dB.

Pressing the F key momentarily and then pressing this key will toggle the ABC function on or off.

7-3.3. DTMF Memory

With the optional DTMF unit DTU-2, DTMF telephone numbers can be stored into memory.

- Storing the DTMF codes
1. Press and hold the F key and the CALL key, then turn the POWER switch ON to select the DTMF code entry mode.

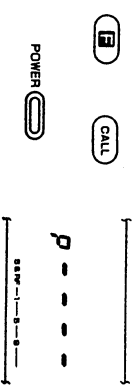

- Recalling stored DTMF code in receive mode
1. Press and hold the F key and the CALL key, then turn the POWER switch ON to select the DTMF code entry mode.
 2. Press the MR key on the microphone.
 3. Press the numeric key (0~9) that corresponds to the desired DTMF memory channel.
 4. The code are displayed as shown.

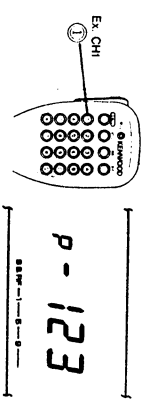

■ Making a DTMF Call

1. Press the BAND SEL key to equalize TX band and RX band.
 2. Press the PF key while holding the PTT switch down then press the numeric key that corresponds to the desired DTMF memory channel.
- The DTMF code is output. The display shows the code.

NOTES
Transmission continues until the whole code string is recalled even if the PTT switch is released.

■ With the optional DTU-2 DTMF unit is installed, the DTSS key functions the signaling mode selection key. We recommend that to perform the microphone PF key to program the Tone Representation function. See page 53 BEEP TONE FREQUENCIES

7-3-2. Frequency Entry with DTMF Microphone

With the optional DTMF unit DTU-2, the DTMF microphone(*) provides direct keyboard frequency entry.

1. Press and hold the F key and the VFO key, then turn the Power switch on. The MC-15DM microphone PF key will perform the keyboard entry function.

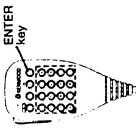

2. Press the ENTER (PF) key to select the ENTRY mode. The digits to be entered will change "...".

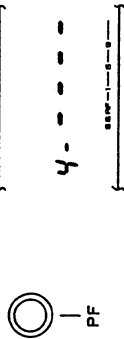

3. Within 10 second of pressing the ENTER (PF) key press the desired frequency from the most significant digit. After the least significant digit has been entered the transceiver changes frequency.

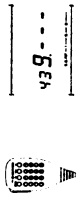

Pressing the ENTER key before the frequency is completely entered will cause the remaining digits (...) to return to their previous settings.

Pressing any key other than the ENTER key or NUMERIC keys before the frequency is completely entered will cause the entire frequency to return to the previous setting.

(*) DTMF microphone; Supplied with U.S.A. and Canadian version or Optional MC-15DM

In 12.5 kHz or 25 kHz step size direct frequency selection will be completed in the 10 kHz digit. When you enter the following keys for the 10 kHz digit, 1 kHz and 100 Hz digit frequencies are automatically selected from the list below.

10 kHz digit	Frequency kHz	10 kHz digit	Frequency kHz
0	00	5	50
1	12.5	6	62.5
2	25	7	75
3	37.5	8	87.5
4	37.5	9	87.5

■ Function key Assignments

- Press the F key for longer than 1 second so that the key indicator begins to flash, then press the key below.

Key	Function	Refer to
F 1 Sec. VFO	Change Scan Hold/Resume mode	P.36 4-5-2
F 1 Sec. MR	Memory channel lockout	P.40 4-5-10
F 1 Sec. MHz	Automatic Power off function will turn on or off	P.52 4-10
F 1 Sec. CALL	The lower limit of the programmable VFO	P.23 4-2-4
F 1 Sec. SHIFT	The upper limit of the programmable VFO	P.23 4-2-4
F 1 Sec. TONE	Tone frequency selection	P.42 4-6-3
F 1 Sec. REV	Beep tone level adjustment	P.53 4-12
F 1 Sec. DTSS	DTSS code selection	P.44 4-7-2
F 1 Sec. LOW	Time-out timer on or off	P.28 4-3-3
F 1 Sec. CONT SEL	Select receive detection output band from the microphone connector	P.18 4-1
F 1 Sec. BAND SEL	Band on or off	P.25 4-2-6

- Press and hold the F key, then the key below.

Key	Function	Refer to
F+ VFO	Enter the programmable scan lower frequency limit	P.38 4-5-4
F+ MHz	Enter the programmable scan upper frequency limit	P.38 4-5-4
F+ MR	Clear the displayed memory channel data	P.35 4-4-8
F+ TONE	Bank status display	P.32 4-4-7
F+ DTSS	DTSS delay time selection	P.45 4-7-4
F+ LOW	Memory consolidation	P.32 4-4-7
F+ CONT SEL	Automatic Memory scan	P.39 4-5-9
F+ BAND SEL	Clear Memory Bank	P.35 4-4-8
F+ PTT	T.X. Alert	P.27 4-3-2

- Press and hold the key below and turn on the power switch.

Key	Function	Refer to
MR+	Memory reset of all bands	P.29 4-4-2
F+BAND SEL +Power ON	Memory reset of a band	P.29 4-4-2

Key	Function	Refer to
VFO+ Power ON	VFO reset of all bands	P.30 4-4-2
VFO-BAND SEL + Power ON	VFO reset of a band	P.30 4-4-2
MHZ+ Power ON	All lock on or off during Lock	P.54 4-1-1
CALL+ Power ON	Demonstration mode on or off	P.40
F-SHIFT+ Power ON	Tone alert selection	P.51 4-9
F-TONE+ Power ON	Set the time and date	P.55 5-1-2
F-DTSS+ Power ON	With optional DTU-2: The microphone PF key can be used to change the beep tone frequency.	P.66 7-3-1
F+LOW+ Power ON	Wide /Narrow selection	P.28 4-3-4

4-1-2. Microphone

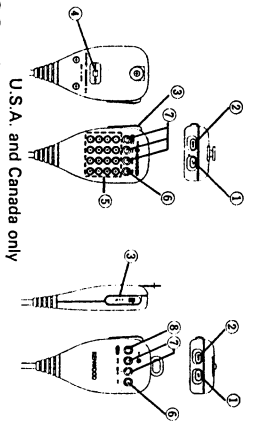

- ①②UP/DWN switches
These switches can be used to increase or decrease the VFO frequency, the Memory channel number, and the Tone frequency, etc..
- ③PTT (Push to Talk) switch
The transceiver will transmit whenever this switch is depressed. Scan operations may be canceled by pressing this switch without transmitting.
- ④LOCK switch
This key will deactivate all functions of the microphone except the PTT function and DTMF keypad.
- ⑤16-Tone DTMF keypad
These buttons are used to activate the DTMF encoder.

INSTALLING OPTIONAL ACCESSORIES

CAUTION
Before installation, be sure to disconnect the DC power supply, or damage may occur to the equipment.

7-2. CTCSS UNIT (TSU-7)

1. Slide the release button on the front panel to the right. Pull the front panel toward you from the right, then remove the whole panel unit. Be careful with the cord connecting the front panel unit to the main unit. (Fig. 1)
2. Remove the backing from the cushion provided with the TSU-7 and attach it to the back of the TSU-7 as shown in Fig. 3.
3. Remove the backing from the other side of the small cushion. (Fig. 3)
4. Insert the CTCSS connector directly into the TSU-7 connector on the PC board, then gently push it down until it seats. (Fig. 3)
5. Replace the front panel back, taking care not to trap the connecting cord. The connecting cord is easier to manage when it is put in the groove on the back of the panel. (Fig. 2)

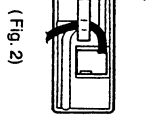
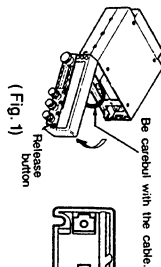

7-3. DTMF UNIT (DTU-2)



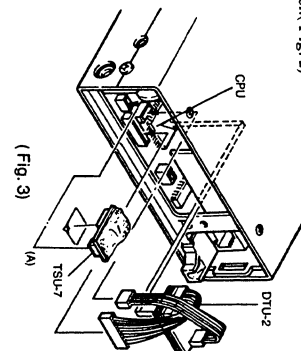

7-3-1. Installation

1. Slide the release button on the front panel to the right. Pull the front panel toward you from the right, then remove the whole panel unit. Be careful with the cord connecting the front panel unit and the main unit. (Fig. 1)
2. Remove the backing from the cushion provided with the DTU-2 and attach it to the back of the DTU-2 as shown in Fig. 3.
3. Use the cable supplied with the DTU-2 and attach the two connectors to the main unit. (Fig. 3)
4. Attach the DTMF unit to the main unit. (Fig. 3)
5. Replace the front panel back, taking care not to trap the connecting cord. The connecting cord is easier to manage when it is put in the groove on the back of the panel. (Fig. 2)

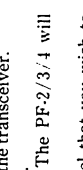
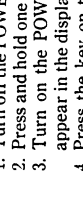
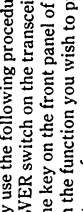
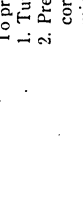

7. OPTIONAL ACCESSORIES

7-1. ACCESSORIES

<p>CTCSS UNIT TSU-7</p> 	<p>DTMF UNIT DTU-2</p> 	<p>MOBILE MOUNT BRACKET MB-11</p> 	<p>DETACHABLE FRONT PANEL KIT PG-4K</p> 	<p>DETACHABLE FRONT PANEL KIT PG-4L</p> 
<p>MULTI FUNCTION MICROPHONE MC-45/45E (European version)</p> 	<p>MULTI FUNCTION MICROPHONE WITH DTMF MC-45DM/45DMEPG-3G</p> 	<p>DC LINE NOISE FILTER PG-2N</p>	<p>BAND UNIT UT-28S UT-50S UT-220S (U.S.A. only) UT-440S (U.S.A. only) UT-1200</p>	<p>MICROPHONE PLUG ADAPTOR MJ-88</p>
<p>MULTI FUNCTION MICROPHONE MC-45/45E (European version)</p>	<p>COMMUNICATIONS SPEAKER SP-50B</p>	<p>DC POWER SUPPLY PS-430</p>	<p>DC POWER SUPPLY PS-50</p>	<p>MICROPHONE PLUG ADAPTOR MJ-88</p>
<p>MOBILE SPEAKER SP-41</p>	<p>COMMUNICATIONS SPEAKER SP-50B</p>	<p>DC POWER SUPPLY PS-430</p>	<p>DC POWER SUPPLY PS-50</p>	<p>MICROPHONE PLUG ADAPTOR MJ-88</p>

CALL key VFO key, MR key
These keys function are like the CALL, VFO, or MR key on the front of the radio. (See page 12 and page 14)
These keys can be programmed to function as the PF key. To program the key:

1. Turn off the POWER switch on the transceiver.
2. Press and hold one of these keys.
3. Turn on the POWER switch. The PF-2/3/4 will appear in the display.
4. Press the key on the front panel that you wish to program the microphone key.
5. Release the microphone key.

To release the programming reset the VFO.

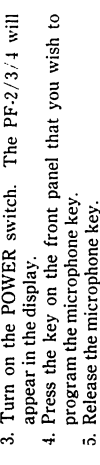

MR key PF2
MR key PF3
MR key PF4

Press and hold

Turn on

1750key (European version)

The transceiver will transmit with 1750 Hz repeater access tone whenever this switch is depressed.

PF (Programmable Function) key
This key can be programmed to perform any of the following functions: BAND SEL (*) key (initial setting from the factory); or MHz, T.ALT, TONE, REV, DTSS, LOW, MUTE, or CONT SEL (*) key.

To program the key use the following procedure:

1. Turn off the POWER switch on the transceiver.
2. Press and hold the key on the front panel of the set that corresponds with the function you wish to program the microphone key to perform.
3. Turn on the POWER switch while the key on the front panel is held in.
4. Release the front panel key.

(*) Press the PF key set in the CONT SEL or BAND SEL key to cause the radio to switch from a band to the other. Pressing the PF key for longer than 1 second will not initiate scanning.

Press the PF key set in the CONT SEL or BAND SEL key to cause the radio to switch from one band to the other. Pressing the PF key for longer than 1 second will not initiate scanning.

One additional function can be programmed that is not included on the front panel of the transceiver. This is known as the MONITOR function. This will allow you to open squelch of the selected band to check the band for a clear frequency. This will function even if you are operating in the CTCSS decode mode.

MONITOR programming
Press and hold the F key on the front panel as you turn on the POWER switch of the transceiver and then release the F key.

The MONITOR function is selected and canceled alternately each time this key is pressed. Be sure to cancel the monitor function before starting another operation.

● Microphone terminal connection

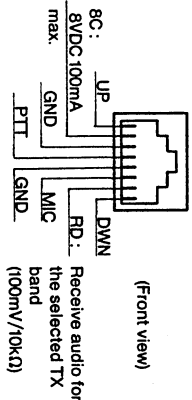

Receive Audio Output Band Selection (RD) connector

The RD terminal will supply an audio signal during receive on the same band that has been selected for transmit. Press the F key for longer than 1 second, and then press the CON'T SEL key for the desired band. An indicator will appear in the frequency display of the selected band.



Receive Audio output display
The 100 kHz dot in the band lights

4-1-3. Display Panel

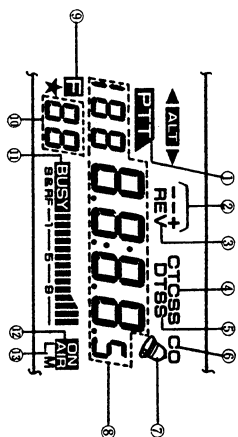

- ① **PTT** Indicates the TX band.
- ② **---** Displays the selected transmitter offset direction.
- ③ **REV** On when the Reverse function has been activated.
- ④ **CTCSS** With the optional CTCSS unit TSU-7: On when the Tone Decode function is active.
- ⑤ **DTSS** With optional DTU-2: On when the DTSS function is active.
- ⑥ **CO** On when the Carrier Operated scan is selected.
- ⑦ **🔊** On when the Tone Alert function is active.

Symptom	Probable cause	Corrective action
The display does not change when the tuning control is rotated.	<ol style="list-style-type: none"> The LOCK function is on. The ALL LOCK function is on. 	<ol style="list-style-type: none"> Press the F key, then press the MHz/LOCK key within 10 seconds. Hold down the MHz/LOCK key, switch the power on, then perform step 1 again.

Some dial frequency relationships may result in internal heterodyne tones being generated by the TM-641A/741A/741E. This is not a defect.

The following formulas may be used to determine if a tone will be present with a particular frequency relationship. If any of the following equations are true, a tone may be generated that is strong enough for you to hear it in the speaker of both bands. These tones can only be generated when more than one band is on at a time:

- With the optional FM unit UT-1200:
 - (1.2GHz operating frequency) - 59.7MHz × 2 - ((70CM operating frequency) + 21.6MHz) × 5 = 59.7 MHz
 - or
 - ((70CM operating frequency) + 21.6MHz) × 4 - (((1.2GHz operating frequency) - 59.7MHz) / 2) × 3 = 59.7 MHz
 - or
 - (1.2GHz operating frequency) - 59.7MHz × 2 - ((70CM operating frequency) + 21.6MHz) × 5 = 21.6 MHz
- For TM-741A/741E with the optional FM unit UT-220:
 - or
 - For TM-641A with the optional FM unit UT-440S:
 - ((220MHz operating frequency) - 30.825MHz) × 5 - ((70CM operating frequency) + 21.6MHz) × 2 = 30.825 MHz
 - With the optional FM unit UT-50S:
 - ((6M operating frequency) + 10.595MHz) × 7 - ((70CM operating frequency) + 21.6MHz) = 21.6 MHz

● IN CASE OF DIFFICULTY

The problems described in this table are failures caused, in general, by improper operation or connection of the transceiver, not by defective components. Examine and check according to the following table.

Symptom	Probable cause	Corrective action
Indicators do not light and no receiver noise is heard when the POWER switch is turned on. When not using the POWER switch of this set to turn the power on or off, check item 3. in the probable cause column.	1. Bad power cable or connections. 2. Blown power supply fuse. 3. The BACKUP switch for the front panel unit is set to OFF.	1. Check cables and connections. 2. Check for the cause of the blown fuse and replace the fuse. 3. The BACKUP switch for the front panel unit is set to ON.
No sound from the speaker. No signal can be received.	1. Squelch is closed. 2. With the TSU-7 ; CTCSS is operating.	1. Turn the SQL control counter-clockwise. 2. Press the TONE/T.ALT key to turn off the CTCSS.
No transmitter output.	1. Microphone jack is not plugged in. 2. Poor antenna connection.	1. Plug jack in. 2. Connect antenna securely.
Weak signal cannot be received.	Poor antenna connection.	Connect antenna securely.
Display is dark.	1. Power voltage is low. 2. DIM had been set too dark.	1. Check voltage for 13.8 VDC ± 15 %. 2. Press the F key and the LOW/DIM key. See page 52.
No memory back up.	Backup battery voltage is low.	See Microprocessor memory backup page 29
Clock is wrong.	Backup battery voltage is low. Backup switch is off.	Contact the authorized dealer. See memory backup page 8

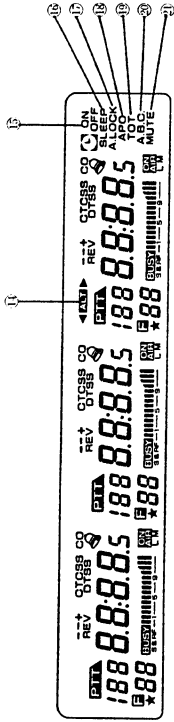

① **188 00:00.5** Displays the operating frequency to the nearest kHz digit, or the tone frequency. The indicator flashes when scanning.

② On when receive detection output is fixed in the band.

③ **F** On whenever the F key has been depressed.

④ ***88** Shows the last memory channel number that was selected. The ★ indicator is on when the Memory channel will be skipped during Memory channel scan.

⑤ **PB** On when the squelch opens.

⑥ This level meter indicates the relative receiver signal strength or the relative transmitter power output.

⑦ **ON/OFF** On during transmit.

⑧ **SLEEP** Indicates the relative output power setting for transmit. No indicator indicates full power.

⑨ **LOCK**

⑩ **A LOCK**

⑪ **APO**

⑫ **TOT**

⑬ **A.B.C.**

⑭ **MUTE**

① **1200MHz band only:** On when the Automatic Lock Tuning function is active.
② **28-50 MHz band only:** On when Attenuator is on.

③ On when the **TIME ON/OFF** function has been activated.

④ On when the **SLEEP TIMER** function has been activated.

⑤ On when the **Lock** function has been activated.

⑥ On when the **All Lock** function has been activated.

⑦ On when the **Automatic Power Off** function has been activated.

⑧ On when the **Time-Out Timer** function has been activated.

⑨ On when the **Automatic Band Change** function has been activated.

⑩ On when the volume of the **RX band** is reduced.

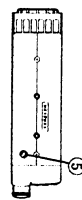
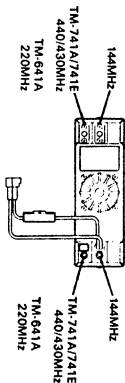

①ANTENNA connector
Attach an antenna with a low SWR and impedance of 50 ohms.

②13.8 VDC power input connector
Connect the supplied DC power cable to this connector. Pay close attention to the polarity. Red is positive and black is negative.

③Fuse holder
Contains a 15A fuse. Do not use a larger fuse as damage might result to the transceiver.

④External speaker jack (Rear panel)
The speaker should have an impedance of 8 ohms. The audio is switched to the external speaker (no sound is output from the built-in transceiver speaker).

Example

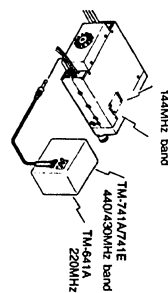

⑤External speaker jack (Side case)
The speaker should have an impedance of 8 ohms. The audio is switched from the built-in transceiver speaker to the external speaker (no sound is output from the built-in transceiver speaker).

Example

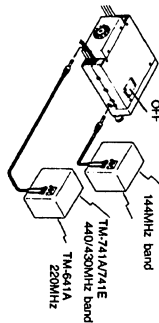

We recommend the use of the optional external speaker SP-50B.

6. MAINTENANCE

●GENERAL INFORMATION

Your transceiver has been factory aligned and tested to specification before shipment. Under normal circumstances the transceiver will operate in accordance with these operating instructions. All adjustable trimmers and coils in your transceiver has been adjusted at the factory and should only be readjusted by a qualified technician with proper test equipment. Attempting service or alignment without factory authorization can void the transceiver's warranty.

When operated properly, the transceiver will provide many years of service without requiring realignment. The information in this section gives some general service procedures which can be accomplished without sophisticated test equipment.

●SERVICE

Should it ever become necessary to return the equipment to your dealer or service center for repair, pack it in its original box and packing, and include a full description of the problems involved. Also include your telephone number. You need not return accessory items unless directly related to the service problem.

SERVICE NOTE:

Dear OM, if you desire to correspond on a technical or operational problem, please make your note short, complete, and to the point, and PLEASE make it readable.

Please list: Model and serial number.
The problem you are having.

Please give sufficient detail to diagnose. Information such as other equipment in the station, meter readings and anything else you feel might be useful in attempting diagnosis.

CAUTION:

Do not pack the equipment in crushed newspapers for shipment. Extensive damage may result during shipment.

NOTES:

1. Record the date of purchase, serial number and dealer from whom purchased.
2. For your own information, retain a written record of any maintenance performed on the unit.
3. When claiming warranty service, please include a photocopy of the bill of sale, or other proof of purchase showing the date of sale must accompany the transceiver.

4-2. RECEIVER OPERATION

4-2-1. Receiver Operation

1. Set the controls as follows:

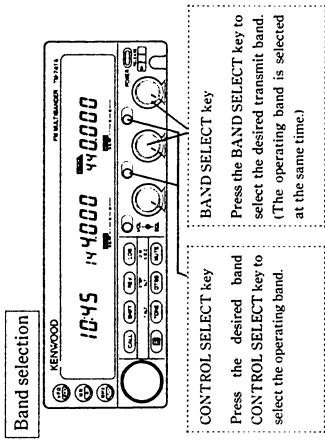

Fig.1

2. Turn on the Power Supply, then turn on the transceiver's POWER switch. The display should light after 1 second. Fig.1 shows examples of frequencies that will appear on the various models. The frequencies shown above are the default frequencies after a microprocessor reset. If the display shows incomplete data or you think the displayed frequency is in error you should reset the microprocessor. (Memory Initialization on page 29)

Perform the following steps for each band.

3. Press the desired band BAND SEL or CONT SEL key so that the operating band indicator lights (green). Rotate the VOL control clockwise until a signal or noise is heard coming from the speaker.
4. Rotate the tuning control or press the microphone UP/DWN switches to select an open channel.
5. Rotate the SQL control clockwise until the noise just disappears and the BUSY indicator turns off. This point is known as the Squelch Threshold point.
6. Select the desired operating frequency using the microphone or tuning control. When a signal is received the S-meter will deflect and the BUSY indicator will turn on.

5-3-5. Clock Operation in the Frequency Display

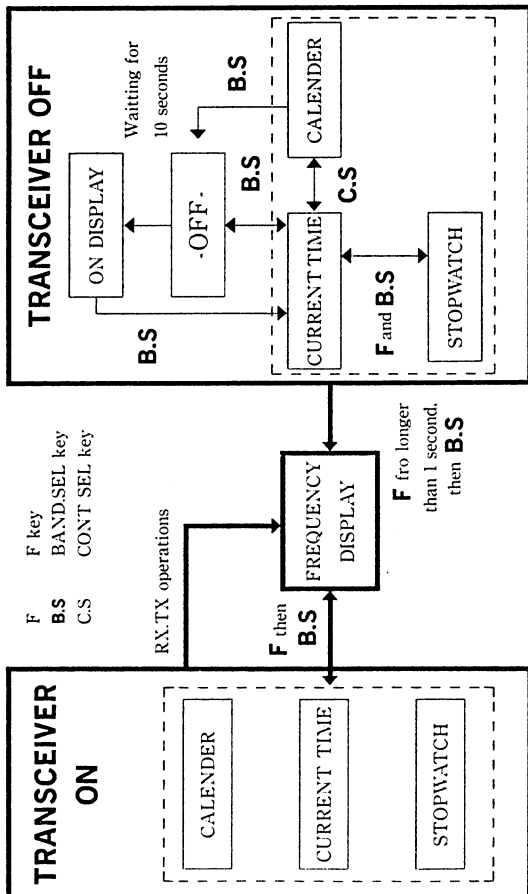

- Turn off the transceiver's Power switch before you turn off the power supply, or in a vehicle, before you stop the engine.

4-2-2. Frequency Selection

You can change the dial frequency while in the VFO mode. The frequency can also be stored in memory, or in the call channel.

- Press the VFO key to select the VFO mode.
- Rotate the tuning control, or press the microphone UP/DWN switches to select the desired frequency.

Mode selection

You can select the VFO mode, Memory channel mode, or Call channel mode using the following keys.

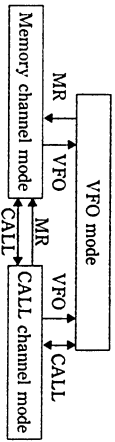

- Press the VFO key to select the VFO mode.
- Press the F key momentarily. The F indicator should light on the display.
- Press the REV/STEP key within 10 seconds of pressing the F key. The current frequency step size will be displayed.
- Rotate the Tuning control or press the microphone UP/DWN keys until the desired tuning step size appears in the display.

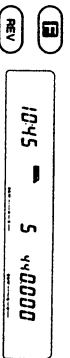

Step Size [kHz]
 $5 \approx 10 \approx 15 \approx 20 \approx 12.5 \approx 25 \approx$

- To complete the programming of the step size you can press any front panel key or simply wait 10 seconds and the microprocessor will automatically return to the normal frequency display.

When the F key is pressed for longer than 1 second, then the BAND SEL key for the last frequency band is pressed, the STOP WATCH will turn on or off.

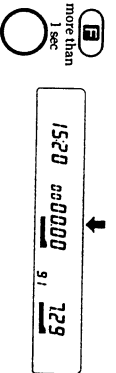

- Return to Frequency Display
 Press the F key for longer than 1 second then press the BAND SEL key for the band.

5-3-3. Transceiver Function ON

When the F key is pressed, then the BAND SEL key for a frequency band is pressed, the calendar display will turn on or off.

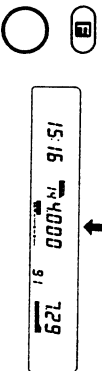

Each time the F key and then the BAND SEL key for the last frequency band is pressed the STOP WATCH will turn on or off.

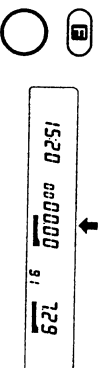

When the band in which the clock has been programmed is selected, the display will return to the frequency display by TX.

- Return to Frequency Display
 Press the F key then the BAND SEL key for the band.

If the clock is displayed while the transceiver is on, no settings (such as time change and stopwatch start) can be made.

5-3-4. Tri-Bander

Tri-bander with an optional BAND UNIT can be also change to a three simultaneous CLOCK DISPLAY at the same time.

5-3 CLOCK POSITION ON THE FREQUENCY DISPLAY

The transceiver is capable of displaying the clock in either the normal clock position or in the frequency display area.

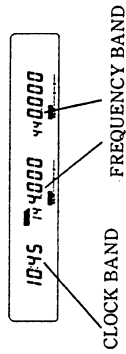

If you have programmed the radio to display two clock functions the display will be configured as shown in the accompanying diagram.

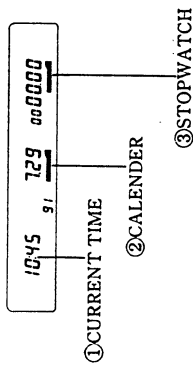

5-3-1. Transceiver Function ON or OFF

The clock can be displayed in a frequency position with the transceiver function either ON or OFF. The CONT SEL indicator will light to signal the transceiver function is ON.

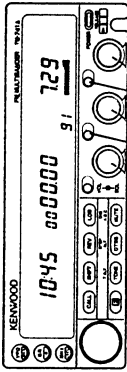

The CONT SEL indicator will light.

5-3-2. Transceiver Function OFF

Press the F key for longer than 1 second, then press the BAND SEL key for a frequency band. The frequency will turn off and calendar will turn on.

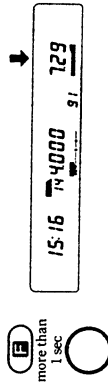

The chart below illustrates the way the displayed frequency will change when you change from one step size to another.

5.10,15,20 to 12.5,25	12.5,25 to 5.10,15,20
0	0
25	10
50	20
75	30
	40
	50
	60
	70
	80

For example:

Assume you are presently displaying a frequency of 439.920 MHz and had previously selected a 20 kHz step size. If you were to change the step size to 12.5 kHz the display would then read 439.925 MHz.

4-2-4. Programmable VFO Tuning Limits
The radio provides the capability of programming the VFO tuning range, in 1 MHz band segments, as well as providing a separate programmable band scan function. (See section 4-5.) For example, you could tell the transceiver that you only wish to tune the 438.000 MHz and 439.000 MHz band segment by specifying any frequency with these two segments. The Tuning controls would then only tune within these specific bands. The procedure for specifying the bands is described below.

1. Press the VFO key to select the VFO mode. Rotate the Tuning control until the desired lower tuning range appears on the frequency display. For example, you might want to select the 438 MHz band and dial up 438.100 MHz.
2. Press the F key, for longer than 1 second, then press the CALL key.

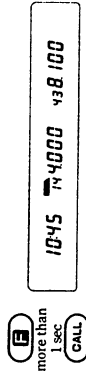

3. Rotate the Tuning control until the desired upper tuning range appears on the frequency display.
4. Press the F key for longer than 1 second, then press the SHIFT key.

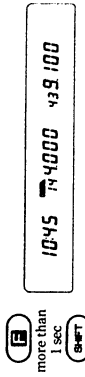

5. To confirm that the programming was properly performed rotate the Tuning control. The transceiver should not go above or below the programmed band limits.

6. To clear both programmed limits simultaneously, turn the Power off, then:

ALL BAND mode

Press and hold the VFO key, then turn the Power switch on (VFO RESET. See page 30).

INDIVIDUAL BAND mode

Press and hold the VFO key and the BAND SEL key for the band you want to clear, then turn the Power switch on. You can reprogram either limit independently by following the appropriate instructions above.

2. As soon as a signal is received on any band, the TX circuit will become active on that band.

10.45 MHz 4000 kHz 0000 ...

3. If you press the PTT switch,

The A.B.C. function will be released. The band remains TX band.

If the PTT switch is not pressed,

Within 2 seconds after the signal goes off, the band will be returned to RX band.

If you press the BAND SEL key,

The A.B.C. function will be released.

5-2-2 Time-ON/Time-Off programming

1. In the clock mode, press and hold the F key, then press the CONT SEL key. The ON indicator will flash.

ON

10.45

ON

2. Selecting the TIME-ON or TIME-OFF:

Within 10 seconds press the MUTTE key. The ON indicator will turn off then the OFF indicator will flash.

MUTTE

3. HOUR programming

Rotate the Tuning control (0~23) to set the HOUR, then press the TONE key.

TONE

4. MINUTE programming

Rotate the Tuning control (0~59) to set the MINUTE, then press the TONE key. The transmitter return to previous mode.

TONE

■ Activating the TIME ON function

Pressing the F key, then the BAND SEL key will turn the TIME ON function ON or OFF when you are in the time display mode.

ON

■ Activating the TIME OFF function

Pressing the F key, then the CONT SEL key will turn the TIME OFF function ON or OFF when you are in the time display mode.

OFF

5-2-3. Activating the SLEEP Timer

1. Press the F key for longer than 1 second then press the CONT SEL key while in the time display mode.
2. Rotate the Tuning control to select the desired delay period. The range is indicated in the chart below.
(minutes)

SLEEP

SLOFF--30--60--90--120--SLOFF

3. Select the desired range.
4. The previous display mode will be restored 10 seconds after the selection or when any key is pressed.

4-2-5. A.B.C.(Automatic Band Change)
The A.B.C function allows you to exchange the RX band to the TX band automatically, whenever a signal is received and the squelch is open.

1. Press the F key and then press the MUTTE/ABC key. The A.B.C. indicator will light on the display.

ABC
10.45 MHz 4000 kHz 0000 ...
 MUTTE

5-2. OTHER CLOCK FUNCTIONS

The transceiver has the following clock functions, as well as current time and calendar display.

1. **STOPWATCH**
Switches the transceiver ON at a set time every day.
2. **TIME ON SWITCH**
Switches the transceiver OFF at a set time every day.
3. **SLEEP TIMER**
The transceiver is automatically switched off after a set period.

5-2-1. Current Time, Calendar, and Stopwatch in the Clock Display

Press the BAND SEL key of the clock band to display or erase the CURRENT TIME.
When the current time is displayed, pressing the CONT SEL key for the clock band will display or erase the CALENDER.
Pressing and holding the F key then pressing the BAND SEL key will display or erase the STOPWATCH.

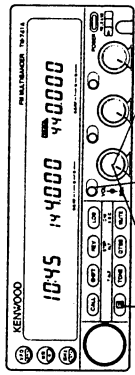

STOPWATCH CURRENT TIME CALENDER

■ Stopwatch

Pressing the BAND SEL key will start/stop the stopwatch.
Pressing the CONT SEL key will reset the stopwatch to 0:00.

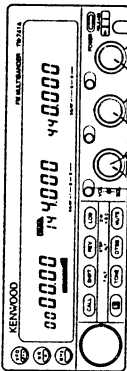

Reset

Start/Stop

4-2-6. Band Selection

1. Press the F key for longer than 1 second. The F indicator will begin to flash.
Press the BAND SEL key for the bands you wish to turn on/off. A Calender will be displayed.

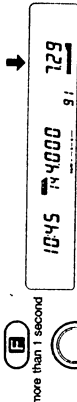

2. Press the BAND SEL key again.
When turning off a band an "off" will be displayed in the display for approximately 10 seconds then the appropriate band display will come back.

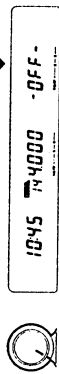

3. To return to the previous display press the F key for longer than 1 second then press the BAND SEL key. It is possible to turn off all three bands. In this case no frequencies will be displayed.

4-2-7. Attenuator ON/OFF (Requires optional BAND UNIT UT-28S or UT-50S)

When the incoming signal is very strong, the signal should be attenuated to prevent distortion of the signal, thereby stabilizing the receiver performance.

1. Press the CONT SEL key or the BAND SEL key for the 28/50MHz band.
2. Pressing the F key momentarily then pressing the DTSS key will toggle the ATTENUATOR function on or off. The attenuator indicator will turn on when the function is active.



4-2-8. **ALT (Automatic Lock Tuning)**
(Requires optional BAND UNIT UT-1200)

The ALT system operates similar to an AFC (Automatic Frequency Control) system. This system is useful when the frequency of either station starts to drift. When this occurs distortion of the signal is the usual result. The ALT system will detect the drift and shift the frequency to compensate.

1. Press the F key momentarily. The F indicator will light on the display.
2. While the F indicator is on press the DTSS/ALT key. The ALT indicator will turn on and the receiver will automatically center itself on the incoming signal.

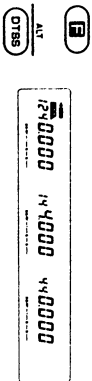

3. To release the ALT function press the F key momentarily, then press the DTSS/ALT key again.

The frequency display will not actually change, even though the receive frequency might shift in order to properly tune the incoming signal. When the ALT system is operating the direction indicator in the display will turn on to signal a change in the receiver frequency. The direction indicator will show you if the incoming signal is higher or lower than the displayed frequency.

Turns on when the transmit frequency of the distant station is higher than your receive frequency.



Turns on when the transmit frequency of the distant station is lower than your receive frequency.

5. **CLOCK**

5-1. **CURRENT TIME AND DATE**

There is a Backup Switch to retain clock memory. If you set the switch ON, turning off the POWER switch, disconnecting the power cable or an intermittent power failure will not erase the clock memories.

5-1-1. **Back-up Switch**

Before setting the clock Backup Switch must be ON.

See page 8
3-1-1. Installing the Microphone and Setting the clock back-up switch
 BACKUP SWITCH

5-1-2. **Setting the Current Time and Date**

1. Press and hold the F key and the TONE key; then turn the Power switch ON to set the clock.
Initial setting is 00:00.00 1.1.1991

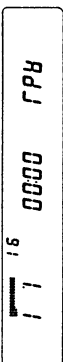

2. **Set the HOUR**

Rotate the Tuning control (0~23) to set the HOUR, then press the TONE key.

3. **Set the MINUTE**

Rotate the Tuning control (0~59) to set the MINUTE, then press the TONE key.

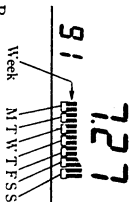

4. **Set the YEAR**
Rotate the Tuning control (00~99) to set the YEAR, then press the TONE key.

5. **Set the MONTH**
Rotate the Tuning control (1~12) to set the MONTH, then press the TONE key.

6. **Set the DAY**
Rotate the Tuning control (1~END) to set the DAY, then press the TONE key.

7. **Set a day of the week (LEVEL METER, see illustration above)**

The segments of the level meter are used to indicate the day of the week.
Rotate the Tuning control to set the day of the week (See accompanying illustration), then press the TONE key. The transceiver will return to previous mode.

4-14. KEY LOCKS

There are three types of lock function.

① Microphone key lock

When the switch on the rear of the microphone is set to the LOCK position, all the microphone keys except the PTT switch are disabled.

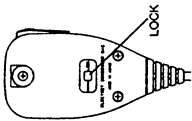

② LOCK

All the panel keys and the Tuning control are disabled. However, the microphone keys work. Press the F key, then press the MHz/LOCK key within 10 seconds. The LOCK indicator lights.

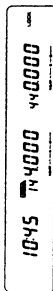

To release the lock, press the F key again, then press the MHz/LOCK key within 10 seconds.

③ ALL LOCK

All operations, except the power switch, volume, and squelch, are disabled.

Switch the power off while the LOCK indicator is on, hold down the MHz/LOCK key, and switch the power on again. The A LOCK indicator lights.



POWER



To release A LOCK, switch the power off while the A LOCK indicator is on, press and hold the MHz/LOCK key, and switch the power on again. The A LOCK operation cannot be canceled by VFO reset or MR reset.

4-3. TRANSMITTER OPERATION

4-3-1. Transmission

CAUTIONS

1. Ensure that an antenna with a low standing wave ratio (less than 1.5 SWR) is attached to the antenna connector before attempting to transmit. Failure to provide proper termination may result in damage to the final amplifier section.

2. High-power and extended transmission increases the unit temperature.

NOTE

1. Always check to ensure the frequency is clear before transmitting.

1. Press the BAND SEL key for the desired transmission band. The PTT indicator will light for the corresponding band. Bands in which the PTT indicator are not lit are used for reception only. (Example: 440 MHz band)

1045 MHz 440000

2. Select the desired operating frequency.
3. Press the PTT switch. The ON AIR indicator will light, and the RF meter will light.

4. Speak into the microphone. The recommended distance to the microphone is 5 cm (2 inches).

NOTE

Talking closer may result in over deviation of your transmit signal, which might be reported as a loss of clarity or an excessively wide transmit signal. Talking too far away may result in reports of weak audio.

5. Release the PTT switch to return to the receive mode. The ON AIR indicator should go out, and the RF meter will return to zero. Simultaneous reception on the other bands is possible during transmit.

NOTE

Some combination of transmit and receive frequencies might cause a reduction in receiver sensitivity.

4-3-2. TX. Alert

Different beeps can be heard for each band by pressing the PTT switch. These signal which band you are transmitting on.

Press the PTT switch while pressing the F key. The TX alert function is then turned on or off.

4-3-3. Time-Out Timer (TOT)

The transceiver has a time-out timer function to prevent possible problems caused by continuous transmission. This function forcibly stops continuous transmission after a certain time. The time-out time is 3, 5, 10, 20, or 30 minutes or OFF (no limit).

1. Press the F key for longer than 1 second.
2. The F indicator will begin to flash. Press the LOW key. The current Time-out time is displayed. (For example 30)

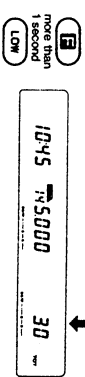

A beep sounds when the time-out timer times out during transmission. The receive state is then re-entered. Press the PTT switch to resume transmission.

4-3-4. Bandwidth Selection

(Requires optional band unit UT-28)
You can select WIDE or NARROW bandwidth only when transmitting in the 28MHz band. Press and hold the F key and the LOW key, then turn the POWER switch ON. This will toggle between WIDE and NARROW. When NARROW is selected "n" will display at the head of the frequency display.

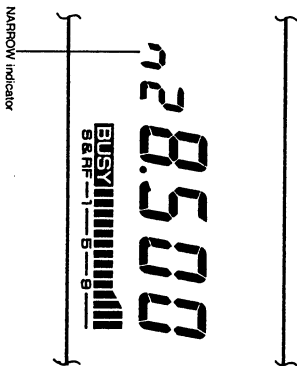

4-12. BEEP TONE LEVEL ADJUSTMENT

- The beep can be set to one of eight levels (off to b7).
1. Press the F key for longer than a second, then press the REV key while the F indicator is flashing. The display will show which beep level is currently in use.
 2. Select the desired value with the tuning control or the UP/DOWN key on the microphone.
 3. If, after 10 seconds, no key has been pressed, the displayed level is set and the previous frequency is redisplayed.

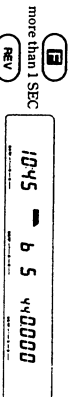

4-13. BEEP TONE FREQUENCIES

The number 0 to 9 on the frequency display are assigned the tones shown below. When the DTSS(*) key is pressed, the tone corresponding to the displayed number is output. The tone is stopped by pressing any key or rotating the Tuning control or VOL control.

0	523.248Hz	5	880.000Hz
1	587.328Hz	6	987.770Hz
2	659.248Hz	7	1046.496Hz
3	698.464Hz	8	1174.656Hz
4	783.984Hz	9	1318.496Hz

- (*) With the optional DTMF unit DTU-2, the DTSS key change to the signaling mode selection key. In this case we recommend to perform the microphone PF key to program the Tone Representation function.
1. Turn the POWER switch OFF.
 2. Press and hold the F key and the DTSS key then turn the POWER switch ON.
 3. Release the F key and the DTSS key.

Alarm Sound Selection

The transceiver provides three different Alarm sound.

1. Press the **CONT SEL** key for the band to select the Alert tone.
2. Turn the Power switch off.
3. Press and hold the **F** key and the **SHIFT** key then turn the Power switch on. The current Alert sound indicator will light.

Alert sound indicator

Low tone **b E L 1**

High tone **b E L 2**

Melody **b E L 3**

4. Rotate the tuning control to select the desired Alert sound.

5. Press any key to return to previous mode.

4-10. AUTOMATIC POWER OFF (APO)

This transceiver also provides an Automatic Power off circuit. The circuit action is described below. (Initial state is off.)

To use the APO function, turn the **SQL** control for the clock band as far as possible to the right.

1. To turn the APO function on/off, press the **F** key for longer than 1 second and then press the **MHz** key.



2. A 5 second audio confirmation alert will sound after 2 hours 59 minutes if no signal has been received and if you have not performed any operation.

1 minute after this alert signal the transceiver will shut itself off.

3. When the APO operates and the transceiver is shut off, the transceiver can be reactivated by turning the **POWER** switch back on.

4-11. DIMMER (DIM)

The intensity of illumination can be set to one of four levels. (D1 thru D4, with D1 being the brightest.)

1. Press the **F** key, then press the **LOW/DIM** key while the **F** indicator lights. The display will show which intensity level is currently in use.

4-4. MEMORY

4-4-1. Microprocessor Memory Back-up

A lithium battery is contained in this transceiver to retain memory. Turning off the **POWER** switch, disconnecting the power cable or an intermittent power failure will not erase the memories. The battery life is estimated at 5 years. When the battery has been exhausted erroneous information might appear in the display.

Lithium battery replacement should be performed by an authorized **KENWOOD** service facility, or your authorized **KENWOOD** dealer. This equipment contains CMOS circuitry and can be damaged by improper replacement procedures.

4-4-2. Microprocessor Initialization

VFO, Call channel and Memory channel 1 frequency	144MHz	220MHz	440/430MHz
Frequency step	5kHz	20kHz	25kHz
Tone frequency	88.5Hz	88.5Hz	88.5Hz

RESET

The transceiver provides Memory reset and VFO reset for each band independently or all bands simultaneously.

NOTES

1. Do not stop resetting halfway.
2. If the display should show erroneous information after initialization you should reset again.

MEMORY RESET

All user programmed data will be initialized.

ALL BAND mode

1. Turn the Power switch off.
2. Press and hold the **MR** key and turn on the **POWER** switch. After 1 second all the LCD indicators will light.
3. Release the **MR** key.

A **PTT** indicator will flash three times.

INDIVIDUAL BAND mode

1. Turn the Power switch off.
2. Press and hold the **F** key and the **BAND SEL** key for the band, then turn on the **POWER** switch. After 1 second all the LCD indicators for the band will light.
3. Release both keys.

The **PTT** indicator for the band will flash three times.

4-4-4. Memory Contents

Each Memory channel is capable of storing the following information:

	Normal channel	Odd Split channel
RX Frequency	<input type="checkbox"/>	<input type="checkbox"/>
TX Frequency(*)	NA	<input type="checkbox"/>
Tone (CTCSS) Frequency (With the optional CTCSS unit TSU-7)	<input type="checkbox"/>	<input type="checkbox"/>
Tone (CTCSS) status	<input type="checkbox"/>	<input type="checkbox"/>
Frequency step	<input type="checkbox"/>	<input type="checkbox"/>
Shift status (*)	<input type="checkbox"/>	NA
REV status (*)	<input type="checkbox"/>	NA
DTSS code, DTSS status	<input type="checkbox"/>	<input type="checkbox"/>
Last operation paging memory number (With the optional unit DTU-2)	<input type="checkbox"/>	<input type="checkbox"/>

○ Can be stored in Memory.

NA: Cannot be stored in Memory.

(*) When a separate TX frequency is entered in a memory, the shift state and reverse on/off programming is removed from the memory.

4-9. TONE ALERT SYSTEM

The Tone Alert function will provide an audible alarm to signal when someone is transmitting on the frequency you are monitoring. Each band can be selected by the T.ALT function independently, and different alarm tones are produced for each band. During the T.ALT function you will not hear voice communication. When used in conjunction with the CTCSS function this would allow the transceiver to act similar to a private pager system!

1. Adjust each SQL control to the threshold point.
2. If you will be using the CTCSS function you should select the proper tone frequency and ensure the CTCSS indicator is on in the display.
3. Press the F key, then the TONE/T.ALT key. T.ALT indicator will light.

NOTES

1. When using CTCSS the incoming signal must be present for approximately 1 second in order for the T.ALT to function properly.
2. If the DTSS function is used in conjunction with the Tone Alert function, Tone Alert is activated only when the same DTSS signal is received.
3. The tone alert function is not activated when CTCSS and DTSS signals are on.

The transceiver will beep for approximately 5 seconds.

The time when the signal is received will be displayed. Up to 99 T.ALT operations are counted on the memory channel display.

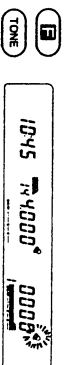

5. The time display is updated by each new incoming signal.
6. During time display the T.ALT function can be released by pressing any front panel key.
7. The T.ALT function can be released by pressing the F key, then the TONE/T.ALT key again.

NOTES

1. You can hear a transmission when the PF key is pressed while the Tone Alert function is activated with the microphone PF key set to the MONITOR switch. (MONITOR page 17)
2. The automatic power off function works after 59 hours and 59 minutes plus one minute when it is used with the tone alert function.

4-4-3. Memory Channels

The microprocessor's VFO memory (without memory channels 1~100, CALL channel, and paging memory channel) will be initialized.

ALL BAND mode

1. Turn the Power switch off.
2. Press and hold the VFO key and turn on the POWER switch.
3. Release the VFO key.

INDIVIDUAL BAND mode

1. Turn the Power switch off.
2. Press and hold the VFO key and the BAND SEL key for the band, then turn on the POWER switch.
3. Release both keys.

4-4-3. Memory Channels

The transceiver has 100 memory channels for each band. The memories are divided into five banks of 20 channels in each. (See Memory Banks Page 32)

BANK 1 :	CH 1 ~ 20
BANK 2 :	CH 21 ~ 40
BANK 3 :	CH 41 ~ 60
BANK 4 :	CH 61 ~ 80
BANK 5 :	CH 81 ~ 100

Stand by with group code.
 If the calling station transmits the group code, the group code and the Paging Mode Memory Channel Number that contains that code will display.
 (Example : For member 2, group code 789 is stored in Paging Mode Memory Channel 2.)

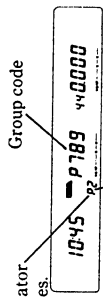

This Paging Mode Memory Channel Number is something other than 0 to indicate a group call has been received.

(* : Err will appear in the display if there is a problem in code identification.)

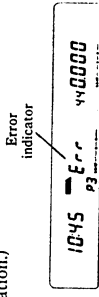

To increase efficiency we recommend cancelling the paging mode after initial calls have been made to prevent transmitting the Paging Code data each time the PTT switch is depressed.

4-8-5. Code Lockout
 Codes are locked out only for receive during the Paging Mode.
 It is possible to temporarily disable Paging Code Memories 1,2,3,4, and 5 during receive. This will allow you to more closely control which individuals, or groups can open your squelch at any given time.
 Paging Code Memories 0 and A cannot be locked out. Locking out a particular code for receive will not prevent the code from being transmitted, should you select that particular Code Memory.

1. Press the DTSS key until the Paging Mode indicator appears in the display.
2. Press the F key for longer than 1 second and then press the DTSS key.
3. Select the Paging Code Memory Channel number you wish to lock out by using the tuning control or the microphone UP/DWN switches.
4. Press the MR/M key.
 A ★ will appear to the left of the Paging Code Memory Channel indicator to remind you that you have locked out this code memory for receive.
5. To restore the code memory for receive use repeat steps 1 thru 4 above.

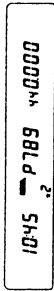

4-4-5. Memory Entry

1. Press the VFO key to select the VFO mode.
2. Select the desired receiver frequency, tone information etc. (For example 443.600MHz)
3. Press the F key momentarily. The F indicator will light on the display, and a memory channel number will appear.

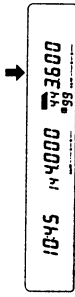

4. Select any memory channel using the Tuning control or microphone UP/DWN keys.
 (For example: CH5)

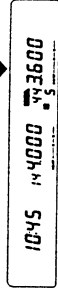

5. **Normal channel**
 Press the MR key within 10 seconds of selecting the memory channel number. The F indicator and memory channel number will turn off. This signals that the data has been properly stored in memory.

5. **Odd Split memory channel** (continue from step 4)
 Press the MR key for longer than 1 second within 10 seconds of selecting the memory channel number. The - + indicator indicates the TX frequency selection mode.

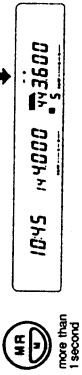

6. **TX frequency entry**
 Select the desired transmit frequency.
 (For example 442.600MHz)

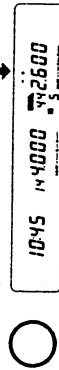

7. Press the MR key.
 8. To confirm the contents of the odd split memory channel:
 Press the MR key. The programmed receiver frequency should appear in the display along with both a "-" and "+", offset direction indicator. This signals you that this channel has an odd split entered.



1045 144000 33600

- To check the transmit frequency press the REV key. The transmit frequency will appear in the display.

- Call Channel
 - Press the VFO key to select the VFO mode.
 - Select the desired Call channel frequency, tone data, etc.
 - Press the F key momentarily. The F indicator will light and the memory channel indicator will light.
 - Press the CALL key within 10 seconds of pressing the F key to enter the data into memory. A long beep will sound and the F indicator and memory channel indicators will turn off to confirm data entry.

4-4-6. Memory Channel Recall

- Press the MR key to select the memory mode. The last memory channel will light on the display.
- Rotate the Tuning control or press the microphone UP/DWN keys to select the desired memory channel.

4-4-7. Memory Banks

● Memory Bank link
Adjacent banks may be linked and used as one large bank. All banks can be linked.

Example
Banks 1 + 2 Channels (1 to 20) + (21 to 40)
Bank 3 Channels 41 to 60
Banks 4 + 5 Channels (61 to 80) + (81 to 100)

- Press the F key. The F indicator will light.
- Display the highest channel number (20, 40, 60, or 80) of the desired bank using the tuning control or microphone UP/DWN keys.

BANK 1
... 18, 19, 20

BANK 2
21, 22, 23, ...



1045 144000 33600

30, 40, 60 or 80

For example, the following groups communicate with each other.

Predetermined frequency	144.660MHz
Group code	789
Member 1	Individual code 111
Member 2	Individual code 222
Member 3	Individual code 333
Member 4	Individual code 444

Member 1	A 111	Member 2	A 222	Member 4	A 444
0	0	2	789	4	789
1	0	0	0	0	0
2	789	Member 3	A 333		
3	444	3	789		
4	★	0			
5					

NOTES

- This function is not available in some areas.
- The PAGING code may not be accepted if the repeater is "identifying". If this should occur you should press the PTT switch again, and retransmit the PAGING code.
- If the distant (receiving) station has activated a battery saver circuit it might not receive the PAGING code. There are two recommended methods of compensating for this situation.
 - Press the PTT switch for a few seconds, send the PAGING code, release the PTT switch, then press the PTT switch again and resend the appropriate code.
 - Proper PAGING operation will occur if you ensure the battery saver circuit is disabled whenever you intend to operate using either the PAGING modes.

4-8-4. Paging Code Monitoring

- Select the desired operating frequency.
- Press the DTSS key until the Paging Mode indicator appears in the display.



1045 144650 440000

P indicates paging mode.

- When the proper code is received, your squelch will open and you will hear an alert tone sequence coming from the speaker. The display will indicate the individual or group code of the calling station.

Stand by with individual code

If the calling station transmits your individual call the display will show Paging Mode Memory Channel 0, and will display the ID code of the calling station.
(Example: Frequency: 144.660 MHz, calling station ID code is 444.)

1045 144650 440000

Zero is displayed to indicate your station is being called.

Memory Consolidation

It is possible to rearrange the memory channels on the transceiver to optimize memory scan operations. This is an advantage especially if there are a large number of open channels separating those channels that actually contain data. Memory Consolidation causes the active memory channels to be rewritten sequentially from the lowest channel without any blank channels in between. The accompanying diagram illustrates this function.

For Example

Data is currently stored in memory channels 1, 5, 8, 12, 15, 19 and 20.

BEFORE CONSOLIDATION

BANK 1
1,.....5,.....8,.....12,.....15,.....19, 20

AFTER CONSOLIDATION

BANK 1
1, 2, 3, 4, 5, 6, 7,.....

1. Press the BAND SEL or CONT SEL key for the band you wish to consolidate.
2. Press the MR key to enter the Memory Channel Mode.
3. Select any memory channel within the bank you wish to consolidate.

4. Press and hold the F key and then press the LOW key.

A beep will sound to signal that consolidation has taken place. The display will change to show the total number of active memory channels after consolidation.

Example
15 channels are memorized in bank 3.



5. To check consolidation on the other banks you can rotate the tuning control, or step thru the memory banks with the microphone UP/DWN switches. The S-meter will show a relative indication of the memory channel usage for the bank, as shown in the accompanying diagram.

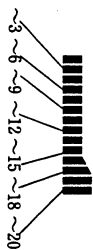

4-8-1. Paging Code Memories

Seven different paging code memories have been provided.

Paging Code Memory No.	Usage
A	Stores your own station code.
0	Automatically stores the calling station's code during receive. Can be used to temporarily store the code for the station to be called.
1~5	Stores group codes, and the codes of other stations.

4-8-2. Code Selection

First, program your Individual Code into Memory A for each band.

1. Press the DTSS key until the Paging indicator lights in the display. See the example below.

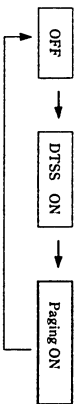

2. Press the F key for longer than 1 second. A beep will sound and the F indicator will begin flashing. While the F indicator is flashing press the DTSS key.
3. The display will change to the Paging Code Memory Channel Selection mode and the Paging Code Memory Channel indicator will begin flashing. Rotate the tuning control or press the microphone UP/DWN switches to select the desired Paging Code Memory Channel.
4. Press the DTSS key to complete the Paging Code Memory Channel Selection and enter the Paging Code Selection mode. The first digit to the right of the large "P" will begin flashing.
5. Rotate the tuning control, press the microphone UP/DWN switches, or press the appropriate key on the microphone keypad to select the first digit of the paging code.
6. Press the DTSS key to enter this digit into memory. The middle digit will then begin flashing.
7. Repeat steps 5 and 6 to complete the programming of this particular paging code. After you enter the final digit of the code the display will return the Paging Code Selection mode.
8. Select the next Paging Code Memory you wish to program as described in 3-7 above.
9. After you have completed programming the Paging Code Memory you can return to the normal frequency display by waiting 10 seconds, or by pressing any front panel key except the DTSS key.

4-8 PAGING (Requires optional DTU-2)

The function is useful for net operations or for selectively calling an individual calling.

Example: When member 2 is called

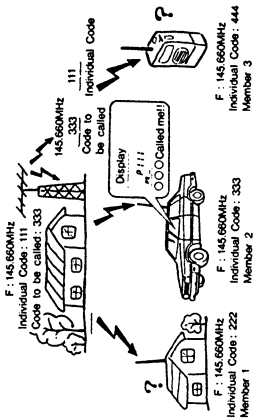

Normal operating procedure would require that you make prior arrangements with all members of the group/net, so that all interested parties know which DTMF code will be used for individual/group calls, and that everyone knows who uses which individual code. Since the paging system makes use of a 3 digit code (000 thru 999) you could have a very large group and still have extra code groups available.

The paging function permits the 3 digit code of the calling station to be displayed in the display to allow easy identification of the calling station.

Simplified operation procedure

Set your individual DTMF code.

Select the desired operating frequency.

Enter the paging mode.

To call other stations

- 1). Select the DTMF code for the distant station.
- 2). Transmit
- 3). Make the QSO.

To listen for a call, wait for the squelch to open.

6. To return to the normal frequency display you can wait 10 seconds or press any front panel key.

4-4-8. Clearing Memory

- Clearing a memory channel
 1. Select the channel that you wish to clear.
 2. Simultaneously press the F key and the MR key.
 3. The memory channel will be cleared and the display will indicate the next active memory channel.
- Clearing an entire memory bank
 1. Select any channel in the bank that you wish to clear.
 2. Simultaneously press the F key and the BAND SEL key.
 3. All channels in the selected bank will be cleared. The next active memory channel will be displayed.

NOTES

1. Memory channel 1 cannot be cleared by either the two methods described above.
2. Only the currently displayed bank is cleared during bank link.

4-4-9. Memory Shift

Using this function you can copy the contents of a memory channel or call channel to the VFO without changing the data in memory. This will allow you to begin tuning at the point specified by the memory channel data.

1. Select the desired Memory Channel.
(For example Ch. 5)
2. Press the F key.

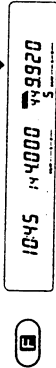

3. Within 10 seconds of pressing the F key press the VFO key to copy the data.

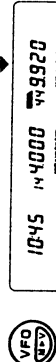

4-5. SCAN

Each band can be scanned independently. For proper scan operation the squelch must be adjusted to the threshold point. Scan can not be used in conjunction with the Tone Alert function.

4-5-1. Scan Options

The following scan options are available:

Band Scan
Scan proceeds over the entire band. This function operates in the VFO mode only.

Programmable Band Scan

The scan range in this mode is specified in memory.

MHz Scan

Scans over a 1 MHz range.

Memory Scan

Scan proceeds through those memory channels in a band or bank that have data stored and have not been locked out. This function operates in the memory mode only.

CALL / VFO Scan

Alternate scanning of the call channel and the VFO.

CALL / Memory Scan

Alternate scanning of the call channel and the memory channel that was last used.

V/M/C (VFO/Memory/Call) Scan

Scans the VFO, the memory channel last used, and the call channel.

Auto Memory Scan

Scans the band scan range. A station that receives a signal for longer than a second at the time is memorized in an empty channel in bank 5.

4-5-2. Hold / Resume Programming

Two types of scan hold/ resume have been provided in this transmitter. The scan hold/ resume can be set for each band.

Time Operated Scan (TO)

In this mode the radio stops on a busy channel, remains there approximately 3 seconds, and then continues to scan even if the signal is still present.

Carrier Operated Scan (CO)

In this mode the radio will stop scanning on a busy channel and remain there until the signal drops out. The radio allows a 2 second delay before it resumes scanning so that you don't lose the station when operators change.

NOTES

1. If a key other than the DTSS key is pressed during operation, code selection mode is canceled.
2. If no action is taken for longer than 10 seconds, code selection mode is automatically canceled.

4-7-3. Using the DTSS function

1. Adjust the SQL control to the threshold point.
2. Press the DTSS key 1 or 2 times until the DTSS indicator appears in the display.
3. The squelch will now remain closed until the correct code group is received.
4. When the PTT switch is pressed on the microphone the selected code group will be transmitted. It will take about 1/2 second to transmit the 3 tones. The microphone will be muted while the tones are being transmitted.
5. To cancel DTSS operation press the DTSS key until the DTSS indicator turns off.

4-7-4. Using DTSS with a Repeater

The DTSS signal is not transmitted immediately after you press the PTT switch. A programmable delay time has been incorporated to allow the DTSS signal to be passed by repeaters with slow response times. You can select a delay time of 250 ms, 450 ms, 750 ms, 850 ms, or 1 second.

When operating simplex mode the 250ms will automatically be selected for you. No other choice is available in this mode, even though you may have selected a different delay. In modes other than simplex you may select between the remaining delay periods (450 ms, 750 ms, 850 ms, or 1 second).

NOTE

250ms cannot be selected for offset modes.

To select desired delay time:

1. Press and hold the F key, then press the DTSS key. The display will indicate the current delay (250ms is not displayed).

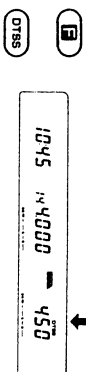

2. Rotate the tuning control or press the microphone UP/DWN switches to select the desired delay time.
3. To return to the normal frequency display wait 10 seconds for automatic return, or press any key.

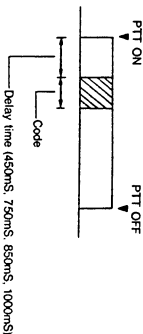

4-7. DTSS (Dual Tone Squelch System) (Requires optional DTU-2)

This function allows the squelch to be turned on in the receive mode on reception of a three-digit code matching the DTSS code selected in your radio.

Once the squelch is turned on by reception of a matching code, it operates normally from then on. If no signal is received for longer than 2 seconds, the squelch is turned off until a matching code is received.

NOTES

1. This function is not available in some areas.
2. The DTSS code may not be accepted if the repeater is "identifying". If this should occur you should press the PTT switch again, and retransmit the DTSS code.
3. If the distant (receiving) station has activated a battery saver circuit, it might not receive the DTSS code. There are two recommended methods of compensating for this situation.
 1. Press the PTT switch for a few seconds, send the DTSS code, and resend the appropriate code.
 2. Proper DTSS operation will occur if you ensure the battery saver circuit is disabled whenever you intend to operate using either the DTSS modes.

4-7-1. DTSS Code

DTSS codes from 000 through 999 can be selected from the VFO mode and stored in memory channels and CALL channel.

The initial setting of the DTSS Code is 000.

4-7-2. DTSS Code Selection

1. Press the DTSS key 1 or 2 times until DTSS appears in the display.

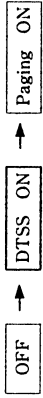

2. Press the F key for longer than 1 second and then press the DTSS key. The display will change to the DTSS code entry mode. (See example below.) The digit just to the right of the "C" will be flashing.



3. Select any digit from 0-9 by rotating the Tuning control, or by pressing the UP/DWN switches on the microphone, then press the DTSS key. (Or press the desired digit on the microphone keypad)
4. After you select the first digit a beep will sound and the middle digit will begin flashing. Select the desired digit by using any of the methods described above.
5. Select the final digit as described above. After the last digit has been entered the display will return to the normal frequency mode, indicating the tone selection process has been successfully completed.

NOTE

With both the CTCSS and the DTSS are turned on scanning will stop when the proper CTCSS tone is received. Squelch will open only if the DTSS signal matches when scan stops.

The radio is delivered from the factory in the Time Operated Scan mode. To switch between the modes use the following procedure.

● Hold/Resume selection

1. Press the F key for longer than 1 second. The F indicator will flash.
2. While the indicator is flashing press the VFO key. This will toggle the Hold / Resume mode to the Carrier Operated mode and the CO indicator will light.
3. To return to Time Operated mode repeat steps 1 and 2.

4-5-3. Band Scan

1. Adjust the SQL control of the band to the threshold point.
2. Hold down the CONT SEL key for longer than a second (for the VFO mode). (The operating band changes at the same time.)
3. The MHz indicator and CONT SEL indicators will begin blinking, and scan will begin.

4. Scan will begin in an upwards direction. You can reverse the direction of scan by turning the Tuning control or pressing the microphone UP/DWN keys. The tuning step size depends upon the current Frequency Step selection.
5. Scan will stop on a busy channel, i.e. a station that is strong enough to open the squelch and turn on the BUSY indicator.
6. Press the microphone PTT switch or any other key (except CONT SEL and BAND SEL). The operating band scan will then stop.

Turns the operation band scan on or off. (Blinks during scanning)

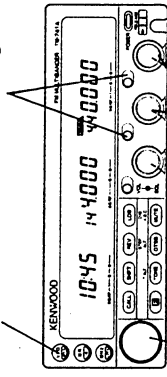

Reverse the direction of scan. Stop scan during scanning.

7. You scan all two bands at the same time by repeating step 1 to 6 for the other band. Scan will stop only on the band(s) that receive a signal. The other band(s) will continue to scan.

4-5-4. Programmable Band Scan

The lower- and upper-limit frequencies of a program scan are set in advance for each band.

- Lower and the Upper Scan Limits Entry
Display the lower frequency limit, press and hold the F key, then press the VFO key. Display the upper frequency limit, press and hold the F key, then press the MHz key.

- Operation
 1. Adjust the SQL control to the threshold point.
 2. Select a frequency between the two programmed scan limits.
 3. Press the VFO key for longer than 1 second. The MHz indicator will begin flashing as a visual reminder the transceiver is scanning.

NOTE

When the current frequency step is different from the upper or lower limit frequency step, the frequencies are scanned from the lower limit and the step depends on that of the lower frequency limit.

Continue to 4-5-3 step 4.

- #### 4-5-5. MHz Scan
1. Adjust the SQL control to the threshold point.

2. Press the MHz key during band scan or programmable band scan. The MHz indicator will begin flashing as a visual reminder the transceiver is MHz scanning.

3. Scanning will start in an upwards direction over a 1 MHz range.
Continue to 4-5-3 step 3

4-5-6. Memory Channel Scan

- NOTE
 1. Only those memory channels that have data entered, and that have not been locked out, it will be scanned.
 2. Scan does not start unless there are 2 channels that have data entered.

The memory in a band and bank can be scanned.

1. Adjust the SQL control to the threshold point.
2. ● Memory scan in band
Press the CONT SEL key or the BAND SEL key of the band to change the operating band. Press the MR key for longer than 1 second to initiate memory scan of the band.

- Memory scan in bank
When the band is in the memory channel mode press the CONT SEL key for longer than 1 second to initiate memory bank scan. (The operation band changes at the same time.)

Continue to 4-5-3 step 4.

4-6-4. Autopatch Operations (U.S.A. version only)

Some repeaters offer a service known as autopatch. This feature allows you to dial a telephone number from your transceiver and carry out a telephone conversation much like a car telephone, or cellular telephone. This function requires the use of a DTMF (Dual Tone Multi Frequency) pad. The MC-45DM optional microphone provides the normal keys you would have on your telephone at home, in addition to the normal 12 keys that are found on your telephone as well as 4 additional keys, A, B, C and D. These keys are required by some repeater systems for various control operator of your repeater to determine if their use is required. A chart is provided that lists the various tone frequencies that are generated by the keypad. (Fig. 1)

- To activate the keypad:
1. Press and hold the PTT switch.
 2. Press the keys just like you would dial your telephone at home.
 3. The transceiver will remain keyed for approximately 2 seconds after you press each number, so you can release the PTT switch without unkeying the transceiver.

NOTE
Some repeaters will require the use of a special key sequence to activate the autopatch function. You should check with your control operator for this sequence.

(Hz)	1209	1336	1477	1633
697	1	2	3	A
770	4	5	6	B
852	7	8	9	C
941	*	0	#	D

4-6-3. **Tone and CTCSS Operation**
Some repeaters require the use of a control signal to activate the repeater. Several different methods are currently in use. In the United States sub-audible tones are sometimes used, 38 different sub-audible frequencies being possible.
The CTCSS function has been activated the radio will not open squelch until the proper tone is received.

IN EUROPE AND UNITED KINGDOM a 1750 Hz tone is used in transmit. Press and hold the microphone 1750 key to transmit with the access tone, you need not press the PTT switch.

Since this tone is required in Europe and the United Kingdom a 1750 Hz tone encoder is included with models delivered to these countries.

● **Tone Frequency Selection**

Each band can be selected the Tone Frequency independently.

1. Press the F key for longer than 1 second. The F indicator will flash. Press the TONE key. The current tone frequency will show in the display.
2. Rotate the Tuning control or press the microphone UP/DWN key to select the desired tone frequency.
3. When the desired tone frequency is selected, the previous mode is resumed 10 seconds after selection or when the any front panel key is pressed.

Tone Frequency (Hz)

67.0	82.5	97.4	114.8	136.5	162.2	192.8	233.6
71.9	85.4	100.0	118.8	141.3	167.9	203.5	241.8
74.4	88.5	103.5	123.0	146.2	173.8	210.7	250.3
77.0	91.5	107.2	127.3	151.4	179.9	218.1	
79.7	94.8	110.9	131.8	156.7	186.2	225.7	

● **Tone/CTCSS Operation**

Press the TONE key and select the desired Tone mode. When the T indicator appears in the display the transmitter will transmit the desired tone. T one signals can be transmitted.

When the CTCSS indicator appears in the display the transmitter will transmit the desired tone and will also not open until the proper tone is received as a portion of the incoming receive signal.

When no indicator is on, the radio will not make use of either tone feature. Set TONE to OFF for transmission with a repeater or transmission without tone squelch (CTCSS).

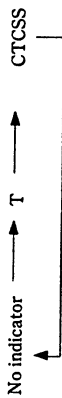

4-5-7. **CALL Scan**

CALL / VFO Scan

Press the CALL key for longer than 1 second in the VFO mode to start alternate scanning of the VFO frequency shown on the display and the call channel.

CALL / Memory Channel Scan

Press the CALL key for longer than 1 second in the memory channel mode to start alternate scanning of the call channel and the memory channel that was last used.

4-5-8. **V/M/C (VFO/Memory/Call) Scan**

In the CALL channel mode press the CONT SEL key for longer than 1 second to scan the VFO frequency shown on the display, the memory channel that was last used and the call channel in turn.

4-5-9. **Automatic Memory Scan**

This function will cause the transmitter to begin a search for active channels. When it acquires a signal that lasts for at least one second it will sequentially write the data into open memory bank number 5 channels as illustrated in the accompanying diagram.

1. Press and hold the F key.
2. Then press the CONT SEL key for the band you want to scan. A beep will sound and the radio will begin scanning.

3. Release both keys.
The transceiver will beep each time it enters a frequency into memory. Scanning will stop once it has entered a frequency into all of the open (bank 5) memory channel positions.

Bank 5 memory status before auto memory scan

81		
82		
83	438.800	DTSS
84	438.900	
85		
*		
*		
98	439.000	CTCSS

Programmable Band scan

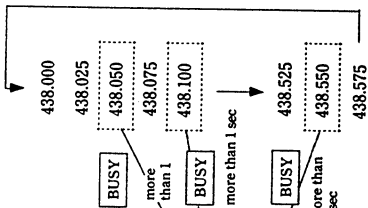

Bank 5 memory status during auto memory scan

81	438.050	
82	438.100	
83	438.800	DTSS
84	438.900	
85	438.550	
*		
*		
98	439.000	CTCSS

4-5-10. Memory Channel Lockout

This function allows you to specify which memory channels you wish to skip during memory channel scan.

1. Press the **MIR** key to select the memory channel mode.
2. Select the memory channel that you wish to skip by turning the Tuning control or pressing the microphone UP/DOWN keys.
3. Press the **F** key for longer than 1 second. The **F** indicator will begin to flash. Within 10 seconds of pressing the **F** key press the **MIR** key. A **★** indicator will appear to the left of the memory channel number. This indicates the memory channel will be skipped during the memory channel scan mode.

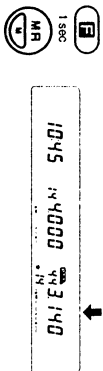

1. Repeat steps 2 and 3 to lock out any other channels you wish to skip.
2. To cancel the lockout, select the desired memory channel as described in steps 1, 2 and 3 above. A **★** indicator should appear to the left of the memory channel number. Press the **F** key for longer than 1 second and then press the **MIR** key. The **★** indicator should turn off.

Demonstration mode

The microprocessor has been programmed to provide a short demonstration of the capabilities of the transceiver. To activate this demonstration press and hold the **CALL** key while you turn on the power switch. After a 10 seconds delay the transceiver will enter the demonstration mode.

You can cancel this function by holding the **VFO** key down while you turn on the power.



NOTE
 When you cancel the demonstration mode you will clear all VFO information, and reset the VFO's to the factory defaults. You won't erase your memory channel data, just the VFO data, so you might wish to store your VFO data into memory before entering the demonstration mode so this information can be easily recalled.

4-6. REPEATER OPERATION

4-6-1. Transmitter Offset

All amateur radio repeaters use a separate receive and transmit frequency. The receive frequency may be above or below the transmit frequency. The configuration of most repeaters fall into one of the categories listed below:

144 MHz band	220 MHz band	TM-71A band 440/430 MHz	TM-71E band 430 MHz
+600 kHz	+1.5 MHz	+5 MHz	+1.6 MHz
-600 kHz	-1.5 MHz	-5 MHz	-1.6 MHz
-	-	-	-7.6 MHz

● Offset Direction

To select the desired transmitter offset direction press the **SHIFT** key. Each time you press the key the transceiver advances from one direction to the other, i.e. "-" to "+" or "-" to "-" with European versions or 1200 MHz band) to no offset (simplex).

● Automatic Offset (U.S.A. and Canada versions)
 The TM-641A/741A has been programmed according to the standard ARRL (Amateur Radio Relay League) Band Plan with regard to transmitter offset direction. See the accompanying chart for additional information about this programming. You can, of course, override this by using the **SHIFT** key if desired.

145.1	145.3	146.0	146.4	146.6	147.0	147.4	147.6	148.0
S	-	S	+	S	-	+	S	-
220.000		223.920	224.995					
S		S		-		S		

S: simplex

4-6-2. Reverse Function

Some repeaters use a "Reverse Pair", i.e. the transmit receive frequencies are the reverse of other repeaters. For example, repeater A uses 146,000 for a transmit frequency (INPUT) and 148,600 for a receive frequency (OUTPUT). Repeater B might use 148,600 for a transmit frequency and 146,000 for a receive frequency. It would be inconvenient to have to reprogram the transceiver each time you wanted to use these repeaters. The **REV** key allows you to easily reverse the transmit and receive frequencies. To use the **REV** function press the **REV** key. The **REV** indicator goes on on the display to indicate that you are working a reverse pair. To return to normal press the **REV** key again. The **REV** indicator goes off. This function is also useful to check the input frequency of the repeater so that you can determine if you are within range for simplex communications.