

P25 Radio Systems



Training Guide

DE DANIELS™
ELECTRONICS LTD.

www.danelec.com



P25 Radio Systems

Training Guide

NOTE

Copyright © 2007 Daniels Electronics Ltd. All rights reserved. No part of this publication may be reproduced, stored in a retrieval system or transmitted in any form or by any means, electronic, mechanical, photocopying, recording or otherwise, without the prior written consent of Daniels Electronics Ltd.

The stylized "Daniels Electronics Ltd." and "DE" logo are registered Canadian and US trademarks of Daniels Electronics Ltd.

The stylized "Daniels Electronics Ltd." and "DE" logo are trademarks of Daniels Electronics Ltd.

IMBE™ and AMBE+2™ are trademarks of Digital Voice Systems, Inc.

EDACS® is a registered trademark of M/A-COM, Inc.

Aegis™ is a trademark of M/A-COM, Inc.

iDEN™ is a trademark of Motorola, Inc.

GSM™ is a trademark of GSM Association.

ANSI® is a registered trademark of the American National Standards Institute

DOCUMENT REVISION
DEFINITION

Daniels Electronics Ltd. utilizes a three-level revision system. This system enables Daniels to identify the significance of a revision. Each element of the revision number signifies the scope of change as described in the diagram below.

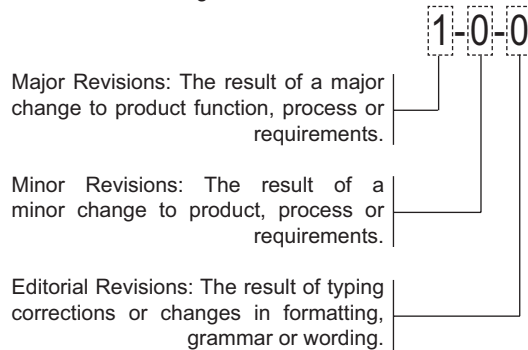

Three-level revision numbers start at 1-0-0 for the first release. The appropriate element of the revision number is incremented by 1 for each subsequent revision, causing any digits to the right to be reset to 0.

For example:

If the current revision = 2-1-1 Then the next major revision = 3-0-0

If the current revision = 4-3-1 Then the next minor revision = 4-4-0

If the current revision = 3-2-2 Then the next editorial revision = 3-2-3

Daniels Electronics Ltd.
43 Erie Street, Victoria, BC
Canada V8V 1P8
www.danelec.com
sales@danelec.com

Toll Free Canada and USA:
phone: 1-800-664-4066
fax: 1-877-750-0004

International:
phone: 250-382-8268
fax: 250-382-6139

PRINTED IN CANADA

Document Number: TG-001
Revision: 2-0-0
Revision Date: January 2007

For the past 50 years Daniels has provided customers in North America and internationally with highly reliable Base Stations and Repeaters that are environmentally robust to operate in rugged and extreme temperature conditions where low current consumption (solar powered) is a key requirement.

ABOUT DANIELS
ELECTRONICS LTD.

Daniels has been a pioneering member of the P25 Digital standard, for radio system interoperability between emergency response governmental organizations, providing enhanced functionality and encryption. Our products operate between 29 - 869 MHz and are available in a variety of Base Station and Repeater configurations for two way voice and mobile data applications.

Our self-servicing customers range from Forestry and National Park services through Police and Fire departments and on to Utility and Transportation groups. Our products have been deployed in every imaginable situation from the Antarctic to Hawaiian mountaintops to Alaska, enabling respondents to Forest Fires, Ground Zero rescue and routine patrols.

Daniels is an industry leader in Analog and P25 radio systems design. We offer modular rack mounted Base Stations and Repeaters capable of operating in the following bands:

Low Band VHF
VHF AM
VHF FM
UHF FM
800 MHz

Pete Lunness is a member of the Applied Science Technologists & Technicians of British Columbia and has a Diploma in Electronics Engineering Technology from Camosun College in Victoria, B.C.

ABOUT THE AUTHOR

Pete has worked as a radio technician for the B.C. Ministry of Forests, helping to tune, maintain and install some of the more than 350 Daniels Electronics repeater systems owned by the Forest Service throughout British Columbia. He has been at Daniels for eight years, working in the Engineering (Design and Development) department, the Sales department and most recently in the Technical Services department. For the past five years, Pete has been the instructor for Daniels technical training courses on the MT-3 analog and MT-4 P25 digital radio systems.

Many employees throughout Daniels Electronics helped write, compile, research and check the information contained in this document including Ali Mehrpouyan, Steve Burfoot, Peter Chan and Dale Reitsma.

REFERENCES Many references were used in the creation of this document. Following is a list of references for P25 information:

Aeroflex, Inc.

Aeroflex Incorporated is a multi-faceted high-technology company that designs, develops, manufactures and markets a diverse range of microelectronic and test and measurement products. Aeroflex is the manufacturer of the IFR 2975 P25 Radio Test Set.

www.P25.com

www.aeroflex.com

APCO International

The Association of Public-Safety Communications Officials - International, Inc. is the world's oldest and largest not-for-profit professional organization dedicated to the enhancement of public safety communications

www.apcointl.org

DVSI

Digital Voice Systems, Inc., using its proprietary voice compression technology, specializes in low-data-rate, high-quality speech compression products for wireless communications, digital storage, and other applications. DVSI is the manufacturer of the IMBE™ and AMBE+2™ vocoders.

www.dvsinc.com

PTIG

The Project 25 Technology Interest Group (PTIG) is a group composed of public safety professionals and equipment manufacturers with a direct stake in the further development of, and education on, the P25 standards. PTIG's purpose is to further the design, manufacture, evolution, and effective use of technologies stemming from the P25 standardization process.

www.project25.org

TIA

The Telecommunications Industry Association is the leading U.S. non-profit trade association serving the communications and information technology industry, with proven strengths in market development, trade shows, domestic and international advocacy, standards development and enabling e-business.

www.tiaonline.org

Contents

Chapter 1: Introduction To P25	1
What is Project 25?	1
P25 Phases	2
Conventional vs. Trunked	3
How does P25 work?	3
P25 Radio System Architecture	5
Benefits of P25	8
Other Digital Standards	12
Chapter 2: P25 Interface Standards	15
P25 Standards – General System Model	15
RF Sub-System	17
Common Air Interface	17
Inter Sub-System Interface	18
Telephone Interconnect Interface	19
Network Management Interface	19
Data Host or Network Interface	19
Data Peripheral Interface	20
Fixed Station Interface	20
Console Sub-System Interface	21
Chapter 3: P25 Practical Applications	23
Analog to P25 Transition	23
P25 Frequency Bands	23
Hexadecimal and Binary Numbering	23
P25 Digital Code Definitions	24
P25 Voice Message Options	32
P25 Data Applications	34
Conventional Control Messages	34
P25 Encryption	36
Analog vs. P25 Digital Coverage	37
P25 Radio System Performance Testing	40
P25 vs. Analog Delay Times	42
Chapter 4: Anatomy of the Common Air Interface	45
Voice	45
Data	46
Frame Synchronization and Network Identifier	46
Status Symbols	47
Header Data Unit	47
Voice Code Words	48
Logical Link Data Unit 1	49
Logical Link Data Unit 2	50
Low Speed Data	51
Terminator Data Unit	51
Packet Data Unit	53
Data Header and Data Block Formats	54
Other Data Formats	57

Chapter 5: Conventional Fixed Station Interface	59
Introduction	59
Analog Fixed Station Interface	61
Digital Fixed Station Interface	64
Chapter 6: P25 Trunking	67
Introduction to P25 Trunking	67
Implicit / Explicit	68
Registration	69
Addressing	70
Control Channel Messages	72
Inbound Signaling Packet Access via Slotted ALOHA	72
Trunking System Operation	73
Traffic Channel Ownership	74
Encryption	75
Data Packet Structures for Single and Multi Block Messages	75
Chapter 7: IMBE™ And AMBE+2™ Vocoders	81
Chapter 8: P25 Glossary of Terms	83



CHAPTER 1: INTRODUCTION TO P25

This document is written with the intention of supplying the reader with a simple, concise and informative description of Project 25. The document assumes the reader is familiar with conventional Two-Way Radio Communications systems. The naming and numbering conventions used in this document are those used in the TIA documents. Some manufacturers use different naming and numbering conventions. Project 25 is a standards initiative, to be amended, revised, and added to as the users identify issues, and as experience is gained.

WHAT IS PROJECT 25?

Project 25 (P25) is a set of standards produced through the joint efforts of the Association of Public Safety Communications Officials International (APCO), the National Association of State Telecommunications Directors (NASTD), selected Federal Agencies and the National Communications System (NCS), and standardized under the Telecommunications Industry Association (TIA). P25 is an open architecture, user driven suite of system standards that define digital radio communications system architectures capable of serving the needs of Public Safety and Government organizations. The P25 suite of standards involves digital Land Mobile Radio (LMR) services for local, state/provincial and national (federal) public safety organizations and agencies. P25 open system standards define the interfaces, operation and capabilities of any P25 compliant radio system. A P25 radio is any radio that conforms to the P25 standard in the way it functions or operates. P25 compliant radios can communicate in analog mode with legacy radios and in either digital or analog mode with other P25 radios. The P25 standard exists in the public domain, allowing any manufacturer to produce a P25 compatible radio product.

P25 LMR equipment is authorized or licensed in the U.S., Canada and Australia.

in the U.S. under the National Telecommunications and Information Administration (NTIA) or Federal Communications Commission (FCC) rules and regulations.

in Canada under Industry Canada (IC) rules and regulations.

in Australia under the Australian Communications and Media Authority (ACMA) rules and regulations.

Although developed primarily for North American public safety services, P25 technology and products are not limited to public safety alone and have also been selected and deployed in other private system applications, worldwide. The Project 25 users' process is governed by an eleven-member steering committee made up of nine U.S. federal, state and local government representatives and two co-directors. Project 25 has four main objectives:

-
- ensure competition in system life cycle procurements through Open Systems Architecture

 - allow effective, efficient and reliable intra-agency and inter-agency communications

 - provide enhanced functionality and capabilities with a focus on public safety needs

 - improve radio spectrum efficiency

TIA (Telecommunications Industry Association) is a national trade organization of manufacturers and suppliers of telecommunications equipment and services. It has substantial experience in the technical aspects of radio communications and in the formulation of standards with reference thereto. TIA is accredited by the American National Standards Institute (ANSI®) as a Standards Developing Organization.

P25 PHASES

P25 compliant technology is being deployed in several phases.

Phase 1

Phase 1 radio systems operate in 12.5 KHz analog, digital or mixed mode. Phase 1 radios use Continuous 4 level FM (C4FM) non-linear modulation for digital transmissions. Phase 1 P25 compliant systems are backward compatible and interoperable with legacy systems, across system boundaries, and regardless of system infrastructure. In addition, the P25 suite of standards provide an open interface to the RF Sub-System to facilitate interlinking of different vendors' systems.

Phase 2

Phase 2 radio systems will achieve one voice channel or a minimum 4800 bps data channel per 6.25 kHz bandwidth efficiency. The P25 Phase 2 FDMA solution is finalized (CQPSK), and an alternate TDMA solution is currently under development. Phase 2 implementation achieves the goal of improved spectrum utilization. Also being stressed are such features as interoperability with legacy equipment, interfacing between repeaters and other sub-systems, roaming capacity and spectral efficiency/channel reuse.

Phase 3

Implementation of Phase 3 will address the need for high-speed data for public-safety use. Activities will encompass the operation and functionality of a new aeronautical and terrestrial wireless digital wideband/broadband public safety radio standard that can be used to transmit and receive voice, video and high-speed data in wide-area, multiple-agency networks. The European Telecommunications Standards Institute (ETSI) and TIA are working collaboratively on Phase 3, known as Project MESA (Mobility for Emergency and Safety Applications). Current P25 systems and future Project MESA technology will share many compatibility requirements and functionalities.

This document deals almost exclusively with P25 Phase 1. Phase 2 and Phase 3 standards are under development.

CONVENTIONAL VS. TRUNKED

In general, radio systems can be separated into conventional and trunked systems. A conventional system is characterized by relatively simple geographically fixed infrastructure (such as a repeater network) that serves to repeat radio calls from one frequency to another. A trunked system is characterized by a controller in the infrastructure which assigns calls to specific channels. P25 supports both trunked and conventional radio systems. While this document deals primarily with conventional radio systems, more detailed information about P25 trunking can be found in Chapter 6.

HOW DOES P25 WORK?

P25 radios operate in a similar manner to conventional analog FM radios. P25 radios will operate in conventional analog mode, making them backwards compatible with existing analog radio systems. When the P25 radio operates in digital mode, the carrier is moved to four specific frequency offsets that represent four different two-bit combinations. This is a modified 4 level FSK used in analog radio systems. In analog mode, the P25 radio will operate exactly the same as conventional analog systems, with the capability for CTCSS, DCS, pre-emphasis and de-emphasis, wideband or narrowband operation and other standard analog features.

In P25 digital mode, the P25 transmitter will convert all analog audio to packets of digital information by using an IMBE™ vocoder, then de-vocode the digital information back to analog audio in the receiver. Error correction coding is added to the digital voice information as well as other digital information. Analog CTCSS and DCS are replaced by digital NAC codes (as well as TGID, Source and Destination codes for selective calling). Encryption information can be added to protect the voice information, and other digital information can also be transmitted such as a user defined low speed data word or an emergency bit.

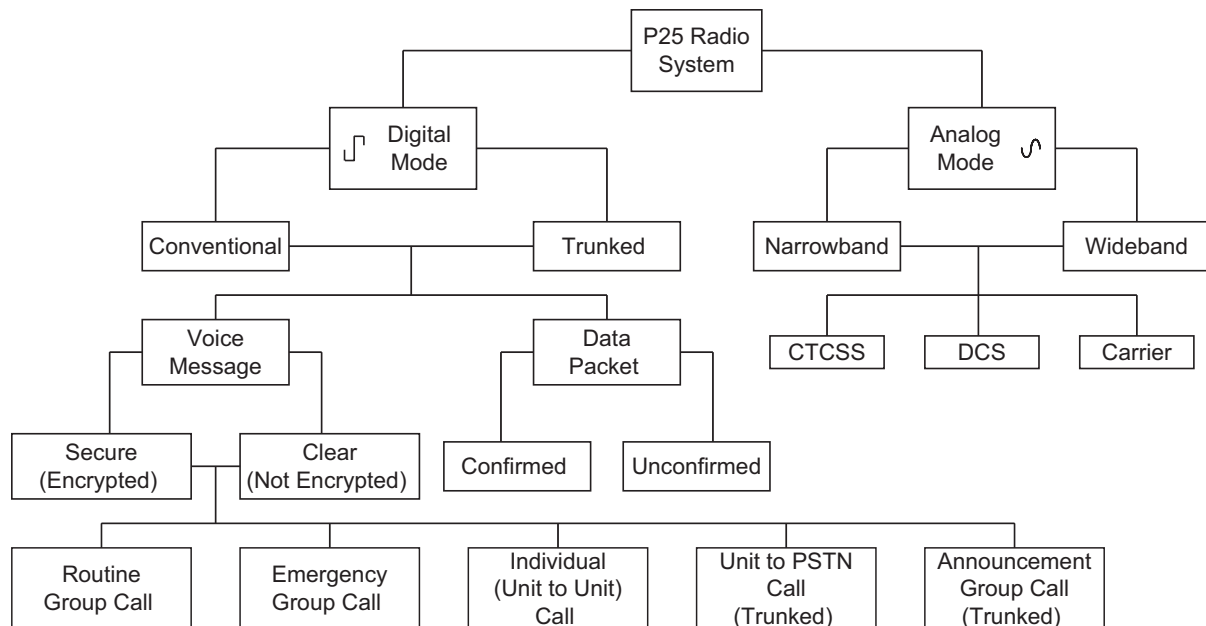

Figure 1-1: P25 Radio System Operation

Figure 1-1 shows the different operational modes of P25 Radio Systems in digital and analog modes.

P25 systems use the Common Air Interface (CAI). This interface standard specifies the type and content of signals transmitted by P25 compliant radios. A P25 radio using the CAI should be able to communicate with any other P25 radio using the CAI, regardless of manufacturer.

P25 Phase 1 radios are designed for 12.5 kHz channel bandwidths. In Phase 2, P25 radios will use 6.25 kHz of bandwidth per voice channel. P25 radios must also be able to operate in analog mode on 25 kHz or 12.5 kHz channels. This backward compatibility allows P25 users to gradually transition to digital while continuing to use analog equipment.

P25 secure transmissions may be enabled by digital encryption. The P25 standards specify the use of the Advanced Encryption Standard (AES) algorithm, Data Encryption Standard (DES-OFB) algorithm, and other encryption algorithms. There are additional standards and specifications for over-the-air rekeying (OTAR) features. OTAR allows subscriber encryption key management through a radio network.

P25 channels that carry voice or data operate at 9600 bits per second (bps). These voice or data channels are protected by forward error correction, which compensates for poor RF conditions and improves useable range. P25 supports data transmission, either piggybacked with voice (low speed data), or in several other modes up to the full traffic channel rate of 9600 bps.

P25 RADIO SYSTEM ARCHITECTURE

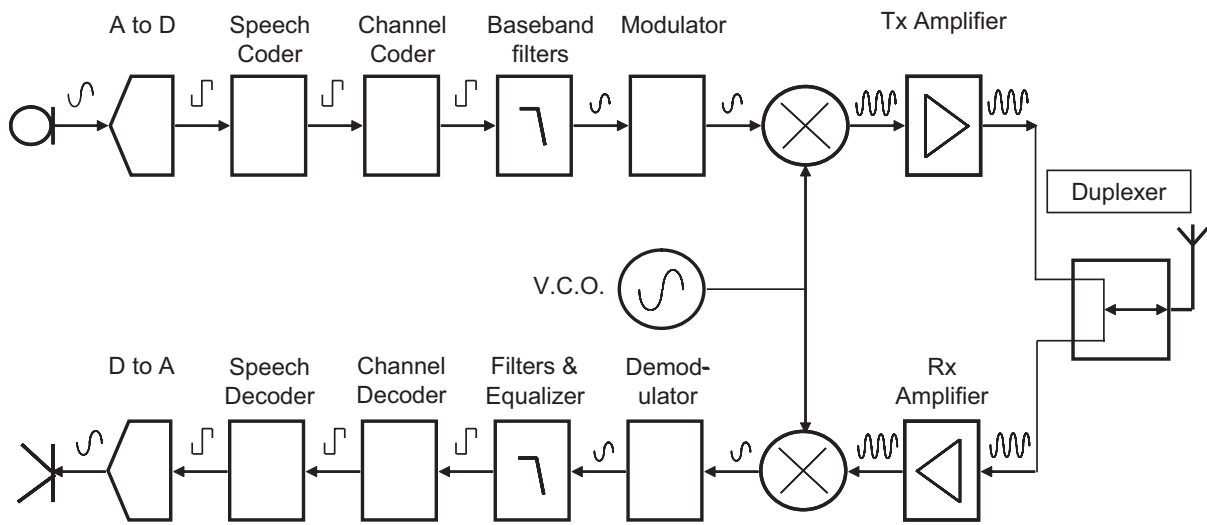

Figure 1-2: P25 Radio System Architecture

Figure 1-2 represents a basic digital transceiver.

The P25 Radio System Architecture can be broken down into three main areas.

A to D / D to A and Speech Coding / Decoding

P25 uses a specific method of digitized voice (speech coding) called Improved Multi-Band Excitation (IMBE™). The IMBE™ voice encoder-decoder (vocoder) listens to a sample of the audio input and only transmits certain characteristics that represent the sound. The receiver uses these basic characteristics to produce a synthetic equivalent of the input sound. IMBE™ is heavily optimized for human speech and doesn't do very well in reproducing other types of sounds, including dual-tone multifrequency (DTMF) tones and continuous test tones.

The IMBE™ vocoder samples the microphone input producing 88 bits of encoded speech every 20 milliseconds. Therefore, the vocoder produces speech characteristics at a rate of 4400 bits per second.

Channel Coding / Decoding

Channel Coding is the method in which digital RF systems utilize error correction and data protection techniques to ensure that the data (voice or control) arrives and is recovered correctly. The error correction and data protection are designed to improve the system performance by overcoming channel impairments such as noise, fading and interference.

P25 channel codes include; interleaving and linear block codes such as Hamming codes, Golay codes, Reed-Solomon codes, Primitive BCH, and shortened cyclic codes.

Modulating / Demodulating and Filtering

In Phase 1, a 12.5 KHz channel is used to transmit C4FM modulated digital information. C4FM modulation is a type of differential Quadrature Phase Shift Keying (QPSK) where each symbol is shifted in phase by 45 degrees from the previous symbol. Although the phase (frequency) is modulated for C4FM, the amplitude of the carrier is constant, generating a constant envelope frequency modulated waveform.

In Phase 2 (FDMA solution), digital information is transmitted over a 6.25 KHz channel using the CQPSK modulation format. CQPSK modulates the phase and simultaneously modulates the carrier amplitude to minimize the width of the emitted spectrum which generates an amplitude modulated waveform.

The modulation sends 4800 symbols/sec with each symbol conveying 2 bits of information. The mapping between symbols and bits is shown below:

Information Bits	Symbol	C4FM Deviation (Phase 1)	CQPSK Phase Change (Phase 2)
01	+3	+1.8kHz	+135 degrees
00	+1	+0.6kHz	+45 degrees
10	-1	-0.6kHz	-45 degrees
11	-3	-1.8kHz	-135 degrees

The C4FM modulator is comprised of a Nyquist Raised Cosine Filter, a shaping filter, and an FM modulator. The CQPSK (Phase 2 FDMA solution) modulator is comprised of In Phase (I) and Quadrature Phase (Q) amplitude modulators that modulates two carriers. The Q phase is delayed from the I phase by 90 degrees. The filtered output of a 5-level signal, derived from lookup table information, is used to drive the I and Q modulators.

C4FM Modulator



CQPSK Modulator

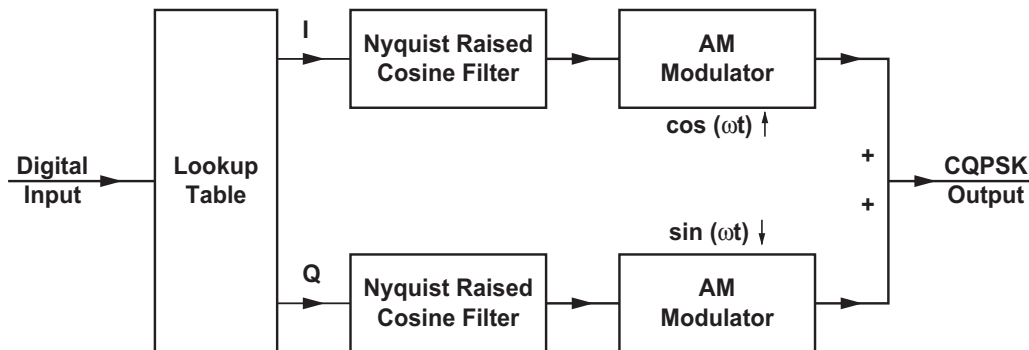

Figure 1-3: C4FM and CQPSK Modulators

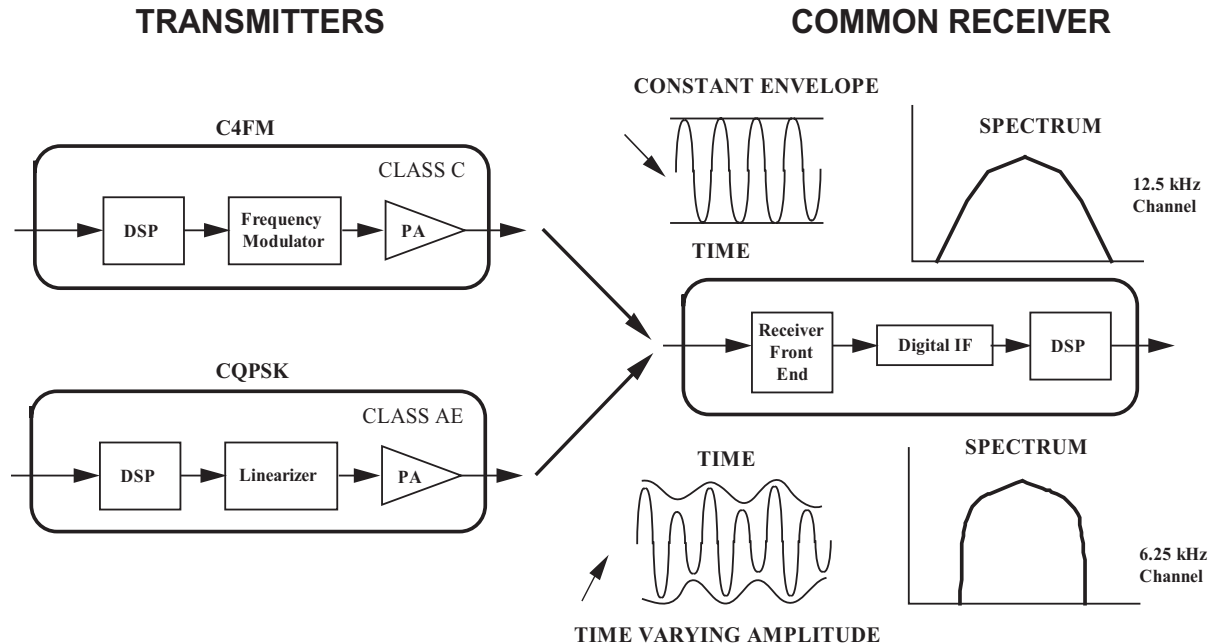

Figure 1-4: QPSK Demodulator (Common Receiver)

The QPSK demodulator receives a signal from either the C4FM modulator or the CQPSK modulator. The frequency modulation detector in the first stage of the demodulator allows a single, Phase 1 demodulator to receive analog FM, C4FM, and CQPSK. The benefit of this is that when migrating to a Phase 2, 6.25 kHz FDMA system, only the transmitter needs to change. The multiple use of the demodulator also means that a Phase 1 receiver can receive analog or digital signals equally well. Phase 2 FDMA requires transmitter linearization to pass the amplitude component of the CQPSK signal. Linear amplifiers and battery technologies are evolving to meet this need.

BENEFITS OF P25

P25 has many various benefits in performance, efficiency, capabilities and quality. Key P25 technology benefits include:

Interoperability

Radio equipment that is compatible with P25 standards will allow users from different agencies or areas to communicate directly with each other. This will allow agencies on the federal state/provincial or local level (or any other agency) to communicate more effectively with each other when required (emergencies, law enforcement, etc.)

The APCO Project 25 Interface Committee (APIC) has formed the Compliance Assessment Process and Procedures Task Group (CAPPTG) to ensure that P25 equipment and systems comply with P25 standards for interoperability, conformance, and performance regardless of the manufacturer and in accordance with the User Needs Statement of Requirements.

Multiple Vendors

The P25 open standard will allow competing products from multiple vendors to be interoperable. This will allow customers of the P25 product to benefit from multiple manufacturing sources (decreased costs, open bidding, non-proprietary systems).

Backwards Compatibility

A basic requirement for Phase 1 P25 digital radio equipment is backward compatibility with standard analog FM radios. This supports an orderly migration into mixed analog and digital systems, enabling users to gradually trade out radios and infrastructure equipment. By selecting products and systems that comply with P25 standards, agencies are assured that their investment in the latest technology has a clear migration path for the future.

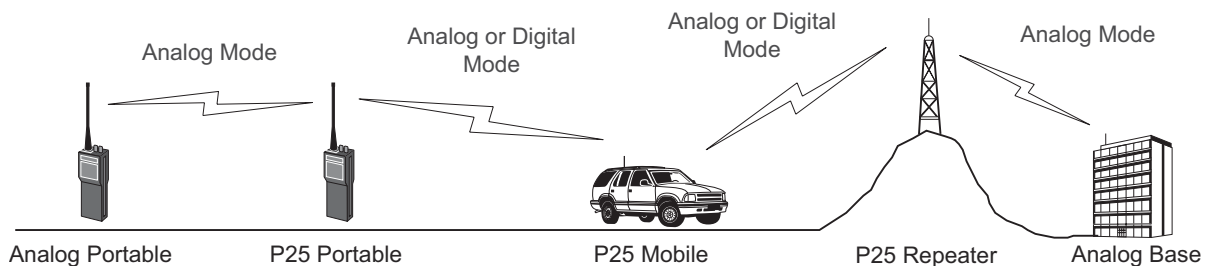

Figure 1-5: P25 Backwards Compatibility

P25 radios operate in analog mode to older analog only radios, and either analog or digital mode to other P25 radios.

Phase 2 P25 radio systems will include a Phase 1 conventional mode for backwards compatibility with Phase 1 P25 equipment.

Encryption Capability

The P25 standard includes a requirement for protecting digital communications (voice and data) with encryption capability. The encryption used in P25 is optional, allowing the user to select either clear (un-encrypted) or secure (encrypted) digital communication methods. The encryption keys also have the option of being re-keyed by digital data over a radio network. This is referred to as Over The Air Re-keying (OTAR). This capability allows the radio systems manager to remotely change encryption keys.

Spectrum Efficiency

P25 maximizes spectrum efficiency by narrowing bandwidths.

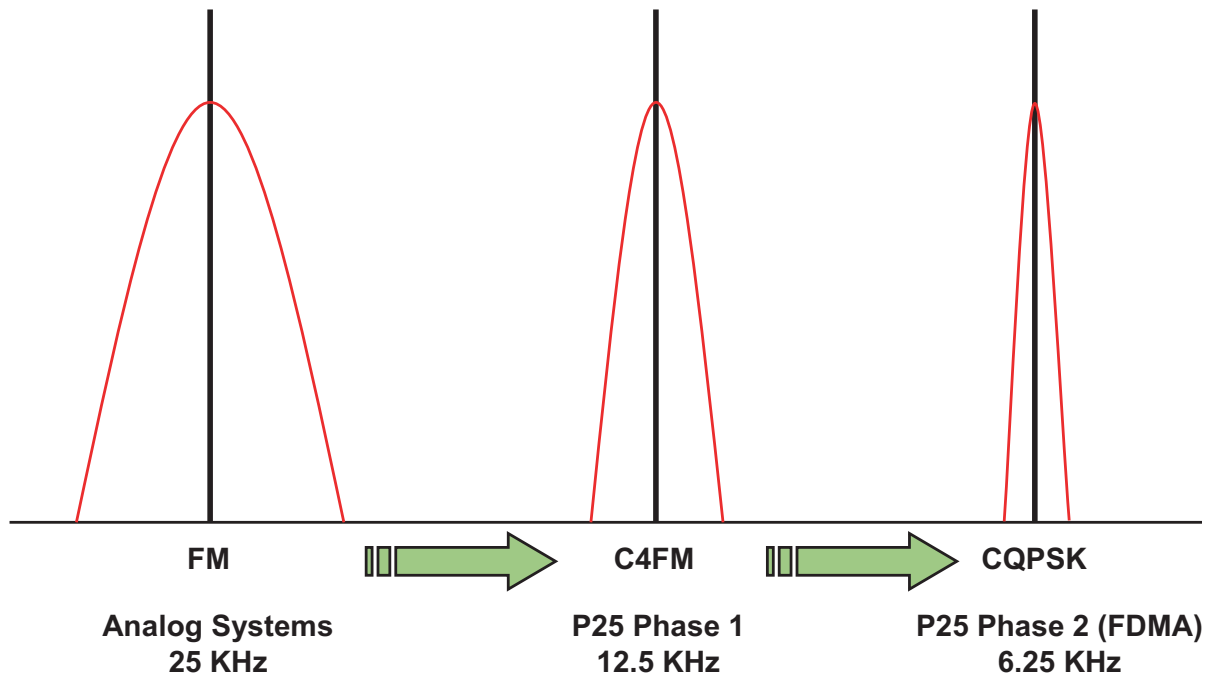

Figure 1-6: P25 Spectrum Efficiency

The RF spectrum is a finite resource used by every country in the world. Spectrum efficiency frees up more channels for radio system use.

Improved Audio Quality

With 2800 bits per second of the total 9600 bits per second channel capacity allocated to error correction, P25 digital signals have improved voice quality over standard analog signals, especially at low or noisy RF carrier levels. The IMBE™ voice coder converts voice information into digital data and then the data is protected using error correction codes. The error correction is able to correct for small errors in the received signal. Since the audio is digitally encoded, the background noise typically present in analog systems is also removed.

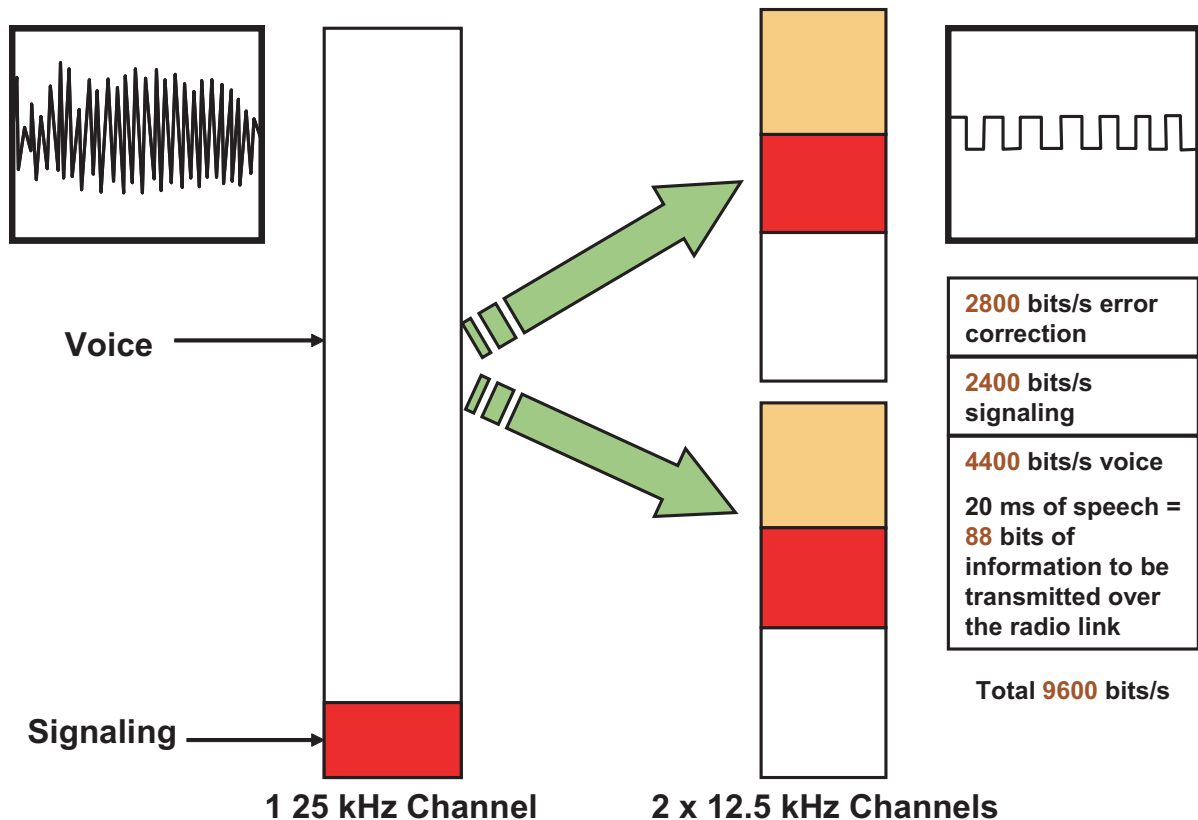

Figure 1-7: Analog to P25 Channel Comparison

Enhanced Functionality

P25 radio systems use 2400 bits per second for signaling and control functions. The signaling capabilities include selective calling (Source and Destination ID), talk groups (TGID), network (repeater) access codes (NAC) and emergency flags all as standard P25 digital features.

Other P25 signaling includes; Manufacturers identification codes (MFID) which uniquely identifies different manufacturers to customize radio capabilities, Low Speed Data for user applications, encryption keys and algorithms for secure transmission and many other standard signaling formats.

OTHER DIGITAL STANDARDS

Although P25 is the focus of this document, it is important to understand that there are many different digital radio standards in use around the world. P25 has primarily been adopted for use in North America, while another leading digital standard, TETRA (Terrestrial Trunked Radio) has primarily been adopted for use in Europe.

While P25 and TETRA appear to be the two leading digital Land Mobile Radio standards in the world today, there are other digital, spectrally-efficient radio systems that have been submitted to the International Telecommunication Union's Radiocommunication Sector's (ITU-R) Study Group 8 and its Working Party 8A.

ITU-R is charged with determining the technical characteristics and operational procedures for a growing range of wireless services. The Radiocommunication Sector also plays a vital role in the management of the radio-frequency spectrum. Study Group 8 and its Working Party 8A is responsible for studies related to the land mobile service, excluding cellular, and to the amateur and amateur-satellite services.

Digital radio systems can operate using different channel access methods such as FDMA (Frequency Division Multiple Access), TDMA (Time Division Multiple Access), or other methods (FHMA - Frequency Hopping Multiple Access).

Project 25, Tetrapol, and EDACS® (Enhanced Digital Access Communications System) Aegis™ are three different FDMA systems. TETRA, DIMRS (Digital Integrated Mobile Radio System), and IDRA (Integrated Digital Radio) are three different TDMA systems.

Project 25

The United States submitted Project 25 to ITU-R Working Party 8A. It includes a family of two modulation methods, C4FM and CQPSK. C4FM fits within a 12.5 kHz channel mask and uses constant-envelope modulation (i.e., does not require a linear or linearized amplifier). CQPSK fits within a 6.25 kHz channel mask but does require the use of either a linear or linearized amplifier. Both trunked and conventional (non-trunked) operation is provided for.

Tetrapol

France submitted Tetrapol to ITU-R Working Party 8A. It uses a constant-envelope modulation technique that fits within a 10 kHz channel mask. Systems are in use in a number of countries in Europe and around the world. EADS is the principal manufacturer of this equipment.

EDACS® Aegis™

L.M. Ericsson AB (with support from the Swedish Administration) submitted EDACS® Aegis™ to ITU-R Working Party 8A. It uses a constant-envelope modulation technique and has four different selectable levels of deviation and filtering that can result in the signal fitting within 25 kHz and 12.5 kHz channel masks. Systems are in use in a number of countries around the world. M/A-COM, Inc. is the principal manufacturer of this equipment.

TETRA

A number of European countries submitted TETRA to ITU-R Working Party 8A on behalf of ETSI (the European Telecommunication Standards Institute). TETRA's primary mode uses $\pi/4$ DQPSK modulation that requires a linear or linearized amplifier and fits four-slot TDMA within a 25 kHz channel mask.

DIMRS

Canada submitted DIMRS to ITU-R Working Party 8A. It is a six-slot TDMA system using 16QAM modulation that fits within a 25 kHz channel mask. It is designed primarily for public systems and is in use in a number of countries around the world. Motorola Inc. is the principal manufacturer of this equipment, under the name IDEN™.

IDRA

Japan submitted IDRA to ITU-R Working Party 8A. It also is a six-slot TDMA system using 16QAM (16 point Quadrature Amplitude Modulation) that fit within a 25 kHz channel mask. A major difference from DIMRS is the use of a different vocoder.

FHMA

Israel submitted FHMA to ITU-R Working Party 8A. The system primarily makes use of frequency hopping and sectorized base station antennas to gain spectrum efficiency. The signals are error protected and when a radio is at a sector boundary, due to different frequency hop patterns between sectors, interference to and from nearby radios in the other sector is minimized.

Although the other digital standards seem to work well for their original intentions, APCO felt that these standards would not meet all of the requirements for a public safety agency within North America. P25 standards were designed primarily for the public safety user, with range and performance given very high priority. Also, unique flexibility has been designed into the standards to enhance interoperability, privacy, gradual phase-in of new technologies, and the reliable transmission of voice and data.



CHAPTER 2: P25 INTERFACE STANDARDS

P25 STANDARDS – GENERAL SYSTEM MODEL

This section will introduce the reader to the P25 General System Model and the P25 interface standards that are integral to the P25 radio systems.

There are currently more than thirty technical documents in the Phase 1 set of P25 standards. The Telecommunications Industry Association (TIA) developed these standards through well defined user input. The P25 users continue to enlarge a Statement of Requirements while the industry develops the standards for those requirements and the Project 25 Steering Committee verifies their adherence to the users' needs. The P25 documents have also been approved by the American National Standards Institute (ANSI®) as ANSI® standards. This is the ultimate recognition in the United States of the utility and support of a technology as a standard.

The individual documents describe component interfaces needed to build systems. Depending upon the type of system the user needs, individual documents are available that detail how standardized elements can make up a standardized system. These systems can be trunked or conventional, they can be voice only, data only or voice and data, and they can be clear or encrypted.

The P25 standards are contained in the TIA-102 suite of documents. Copies of the standards documents may be purchased through Global Engineering Documents by commercial entities. Public agency users can get a copy of all of the documents on a CD-ROM from the National Communications System (NCS). NCS is the standards arm of the U.S. Department of Defense. Copies may also be obtained from the Department of Justice, National Institute of Justice (NIJ) Standards and Technology Group. NIJ is a primary advocate and supporter of the Project 25 process.

P25 defines six interfaces to an RF Sub-System (RFSS), one peripheral interface, and one over-the air interface. These are shown in Figure 2-1 the P25 General System Model. Within the RFSS, all equipment is unique to a single manufacturer. An example of a closed interface within the RFSS is the interface between a trunking controller and its base station. Each of the open interfaces shown in Figure 2-1 is defined in a TIA document.

The Inter Sub-System Interface (ISSI), Network Management Interface, Fixed Station Interface, and Console Interface are being developed. It is TIA's intention to standardize these equipment sub-system interfaces whenever practical. The ISSI, console, and fixed station interfaces are based on the use of Internet Protocol (IP).

The general system model of a P25 compliant digital radio system defines the system elements plus intra-system and inter-system interfaces and naming conventions of these elements and interfaces.

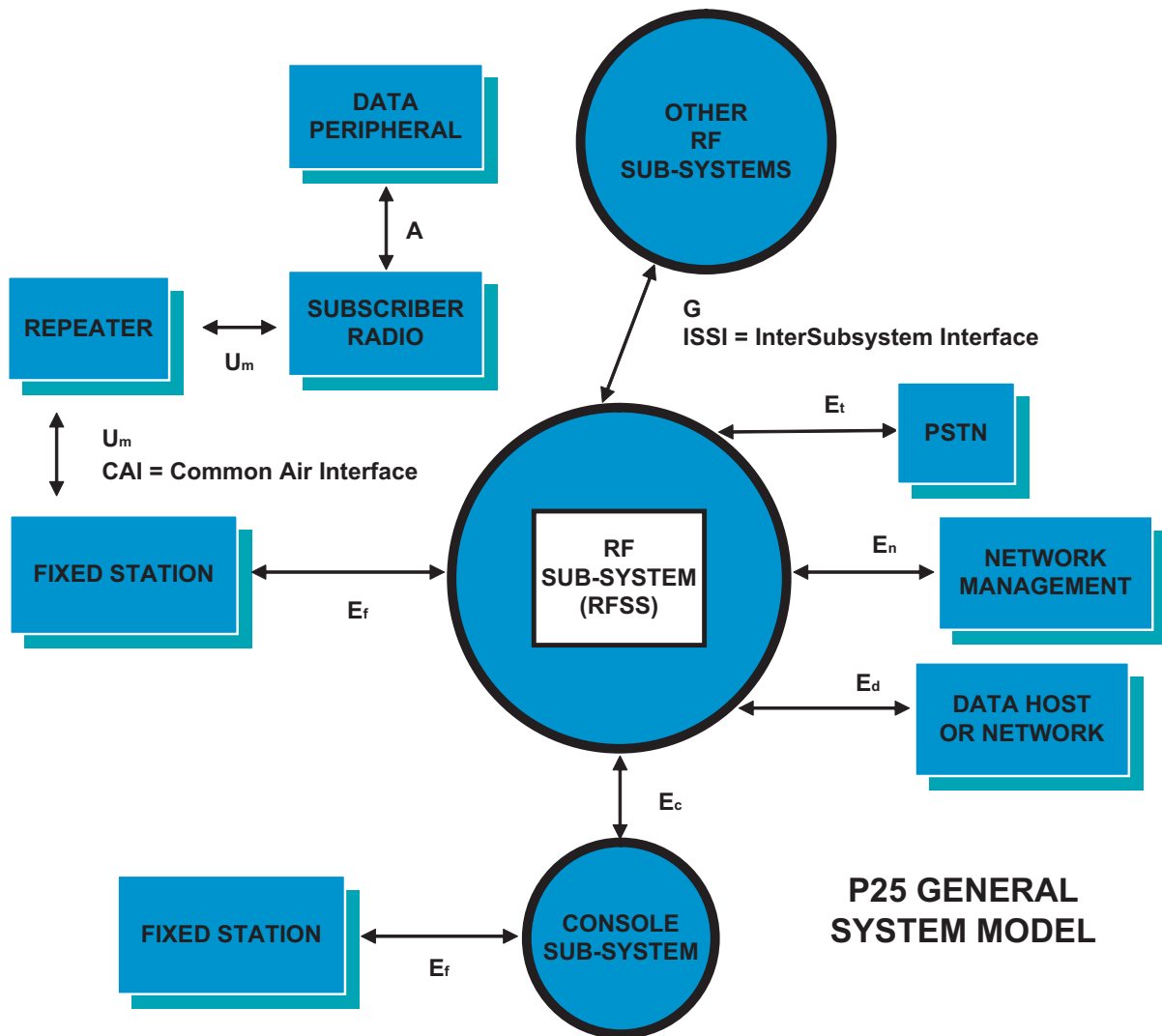

Figure 2-1: P25 General System Model

The P25 Interface Standards as shown on the General System Model are as follows:

RF Sub-System (RFSS)	Core Infrastructure
Common Air Interface (Um)	Radio to radio protocol
Inter Sub-System Interface (ISSI _g)	RFSS to all other system interconnections (In progress)
Telephone Interconnect Interface (Et)	PSTN to RFSS definition
Network Management Interface (En)	Network to RFSS definition (In progress)
Data Host or Network Interface (Ed)	Computer aided dispatch to RFSS definition
Data Peripheral Interface (A)	Radio to Data Peripheral definition
Fixed Station Interface (Ef)	Base station to RFSS / Console Sub-System definition (in progress)
Console Sub-System Interface (Ec)	Console to RFSS definition (In progress)

RF SUB-SYSTEM

The P25 interfaces bound the RF Sub-System (RFSS) infrastructure. The RF Sub-System can be made from any collection of site equipment (single station/site or multiple station/site), whose only requirement is that the equipment supports the Common Air Interface, and contains all necessary control logic to support the open intersystem interfaces and call processing. The RF Sub-Systems are the building blocks for wide-area system construction and will connect with any other configuration of equipment or RF Sub-Systems.

COMMON AIR INTERFACE

The Common Air Interface (Um) or CAI defines a standard (or reference point) at which communications between P25 radios can take place. The CAI is the core element of the P25 standard that assures the ability of one company's P25 digital radio to communicate with another company's P25 digital radio. Communications between P25 radios are done at a gross bit rate of 9.6 kbps and with FDMA channel access. Several processes take place to convert information for transmission. The Common Air Interface uses an IMBE™ voice coder (vocoder) to convert (compress) speech to a digital format for communication. This voice information is then protected with error correction coding to provide protection over the channel. The voice information and error correction is then transmitted with additional encryption information, unit identification, and low speed data to fully utilize the 9.6 kbps of channel capacity in the Common Air Interface.

A breakdown of the information contained in the Common Air Interface can be found in Chapter 4: Anatomy of the Common Air Interface. Chapter 7 contains some detailed information on the operation and theory of the IMBE™ Vocoder.

INTER SUB-SYSTEM INTERFACE

The Inter Sub-System Interface (G) is under development.

The Inter Sub-System Interface (G) or ISSI permits multiple RF Sub-Systems to be interconnected together into wide-area networks. The ISSI defines a multi-channel digital interface supporting standard protocols to enable interoperability utilizing mobility management and wide-area service support functionality. The interface is designed to give system designers the flexibility to combine any number of RF Sub-Systems of any size. The Inter Sub-System Interface also provides a common meeting place for RF Sub-Systems of different technologies (TDMA, FDMA, micro-cell) and different RF bands. This interface is optional, and need only be supported when intercommunication amongst and across RFSS's of Land Mobile Radio systems is desired.

Although a P25 subscriber radio may only operate freely among systems with the standard P25 common air interface, the P25 ISSI has the potential to connect between different radio or telecommunications networks as long as they also support the ISSI interface.

The ISSI messaging defines the basic structures to be shared among all equipped RFSS's. The ISSI can be supported on any possible networking configuration, from a simple star configuration to a full mesh, to an intelligent network. This can consist of private links and network support, or may be public links and network support configured as a private network. Any intervening network supporting the information of an ISSI link needs to preserve the ISSI messaging packet, but may intermediately represent the ISSI packet in whatever convenient form (e.g. ATM cell) is available.

The ISSI will support:

-
- mobility and data management,
-
- wide area service control,
-
- service transport,
-
- end to end protection of signaling information,
-
- trunking.
-
- other network interconnection.
-

TELEPHONE INTERCONNECT INTERFACE

P25 requires an open interface to telephone networks. The Telephone Interconnect Interface (Et) supports both analog and ISDN telephone interfaces, providing for selective use of proven standard telephone interfaces currently in use.

The Telephone Interconnect Interface defines a 2-wire loop start and a 2-wire ground start connection between the RF Sub-System and the PSTN or a PABX. In addition, other optional interfaces may be provided. The Telephone Interface deals only with voice service because it has been assumed that circuit connected data services would access a telephone network via a modem and connect to a data port on the radio system.

NETWORK MANAGEMENT INTERFACE

The Network Management Interface (En) is under development.

The Network Management Interface defines a network management interface to all RF Sub-Systems. According to a single selected network management scheme within any RF Sub-System, all five classical elements of network management must be supported. It is expected that a network management scheme will be selected that will bring with it the ability to manage RF Sub-Systems with available network management system equipment. In addition, an existing network management system, including computer and telecommunications equipment, may well be able to encompass P25 radio systems.

DATA HOST OR NETWORK INTERFACE

The Data Host or Network Interface (Ed) defines four different types of data connectivity. These include a native open interface for connecting host computers, as well as the requirement to support three different types of existing computer network interfacing (TCP/IP, SNA and X.25).

DATA PERIPHERAL INTERFACE

The Data Peripheral Interface (A) defines protocols by which mobile and portable subscriber units will support a port through which laptops, terminals, or subscriber unit peripherals may be connected. It is required that the supported open interface protocols are passed transparently into X.25, SNA, or TCP/IP computer networks at another open interface on the fixed equipment side. Transparency is listed as a requirement, and it is expected that application layer standards emerge for the connection of various peripheral devices.

FIXED STATION INTERFACE

The Fixed Station Interface provides for communication between a Fixed Station (FS) and either an RF Sub-System (RFSS) or a Console Sub-System.

The Fixed Station Interface defines a set of mandatory messages, supporting analog voice, digital voice (clear or encrypted), and data (under development). These messages will be of a standard format passed over the interface. Manufacturers can enhance this functionality using manufacturer specific messages.

The Conventional Fixed Station Interface (CFSI), which is a specialization of the Fixed Station Interface, has been defined. A breakdown of the information contained in the CFSI can be found in Chapter 5: Conventional Fixed Station Interface.

The CFSI defines both an Analog Fixed Station Interface (AFSI) and a Digital Fixed Station Interface (DFSI). Either one of these interfaces can be used to connect to a fixed station operating in analog, digital or mixed mode.

The AFSI configuration is 2 or 4-wire audio with E&M or Tone Remote Control.

The DFSI configuration is an IP based interface. The physical interface is an Ethernet 100 Base-T with an RJ45 connector. The DFSI utilizes UDP for control information and RTP on UDP for voice information. Digital voice information is IMBE™ and analog voice information is PCM audio.

CONSOLE SUB-SYSTEM INTERFACE

The Console Sub-System Interface (Ec) is under development.

The Console Sub-System Interface (CSSI) defines a multi-channel digital interface. This interface is capable of supporting standard protocols to enable interoperable support functionality. The CSSI defines basic messaging structures to interface a console sub-system to an RFSS.

The CSSI can be supported using a variety of networking technologies and topologies, from a simple star configuration to an intelligent backbone network. The networks may be private, or public networks configured as private networks.

The physical interface is an Ethernet 100 Base-T with an RJ45 connector. The CSSI will support Ethernet 10 Base-T and 1000 Base-T as an optional physical interface. The CSSI will optionally support auto-sensing. Other interfaces may be installed as a manufacturer's option.

As a note, a console sub-system can connect directly to a fixed station and support one or more Fixed Station Interfaces. Manufacturers may also optionally support a subset of the Data Host or Network Interface in the Console.

The Console Sub-System Interface is a sub-set of the fixed station interface. Any device connected at these points will arbitrate to determine the type of connection.



CHAPTER 3: P25 PRACTICAL APPLICATIONS

ANALOG TO P25 TRANSITION

P25 equipment can be used in any configuration that is typically found in existing analog systems. Base Stations, remote bases, repeaters, voting, and simulcast systems are all configurations of P25 conventional systems. Transmitter RF power output levels and receiver sensitivity levels of P25 equipment are very similar to those of conventional analog equipment. P25 equipment can therefore be used in a “one-for-one replacement” scenario of analog equipment. This section will discuss some of the issues surrounding the transition from an analog radio system to a P25 digital radio system as well as supply general knowledge about P25 radio systems.

P25 FREQUENCY BANDS

The frequency bands in which P25 radio systems are available are VHF (136 – 174 MHz) and UHF (403 – 512 MHz, 806 – 870 MHz). In addition, P25, Phase 1 technology has been adopted by the FCC as the digital interoperability standard for the 700 MHz (746 – 806 MHz) digital public safety band.

HEXADECIMAL AND BINARY NUMBERING

The TIA-102 suite of documents defines numerical information in either hexadecimal format or binary format. The hexadecimal numbers are preceded by a \$ symbol and the binary numbers are preceded by a % symbol.

P25 DIGITAL CODE DEFINITIONS

A P25 digital radio system uses many different codes, identifications, indicators and other digital information in the Common Air Interface. Some of the codes are user accessible or programmable, while others are meant for internal use inside of the CAI, or for specific applications.

Frame synchronization

A special sequence of 48 bits marking the location of the first bit of the message provides frame synchronization. Frame synchronization occurs at the beginning of every message (voice and data), and is inserted every 180 ms throughout the voice message. This allows receivers to pick up voice messages after the message has begun (late entry of receivers). Late entry can occur when a subscriber unit selects a channel (or talk group) while there is already an active signal present. The subscriber unit was not active when the transmission started, but is added when it detects the repeated frame sync function. The frame synchronization is not accessible or programmable by the user.

(See Chapter 4; Figure 4-3)

Network ID (NID)

Every P25 data unit packet contains the 64 bit NID field. The NID is composed of a 4 bit Data Unit ID and a 12 bit NAC code. The NID is protected with a primitive BCH Code and a single parity bit is added to fill out the NID code word to 64 bits.

(See Chapter 4; Figure 4-3)

Data Unit ID

The NID contains the 4 bit Data Unit ID field. The Data Unit ID is used to determine the “type” of packet information (eg. Header Data Unit, Logical Link Data Unit 1, etc.). The Data Unit ID is not accessible or programmable by the user.

(See Chapter 4; Figure 4-3)

Network Access Code (NAC)

The NID contains the 12 bit NAC field. NAC codes are user programmable and are typically used to control network access but may also be used to steer repeater functions. NAC codes are used the same way as an analog CTCSS tone (or DCS code). NAC codes minimize co-channel interference and allow repeater addressing by keeping the receiver squelched unless a signal with a matching NAC arrives.

The NAC code's 12-bit field ranges from hexadecimal \$000 to \$FFF and contains 4096 addresses (significantly more than the standard CTCSS and DCS tones).

The following NAC codes have specific functions:

\$293	specified as the default NAC value.
\$F7E	a receiver set for NAC \$F7E will unsquelch on any incoming NAC.
\$F7F	a repeater receiver set for NAC \$F7F will allow all incoming signals to be repeated with the NAC intact.

(See Chapter 4; Figure 4-3)

CTCSS to NAC Conversion

Early TIA documents specified a formula for converting analog CTCSS tones and DCS codes to specific NAC codes. Those documents have since been removed and the selection of NAC codes has been left to the user. Some government agencies have defined a conversion table for their own use for translating CTCSS to NAC codes (eg. State of California and others).

Shown below is the early TIA conversion table from CTCSS to NAC codes. These codes were determined by taking the CTCSS frequency and multiplying it by ten, then converting the integer result to a hexadecimal number.

CTCSS to NAC code conversion chart

CTCSS	NAC Code	CTCSS	NAC Code
67.0 Hz	\$29E	136.5 Hz	\$555
69.3 Hz	\$2B5	141.3 Hz	\$585
71.9 Hz	\$2CF	146.2 Hz	\$5B6
74.4 Hz	\$2E8	151.4 Hz	\$5EA
77.0 Hz	\$302	156.7 Hz	\$61F
79.7 Hz	\$31D	162.2 Hz	\$656
82.5 Hz	\$339	167.9 Hz	\$68F
85.4 Hz	\$356	173.8 Hz	\$6CA
88.5 Hz	\$375	179.9 Hz	\$707
91.5 Hz	\$393	186.2 Hz	\$746
94.8 Hz	\$3B4	192.8 Hz	\$788
97.4 Hz	\$3CE	203.5 Hz	\$7F3
100.0 Hz	\$3E8	206.5 Hz	\$811
103.5 Hz	\$40B	210.7 Hz	\$83B
107.2 Hz	\$430	218.1 Hz	\$885
110.9 Hz	\$455	225.7 Hz	\$8D1
114.8 Hz	\$47C	229.1 Hz	\$8F3
118.8 Hz	\$4A4	233.6 Hz	\$920
123.0 Hz	\$4CE	241.8 Hz	\$972
127.3 Hz	\$4F9	250.3 Hz	\$9C7
131.8 Hz	\$526		

Status Symbols

Throughout the Data Units, 2 bit status symbols are interleaved so that there is one status symbol for every 70 bits of information. The status symbols allow repeaters to indicate the status of the inbound channels to subscribers. The repeaters assert the status symbols on both voice and data messages, indicating inbound activity for both voice and data calls.

The subscribers set the value of the status symbol to signify an Unknown status in their messages since they are unable to indicate the status of any inbound channel.

There are 4 possible values for the status symbol; 01 (for busy), 11 (for idle), 00 (unknown, used by talk-around) and 10 (unknown, used for inbound or outbound). Repeaters use status symbols 01 and 11, and subscribers use status symbols 00 and 10.

There is one value for Busy (01), one for Idle (11), and two values to indicate Unknown status. When the subscriber sends a message on a direct channel, it will use the Unknown value for direct mode operation (00). When the subscriber sends a message inbound to a repeater, it will use the Unknown value for repeater operation (10).

Status Symbols are used on a P25 trunking system for subscriber access to the inbound control channel using the Slotted ALOHA technique. The Status Symbols are transmitted on the outbound control channel, and the subscriber uses them to identify the slot boundaries for the inbound control channel.

The reference oscillator stability for repeaters and base stations is often better than for subscriber radios. Subscribers may compare the frequency of their local reference oscillator with the carrier frequency from a repeater or base station transmitter, in order to adjust and improve their local reference oscillator. This adjustment is called Automatic Frequency Control (AFC). AFC operation is anticipated by the FCC regulations for the 746-806 MHz band. Subscribers may detect a repeater or base station transmission by checking the values of the status symbols on slot boundaries. A repeater or base station will transmit Busy or Idle indications on slot boundaries. When a subscriber detects these values, it can average enough data symbols from a transmission to obtain an estimate of the carrier frequency used by the repeater or base station. It can then compare this to the receiver local oscillator to determine any frequency corrections to improve local reference stability. After the repeater or base station stops transmitting, the subscriber units will be in an unlock state. AFC locking resumes when a repeater or base station restarts its transmissions.

Status Symbols are not widely used at this time, however there are many possible uses for them in the future (such as data / voice priority).

(See Chapter 4; Figure 4-3)

Manufacturer's ID (MFID)

The Header Code Word and Link Control Word (LDU1) contain the 8 bit MFID field. When the manufacturer uses non-standard (data only) features, the MFID is asserted. When all of the other information fields conform to the Common Air Interface definitions, the MFID has a standard value of \$00 or \$01. A P25 radio must, as a minimum, transmit or receive messages using the the standard values for the MFID field. As a minimum, a P25 receiver will ignore messages which do not contain the standard values for the MFID field. Every manufacturer is assigned an MFID that can be used for proprietary signaling. Non-standard data from one manufacturer may not pass through another manufacturers repeater system.

The MFID's that have been assigned are:

\$10	Relm / BK Radio
\$20	Cycomm
\$28	Efratom Time and Frequency Products, Inc
\$30	Com-Net Ericsson
\$38	Datron
\$40	Icom
\$48	Garmin
\$50	GTE
\$55	IFR Systems
\$60	GEC-Marconi
\$68	Kenwood Communications
\$70	Glenayre Electronics
\$74	Japan Radio Co.
\$78	Kokusai
\$7C	Maxon
\$80	Midland
\$86	Daniels Electronics Ltd.
\$90	Motorola
\$A0	Thales
\$A4	M/A-COM
\$B0	Raytheon
\$C0	SEA
\$C8	Securicor
\$D0	ADI
\$D8	Tait Electronics
\$E0	Teletec
\$F0	Transcrypt International

(See Chapter 4; Figure 4-4, Figure 4-6 and Figure 4-11)

Algorithm ID (ALGID)

The Header Code Word and Encryption Synchronization (LDU2) contain the 8 bit ALGID field. The ALGID identifies the encryption algorithm used in the P25 system. The ALGID is entered through a Key Management Facility or Key Loader when entering encryption keys.

The ALGID's that have been defined for Type 1 algorithms are:

\$00	ACCORDION 1.3
\$01	BATON (Auto Even)
\$02	FIREFLY Type 1
\$03	MAYFLY Type 1
\$04	SAVILLE
\$41	BATON (Auto Odd)
\$80	Unencrypted message (no encryption algorithm)
\$81	DES-OFB encryption algorithm
\$82	2-key triple DES encryption algorithm
\$83	3-key triple DES encryption algorithm
\$84	AES encryption algorithm

(See Chapter 4; Figure 4-4 and Figure 4-7)

Key ID (KID)

The Header Code Word and Encryption Synchronization (LDU2) contain the 16 bit KID field. The KID identifies the specific encryption key for use when multiple encryption keys have been loaded into the encryption modules. The KID is also used for single encryption key systems. The typical default KID for clear or secure systems is \$0000. The KID is entered through a Key Management Facility or Key Loader when entering encryption keys.

(See Chapter 4; Figure 4-4 and Figure 4-7)

Message Indicator (MI)

The Header Code Word and Encryption Synchronization (LDU2) contain the 72 bit MI field. The MI is the initialization vector (synchronization for key stream generator) for a Type 1, Type 2, Type 3 or Type 4 encryption algorithm. Clear messages are denoted \$00000000 while secure (encrypted) messages are variable. The Message Indicator is not accessible or programmable by the user.

(See Chapter 4; Figure 4-4 and Figure 4-7)

Talk-group ID (TGID)

The Header Code Word and Link Control Word (LDU1) contain the 16 bit TGID field. The TGID identifies the talk-group for the message. The purpose of a talk group is to allow logical groupings of radio users into distinct organizations. The TGID could also be used to minimize co-channel interference and allow subscriber addressing.

The TGID ranges from hexadecimal \$0000 to \$FFFF and contains 65,536 addresses.

The following TGID's have specific functions:

\$0001 specified as the default TGID value and should be used in systems where no other talk groups are defined.

\$0000 no-one or a talk group with no users. Used when implementing an individual call.

\$FFFF reserved as a talk group which includes everyone.

(See Chapter 4; Figure 4-4 and Figure 4-6)

Low Speed Data

Each Logical Link Data Unit in a voice message contains the 16 bit Low Speed Data field. The Low Speed Data is intended for custom user applications not defined by the CAI (possibly GPS location data, infrastructure status information, etc.) and has a total capacity of 88.89 bps. The Low Speed Data is encoded with a shortened cyclic code to create 64 bits per superframe.

(See Chapter 4; Figure 4-6 and Figure 4-7)

Unit ID

The Unit ID is a 24 bit user programmable field that is used for both group and individual calling. The Unit ID is used as both a Source ID (from the sending unit) and a Destination ID (in the receiving unit in an individual call).

The Unit ID is different from the Electronic Serial Number (ESN) embedded in the radio. The ESN is only programmable by the manufacturer of the radio.

The Unit ID ranges from hexadecimal \$000000 to \$FFFFFF and contains 16,777,216 addresses. The Unit ID's should be programmed into the radios using a national, corporate or agency wide unit identification scheme.

The following Unit ID's have specific functions:

\$000000	no-one. This value is never assigned to a radio unit
\$000001 to \$98967F	for general use.
\$989680 to \$FFFFFFE	for talk group use or other special purposes.
\$FFFFFFF	designates everyone. Used when implementing a group call with a TGID.

Source ID

The Link Control Word (LDU1) contains the 24 bit Source ID field. The Source ID is the Unit ID of the SENDING unit. The Source ID is typically sent in all voice messages and is used for both group and private calling.

(See Chapter 4; Figure 4-6)

Destination ID

The Link Control Word (LDU1) contains the 24 bit Destination ID field. The Destination ID is used for private voice messages only (called private or individual calling). The Destination ID is the Unit ID of the intended recipient of the individual call.

(See Chapter 4; Figure 4-6)

Emergency indicator

The Link Control word (LDU1) contains the 1 bit Emergency indicator field. The Emergency indicator is embedded in group voice messages to indicate an emergency condition.

The emergency indicator bit is designed to be selectable by a switch or programming in the subscriber units. The emergency indicator bit can be set as follows:

%0	routine, non-emergency condition
%1	emergency condition

(See Chapter 4; Figure 4-6)

Link Control Format

The Link Control Format is an 8 bit field contained in the Link Control Word (LDU1). The Link Control Format is used to specify content of the Link Control Word. The Link Control Format is not accessible to the user.

(See Chapter 4; Figure 4-6)

Packet Data Unit Digital Codes

There are other digital codes used in the Packet Data Unit such as the Service Access Point Identifier (SAP Identifier), Full Message Flag (FMF), etc. These digital codes are defined in more detail in Chapter 4: Anatomy of the Common Air Interface.

P25 VOICE MESSAGE OPTIONS

P25 Radio Systems process voice messages in a variety of modes. P25 radio systems operate in both P25 digital mode and conventional analog mode. Voice messages can be sent over a 12.5 KHz bandwidth analog channel using standard analog call procedures with analog signaling (CTCSS, DCS, etc.). Some manufacturers also have equipment that will allow operation in 25 KHz analog bandwidth.

P25 voice messages can also be sent in P25 digital mode. P25 voice messages can be sent in either encrypted (secure) or unencrypted (clear) mode. The secure / clear operation is typically an option that is required to be installed in the subscriber units.

There are 3 methods to send a voice message, with several options and variations of each case. Each of these 3 methods of sending a voice message can operate in clear or secure mode.

The three main types of voice message calls are:

Routine Group Call	This is the most common type of call and is intended for a group of users within the radio system. This type of call is typically initiated by asserting the PTT switch.
Emergency Group Call	This type of call is similar to a Routine Group Call, but is used during an emergency condition. An emergency condition is defined by the radio system users. This type of call is typically initiated by asserting the Emergency switch.
Individual Call	This type of call is addressed to a specific individual. The caller enters the subscribers Unit ID, that they wish to call, and this is used as the Destination ID by the radio making the call. This type of call is made after the Destination ID is entered into the radio.

The P25 transmitter has sufficient controls to support the three main types of voice messages. These controls are as follows:

PTT Switch - The Push-To-Talk switch is pressed when the user wishes to transmit and released when the transmission is over.

Channel Selector - The Channel Selector allows the user of the radio to select a radio's mode of operation. The Channel Selector controls the following parameters of the radio:

1. Frequency
2. NAC
3. TGID
4. Other (eg. selecting the encryption key)

Emergency Switch - The Emergency switch will allow the user to assert the emergency condition. Once asserted, the emergency condition remains active until cleared by some other means (eg. turning the radio off).

Numeric Keypad / Display - The Numeric Keypad / Display will allow the user to set numeric parameters (eg. the Destination ID in an individual call).

Routine Group Call Procedure

- NAC and TGID are set by the user (Channel Selector).
 - MFID is set to standard value for CAI transmission.
 - MI, ALGID, and KID are set by secure or clear mode parameters.
 - Emergency bit is set to indicate non-emergency call.
 - Source ID is the Unit ID of the radio.
-

Emergency Group Call Procedure

- NAC and TGID are set by the user (Channel Selector).
 - MFID is set to standard value for CAI transmission.
 - MI, ALGID, and KID are set by secure or clear mode parameters.
 - Emergency bit is set to indicate an emergency call.
 - Source ID is the Unit ID of the radio.
-

Individual Call Procedure

- The Unit ID of the user to be called is entered into the radio and this is the Destination ID.
 - TGID is set to the null talk group of \$0000
 - NAC is set by the user (Channel Selector).
 - MFID is set to standard value for CAI transmission.
 - MI, ALGID, and KID are set by secure or clear mode parameters.
-

P25 DATA APPLICATIONS

P25 supports the transfer of data over the air (by the Common Air Interface) in the form of data packets. Some Data applications include Over The Air Rekeying (OTAR) of encrypted radios, Trunking System Control Channel messages, and user data applications such as GPS, Alarm Monitoring and System Status.

CONVENTIONAL CONTROL MESSAGES

The TIA-102 documents define a number of control messages for trunking systems that can be applied to conventional systems. These control messages use Packet Data Units to transfer information, and may be optionally implemented by a manufacturer.

The messages are as follows:

Emergency Alarm

Emergency Alarm is activated by a user to inform the dispatcher an emergency situation is encountered. The Emergency Alarm is typically used in a life threatening situation.

Call Alert

Call Alert sends a data packet to the destination subscriber identifying the source of the Call Alert and requesting the destination to contact the source. Call Alert is typically used if the destination subscriber did not respond to a voice message from the source.

Radio Check

Radio Check is used to determine if a specific subscriber is currently available on the radio system. A response to the Radio Check is required, or the system will assume the subscriber is not available.

Radio Inhibit (Radio Uninhibit)

Radio Inhibit is used to deny all calls between the inhibited subscriber and the RFSS. Radio Uninhibit cancels the inhibit status of the subscriber.

Status Update and Status Request

Status Update is used by a subscriber to indicate its current status (user and unit status) to a designated target address. Status Request is used by a subscriber to request the current status of a specified subscriber.

Message

A Message may be sent by a subscriber or the RFSS to send a short message to another subscriber.

Telephone Interconnect Dialing

Telephone Interconnect Dialing will allow a subscriber to initiate a Unit to PSTN call, and will allow a telephone network to initiate PSTN to Group and PSTN to Unit calls.

Radio Unit Monitor

Radio Unit Monitor is used to cause a subscriber radio to key up when requested to do so by a dispatcher. Radio Unit Monitor allows a dispatcher to listen to activity at the location of the subscriber.

P25 ENCRYPTION

P25 Encryption applies to both trunking and conventional systems, as well as voice messages and data packets. The IMBE™ vocoder produces a digital bit stream for voice messages that is relatively easy to encrypt. Major advantages of the P25 encryption design are that encryption does not affect speech intelligibility nor does it affect the system's usable range. Both of these advantages are major improvements over encryption previously used in analog systems.

Encryption requires that both the transmitting and the receiving devices have an encryption key, and this key must be the same in each unit. This may be done using a Key Loader. Most P25 subscriber equipment is optionally available with the capability of storing and using multiple keys. That is, a unit could use one key for one group of users and use a separate key for another group of users. System management of keys may be done in a Key Management Facility, or KMF.

In the U.S. there are four general "types" of encryption algorithms. Type 1 is for U.S. classified material (national security), Type 2 is for general U.S. federal interagency security, Type 3 is interoperable interagency security between U.S. Federal, State and Local agencies, and Type 4 is for proprietary solutions (exportable as determined by each vendor and the U.S. State Department). The CAI supports use of any of the four types of encryption algorithms. P25 documents currently standardize two different Type 3 encryption processes. One encryption process is the U.S. Data Encryption Standard, or DES algorithm, which uses 64 bit Output Feed Back and is denoted as DES-OFB. Another encryption process is the Advanced Encryption Standard (AES) which is a 256 bit algorithm.

P25 also includes a standardized Over The Air Rekeying (OTAR) function. OTAR is a way to greatly increase the utility of encryption systems by allowing transfer of encryption keys via radio. This remote rekey ability, controlled from a Key Management Facility, or KMF, means that radios no longer have to be physically touched in order to install a new or replacement key into a radio. OTAR signaling is sent as Packet Data Units over the Common Air Interface.

Optionally, multiple encryption keys can be stored in P25 radio equipment. In order to identify the keys, they are stored with an associated label called a Key Identifier or KID. The type of algorithm to be used with the key is identified by an Algorithm ID or ALGID.

To be able to decrypt messages, the receiver decryption module software must be in the same state as the transmitter encryption module software. The CAI provides space for up to 72 bits of this synchronization information in the Message Indicator (MI) vector at the beginning of the message (in the header), and periodically during the message in the LDU2 portion of the voice superframe.

AES and DES-OFB encryption solutions were tested and verified by an accredited National Institute of Science and Technology (NIST) laboratory as compliant with the security requirements of the Federal Information Processing Standard (FIPS).

ANALOG VS. P25 DIGITAL COVERAGE

There is much discussion about the RF coverage area of an analog radio signal versus a digital radio signal. In theory, a P25 digital radio signal will allow for a slightly greater coverage area when placed in the same location as an analog radio. There are some factors, however, that may interfere with the digital signal to a greater degree than the interference to an analog signal.

P25 Phase 1 uses C4FM modulation. Because C4FM is a constant amplitude modulation, it allows use of nonlinear power amplifiers. Use of nonlinear amplifiers results in digital equipment that produces RF power levels that are equal to the power levels of current analog equipment. Systems can be implemented with little or no loss of coverage. An analog transmitter can be replaced with a P25 Phase 1, digital transmitter that produces the same transmitter output level of the analog transmitter. This is currently not necessarily true for higher power analog systems that are replaced by some TDMA systems when bandwidth of the resultant signal is a critical issue.

In order to occupy a limited bandwidth, some TDMA systems use modulations that require linear power amplifiers and system transmitter power in these systems can be a significant issue. GSM™, for example, uses a 200 kHz wide channel for 8 voice slots, and uses the fixed amplitude GMSK modulation. TETRA on the other hand, uses 4 slots in a 25 kHz wide channel, and TETRA uses DQPSK that contains amplitude and phase components to the modulation. By using a linear amplifier, the variable amplitude modulation implementations produce a relatively lower output power. Their higher data rate also tends to limit the coverage area because of the bit rate and the resultant bit timing. This can result in a much larger infrastructure to support TDMA systems as opposed to the Phase 1 FDMA systems. FDMA also promotes use of a very reliable direct mode of operation because of the power levels of subscriber equipment and the lack of a requirement for any supporting infrastructure. This direct, or talk around, mode insures reliable unit-to-unit operation without the need for any infrastructure. Again, because of the use of non-linear power amplifiers, portable and mobile radio transmitter power of P25 digital equipment is comparable to the power level available in current FM analog equipment.

Since the RF power output levels of current FM analog and P25 digital equipment are equal, it would seem that digital coverage and analog coverage are equal. This is not true, as much more of the covered area is usable when sending a P25 digital signal. The signal-to-noise ratio in the subscriber unit is a critical element of analog systems. P25 signals attempt to correct for noise-induced errors, with the built in error correction, so that fringe areas that were not clearly audible in analog systems have a good chance of being loud and clear with P25 digital.

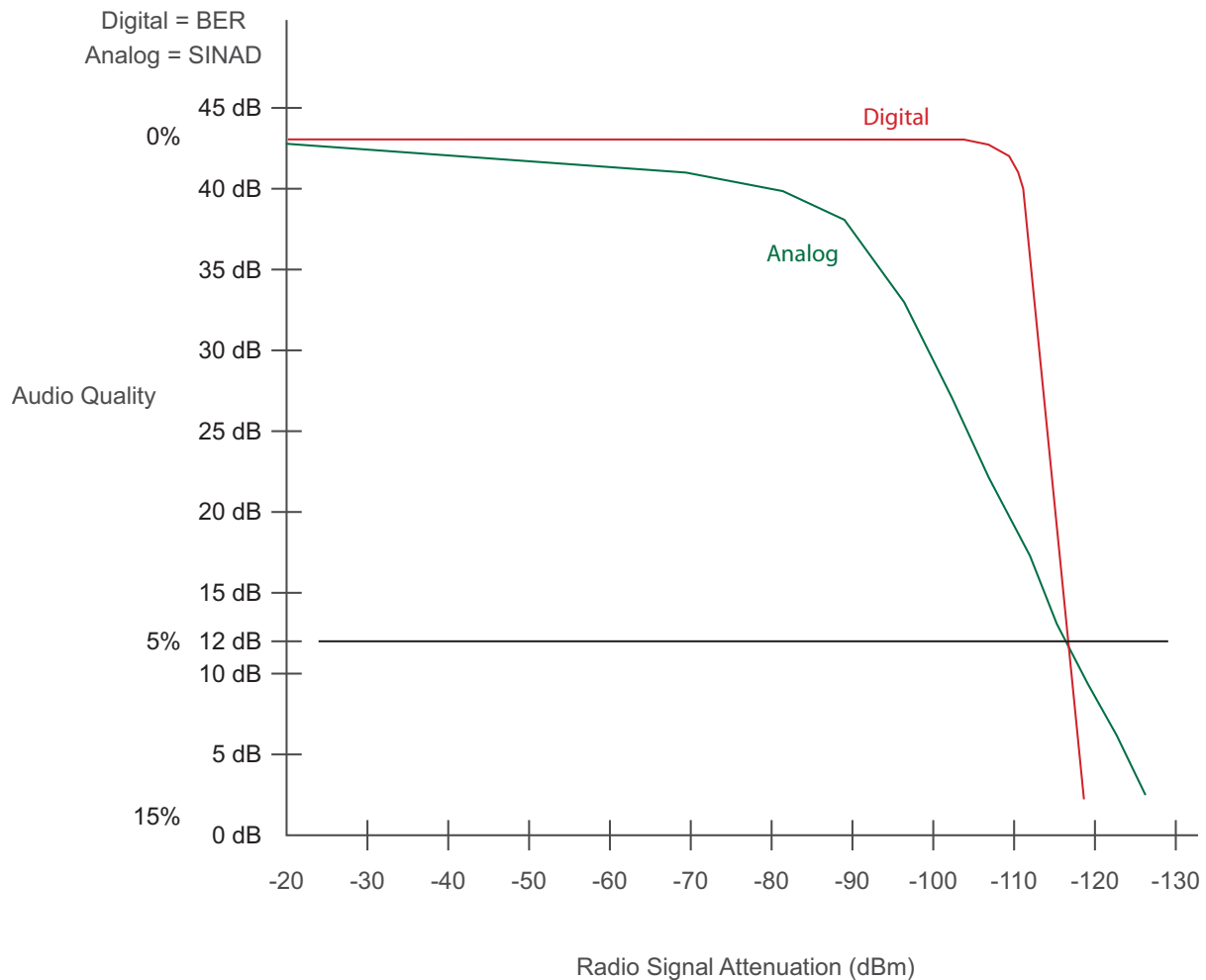

Figure 3-1: Analog vs. Digital Audio Quality

Although it appears that the digital radio signal performs with greater coverage area than an analog radio signal, other factors must also be taken into consideration, such as multipath reflections. Multipath reflections of the RF carrier occurs when two or more signals of the same origin arrive at the receive antenna delayed in time because they traveled different path lengths or because of reflections and scattering in the propagation environment. This deterioration of the signal must be considered when planning coverage areas.

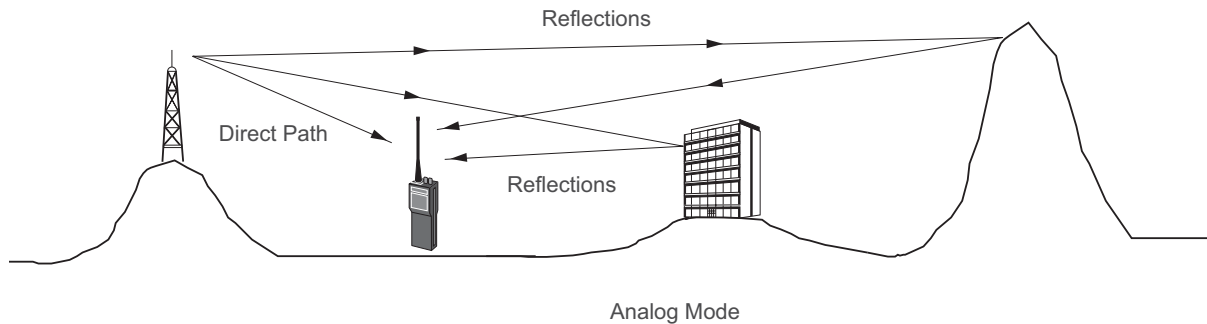

Figure 3-2: The Effects of Multipath

RF multipath is a frequency dependant problem with higher frequencies being more vulnerable. When a subscriber radio is in motion, multipath interference results in the amplitude modulation effect familiar to mobile FM listeners as “picket fencing”. In the worst case, when the subscriber radio is stopped in a signal null, the signal is severely degraded and a single, strong specular reflection may completely cancel the transmitted signal. Where analog reception can become noisy, digital signals could be lost altogether. Increasing power is not a viable remedy because both the direct and reflected signal will increase proportionally, preserving the interference nulls.

Coverage studies

Many different agencies and organizations such as the federal government, state departments, fire departments and other public safety organizations have conducted studies on analog and digital propagation of RF communication systems and publish their studies online or in magazines. These studies are typically specific to the type of communications systems the organization uses and the environment they are deployed in. While these studies are extremely useful, they usually compare different communication systems (eg. digital trunking vs. simplex analog).in different RF propagation environments.

P25 RADIO SYSTEM PERFORMANCE TESTING

Testing a P25 radio system is very similar to testing an analog system for the majority of tests to be performed. In many cases, the radio system can be tuned in analog mode, and then the accuracy of the digital mode can be tested to ensure compliance.

The following are some radio system tests that can be performed on P25 radio systems in analog or digital mode:

Analog Receiver Reference Sensitivity

Analog Receiver Reference Sensitivity is a measure of the amount of minimum RF signal level that is required to produce an intelligible audio signal when an FM signal is demodulated. Analog Reference Sensitivity measurements can be made with any P25 receiver in analog mode.

The measurement device used in analog systems is typically the SINAD meter which shows a ratio in dB of:

$$\frac{\text{Signal} + \text{Noise} + \text{Distortion}}{\text{Noise} + \text{Distortion}}$$

Digital Receiver Sensitivity (BER)

Digital Receiver Sensitivity is a measure of the amount of RF signal level that is required to produce an intelligible audio signal when a C4FM signal is demodulated. Digital Sensitivity measurements can be made with any P25 receiver in digital mode.

Sensitivity in a digital radio system is expressed in terms of Bit Error Rate (BER). BER is the percentage of received bits in error to the total number of bits transmitted. The Digital Sensitivity test must be conducted with a known test signal such as the Standard 1011 pattern. The radio is typically placed into a special test mode for this test and radio specific software and a computer may be required to evaluate a decoded 1011 patterns Bit Error Rate.

Audio Levels and Distortion

Audio Level and Audio Distortion readings can be performed in both analog mode and digital mode. The measurements are made using the same procedure as for conventional analog equipment. In digital mode, the audio level readings are performed before vocoding in the transmitter, and the audio level and distortion readings are performed after de-vocoding in the receiver.

Audio Frequency Measurements

FM audio frequency measurement is done with a standard frequency counter. C4FM audio frequency measurements cannot be accurately measured.

RF Power Measurements (FM and C4FM)

RF Power measurements for Digital C4FM and Analog FM can be made with a standard peak detecting power meter. C4FM digital transmissions are the same as FM transmission in that they are of constant amplitude.

Analog FM Modulation Accuracy

A deviation meter is used to measure Analog FM Modulation Accuracy. The deviation meter monitors peak carrier movement above and below the carrier center frequency and displays the average offset. Various IF Bandwidth filters are required to ensure accurate measurements.

Digital Modulation Accuracy (Modulation Fidelity)

Modulation fidelity is the degree of accuracy between the actual modulation and the ideal theoretical modulation.

Modulation fidelity is determined by taking deviation measurements synchronously with the decoded symbol clock and averages the measurements over a group of symbols to calculate a percentage of error. The measured deviation is only important at symbol time. This test requires specific test patterns to be generated from the transmitter.

Common Air Interface Protocol Testing

CAI Protocol testing requires the ability to decode and encode the 9600 baud data to and from voice and data information. The decoding and encoding capability allows for verification of the radio programming, testing emergency conditions, talk groups, and repeater accessing codes off the air.

P25 VS. ANALOG DELAY TIMES

Delay times between legacy analog equipment and P25 digital equipment may vary.

In order to understand the different delay times, the following definitions for an analog system are as follows (from TIA-603-C):

Receiver Attack Time

Receiver attack time is the time required to produce audio power output after application of a modulated input signal.

Carrier Attack Time

Transmitter carrier attack time is the time required to produce 50% of steady-state carrier output power after changing the state of the transmitter from standby to transmit.

If an analog system uses CCTSS decode and / or encode the following definitions are applicable (from TIA-603-C):

Receiver Audio Attack Time (CTCSS)

The receiver audio attack time is the elapsed time between the application of a receiver input signal 12 dB above the reference sensitivity modulated with the standard test modulation and standard subaudible modulation, and the time that the audio voltage at the receiver output is greater than 90% of its rated output.

Encoder Response Time (CTCSS)

The encoder response time is the elapsed time from the moment the push-to-talk control circuit is activated at the transmitter until the CTCSS tone at the output of the transmitter has reached 90% of maximum voltage.

According to TIA-603-C an analog system could have a maximum Receiver Attack Time of 150 ms (250 ms if CTCSS is used) and a maximum Transmitter Attack Time of 100 ms (150 ms if CTCSS is used). In most analog systems the attack times are significantly lower than these values (especially if the system does not have CTCSS).

The following definitions for a P25 system are as follows (from TIA-102.CAAA-A):

Receiver Late Entry Unsilence Delay

The late entry unsilence delay is the time it takes for a receiver to detect the frame synchronization and network ID on a digital message and generate an audio output. The test is performed for late entry, which means that the synchronizing preamble (Header Data Unit) is absent from the message, and the receiver must detect frame synchronization during the middle of the message. This test applies to a transceiver in the conventional mode of operation.

Transmitter Power and Encoder Attack Time

Transmitter power and encoder attack time is the time required for a transmitter to prepare and transmit information on the radio channel after changing state from standby to transmit. This test applies to a transceiver in the conventional mode of operation.

According to TIA-102.CAAB-B, a P25 system could have a maximum Receiver Unsilence Delay of up to 460 ms (if both talk groups and encryption is used) and a maximum Transmitter Power and Encoder Attack Time of 100 ms (50 ms Power Attack Time; 100 ms Encoder Attack Time). Receiver Unsilence Delay can be reduced to a maximum of 370 ms if only the talk group OR encryption is used (not both). If neither talk groups nor encryption is used the maximum Receiver Unsilence Delay is 125 ms. In most P25 systems the attack times are relatively close to these maximum values.

P25 Radio Systems also specify a Throughput Delay as follows (from TIA-102.CAAA-B):

Receiver Throughput Delay

Receiver throughput delay is the time it takes for a receiver to produce an audio output following the introduction of a tone test pattern.

Transmitter Throughput Delay

The transmitter throughput delay is the time it takes for audio changes in the microphone to be encoded and transmitted over the air.

Throughput delays are separate from attack times. Throughput delays assume that the equipment is already powered and operational. TIA-603-C does not specify an audio throughput delay for analog systems, as the throughput delay is typically negligible. P25 radio systems require much more processing time (Digital Signal Processing, Vocoding, etc.) and typically have much greater throughput delays than conventional analog.

An example of P25 maximum throughput delays is shown below:

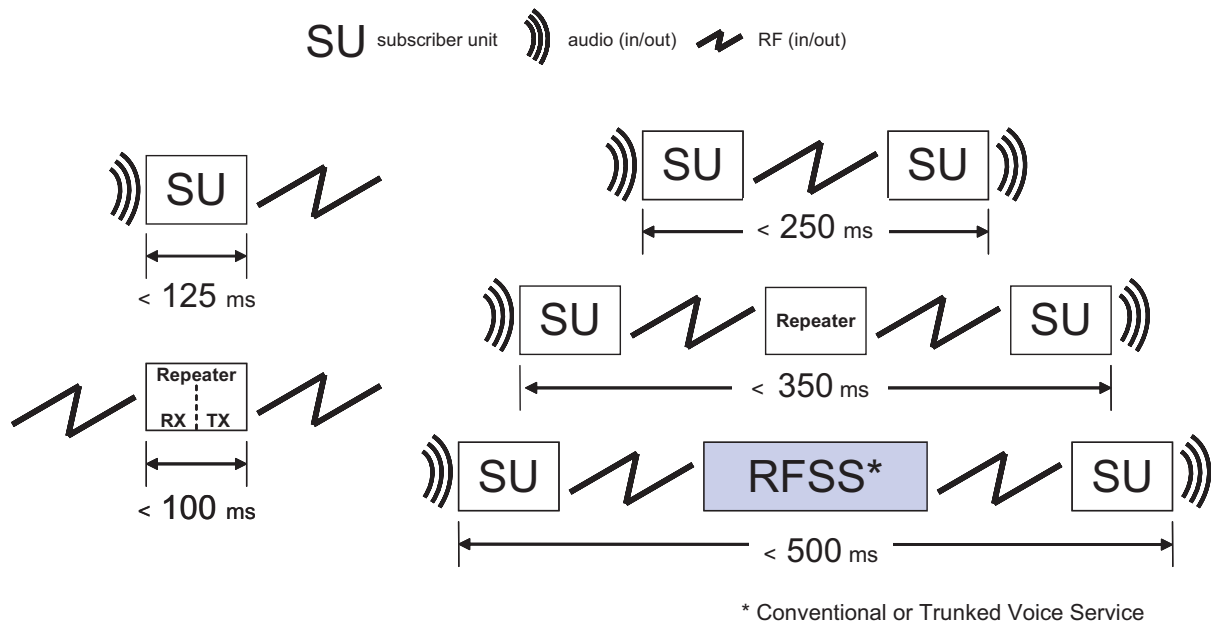

Figure 3-3: Conventional Voice Service Throughput Delays

P25 Radio Systems will have either a slight or great increase in the delays experienced by the user over legacy analog systems, depending on the system infrastructure (more infrastructure to pass the signal through equals more delay). System users may require re-training to accommodate for the greater delays.



CHAPTER 4: ANATOMY OF THE COMMON AIR INTERFACE

VOICE

The P25 standard requires the use of the IMBE™ Vocoder to encode speech (tone and audio level) into a digital bit stream. The IMBE™ digital bit stream is broken into voice frames where each voice frame is 88 bits in length (representing 20 ms of speech). The voice frames are protected with error correction codes which add 56 parity check bits resulting in an overall voice frame size of 144 bits. The voice frames are grouped into Logical Link Data Units (LDU1 and LDU2) that contain 9 voice frames each. Each Logical Link Data Unit is 180 ms in length and can be consecutively grouped into Superframes of 360 ms. The superframes are repeated continuously throughout the voice message after a Header Data Unit has been sent. Additional information (encryption, Link Control information and Low Speed Data) is interleaved throughout the voice message.

The voice message structure for a P25 CAI voice transmission is shown in Figure 4-1. The voice message begins with a Header Data Unit (to properly initialize any encryption and link control functions for the message), and then continues with Logical Link Data Units or LDUs. The LDUs alternate until the end of the voice message. The end of the message is marked with a Terminator Data Unit. The Terminator Data Unit can follow any of the other voice data units.

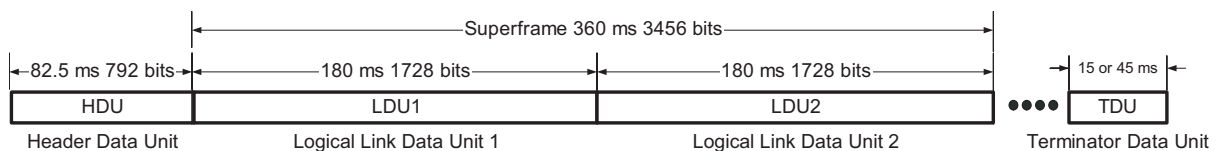

Figure 4-1: P25 Voice Message Structure

DATA

Data messages are transmitted over the P25 CAI using a packet technique. The data information is broken into fragments, packets and blocks are then error coded and sent as a single packet called a Packet Data Unit. The Packet Data Unit can be of varying lengths and includes a header block that contains the length of the data message.

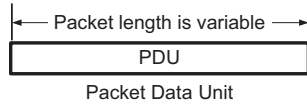
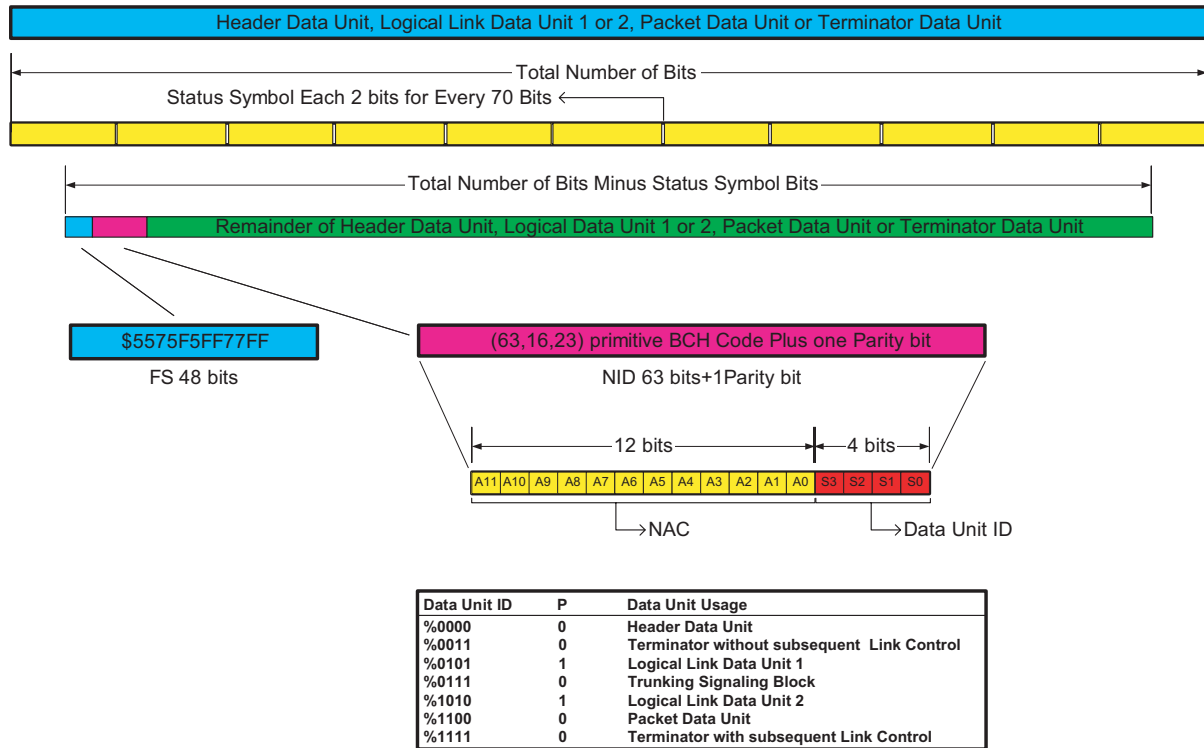

Figure 4-2: P25 Data Message Structure

FRAME SYNCHRONIZATION AND NETWORK IDENTIFIER

Each data unit (Header Data Unit, Logical Link Data Unit 1, Logical Link Data Unit 2, Packet Data Unit and Terminator Data Unit) begins with a Frame Synchronization (FS) and Network Identifier (NID).



The P bit is the last (64-th) parity bit in the code word.

Figure 4-3: Frame Synchronization and Network Identifier

STATUS SYMBOLS

Throughout all of the data units (Header Data Unit, Logical Link Data Unit 1, Logical Link Data Unit 2, Packet Data Unit and Terminator Data Unit) the 2 bit status symbols are interleaved so that there is one status symbol for every 70 bits of information.

Status Symbol	Meaning	Usage
01	Inbound Channel is Busy	Repeater
00	Unknown, use for talk-around	Subscriber
10	Unknown, use for inbound or outbound	Repeater or Subscriber
11	Inbound Channel is Idle	Repeater

HEADER DATA UNIT

A diagram of the header data unit is given in Figure 4-4. The Header Data Unit is composed of the FS (48 bits), NID (64 bits), and the header code word (648 bits). Ten null bits are added to the end of the header code word resulting in 770 bits. Eleven status symbols are also interleaved throughout the Header Data Unit yielding 792 bits total. The Header Data Unit takes 82.5 ms to transmit at 9.6 kbps (the standard bit rate of the P25 CAI).

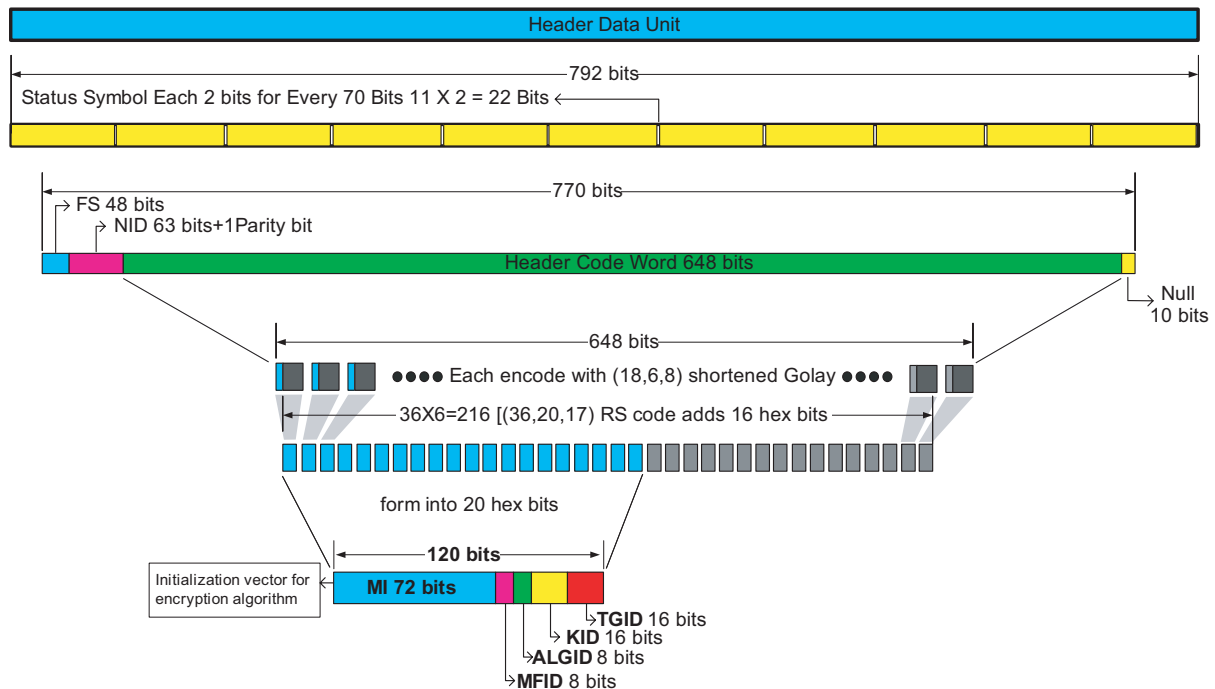

Figure 4-4: Header Data Unit

The Header Code Word field includes a **Message Indicator** (MI), and **Algorithm ID** (ALGID) for the encryption algorithm, and the **Key ID** (KID) for the encryption key as well as the **Manufacturer's ID** (MFID) and **Talk-group ID** (TGID). These information fields total 120 bits.

The information fields are separated into 20 symbols of 6 bits each (these are called hex bits). The symbols or hex bits are encoded with a (36,20,17) Reed-Solomon code to yield 36 hex bits. The 36 hex bits are then encoded with a (18,6,8) shortened Golay code to yield 648 bits total.

VOICE CODE WORDS

The IMBE™ vocoder converts speech into a digital bit stream where the bit stream is broken into voice frames of 88 bits in length for every 20 ms of speech. This corresponds to a continuous average vocoder bit rate of 4.4 kbps. Voice frames consist of 8 information vectors, labelled u_0, u_1, ... u_7.

Voice frames are encoded into a 144 bit voice code word as follows:

The voice frame bits are rated according to their effect on audio quality and are then protected using Golay and Hamming codes. The 48 most important bits (u_0 through u_3) are error protected with four (23,12,7) Golay code words. The next 33 most significant bits (u_4 through u_6) are error protected with three (15,11,3) Hamming code words. The last 7 least significant bits (u_7) are not error protected. Construction of the IMBE™ digital bit stream into voice code words is given in Figure 4-5.

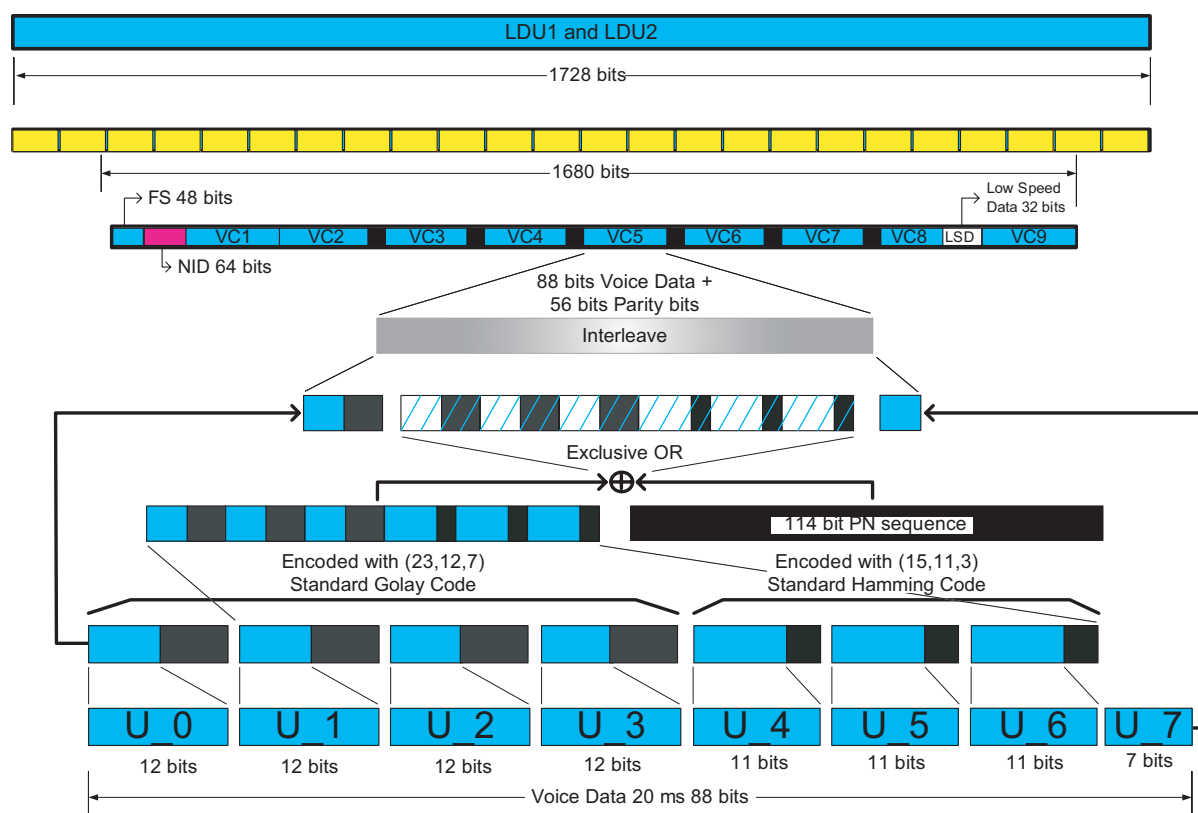

Figure 4-5: Voice Code Word

After the voice data has been error protected using the Golay and Hamming codes, a 114 bit pseudo random sequence (PN sequence) is generated from the 12 bits of u_0. The error protected voice data in u_1 through u_6 is then bit-wise exclusive-ored with the PN sequence. This information is then interleaved throughout the voice frame to resist fades.

LOGICAL LINK DATA UNIT 1

A diagram of Logical Link Data Unit 1 (LDU1) is given in Figure 4-6. LDU1 is the first half of a superframe. LDU1 is composed of the FS (48 bits), NID (64 bits), nine voice code words, numbered VC1 through VC9 (1296 bits), Link Control Word (240 bits) and Low Speed Data (32 bits). Twenty-Four Status Symbols are also interleaved throughout LDU1 yielding 1728 bits total. LDU1 takes 180 ms to transmit at 9.6 kbps (the standard bit rate of the P25 CAI).

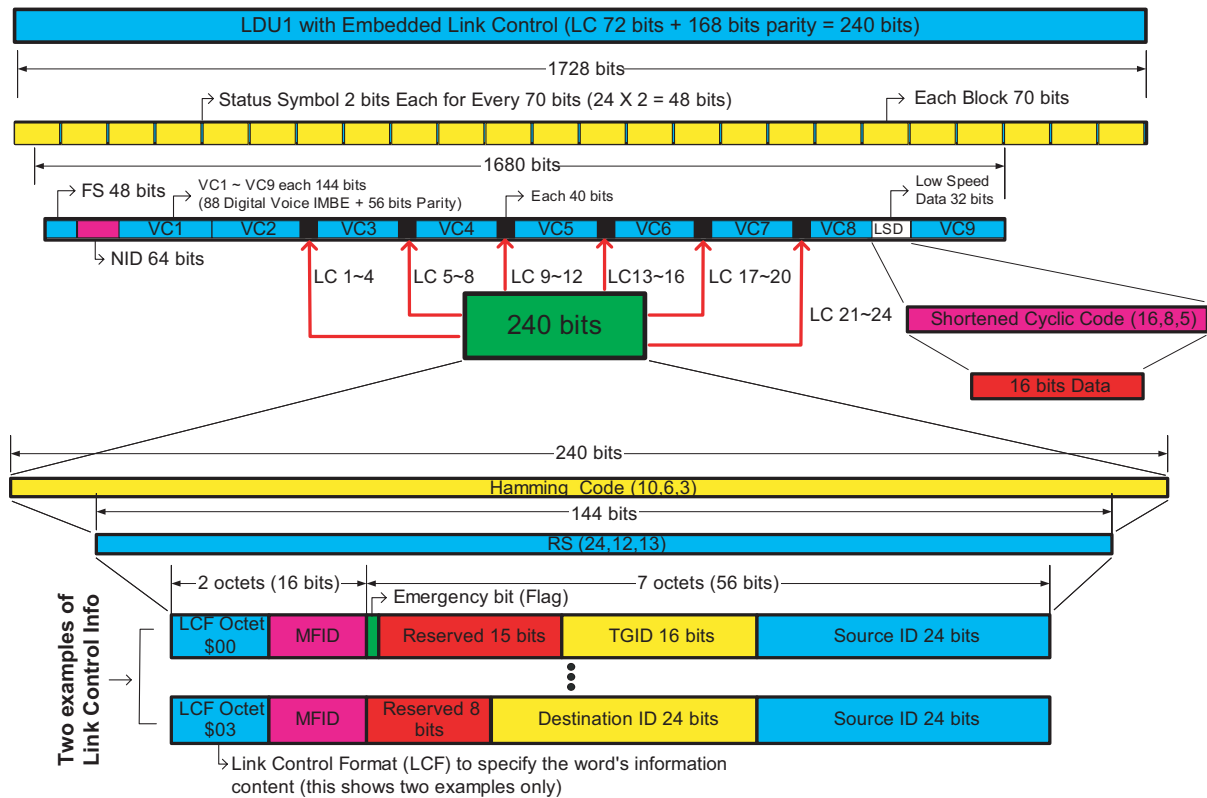

Figure 4-6: Logical Link Data Unit 1

The Link Control Word field may include a **Talk-group ID (TGID)**, a **Source ID**, a **Destination ID**, an **Emergency** indicator, a **Manufacturer's ID (MFID)** and any other necessary call ID information. The Link Control Word uses a variable format since there is too much information for a fixed field format. The type of format is identified by the **Link Control Format (LCF)**. The LCF specifies the the content of the Link Control Word's information. Two format examples are diagrammed in Figure 4-6. All of the information fields (including the LCF) total 72 bits.

The Link Control Word is constructed by serializing the information into 12 hex bits and then encoding them with a (24,12,13) RS code to yield 24 hex bits. The 24 hex bits are then encoded with a (10,6,3) shortened Hamming code to yield 240 bits total. The 240 bits of Link Control (LC) information is then inserted in between the voice code words (VC2 to VC8) in blocks of 40 bits (LC 1-4 is a block of 40 bits, etc.).

LOGICAL LINK DATA UNIT 2

A diagram of Logical Link Data Unit 2 (LDU2) is given in Figure 4-7. LDU2 is the second half of a superframe. LDU2 is composed of the FS (48 bits), NID (64 bits), nine voice code words, numbered VC10 through VC18 (1296 bits), Encryption Sync Word (240 bits) and Low Speed Data (32 bits). Twenty-Four Status Symbols are also interleaved throughout LDU1 yielding 1728 bits total. LDU2 takes 180 ms to transmit at 9.6 kbps (the standard bit rate of the P25 CAI).

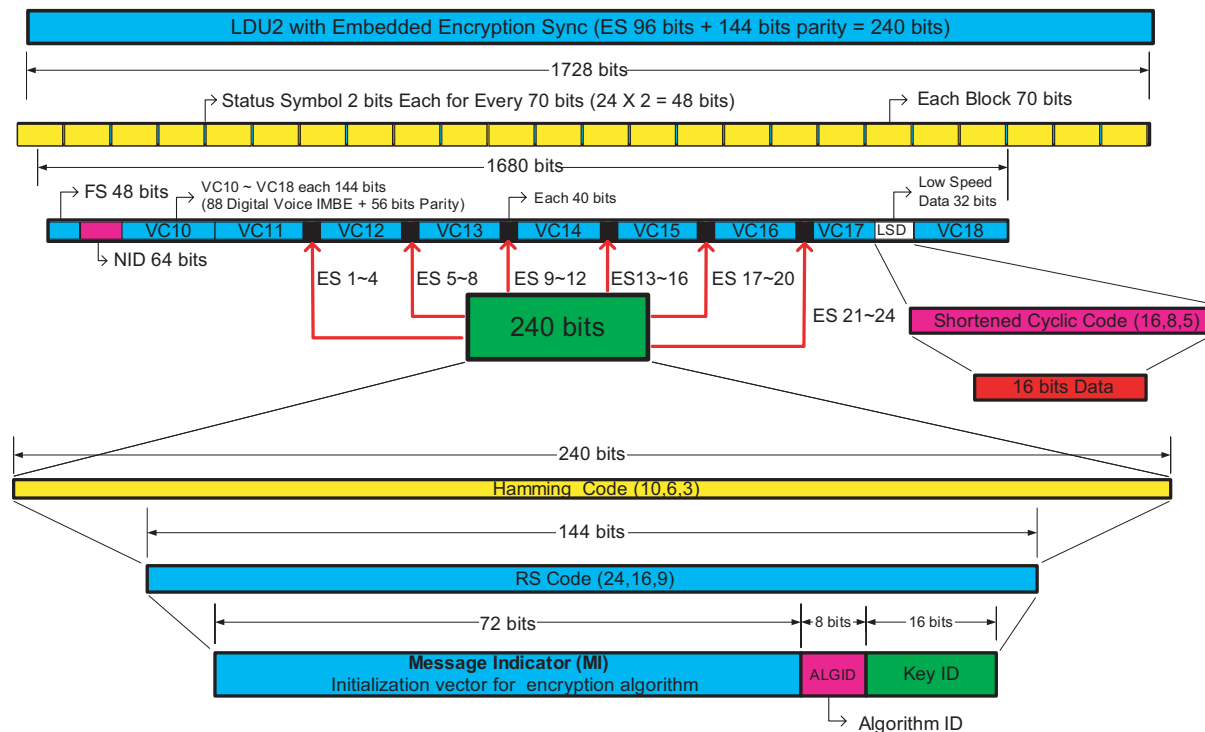

Figure 4-7: Logical Link Data Unit 2

The Encryption Sync Word field includes the **Message Indicator (MI)**, **Algorithm ID (ALGID)** for the encryption algorithm, and the **Key ID (KID)** for the encryption key. This information may be used to support a multi-key encryption system, but is also used for single key and clear messages.

The Encryption Sync Word is constructed by serializing the information into 16 hex bits and then encoding them with a (24,16,9) RS code to yield 24 hex bits. The 24 hex bits are then encoded with a (10,6,3) shortened Hamming code to yield 240 bits total. The 240 bits of Encryption Sync (ES) information is then inserted between the voice code words (VC11 to VC17) in blocks of 40 bits (ES 1-4 is a block of 40 bits, etc.).

LOW SPEED DATA

Low Speed Data is a serial stream of information. This information is provided for custom applications that are not defined in the CAI. Low Speed Data is comprised of 32 bits of data, 16 bits of which are inserted between VC8 and VC9 in LDU1 and 16 bits are inserted between VC17 and VC18 in LDU2. Each group of 16 bits is encoded with a (16,8,5) shortened cyclic code, creating 32 bits total in each LDU. Low Speed Data has a total capacity of 88.89 bps.

TERMINATOR DATA UNIT

Voice messages may use one of two different Terminator Data Units. The simple Terminator Data Unit is composed of the FS (48 bits), NID (64 bits), and Null bits (28 bits). A diagram of the simple Terminator Data Unit is given in Figure 4-8.

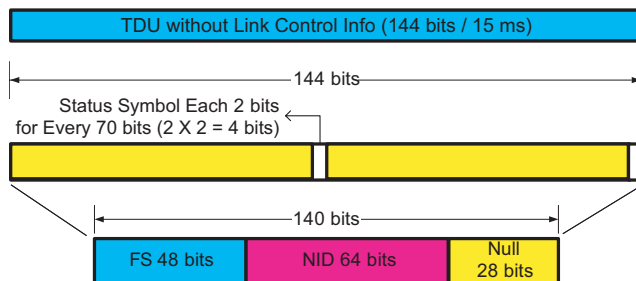

Figure 4-8: Terminator Data Unit without Link Control Info

The Terminator Data Unit can also be sent with the Link Control Word embedded in it. A diagram of the expanded Terminator Data Unit is given in Figure 4-9. The Link Control Word is the same as the Link Control Word used in LDU1, except that it is error protected with a Golay code instead of the Hamming code.

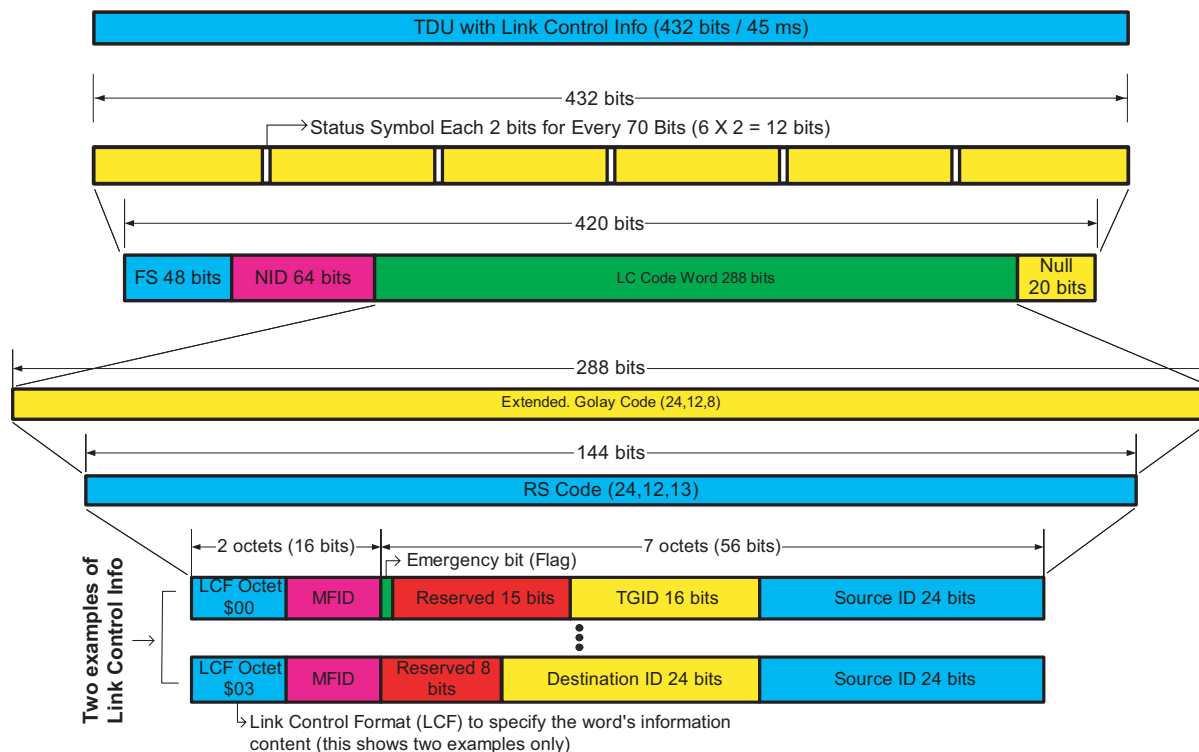

Figure 4-9: Terminator Data Unit with Link Control Info

When the voice message is finished, the transmitter continues the transmission, by encoding silence for the voice, until the Logical Link Data Unit is completed. Once the Logical Link Data Unit is completed, the transmitter then sends the Terminator Data Unit to signify the end of the message. The terminating data unit may follow either LDU1 or LDU2.

PACKET DATA UNIT

A diagram of the Packet Data Unit is given in Figure 4-10. There are two different types of delivery for data packets. Confirmed delivery is used when the recipient of the packet is required to send an acknowledgment of receipt. Unconfirmed delivery does not require an acknowledgment of receipt. Confirmed or unconfirmed delivery is defined in the header block.

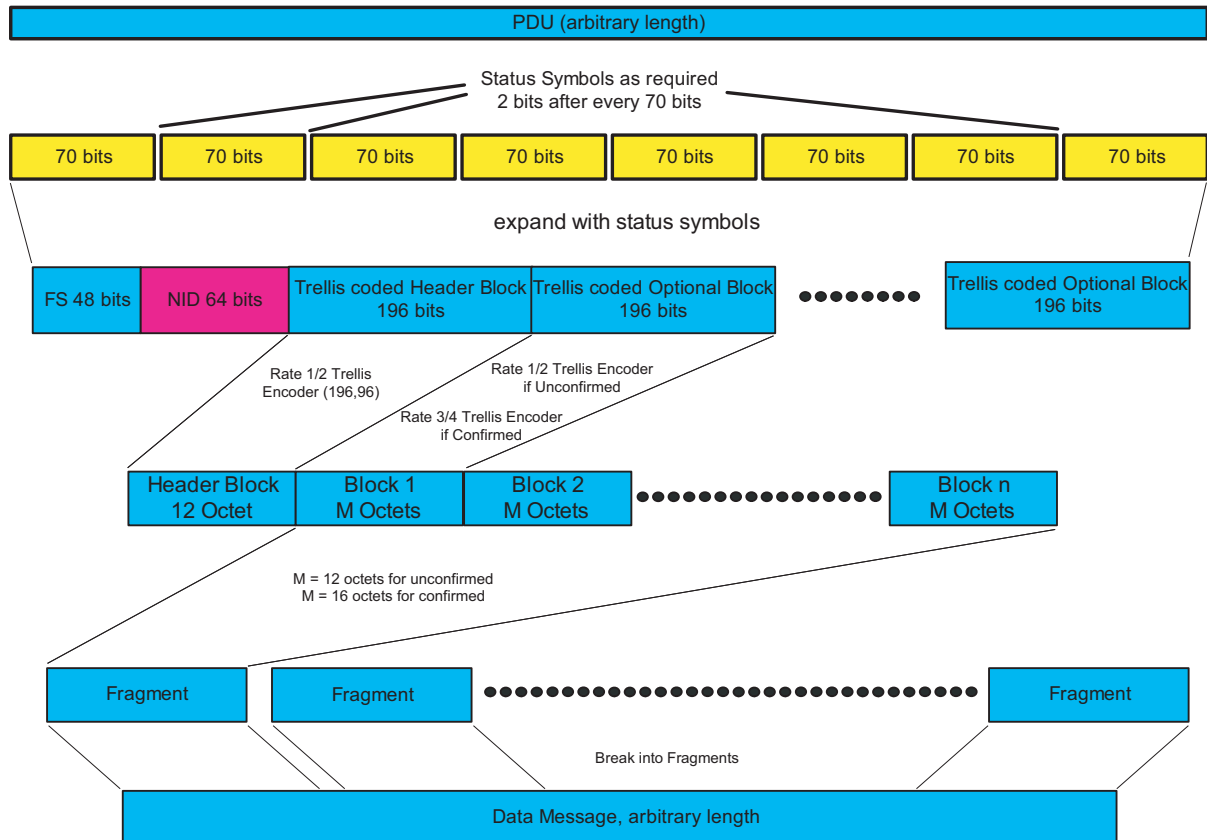

Figure 4-10: Data Packet Unit

Data is sent in variable length packets and the length of the data packet is defined in the header block. When a data packet ends, nulls are added until the next status symbol.

The data message is split into fragments, and then formed into packets, and the packets are then split into a sequence of information blocks that are error protected by a Trellis code. These blocks are then transmitted as a single data packet.

The data packets include a CRC in both the Header block and the last Data Block. The CRC verifies the accuracy of the error correction in the receiver. If the packet is corrupted in confirmed data mode during reception, then an automatic retransmission request is generated to repeat parts of the packet. The receiver then reassembles the packets into a continuous message.

A data packet may have any number of fragments. The fragments must not be longer than the storage capability of the subscriber radio. The minimum storage capacity for a fragment in the subscriber is 512 octets.

DATA HEADER AND DATA BLOCK FORMATS

Figure 4-11 shows the Header and Data Blocks for unconfirmed and confirmed data.

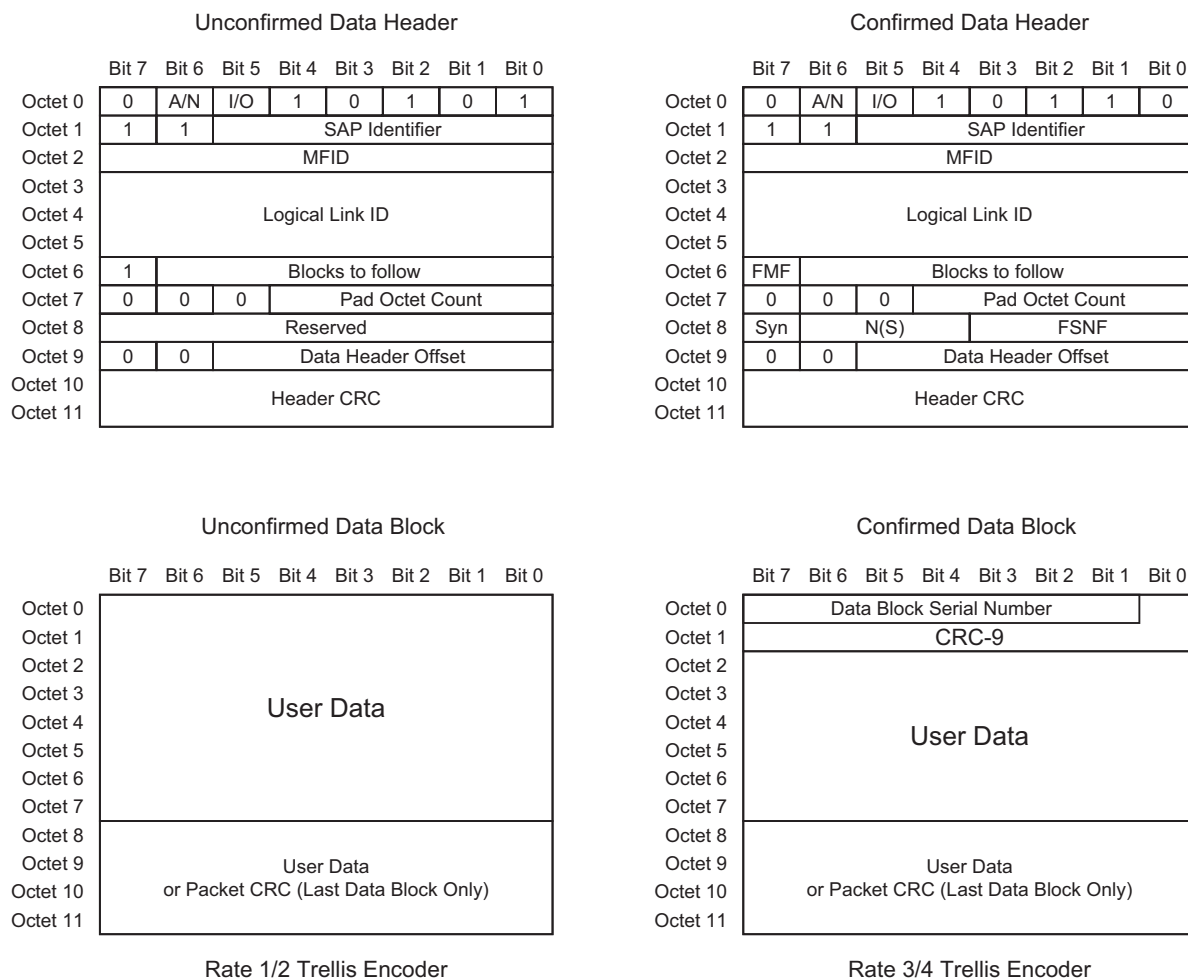

Rate 1/2 Trellis Encoder

Rate 3/4 Trellis Encoder

Figure 4-11: Unconfirmed and Confirmed Header and Data Blocks

A/N

%0 Unconfirmed Data Packet

%1 Confirmed Data Packet

I/O

%0 Inbound Message

%1 Outbound Message

Format (Bit0 to Bit4 of Octet0)

%00011	Response Packet
%10101	Unconfirmed Data Packet
%10110	Confirmed Data Packet
%10111	Alternate Multi Block Trunking Header

SAP Identifier

\$00	Unencrypted User Data
\$01	Encrypted User Data
\$02	Circuit Data
\$03	Circuit Data Control
\$04	Packet Data
\$05	Address Resolution Protocol (ARP)
\$06	SNDCP Packet Data Control
\$1F	Extended Address -- for symmetric addressing
\$20	Registration and Authorization
\$21	Channel Re-assignment
\$22	System Configuration
\$23	MR Loop-Back
\$24	MR Statistics
\$25	MR Out-of-Service
\$26	MR Paging
\$27	MR Configuration
\$28	Unencrypted Key Management message
\$29	Encrypted Key Management message
\$3D	Non-Protected Trunking Control
\$3F	Protected Trunking Control

Manufacturer's ID (MFID)

The MFID standard value of \$00 is used unless the data packet contains a nonstandard (manufacturer specific) control channel message. \$01 is reserved.

Logical Link ID

The Logical Link ID is the location that the data packet is being sent to, or received from (Source or Destination ID of the subscriber).

Full Message Flag (FMF)

%0	All subsequent retries
%1	First try for complete packet (Unconfirmed Data Packet always uses 1)

Blocks to Follow

Blocks to Follow indicates the number of blocks in the Data Packet, not including the header.

Pad Octet Count

The Pad Octet Count is the number of pad octets that have been added to the User data to form a complete block.

Syn

Syn is a flag used to re-synchronize the sequence numbers of the packet when asserted, for specially defined registration messages. Syn is used for Confirmed Data Packets only.

N(S)

N(S) is the sequence number of the packet used to identify each request packet so that the receiver may correctly order the received message segments and eliminate duplicate copies. N(S) is used for Confirmed Data Packets only.

FSNF

The Fragment Sequence Number Field is used to consecutively number message fragments that make up a longer data message. FSNF is used for Confirmed Data Packets only.

Data Header Offset

The Data Header Offset is used to divide the Data Block into a data header and data information. A Data Header Offset is only used in some applications.

Header CRC

The Header CRC is the CRC parity check for the Header Block

Data Block Serial Number

The Data Block Serial Number is an incremental serial number for each Data Block.

CRC-9

CRC-9 is the 9 bit CRC parity check for the Data Block.

Packet CRC

The packet CRC is the 4-octet CRC parity check coded over all of the User Data blocks (including the User Data in the last block).

OTHER DATA FORMATS

Response Packet Format

The Response Packet is used to acknowledge (or not acknowledge) delivery for Confirmed Data Packets. The response packet contains fields called Class, Type and Status to specify the meaning of the response.

Enhanced Addressing Format

Enhanced Addressing is used to send data directly between subscribers. A Source and Destination address are both required on every packet. The SAP Identifier is used to signify that a second address is inserted in the packet before the user data.

Trunking Signaling Block (TSBK)

The Trunking Signaling Block (TSBK) is a special abbreviated data packet used for trunking control channel messages. More detailed information on the TSBK can be found in Chapter 6: P25 Trunking.



CHAPTER 5: CONVENTIONAL FIXED STATION INTERFACE

INTRODUCTION

The Conventional Fixed Station Interface (CFSI) is the interface between a conventional fixed station (base station), and either the RF Subsystem (RFSS) or a Console Subsystem. The RFSS and/or Console Subsystem are referred to as the host. The fixed station is connected to a host via either an Analog Fixed Station Interface (AFSI) or a Digital Fixed Station Interface (DFSI). A host can support multiple analog and digital fixed station interfaces. The Console Subsystem is comprised of any type of console from the telephone-type to software based computer consoles.

Currently, the CFSI is used for voice messages only. The data transfer capability is under development.

Figure 5-1 shows a P25 radio system with Conventional Fixed Station Interface. The fixed stations can be analog only, digital only or mixed mode stations. Regardless of the RF mode of operation, the fixed stations can use either the DFSI or AFSI. A digital only or mixed mode fixed station will have some limitations in transporting digital information (NAC, TGID, Emergency, etc.) back to the host over an AFSI.

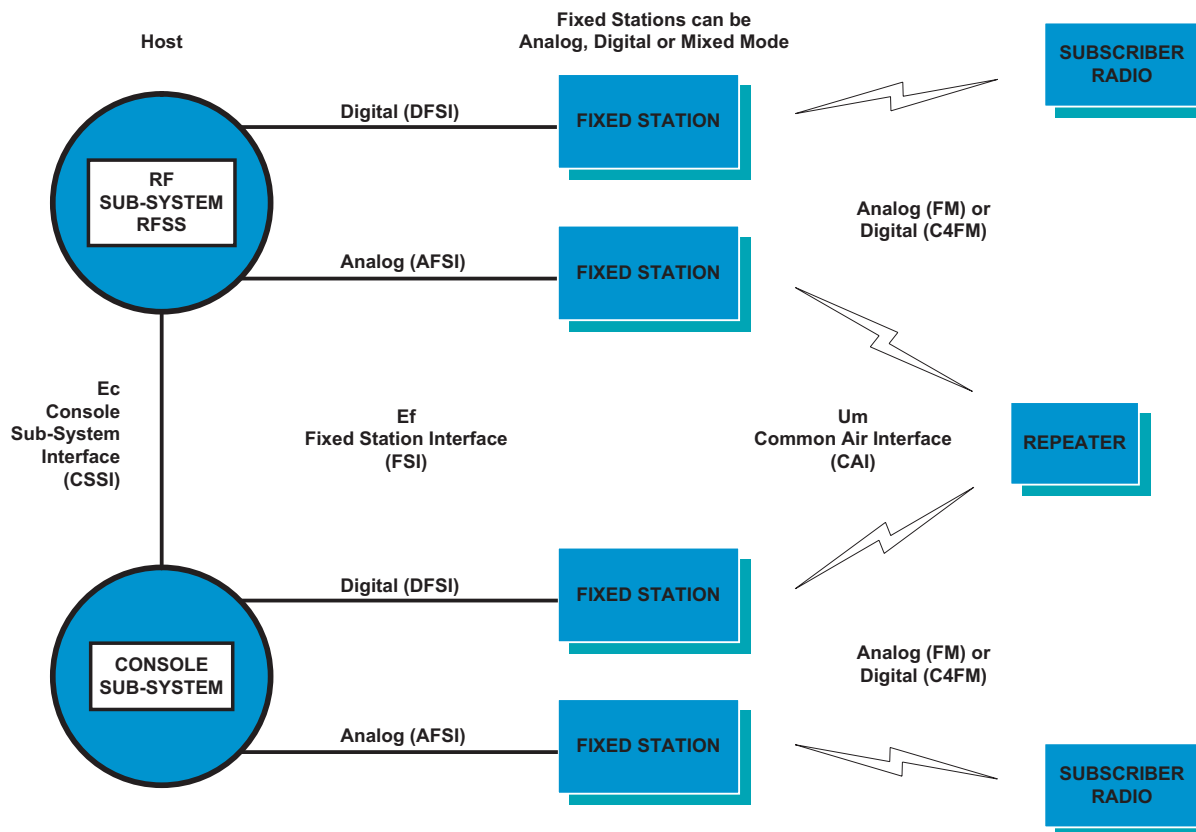

Figure 5-1: Conventional Fixed Station Interface Overview

The AFSI and DFSI both support:

- 1) An intercom capability between the fixed station and the host without RF transmission.
- 2) Two different repeat modes. The fixed station can repeat the incoming signal directly from the receiver to the transmitter, or if the audio connection from the fixed station to the host is full duplex, the host may repeat the incoming audio back to the fixed station for transmission. If the fixed station repeats the signal, any transmission from the host would override the repeat transmission (except in an AFSI 2 wire simplex tone remote interface).

ANALOG FIXED STATION INTERFACE

The analog fixed station interface is defined as a single fixed station connected via a 2 or 4 wire analog audio interface (full-duplex, half-duplex or simplex) to a single host (console or RFSS). Control signals are transferred by one of two options:

- 1.) E&M control signaling between the fixed station and the host for COR and PTT signaling.
- 2) Tone Remote Control signaling from the host to the fixed station allowing a variety of control functions including transmitter keying, transmitter channel control, receiver squelch control, receiver monitor control, clear/secure controls, analog/digital mode controls, etc.

Figure 5-2 shows the conventional Analog Fixed Station Interface (AFSI).

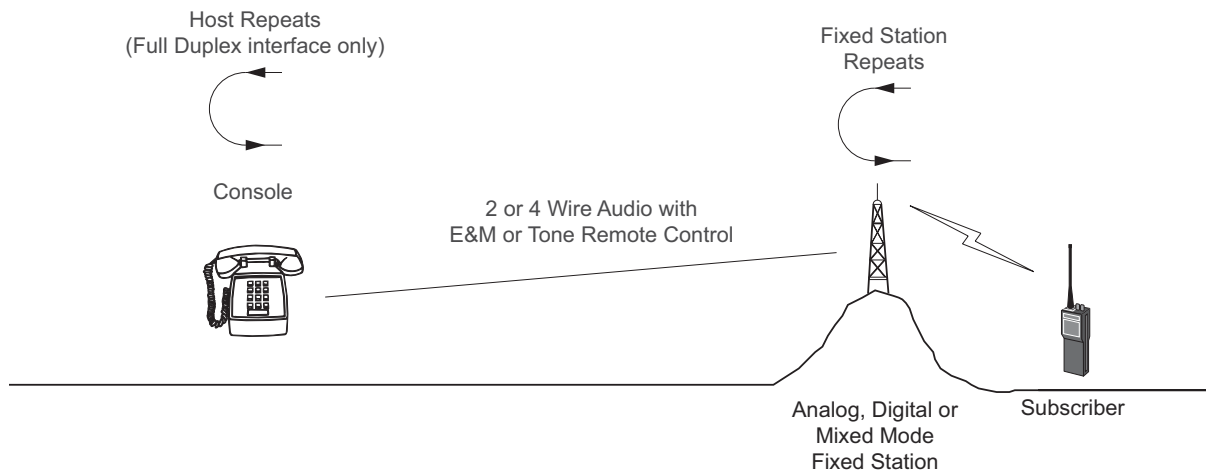

Figure 5-2: Analog Fixed Station Interface

E&M Specifications

Fixed Station audio input range: -30 dBm to +10 dBm (maximum modulation in analog or P25 digital mode).

Fixed Station audio output range: -30 dBm to the maximum limit permitted by leased circuit compliance (maximum modulation in analog mode).

The E-pair expects the host end to provide a dry contact closure for fixed station transmission. The M-pair provides a dry contact closure for fixed station reception. The E & M pairs work over a range of 5 to 150 mA current with 50 ohm maximum contact resistance while the contacts are closed, and 10 to 60 Vdc with 5 megohm minimum resistance while the contacts are open. The E-pair limits its current to this range.

Tone Remote Control Specifications

Figure 5-3 shows the Tone Remote Control sequence the host will send to control the Fixed Station. The sequence begins with 120 ms of High Level Guard Tone (HLGT) at -30 to +10 dBm, followed by 40 ms of Function Tone, -10 dB relative to the HLGT, followed by the Low Level Guard Tone (LLGT) -30 dB relative to the HLGT. The LLGT is summed with the audio (average level of -6 to -18 dB relative to the HLGT) for the duration of the transmission. All of these in-band tones are filtered out before being transmitted. The Guard Tone will be 2100 Hz, 2325 Hz or the default tone 2175 Hz.

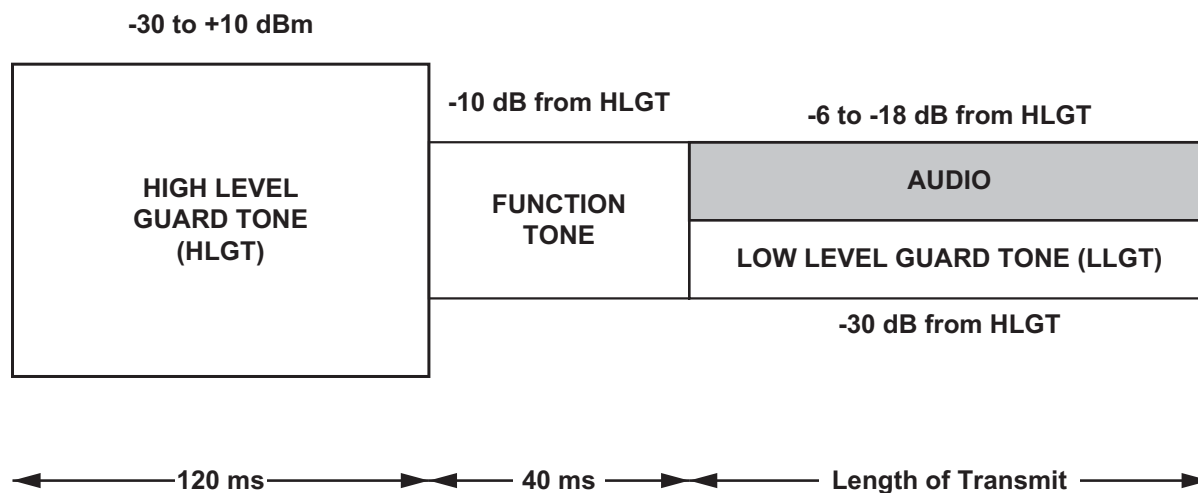

Figure 5-3: Tone Remote Control Sequence

Function Tones used for additional control of the fixed station are shown in Table 5-1:

Tone	Function	Secondary Function
2050 Hz	Monitor Receiver	
1950 Hz	Transmit Channel 1	
1850 Hz	Transmit Channel 2	
1350 Hz	Transmit Channel 3	Select Digital mode
1250 Hz	Transmit Channel 4	Select Analog mode
1150 Hz	Transmit Channel 5	Select Secure mode
1050 Hz	Transmit Channel 6	Select Clear mode
1750 Hz	Transmit Channel 7	Second receiver off
1650 Hz	Transmit Channel 8	Second receiver on
1550 Hz		Repeater mode off
1450 Hz		Repeater mode on

Table 5-1: Tone Remote Control Function Tones

Although secondary functions can be used to select Analog / Digital and Secure / Clear modes, these modes can be pre-programmed in the fixed station on a per channel basis.

DIGITAL FIXED STATION INTERFACE

The digital fixed station interface uses Internet protocols to connect between a fixed station and a host. The DFSI has a Control Service and a Voice Conveyance Service. The Control Service is a point-to-point connection between the host and a fixed station. The Voice Conveyance service can be a point to multi-point connection (host to fixed stations).

Figure 5-4 shows the conventional Digital Fixed Station Interface (DFSI).

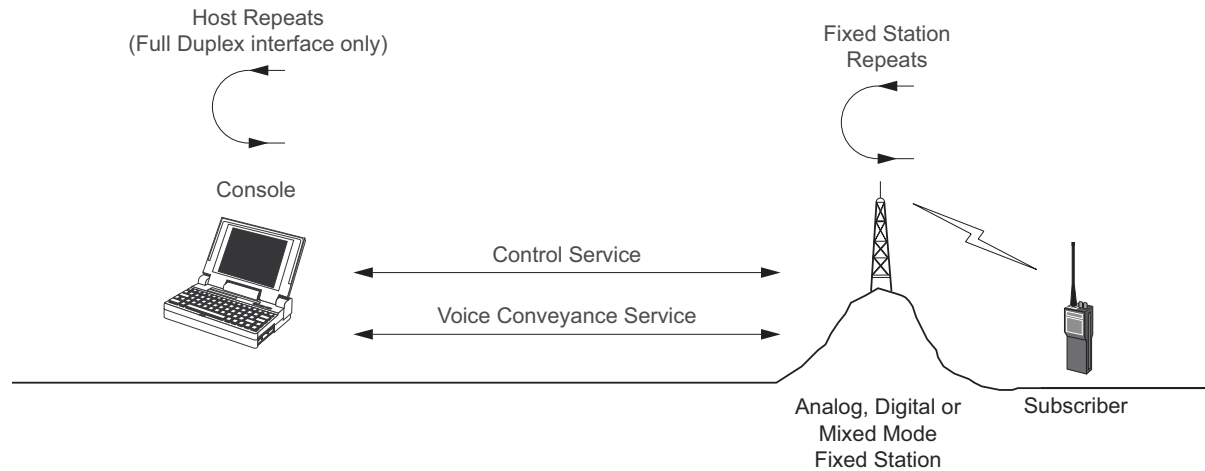

Figure 5-4: Digital Fixed Station Interface

Internet Protocol

The Internet Architecture Layers are used to construct the Digital Fixed Station Interface (DFSI) protocol suite as shown in Figure 5-5.

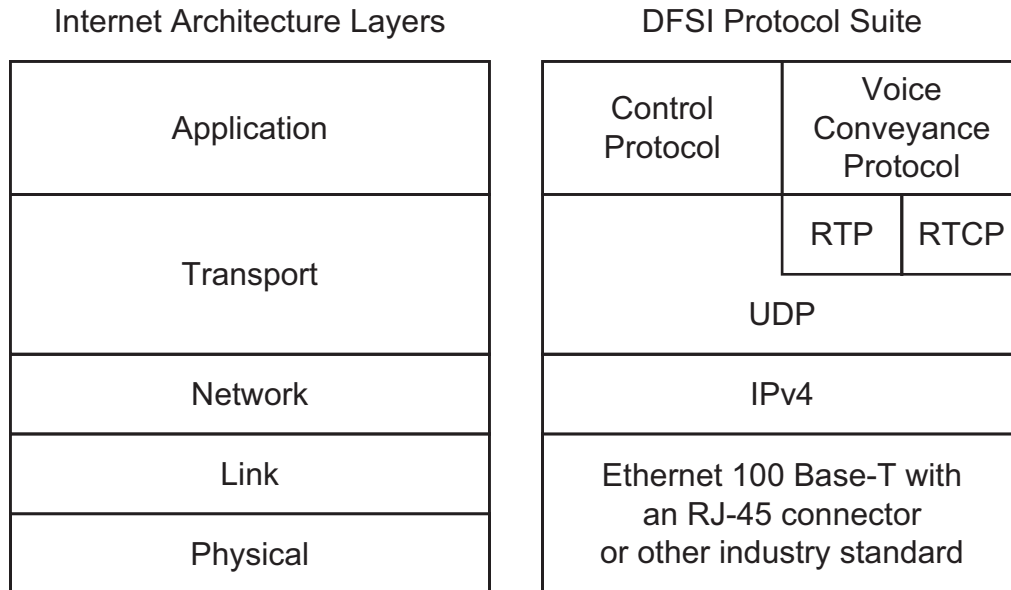

Figure 5-5: DFSI Internet Protocol Suite

Physical and Data Link Layers

The DFSI uses Ethernet 100 Base-T with a RJ45 connector as the physical and data link layers. In addition to the Ethernet 100 Base-T, manufacturers may offer other industry standard physical and data link layer protocols that support the internet protocol.

Network Layer

The DFSI uses the Internet Protocol (IP), a connectionless packet protocol. The Internet Protocol uses unicast IP addresses to send information to a particular destination, and multicast IP addresses to send information to a number of hosts. Host and fixed station equipment support unicast IP addresses, and hosts are also able to send to IP multicast addresses. The DFSI currently uses IPv4, while IPv6 is for possible future use.

Transport Layer

The DFSI uses the User Datagram Protocol (UDP) for its multicast capability and its ability to suite real time applications. The Control Service transports information over UDP, and the Voice Conveyance Service transports information over Real-time Transport Protocol (RTP) on UDP for more reliable transport. Real-time Transport Control Protocol (RTCP) may be used as well, but is not required.

Control Service

The Control Service provides control capabilities similar to the control capabilities of the analog fixed station interface. The Control Service also establishes and maintains the connection between the host and fixed station.

There are ten control messages defined for the DFSI as shown in Table 5-2.

Message Name	Description
FSC_CONNECT	Sent by the host only to establish a connection with the fixed station.
FSC_HEARTBEAT	Sent periodically by both the fixed station and the host to establish and maintain heartbeat connectivity.
FSC_ACK	Sent by both the host and the fixed station to acknowledge (or not acknowledge) the receipt of a control message.
FSC_SBC	Sent by both the host and the fixed station to convey Single Block Control messages such as Emergency Alarm and Telephone Interconnect Dialing.
FSC_MAN_EXT	Sent by the host and the fixed station to convey manufacturer specific value added control messages.
FSC_SEL_CHAN	Sent by the host to select the fixed station receive and transmit channels.
FSC_SEL_RPT	Sent by the host to select repeat or non-repeat mode of the fixed station.
FSC_SEL_SQUELCH	Sent by the host to select the squelch mode (monitor) of the fixed station.
FSC_REPORT_SEL	Sent by the host to cause the fixed station to report selected modes (repeat, squelch, channel select) back to the host.
FSC_DISCONNECT	Sent by the host to disconnect from the fixed station.

Table 5-2: Control Service Messages

Voice Conveyance Service

The Voice Conveyance Service passes RTP payloads between the host and the fixed station. The Voice Conveyance Service will transport information to and from both an analog and a digital fixed station. The RTP payload for a digital transmission carries the entire Common Air Interface voice frames including voice encoded with IMBE (and potentially encrypted), Link Control Word, Encryption Synch Word, and Low Speed Data. The RTP payload for an analog transmission carries μ law PCM audio, that includes all voice information and possibly in-band signaling.

The Voice Conveyance Service transports full-duplex clear (non-encrypted) or secure (encrypted) audio, PTT and COR signaling (by way of start of stream information), voter identification and CAI information such as Unit ID (or Console ID), TGID, NAC, and Emergency bit between the fixed station and its host.

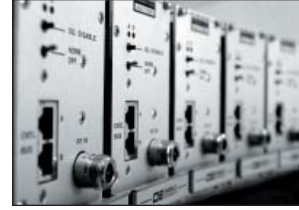

CHAPTER 6: P25 TRUNKING

INTRODUCTION TO P25 TRUNKING

In a conventional radio system, the operation of the system is controlled by the radio users, whereas in a trunked system the management of system operation, including call routing and channel allocation, is automatic. A trunking system is basically a group of communications channels automatically sharing among a large group of users. The users request access to the communication channels (also called traffic channels), and a trunking controller (also referred to as FNE – Fixed Network Equipment) grants access to the traffic channels. In a conventional system (non-trunked), the users control their own access to the traffic channels by direct selection of frequencies or channels.

P25 trunking standards specify a control channel, and one or more traffic channels. The control channel can be a dedicated control channel, or optionally, a composite control channel. A dedicated control channel will operate as a control channel only, where a composite control channel can operate as a control channel or as a traffic channel when all other traffic channels are busy. A secondary control channel can also be specified, to be used when the primary control channel is unavailable.

The P25 trunking standards and P25 digital conventional standards use identical modulation (C4FM), bit rate (9600 bps), voice messages (CAI), and control messages (data packets) for various features, including voice, data, status, message, or other features. The Common Air Interface for both trunking and conventional P25 digital systems is similar. The only difference is that the trunked version requires a command/response process to a trunking controller (on a control channel) using packet access techniques which coordinates the users' access.

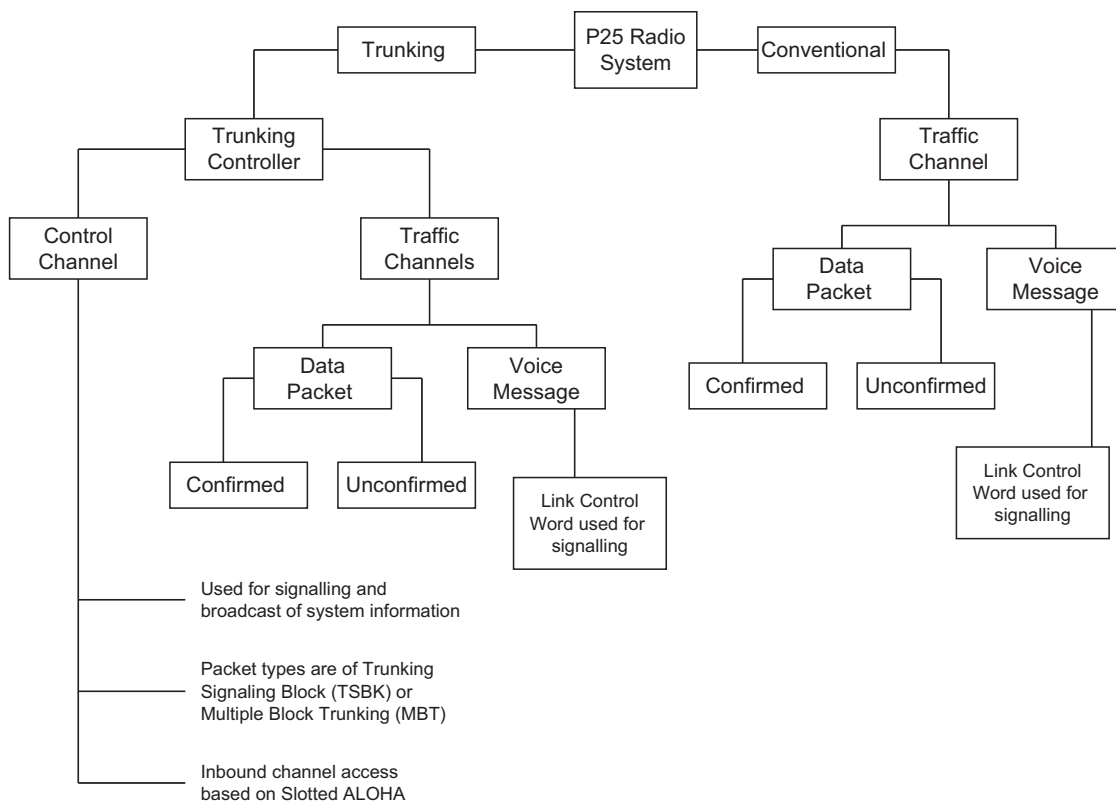

Figure 6-1: P25 Trunking and Conventional System Overview

IMPLICIT / EXPLICIT

A P25 trunked system can be configured in either the implicit mode or the explicit mode of operation. In the implicit mode of operation, all radios are pre-programmed with the channel and frequency information. The radio then looks internally to the pre-programmed channels when switching between control and traffic channels. The explicit mode sends the channel and transmit or receive frequency over the air to the radio. The implicit mode of operation typically uses single block messages, where the explicit mode typically uses multi block messages.

REGISTRATION

The subscriber unit (mobile or portable radio unit) registers with the network whenever the subscriber is turned on or moves into a new zone. Registration ensures that only authorized users access the network, and that the network can track where the subscriber is located.

There are two types of registration in a P25 trunked network, a full registration and a location registration. A full registration will check the validity of the subscriber and will occur when the subscriber is first switched on, enters a new registration area, the user selects a new network or when the RFSS requests registration. A location registration occurs when the subscriber has moved to another site within the coverage area.

Figure 6-2 below shows an example of a P25 trunked system infrastructure configuration. The registration area is defined as a System and the Location Registration Area may be defined as one or more sites within the RFSS.

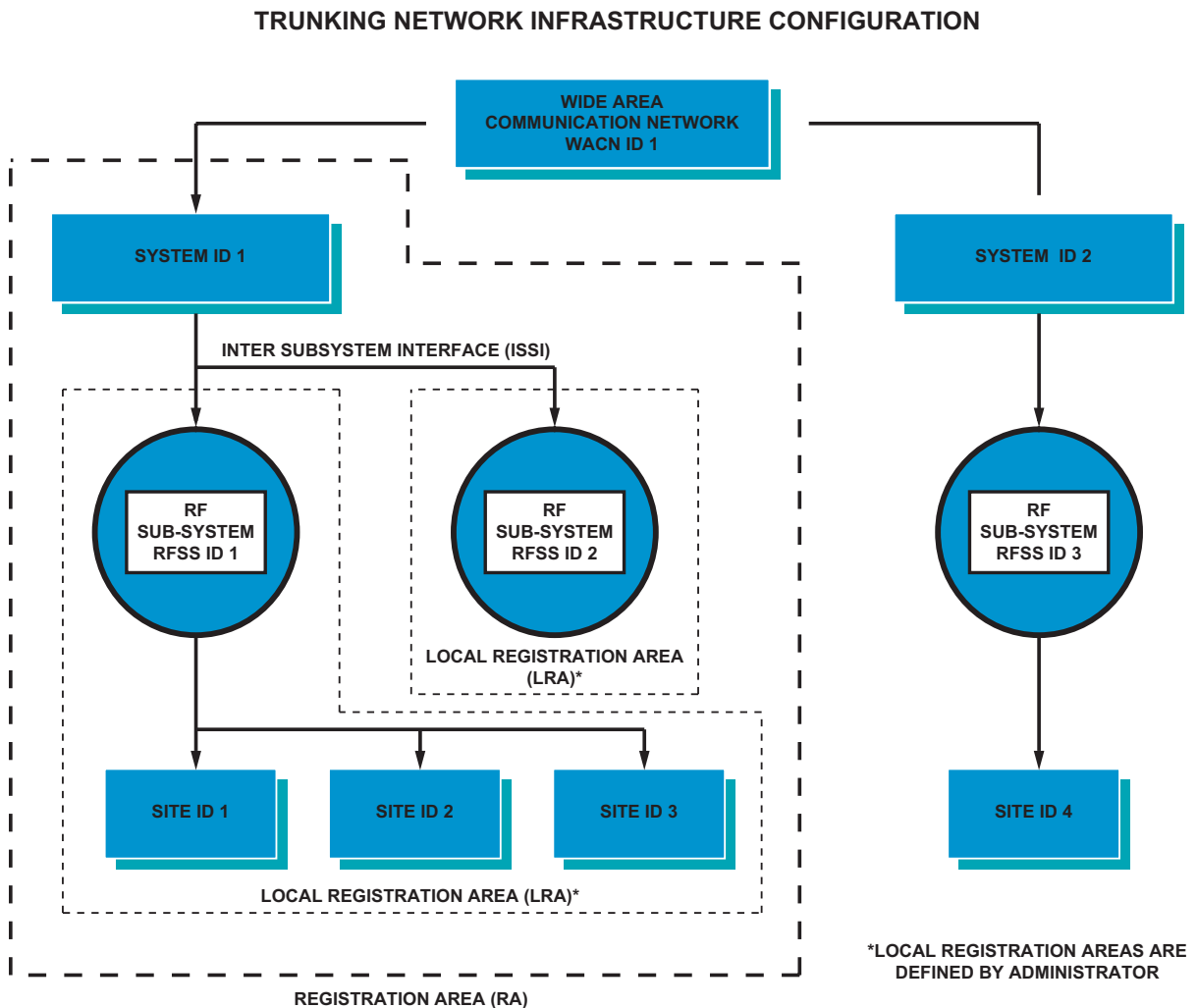

Figure 6-2: P25 Trunking System Infrastructure

ADDRESSING

Each component of the trunking system infrastructure is uniquely addressable by the following identifiers:

Wide Area Communication Network ID (WACNID) – 20 bits

\$00000	reserved
\$00001 to \$FFFFE	WACN IDs
\$FFFFFF	reserved

System ID – 12 bits

\$000	reserved
\$001 to \$FFE	System IDs
\$FFF	reserved

RFSS ID – 8 bits

\$00	reserved
\$01 to \$FE	RFSS IDs
\$FF	reserved

Site ID – 8 bits

\$00	reserved
\$01 to \$FE	Site IDs
\$FF	reserved

Each subscriber unit in a trunking system is uniquely addressable by the following identifiers:

Working Unit ID – 24 bits

\$000000	no-one. This value is never assigned to a radio unit
\$000001 to \$FFFFFFC	for general use
\$FFFFFFD	system default
\$FFFFFFE	registration default. WUID to be used during registration when no viable unit ID is available (eg. ESN registration request).
\$FFFFFFF	designates everyone

Working Group ID – 16 bits

\$0000	no-one
\$0001 to \$FFFE	assignable working group
\$FFFF	working group that includes everyone. Used for an All Call

During Registration, the trunking controller assigns each Subscriber a Working Unit ID (WUID) and Working Group ID (WGID). The WUID and WGID are temporary ID's assigned to the subscriber while in that Registration Area. The trunking controller maintains a database to track the assignment of WUID and WGID to the subscribers Unit ID and Talk-group ID (TGID), also referred to as the Subscriber Group ID (SGID).

CONTROL CHANNEL MESSAGES

The control channel packet structure is based on the data packet structure of the Common Air Interface. The trunking control channel consists of both an inbound and an outbound path. A control channel packet sent from the subscriber unit to the trunking controller is called an Inbound Signaling Packet (ISP) and a control channel packet sent from the trunking controller to the subscriber unit is called an Outbound Signaling Packet (OSP). These messages are typically formatted as a single block message called a Trunking Signaling Block (TSBK). The TSBK uses the same Trellis coding as an unconfirmed data packet. A Multiple Block Trunking (MBT) packet structure is only used when there is more information than normally sent by TSBK and uses the unconfirmed data packet structure.

INBOUND SIGNALING PACKET ACCESS VIA SLOTTED ALOHA

Subscribers access the inbound control channels to send ISP's using a technique called Slotted ALOHA. Slot boundaries are set by the status symbols in the outbound control channels OSP's. The first status symbol of every OSP is 11 allowing the subscriber to synchronize ISP transmissions accordingly. The status symbols occur every 7.5 ms, which is called a microslot. An ISP lasts for 32.92 ms, so the slot needs to exceed this in order to allow for the ISP. The slot boundaries need to be a multiple of a microslot making the minimum required slot 37.5 ms (5 microslots). The trunking system may utilize slot times greater than the minimum to accommodate slower subscribers. OSP and ISP Status Symbols are shown in Table 6-1.

OSP Status Symbols

Symbol	Status of Inbound Channel	Description
%00	Unknown	Not Used
%01	Busy	Inbound control channel is not available
%10	Unknown	Used between slot boundaries
%11	Idle	Used to indicate the start of Inbound slot

ISP Status Symbols

Symbol	Status of Inbound Channel	Description
%00	Unknown	Not Used
%01	Busy	Not Used
%10	Unknown	Used for all ISPs
%11	Idle	Not Used

Table 6-1: OSP and ISP Status Symbols

TRUNKING SYSTEM OPERATION

In order to understand how a P25 trunking system operates, it is important to understand the basic sequence of events that occur in a P25 trunking system. Figure 6-3 shows the basics of a P25 trunking system operation.

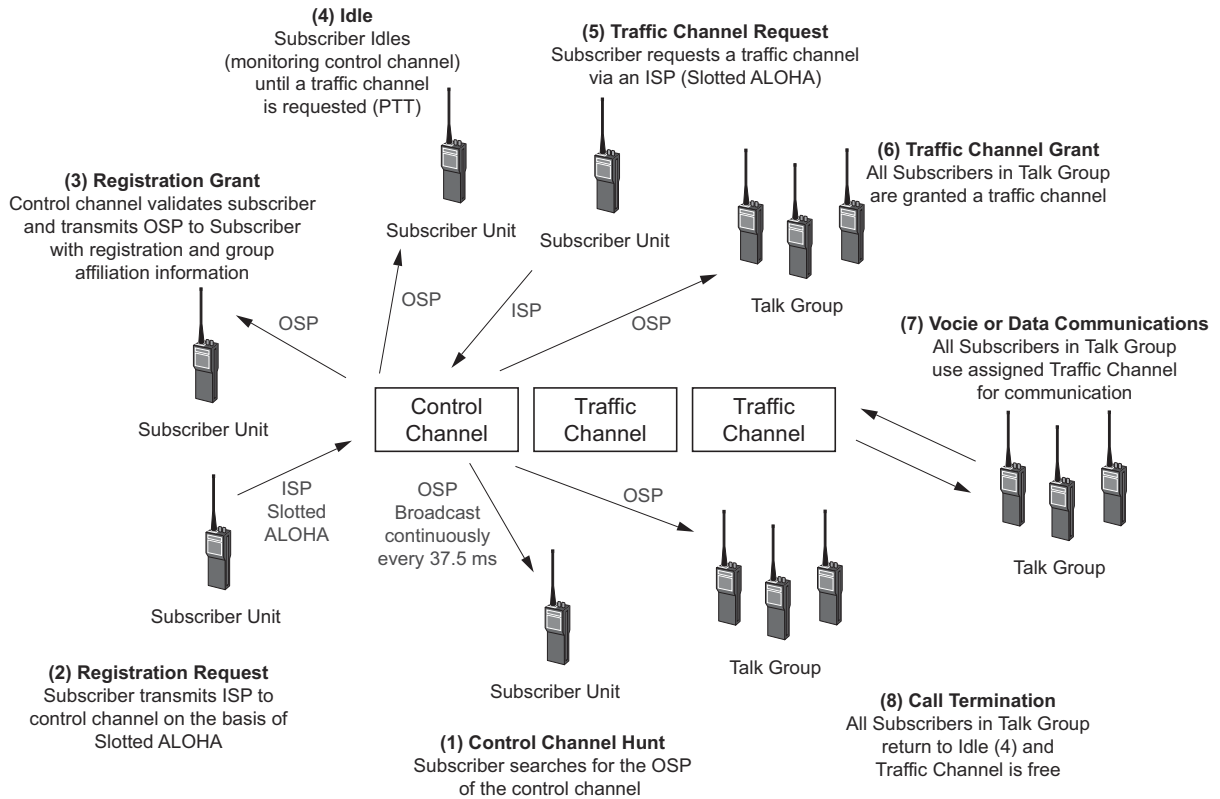

Figure 6-3: P25 Trunking System Operation

-
- (1) Control Channel Hunt – the subscriber unit will hunt for the control channel by scanning its list of pre-programmed channels for the OSPs that are continually broadcast from the trunking controller.

 - (2) Registration Request – the subscriber will register with the trunking controller (RFSS). The trunking controller can restrict access to only valid subscriber units and can record where that subscriber is located within the network. Full registration or Location Registration can occur here.

 - (3) Registration Grant – the trunking controller will grant access to the subscriber and will assign a Working Unit ID (WUID) and Working Group ID (WGID) to the subscriber.

 - (4) Idle – the subscriber will monitor the control channel until the subscriber requests a traffic channel or is assigned a traffic channel based on another subscriber in the talk group requesting a traffic channel for that group.

 - (5) Traffic Channel Request – the subscriber requests a traffic channel for voice or data communications.

 - (6) Traffic Channel Grant – the trunking controller grants a traffic channel to the subscriber and notifies the recipients of the voice or data message with a traffic channel grant (typically a talk group).

 - (7) Voice or Data Communications – All subscribers in the Talk Group access the traffic channel and communicate voice or data message.

 - (8) Call Termination – All subscribers in the talk group return to Idle (4) and monitor the control channel.
-

TRAFFIC CHANNEL OWNERSHIP

The traffic channel can be assigned to a talk group in two different ways.

Transmission Trunking assigns the traffic channel for the duration of that transmission. Once the transmission is over, the call is terminated. A new traffic channel is assigned for the next transmission. A conversation with multiple transmissions will require a new traffic channel for each transmission.

Message Trunking assigns the traffic channel to a talk group for the entire conversation. The conversation is deemed to be finished when the delay between transmissions exceeds a preset time. The trunking controller may terminate a conversation if the traffic channel is required for a higher priority use.

ENCRYPTION

The traffic channels of a trunked system can be encrypted in the same manner as a conventional system encrypted system, using the Algorithm ID, Key ID and Message Indicator for encryption variables.

The control channel of a trunked system may also be optionally encrypted. In a TSBK message, the Opcode and Arguments may be encrypted and the Protected trunking block flag (P) is set to indicate encryption. In an MBT message, the Logical Link ID, (and in the alternate header format, the Opcode and Octets 8 and 9) as well as all Data (except the CRC) may be encrypted, and the SAP Identifier is set to indicate encryption.

The Algorithm ID, Key ID and initial Message Indicator (which is incremented each microslot) may be set by sending control channel information in the form of a Protection Parameter Update using standard trunking control channel formatted information.

DATA PACKET STRUCTURES FOR SINGLE AND MULTI BLOCK MESSAGES

The control channel message is composed of one or more information blocks protected by a rate 1/2 trellis code, and the sequence of blocks is transferred over the common air interface as a single data packet. The last part of the data packet is a CRC to be used to verify the accuracy of the error correction at the received end

The structure for conventional data packets is the same structure used for ISP and OSP control channel packets. The Frame Synchronization (FS) and Network Identifier (NID) are sent before the information block(s) for the packet. There is one Status Symbol (SS) consisting of two(2) bits inserted after every 70 bits in a packet.

The 4-bit Data Unit ID portion of the 16-bit Network Identifier(NID) indicates the format of the control channel packet as either:

\$7 Indicating the single block format (TSBK)

\$C indicating the multiple block format (PDU)

A special abbreviated data packet, the Trunking Signaling Block (TSBK) is used for control channel messages that are time sensitive (requests and grants for traffic channels) and is the typical data packet used. The ISP is limited to one TSBK where the number of TSBKs in the OSP is variable (single, double or triple block) and determined by the trunking controller to maximize the control channel resource. Figure 6-4 shows the Trunking Signaling Block structure and Figure 6-5 shows the contents of the TSBK.

Control channel messages that are not time sensitive, and that contain more information than a TSBK can handle, such as registration, can be sent as a Multiple Block Trunking (MBT) message. MBT uses the unconfirmed data packet format with the packet split into blocks of 12 octets. The first block is a header block, with up to 3 data blocks following. Figure 6-6 shows the Multiple Block Trunking structure (unconfirmed data packet) and Figure 6-7 shows the contents of the two MBT formats.

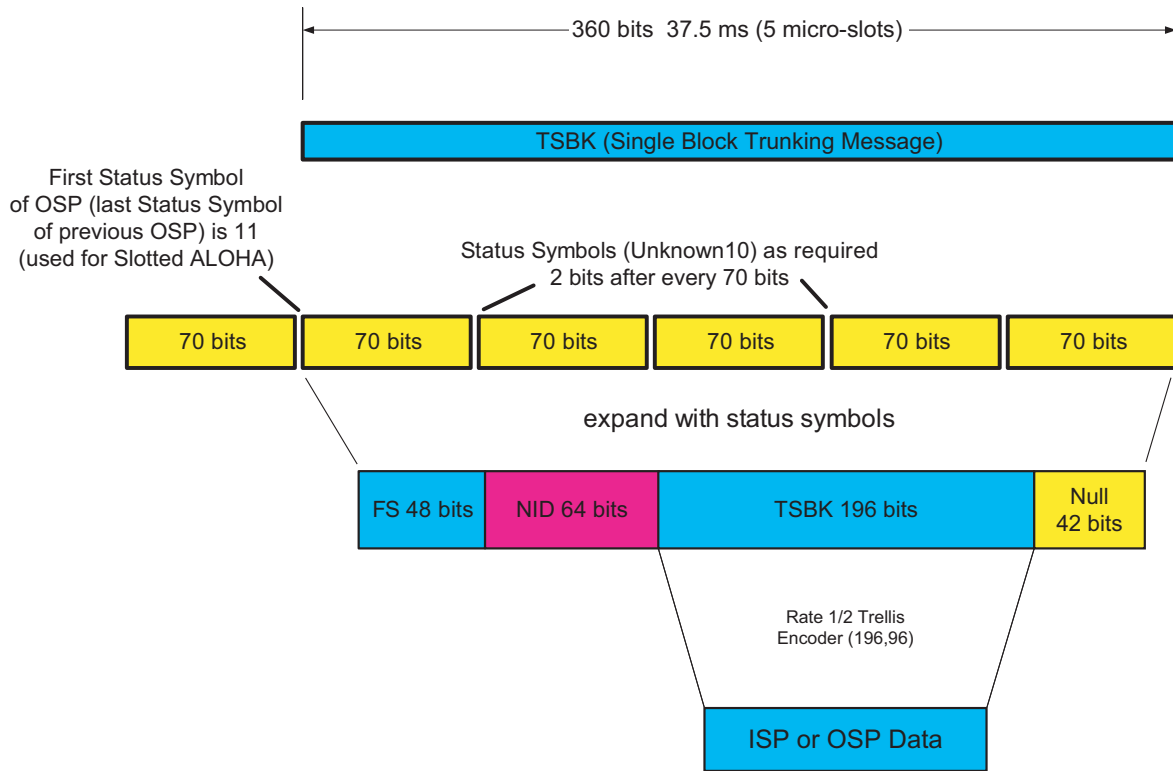

Figure 6-4: Trunking Signaling Block Structure

Trunking Signal Block (TSBK)

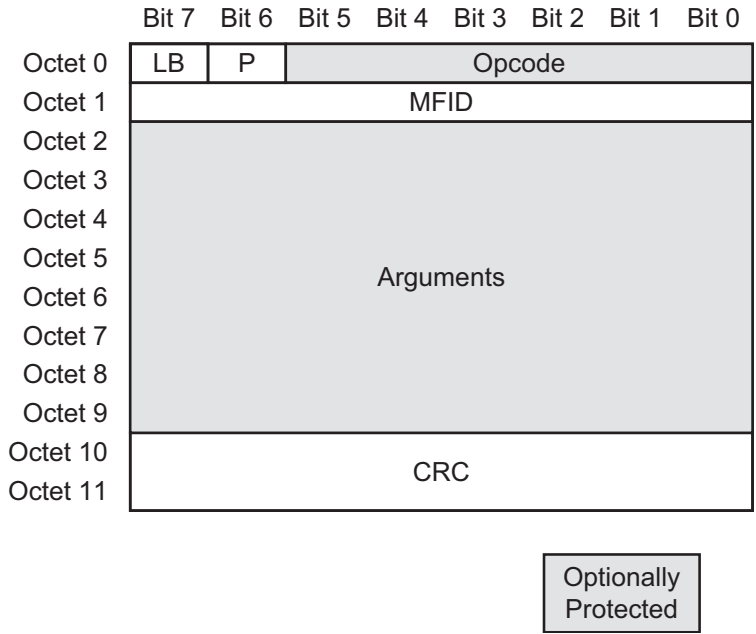

Figure 6-5: Trunking Signaling Block (TSBK)

The Trunking Signaling block contains 10 octets of address and control information, followed by 2 octets of CRC.

Following is the general description of the fields of this TSBK:

Last Block flag (LB)

%0	more TSBKs to follow in this packet
----	-------------------------------------

%1	this is the last TSBK in the packet
----	-------------------------------------

Protected trunking block flag (P)

%0	non-protected packet mode
----	---------------------------

%1	protected packet mode
----	-----------------------

Opcode

The Opcode defines the specific type of message the TSBK contains in the Arguments field (eg. Group call, unit to unit call, status message, registration, etc.).

Manufacturer's ID (MFID)

The MFID standard value of \$00 is used unless the TSBK contains a nonstandard (manufacturer specific) control channel message. \$01 is reserved.

Arguments

The Arguments contains the information of the TSBK. The specific type of information is defined by the Opcode.

CRC

The CRC is the CRC parity check for the TSBK.

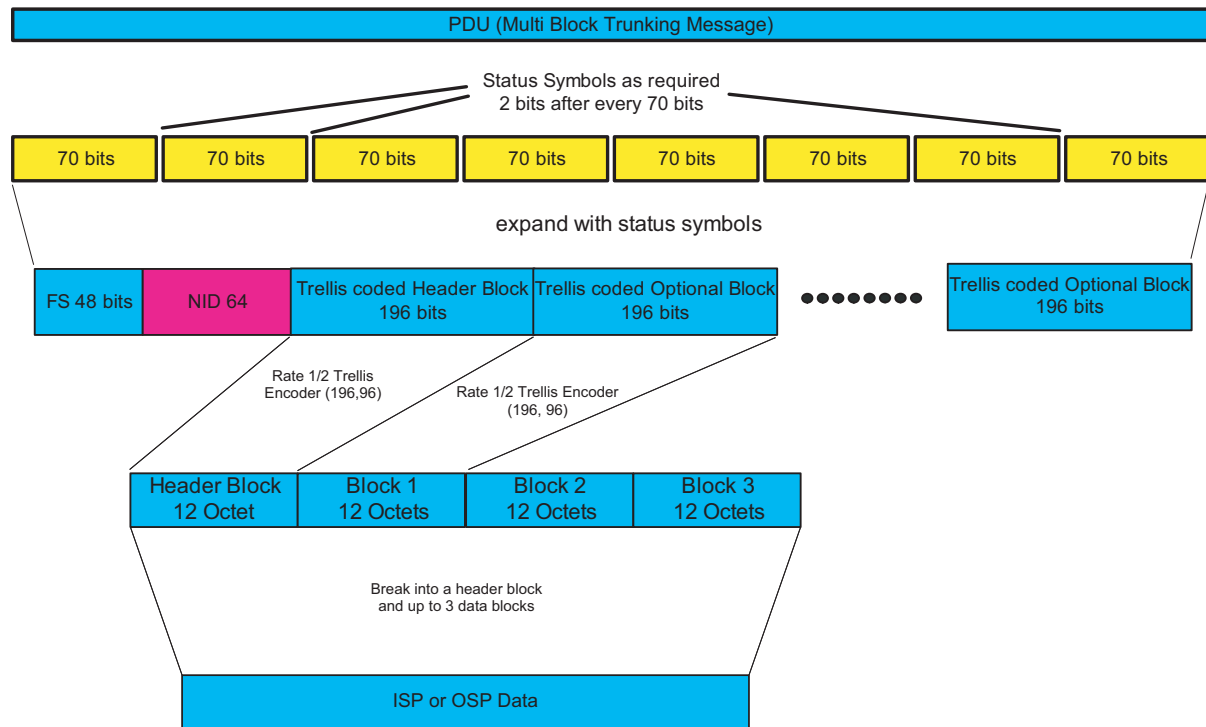

Figure 6-6: Multiple Block Trunking Structure (Unconfirmed PDU)

Multi-Block Trunking Packet

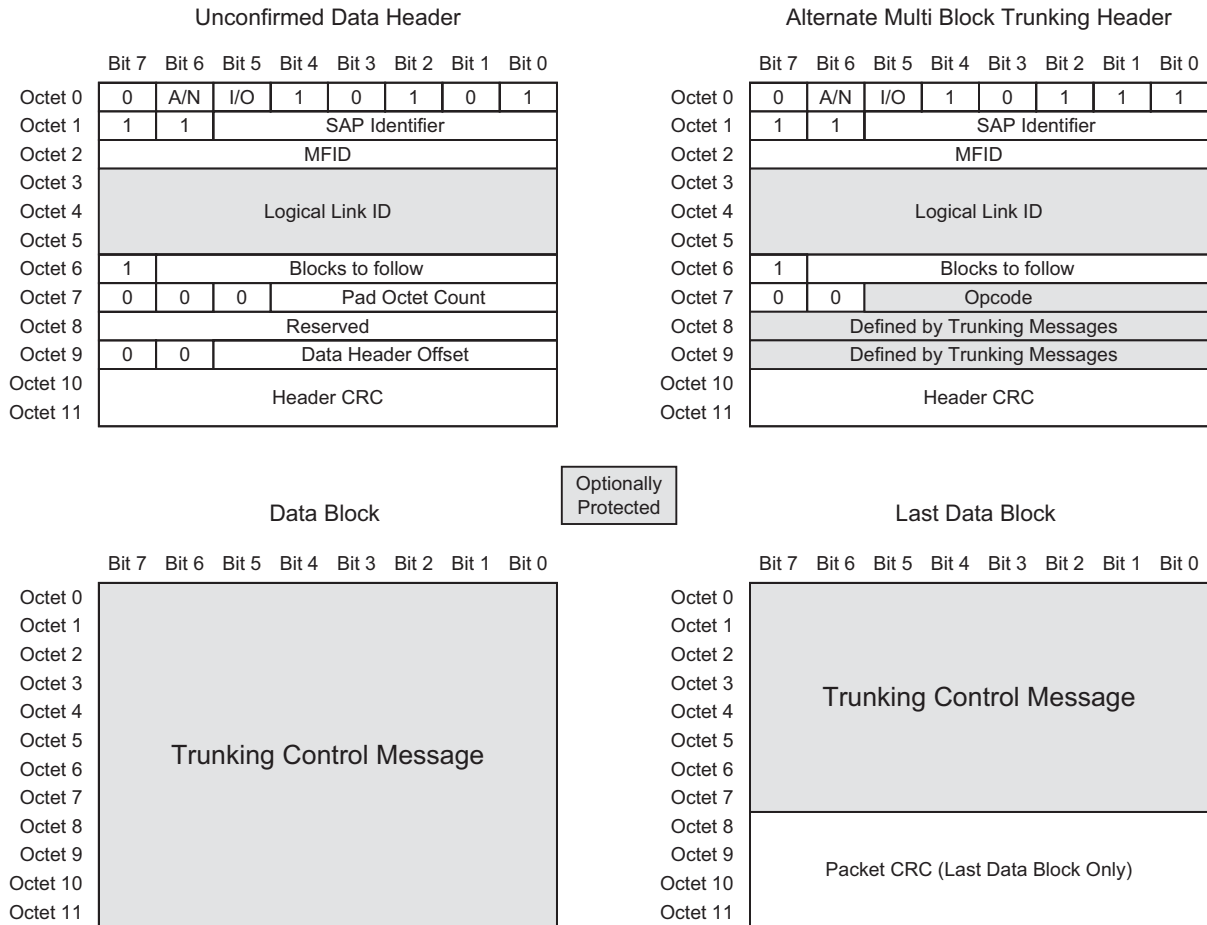

Figure 6-7: Multiple Block Trunking (MBT)



CHAPTER 7: IMBE™ AND AMBE+2™ VOCODERS

P25 radios use the Improved Multi-Band Excitation (IMBE™) vocoder, developed by Digital Voice Systems, Inc. (DVSI), to convert analog speech into a digital bit stream suitable for transmission over the P25 Common Air Interface (CAI). At the transmitter, the vocoder consists of an encoder that converts the analog voice signal from a microphone into a digital bit stream, while at the receiver, the vocoder consists of the decoder that converts the digital bit stream back into analog voice suitable for playback through a speaker.

In P25, analog voice is converted into a digital bit stream with a net bit rate of 4.4 kbps for voice information and a gross bit rate of 7.2 kbps after error control coding (note: after vocoding, 2.4 kbps of signaling information is added to make 9.6 kbps total). The vocoder uses a frame size of 20 ms.

P25 selected the IMBE™ vocoder in 1992 after a competition with several other proposed vocoders. All the vocoders were evaluated through an extensive set of Mean Opinion Score (MOS) tests that compared voice quality for different male and female voices in a range of conditions. These conditions included simulations of vehicles traveling at various rates of speed. In addition speech was tested with various background noises, such as sirens, gunshots, and traffic, that are likely to be encountered by a public safety radio system. The result of this evaluation was that the IMBE™ vocoder was judged best by a panel of listeners under almost every test condition. As a result the IMBE™ vocoder was selected as the standard vocoder for the P25 system.

The IMBE™ vocoder is a model-based speech coder, or vocoder, that does not try to reproduce the input speech signal on a sample-by-sample basis. Instead, the IMBE™ vocoder constructs a synthetic speech signal that contains the same perceptual information as the original speech signal. The IMBE™ vocoder is based on the Multi-Band Excitation (MBE) speech model that was developed at the Massachusetts Institute of Technology (MIT) from research on high quality, robust speech modeling.

The IMBE™ vocoder models each segment of speech as a frequency dependent combination of voiced (more periodic) and unvoiced (more noise-like) speech. This ability to mix voiced and unvoiced energy is a major advantage over traditional speech models that require each segment of speech to be entirely voiced or unvoiced. This flexibility gives the IMBE™ vocoder higher voice quality and more robustness to background noise.

The IMBE™ encoder uses sophisticated algorithms to estimate a set of model parameters for each segment of the incoming speech signal. These parameters consist of: (1) a fundamental frequency, to represent the pitch of the speaker; (2) a set of Voiced/Unvoiced (V/UV) decisions, to represent the mixture of voiced and unvoiced energy; and (3) a set of spectral magnitudes, to represent the frequency response of the vocal tract. The encoder computes a Discrete Fourier Transform (DFT) for each segment of speech and then analyzes the frequency content to extract the model parameters for that segment. These model parameters are then quantized into 88 bits, and the resulting voice bits are then output as part of the 4.4 kbps of voice information produced by the IMBE™ encoder. An additional 2.8 kbps of error correction information is then added to the voice information to produce the 7.2 kbps bit stream that is transmitted over the CAI.

The IMBE™ decoder reproduces analog speech from the 7.2 kbps digital bit stream that is received over the CAI. The decoder first uses the error correction information included in the received bit stream to attempt to correct any bit errors that may have been introduced by the radio channel. The decoder then reconstructs the model parameters for each segment and uses these parameters to synthesize both a voiced signal and an unvoiced signal. The voiced signal represents the period portions of the speech and is synthesized using a bank of harmonic oscillators. The unvoiced signal represents the noise-like portions of the speech and is produced by filtering white noise. The decoder then combines these two signals and passes the result through a digital-to-analog converter to produce the analog speech output.

DVSI has also introduced new Enhanced Vocoders for P25 based on DVSI's latest AMBE+2™ Vocoder technology. The Enhanced AMBE+2™ Full Rate Vocoder is fully interoperable with the current P25 7.2 kbps (IMBE™) standard. The AMBE+2™ can also operate at half rates of 3.6 kbps for Phase 2. The AMBE+2™ provides improved voice quality, better noise immunity, tone capability, and other new features. The Enhanced Vocoders significantly improve the voice performance of the P25 system, while facilitating the migration and interoperability between new and existing P25 equipment. DVSI's vocoder technology is used extensively in digital radio systems and in mobile satellite telephony worldwide.

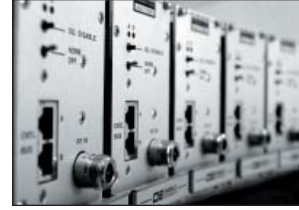

CHAPTER 8: P25 GLOSSARY OF TERMS

Access Method

The ability and means necessary to store data, retrieve data, or communicate with a system. FDMA, TDMA and CDMA are examples.

ALGID

Abbreviation for the eight BITS which identify the encryption algorithm in systems with multiple encryption algorithms.

Algorithm

A finite set of well defined rules for the solution of a problem, in a finite number of steps.

AMBE+2™

Abbreviation for “Advanced Multi Band Excitation”. An enhanced Vocoder that is backwards compatible with IMBE™.

APCO

Abbreviation for “Association of Public-Safety Communication Officials”

APCO Project 16A

A suite of operational requirements developed by APCO for Public Safety trunked radio systems. It is titled “900 MHz Trunked Communications System Functional Requirements Development, Dated March 1979.”

ARQ

Automatic Retry Request to retry corrupted data packets

ASCII

Abbreviation for “American Standard Code for Information Interchange”
- A seven-BIT code that defines 128 characters, including control characters, letters, numbers, and symbols.

Audio throughput delay

Waiting time delay from audio input at sending unit until audio output at receiving unit.

Backward Compatibility

Ability of new units to operate within an “old” system infrastructure or to directly intercommunicate with an “old” unit.

Bandwidth

The difference between the limiting frequencies of a continuous frequency band. Typically measured in Kilohertz. May be considered the amount in kilohertz required for a single communications channel.

BCH

Abbreviation for “Bose-Chaudhuri-Hocquenghem,” a binary coding scheme.

BER

Abbreviation for “BIT Error Rate”

BER Threshold

The level at which the BIT error rate exceeds the error correction capability and communication fails in a digital system.

BIT

Acronym for binary digit.

BIT Rate

In a BIT stream, the number of BIT occurring per unit time, usually expressed as BITS per second or BPS.

BIT Stuffing

A method used for synchronizing BIT streams that do not necessarily have the same or rationally related BIT rates, by adding non-information (“stuffing”) BITS.

BPS

Abbreviation for BITS Per Second, a data rate measure.

BR

Base Radio, a reference designating a base station radio.

C4FM

The acronym for a 4-ary FM transmitter which uses QPSK modulation to work with a CFDD compatible receiver.

CAI

Abbreviation for Common Air Interface.

Call Congestion

The ratio of calls lost due to a lack of system resources to the total number of calls over a long interval of time.

Call Delay

The delay experienced when a call arriving at an automatic switching device finds no idle channel of facility available to process the call immediately.

Call Set-up Time

The overall length of time required to establish a circuit switched call between users or terminals.

Capture Effect

An effect associated with the reception of frequency modulated signals in which if two signals are received on or near the same frequency, only the stronger of the two will appear in the output.

Carrier Noise Level

The noise level resulting from undesired variations of a carrier in the absence of any intended modulation.

Carrier Squelch

A radio receive mode of operation that causes the receiver to unmute in the presence of a received signal.

CDMA

Abbreviation for Code Division Multiple Access. A coding scheme in which digital information is encoded in an expanded bandwidth format. An access method that allocates each user a coded set of channels on which to send outgoing information frames.

CELP

Abbreviation for a “Code Excited Linear Predictive” voice coding technique (analog to digital voice conversion).

CFB

Abbreviation for a “Cipher Feedback” an encryption synchronization method

CFDD

The acronym for a receiver which detects QPSK-C compatible modulation. CFDD stands for Compatible Frequency Discriminator Detection.

Channel

A single unidirectional or bidirectional path for transmitting or receiving, or both, of electrical or electromagnetic signals.

Channel Rate

The data rate at which information is transmitted through the channel, typically stated in BITS per second (BPS).

Channel Spacing

Typically measured in kilohertz from the center of one channel to the center of the next-adjacent-channel. May, or may not, be identical to bandwidth.

C/I

Abbreviation for “Carrier to Interference” signal ratio.

CM

Abbreviation for a “Circuit Merit” A delivered voice quality test and rating strategy

CODEC

A COder-DECoder device (analog to digital voice conversion).

Common Air Interface (CAI)

A radio to radio signal path defined in terms of Access Method, Modulation Scheme, Vocoding Method, Channel Data Rate and Channel Data Format.

Common channel signaling (CCS)

A signaling method using one of the channels on a multichannel network for the control, accounting and management of traffic on all of the channels of the network.

Console

A sub-system comprised of one or more elements from a single manufacturer that is the device(s) which allows a person(s) to effectively and efficiently use and control the capabilities and the functions of the radio system(s) to which it is attached.

Covert

Adjective used to describe undercover operations by government agents. “Covert” communications are generally encrypted.

CQPSK

The acronym for a QPSK IQ transmitter which uses QPSK-C modulation to work with a CFDD compatible receiver.

CRC

Cyclic Redundancy Checksum for data error detection.

CSMA/CD

Abbreviation for “Carrier Sense, Multiple Access” with “Collision Detection.” It is a multi-access technique in which stations listen before transmitting. A transmitting station detecting a collision aborts its transmission.

CTCSS

Abbreviation for “Continuous Tone-Controlled Squelch System.”

CVSD

Abbreviation for “Continuously Variable Slope Delta” modulation technique. A type of delta modulation in which the size of the steps of the approximated signal is progressively increased or decreased as required to make the approximated signal closely match the input analog signal.

DAM

Abbreviation for a “Diagnostic Acceptance Measure.” An audio acceptability test.

DCE

Abbreviation for “Data Circuit terminating Equipment” through which the DTE is connected to a network.

DCPSK

Abbreviation for the “Differential Coherent Phase Shift Keying” modulation technique. A method of encoding information in terms of phase changes, rather than absolute phases, and detected by comparing phases of adjacent BITS.

DCT

Abbreviation for “Discrete Cosine Transform” a technique used in vocoding.

Deadlock

A situation in which traffic ceases to flow and throughput drops to Zero.

De-Key

Turn the transmitter off (release the Push-to-Talk switch).

Delay Time

The sum of waiting time and service time in a queue.

DES-OFB

Abbreviation for “Data Encryption Standard - Output Feedback”

Differential Modulation

A type of modulation in which the choice of the significant condition for any signal element is dependent on the choice for the previous signal element.

DNA

Abbreviation for DEC’s “Digital Network Architecture”.

DPA

Abbreviation for “Demand Protocol Architecture”

DPSK

Abbreviation for “Differential Phase Shift Keying” modulation technique. A method of encoding information for digital transmission. In DPSK, each signal element is encoded as a change in the phase of the carrier with respect to its previous phase angle.

DQPSK

Abbreviation for “Differential Quadrature Phase Shift Keying” modulation technique.

DRT

Abbreviation for a “Diagnostic Rhyme Test” An audio intelligibility test

DS0

Abbreviation for a 64 kbps telephone service

DS1

Abbreviation for a 1.544 MBPS telephone service.

DSP

Abbreviation for “Digital Signal Processor” a specialized microcomputer.

DTE

Abbreviation for “Data Transmission Equipment” (user systems).

DTMF

Abbreviation for “Dual-Tone Multi-Frequency” - a signaling scheme used by the telephone system in which two voice band tones are generated for each keypad key press.

Dual Mode Equipment

Equipment which will transmit and receive information using either the APCO Project 25 standard digital signals or current analog standard signals without modification or interfacing devices.

DVP

Abbreviation for “Digital Voice Protection” - one of several encryption algorithms used to provide secure voice radio transmissions.

ECC

Abbreviation for “Error Correction Code” See Error Correction.

Ed Interface

The label given to the Host and Data Interface in the General System Model.

En Interface

The label given to the Network Management Interface in the General System Model.

Encryption

A coding of plain text (or clear voice) into unintelligible forms for secure transmission.

Error Correction

Digital coding technique for detecting and correcting information transmission errors.

ES

Encryption Synchronization information embedded in a voice data frame

Et Interface

The label given to the Telephone Interconnect Interface in the General System Model.

EVM

Error Vector Magnitude

ETSI

Abbreviation for “European Telecommunications Standards Institute.”

FCC

Abbreviation for “Federal Communications Commission”

FDMA (Frequency Division Multiple Access)

Access method that divides a communication channel into two or more individual channels.

FEC

Abbreviation for “Forward Error Correction”

FIFO

A service discipline of queuing systems, based on the First In, First Out rule.

FIPS

Abbreviation for “Federal Information Processing Standard.”

Firmware

Software that is permanently stored in a hardware device which allows reading and executing the software, but not writing or modifying the software.

Flow Control

In data communications systems, a device function that controls the rate at which data may be transmitted from one terminal so that it is equal to the rate at which it can be received by another terminal.

FNE

Abbreviation for “Fixed Network Equipment.”

Format

In data transmission, the arrangement of contiguous BITS or Frame sequences which make a group, word, message or language.

Frame

In data transmission, the sequence of contiguous BITS bracketed by and including beginning and ending flag sequences. Unit of data of the data link layer.

FS

Frame Synchronization to mark the first information BIT

FSI

Abbreviation for “Fixed Station Interface”.

FSK

Frequency Shift Keying A form of frequency modulation in which the modulating signal shifts the output frequency between predetermined values.

FSNF

Abbreviation for “Fragment Sequence Number Field” in the Common Air Interface.

FTP

Abbreviation for “File Transfer Protocol.”

Full-Duplex

An operating method in which transmission is permitted, simultaneously, in both directions of a telecommunications channel.

G Interface

The label given to the Inter Sub-System Interface in the General System Model.

Galois Field (GF)

A data field used to calculate parity checks for a Reed-Solomon code.

Gateway

An interface that provides the necessary protocol translation between disparate networks.

GMSK

Abbreviation for “Gaussian Minimum Shift Keying” A form of frequency modulation in which the modulating signal shifts the output frequency between predetermined values. A form of MSK which uses Gaussian low pass filtering of the binary data to reduce sideband energy.

Golay

Name of a standard error correction code

GPS

Abbreviation for “Global Positioning System”

Graceful Close

Method used to terminate a connection at the transport layer with no loss of data.

GSM™

Abbreviation for “Group Specialized Mobile” radio service

Half-Duplex

That mode of operation in which communications occurs between two terminals in either direction, but only one direction at a time. May occur on a half-duplex or duplex circuit but not on a simplex circuit.

HDLC

Abbreviation for “Highlevel Data Link Control.” The international standard for data link control developed by ISO.

Hex BIT

6 BITs grouped together to represent a Reed-Solomon code symbol

Hierarchical Numbering

Multiple level numbering. An example is the telephone number made up of levels such as “Country Code,” “Area Code,” “Exchange Number” and “Line Number.”

Hierarchical Routing

Multiple level routing. Used both in packet switching and circuit switching.

Hub Polling

One of the polling techniques. Permission to transmit is passed sequentially from one designated user to another.

I/O

Abbreviation for “Input and/or Output.”

IEEE

Abbreviation for “Institute of Electrical and Electronics Engineers, Inc.”

ILS

Abbreviation for an “Input buffer Limiting Scheme.” A flow control scheme that blocks overload locally generated arrivals by limiting their number at a buffer.

IMBE™

Abbreviation for “Improved Multi Band Excitation”.

Inband Signaling

Signaling that uses frequencies or time slots within the bandwidth of the information channel.

Incarnation Number

A unique name or number sent within a data unit to avoid duplicate data unit acceptance.

IP

Abbreviation for “Internetwork Protocol” in the ISO activities, as well as Internet Protocol in ARPA protocol activities.

IPR

Abbreviation for “Intellectual Property Rights”. Patents, Copyrights or similar rights which are proprietary to an individual, group or company.

IQ Origin Offset

Is a measurement that shows how well balanced the IQ modulators in the transmitter are and if there is excessive leakage around them.

IRAC	Abbreviation for the Federal Government "Interdepartmental Radio Advisory Committee."	Local Area Network (LAN)	A network covering small geographic areas.
ISDN	Abbreviation for "Integrated Services Digital Network" All-digital network handling a multiplicity of services with standard interfaces for user access. An integrated digital network in which the same time-division switches and digital transmission paths are used to establish connections for different services.	LSB	Abbreviation for "Least Significant BIT."
ISO	Abbreviation for "International Standards Organization"	LSD	Low Speed Data embedded in digital voice
Key	The parameter defining an encryption code or method.	LU	Abbreviation for "Logical Unit."
Key Tag	The parameter defining one of several encryption codes or methods.	MDT	Abbreviation for "Mobile Data Terminal"
KID	Sixteen BITS which identify the encryption key in systems with multiple encryption keys.	MFID	Abbreviation for "Manufacturer's Identity." An eight-BIT field identifying manufacturer of the radio equipment.
LAN	Abbreviation for "Local Area Network."	MI	Message Indicator to initialize encryption
LC	Link Control information embedded in digital voice	MIB	Abbreviation for "Management Information BITS."
Linear Amplifier	A radio final amplifier in which the output is linearly proportional to the input. Usually a class A amplifier.	MIL-STD	Abbreviation for "Military Standard".
Linearized Amplifier	A radio final amplifier in which the output is mostly linearly proportional to the input. Usually a class AB amplifier.	MODEM	An acronym for MOdulator/ DEModulator. A device for converting digital signals into quasi-analog signals for transmission over analog communications channels and for reconverting the quasi-analog signals into digital signals.
LLC	Logical Link Control sublayer of the OSI Data Link Layer	Modulation	A controlled variation of any property of a carrier wave for the purpose of transferring information.
LMR	Abbreviation for "Land Mobile Radio"	MOS	Abbreviation for "Mean Opinion Score." An audio quality test.
		MR	Mobile Radio, a reference designating a mobile or portable subscriber unit
		MSB	Abbreviation for "Most Significant BIT."

MSK
 Abbreviation for “Minimum Shift Keying.”
 A form of frequency modulation in which the modulating signal shifts the output frequency between predetermined values. Sometimes called fast frequency shift keying.

NASTD
 Abbreviation for “National Association of State Telecommunications Directors.”

NCS
 Abbreviation for “National Communications Systems group” a U.S. Federal agency.

NID
 Network Identifier code word following the frame sync

NIST
 Abbreviation for “National Institute of Standards and Technology” a U.S. Federal agency.

NPSPAC
 Abbreviation for “National Public Safety Planning Advisory Committee” A user/industry advisory committee established by the Federal Communications Commission to develop a plan for the use of the 800 MHz Public Safety spectrum.

NSA
 Abbreviation for the U.S. Federal Government “National Security Agency.”

NTIA
 Abbreviation for “National Telecommunications and Information Administration”. a U.S. Federal agency.

Octal
 Base 8 notation for numbers, also called radix 8

Octet
 Eight BITs grouped together, also called a byte

OFB
 Abbreviation for a “Output Feedback.”
 An encryption synchronization method.

Open System
 A system whose characteristics comply with specified standards and that therefore can be connected to other systems that comply with these same standards.

Open Systems Interconnection (OSI)
 A logical structure for network operations standardized within the ISO; a seven-layer network architecture being used for the definition of network protocol standards to enable any OSI-compliant computer or device to communicate with any other OSI-compliant computer or device for a meaningful exchange of information

Operating System
 An integrated collection of routines that service the sequencing and processing of programs by a computer. Includes such functions as memory allocation, file management, input and output operations, communications and interfacing to other application software.

OTAC
 Abbreviation for “Over-The-Air-Control.”

OTAP
 Abbreviation for “Over-The-Air-Programming.”

OTAR
 Abbreviation for “Over-The-Air-Rekeying.”

Packet
 A sequence of binary digits, including data and control signals, that is transmitted and switched as a composite whole. The data, control signals and possibly error control information, are arranged in a specific format.

Packet Switching
 The process of routing and transferring data by means of addressed packets so that a channel is occupied during the transmission of the packet only, and upon completion of the transmission the channel is made available for the transfer of other traffic.

PBX	Abbreviation for "Private Branch Exchange." A privately owned switch, generally of relatively small size, connected via output trunks to the public switched telephone network.	Protocol	A set of unique rules specifying a sequence of actions necessary to perform a communications function.
PCM	Abbreviation for "Pulse Coded Modulation." That form of modulation in which the modulating signal is sequentially sampled, quantized, and coded into a binary form for transmission over a digital link.	PSDN	Abbreviation for "Public Switched Data Network."
PDT	Abbreviation for "Portable Data Terminal"	PSK	Abbreviation for "Phase Shift Keying." A method of modulation used for digital transmission wherein the phase of the carrier is discretely varied in relation to a reference phase, or the phase of the previous signal element, in accordance with the data to be transmitted.
$\pi/4$ DQPSK	Abbreviation for "Differential Quadrature Phase Shift Keying" modulation technique. $\pi/4$ indicates 90° phase angles.	PSTN	Abbreviation for "Public Switched Telephone Network."
$\pi/4$ QPSK	Abbreviation for "Quadrature Phase Shift Keying" modulation technique. PSK using four phase states. $\pi/4$ indicates 90° phase angles.	PTT	Abbreviation for "Push-to-Talk", the switch on a subscriber unit which, when pressed, causes the subscriber unit to transmit.
PN Sequence	A pseudo random BIT sequence used in vocoding.	Quadrature Modulation	Modulation of two carrier components 90° apart in phase by separate modulating functions.
Polling	A network control system in which a designated control station invites its tributary stations to transmit in any sequence specified by the control station.	QAM	Abbreviation for "Quadrature Amplitude Modulation." Quadrature modulation in which some form of amplitude modulation is used for both inputs.
POTS	Abbreviation for "Plain Old Telephone Service."	QPSK	Abbreviation for "Quadrature Phase Shift Keying" modulation technique. PSK using four phase states.
PPP	Abbreviation for "Point-to-Point Protocol."	Reed-Solomon (RS)	An error correction coding scheme for binary data fields.
Processing Delay	The time in ms required for the coding and decoding of voice or data information.	Reference Vocoder	The particular implementation of the APCO Project Vocoder available from Digital Voice Systems Incorporated as Model VC-20-PRJ25. This is the agreed upon reference implementation of the APCO Project 25 Vocoder.

RF

Abbreviation for “Radio Frequency.”

RF Sub-System

The RF infrastructure which is bounded by the five open APCO Project 25 interfaces and three standard computer network gateway interfaces. It is the RF equipment and related non standard peripheral equipment which provides a standardized RF communication channel. One of the APCO Project 25 interfaces is the Common Air Interface (CAI).

RS-232

An asynchronous, serial, data transmission standard that defines the required sequence, timing, and hardware interface.

RS

Reed-Solomon error correction code.

RTP

Abbreviation for “Real-time Transport Protocol”.

SAP

Service Access Point, where a network provides a service.

Setup Delay

The time in ms required to actuate equipment for transmission and reception.

Signal

The detectable transmitted energy which carries information from a transmitter to a receiver.

SINAD

Abbreviation for “Signal plus Noise And Distortion” to “noise and distortion” ratio.

SMRS

Abbreviation for “Specialized Mobile Radio Service.”

Squelch

A radio circuit that eliminates noise from the speaker when no transmitted signal is present.

STC

Abbreviation for “Sinusoidal Transform Coding” A voice coding technique (analog to digital voice conversion).

Subscriber Unit

A mobile or portable radio unit used in a radio system.

Sub-System

A defined portion of any organized assembly of resources and procedures united and regulated by interaction or interdependence to accomplish a set of specific functions.

System

Any organized assembly of resources and procedures united and regulated by interaction or interdependence to accomplish a set of specific functions.

T1 system

A digital communication system designed to handle 24 voice channels at 64 kbps each. Digital transmission media to support 1.544 Mbps. transmission speed.

TCP

Abbreviation for “Transmission Control Protocol.” ARPAnet developed transport layer protocol.

TDMA (Time Division Multiple Access)

A communications technique that uses a common channel for communication among multiple users by allocating unique time slots to different users.

Telnet

Terminal-remote host protocol developed for ARPAnet.

TGID

Abbreviation for “Talk-Group Identifier.” A sixteen BIT field identifying talk-group of the radio message.

Throughput Delay

The total time in ms between the initiation of a voice or data signal, ie. push-to-talk, until the reception and identification of the identical signal at the received output speaker or other device.

TIA

Abbreviation for “Telecommunications Industry Association”

Time-Out-Timer

A function that limits the transmission period to a pre-defined time. The user will automatically stop transmitting when the timer goes off after the pre-defined time.

TPDU

Abbreviation for “Transport Protocol Data Unit.”

Transmission Delay

The time in ms required for transmission of a voice frame or data packet through a communication channel.

Trellis Code

Type of error correcting code for digital modulation

TriBIT

3 BITS grouped together into a symbol for a trellis code

TRS

Technical Requirements Specification

Trunk

A single transmission channel between two points that are switching centers or nodes, or both.

Trunked (system)

Systems with full feature sets in which all aspects of radio operation, including RF channel selection and access, are centrally managed.

UDP

Abbreviation for “User Datagram Protocol”.

ULP

Abbreviation for “Upper Layer Protocol”. Layer above TCP.

Um Interface

The label given to the Common Air Interface reference point in the General System Model.

VOCODER (Voice-Coder)

A type of voice coder. Usually consisting of a speech analyzer and a speech synthesizer which convert analog speech into digital signals for transmission and digital signals back into artificial speech sounds for reception.

VSELP

Abbreviation for a “Vector Sum code Excited Linear Predictive” voice coding technique (analog to digital voice conversion).

WAN

Abbreviation for “Wide-area Network”

X.25

The CCITT three-layered interface architecture for packet switching connecting a DTE to a DCE.

Daniels Electronics Ltd.
43 Erie Street, Victoria, BC
Canada V8V 1P8
www.danelec.com
sales@danelec.com

Toll Free Canada and USA:
phone: 1-800-664-4066
fax: 1-877-750-0004

International:
phone: 250-382-8268
fax: 250-382-6139

© 2007 Daniels Electronics Ltd.
All Rights Reserved.

TG-001-2-0-0



www.danelec.com