

Inter Sub-System Interface - ISSI EADS ISSI White Paper

July 2006

W. Roy McClellan III, P.E.
Standards and Regulatory
EADS Secure Networks
6801 Gaylord Parkway
Suite 305
Frisco, TX 75034
Visit us on line at www.eads-ps.com



Introduction

The development and publication of the Project 25 Inter-RF Sub-System Interface (ISSI) is a significant milestone in the efforts to improve communications among Public Safety Officers and First Responders. The ISSI provides a standardized, system-level interface for Project 25 (P25) systems and offers non-P25 legacy systems a clearly defined path to allow them to connect to P25 systems.

The need for conformance to a standard is clear. Without a standard, communications in the Public Safety community will continue to be fragmented and disjointed in an environment where fragmentation and disjointed behaviors cost lives. While the public sees this impact in major events like the Oklahoma City bombing, the 9/11 terrorist attacks, and the Hurricane Katrina response, every Public Safety agency can relate local examples that happen daily during fires, car chases, bank robberies and officer-involved shootings. Public Safety needs the ability to communicate and the Public Safety community must stand together to foster the adoption and independent certification of the Public Safety user defined P25 standards.

P25 does not resolve all the issues today. It does however lay the foundation to build toward a long-term solution. Every non-P25 Public Safety communication system cannot be scrapped and replaced instantly. Older legacy systems will be replaced with new P25 systems. Vendors of newer non-P25 systems will build P25 gateways utilizing the P25 ISSI to connect legacy systems to new P25 systems. Leveraging the P25 air interface standards and the new P25 ISSI standard, new vendors will continue to enter the market generating true competition, choice, and driving innovation.

This paper introduces the concepts behind the P25 ISSI. It describes the solutions the ISSI brings to critical inter-agency communication needs while ensuring agencies control and choice over their networks. It emphasizes the importance of laying the right foundations for the future of Public Safety communications. Networks that are deployed today must allow a seamless migration towards an ISSI based, “system of systems” model. This requires the implementation of the architectural principles of the P25 ISSI now.

ISSI concepts

ISSI as part of the suite of P25 Standards

The Project 25 and Telecommunications Industry Association (TIA) series of documents (TIA-102) describe an open architecture, based on standard interfaces, for Public Safety mission critical digital radio communications. Interfaces are defined around a core P25 radio network called the Radio Frequency Sub-System (RFSS). Now that the ISSI interface is defined, two other interfaces leveraging the ISSI standard are being drafted and will be introduced in the near future. Along with the ISSI, these important interfaces, the Fixed Station Interface (FSI) and the Console Sub-System Interface (CSSI) are shown in the figure below.

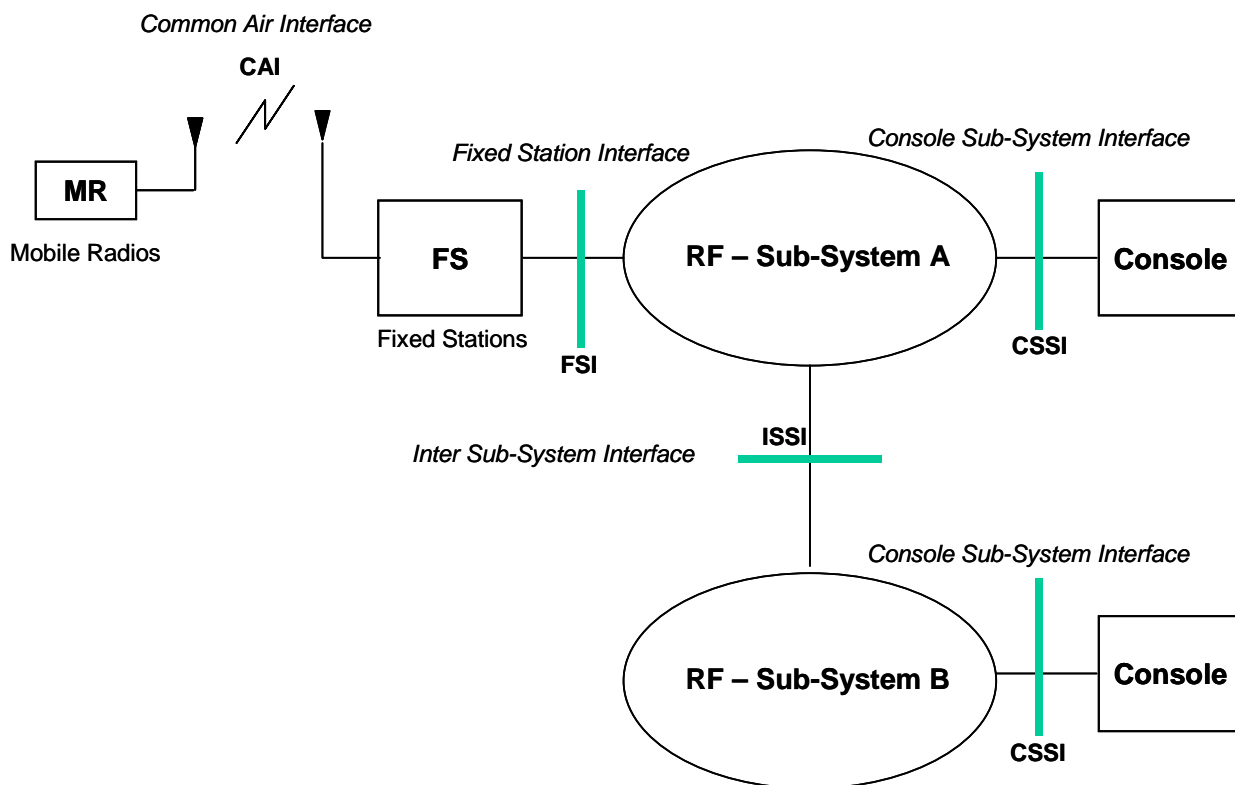

The majority of the TIA/P25 standards focus on the radio Common Air Interface (CAI). The CAI allows P-25 compliant radios from different vendors to talk to each other (talk-around or within a network) if they support the same frequency band. It also allows radios from agency A to be used on agency B's network, if authorized and in the same frequency band, even if radios and the network come from different vendors. Prior to the creation of the ISSI standard, a radio network of multiple RFSS had to come from the same vendor and were interconnected via proprietary protocols. The ISSI now adds an important dimension with the ability to tie different vendors RFSS together into wide area networks and thus a "system of systems."

The introduction of the ISSI provides a defined standard to interconnect different networks, regardless of frequency band or suppliers, together in such a way to allow roaming (mobility) of subscriber radios between networks. The ISSI supports dynamic, transparent and fully featured operations (e.g. PTT management) for individual and group calls across network boundaries. This is what the ISSI is about.

Utilizing similar protocols as the ISSI, the P25 conventional Fixed Station Interface (FSI) has been defined to facilitate the integration of fixed stations and the RFSS. Similarly, the Console Sub-System Interface (CSSI) is designed to facilitate integration of consoles with the RFSS. The ISSI is being optimized to facilitate CSSI operations over the ISSI to ensure consoles connected to different RFSS can communicate with each other and for cross RFSS console support.

ISSI features and benefits

The ISSI includes the following features:

- Authentication of roaming radios
- Tracking current location of roaming radios (subscriber database management)
- Voice transport
- P25 addressing scheme
- Unit/Group Call setup & teardown
- Home-based PTT services to roaming radios
- PTT communications management among roaming and home-based radios

The ISSI is an open IP-based interface relying on standard IP protocols for voice transport (using Real-time Transport Protocol - RTP) and signaling (using Session Initiation Protocol – SIP).

As a standard, the ISSI provides the unique capability to connect different vendor networks together, the same way CDMA and GSM networks can be connected today based on their own standards.

By supporting individual and group calls as well as PTT across networks, the ISSI allows radios operating under network A's coverage and radios operating under network B's coverage to communicate as if they were under a unique network. This applies independently of the frequency band used in network A and in network B, and whether network A's coverage and network B's coverage overlap or not.

An additional feature of this network connectivity is the ISSI's ability to support authentication and registration of roaming radios. The ISSI allows radios from network A to operate under network B's coverage assuming the same frequency band. This includes the capability for network A to track and control its radios when they are under network B's coverage and to dynamically include them in individual and group calls with no loss of features (including PTT and trunking). It also gives network B control of visiting radios based on inter-agency agreements.

These capabilities become particularly useful to support border areas between networks and when joint operations from neighboring agencies become necessary.

ISSI standardization history and future applications

Early attempts in the 1990s by P25 and TIA to define the ISSI used a set of intersystem messages culled from the GSM Mobile Application Part (GSM MAP). However this did not address certain critical issues between systems such as registration of mobiles. Additional work explored the use of the Signaling System #7 (SS7) protocol, based on GSM MAP, or the ETSI Terrestrial Trunked Radio (TETRA) solution, based on QSIG, which both proved to be unfeasible.

In early 2000, the TIA and Project 25 made a decision to explore the use of the emerging IETF Session Initiation Protocol (SIP) standard as a basis for a new all IP based ISSI. The TIA and Project 25 leadership felt that the amount of time and energy that would be required to develop the ISSI was best invested into an all IP based standard versus circuit switched technology. The TIA and Project 25 sub-committees debated the merits of SIP and analyzed SIP characteristics and latencies before making a decision to proceed with the development of a SIP based standard in 2002. A preliminary SIP standard was introduced in 2004 and a formal ballot was undertaken in 2005. Ballot comments and comments resolution extended until 2006, with the ISSI document approved for publication in June of 2006.

The published document represents the ISSI for Trunked Voice Systems. Further work is in progress to address conventional operations, console operations, packet data, supplementary data, and Over-The-Air-Rekeying (OTAR) as supplements or addendums.

EADS and Nortel provided critical early expertise in promoting the use of SIP as the call control mechanism (e.g. call setup and tear-down). This work led to the creation of an initial document for technical discussions. Other key contributors such as EF Johnson, Lucent, M/A-COM, NTIA/ITS (Institute for Telecommunications Sciences in Boulder, CO), and Motorola provided valuable input and comments on the critical in-call control and voice packet transport mechanisms using the Real-time Transport Protocol (RTP).

ISSI solutions to inter-agency communication needs

SAFECOM Interoperability Continuum

The ISSI solution is a key architectural and technical element to improve interoperability among agencies. However, as described in the SAFECOM Interoperability Continuum, technology alone cannot solve all issues related to interoperability. Usage, Training & Exercises, Standard Operating Procedures and Governance must be synchronized for the technology to be effective.

The ISSI implementation requires two fundamental operating elements to deliver the level of interoperability expected, as well as ensuring that control and choice over their network is maintained for each agency:

- First it needs cooperation between network operators in order to define the rules that will govern their inter-working. These rules include agreements for:
 - numbering plans - in order to avoid duplication of numbers between two agencies
 - list of users, equipment, and groups allowed to roam, with associated authorized time and location
 - list of services allowed for roaming users and groups, with associated authorized users, time, and location
 - Service Level Agreements (SLA) for those services that are provided to roamers.
- Second each agency must implement mechanisms to ensure the security of its own network (protection against unauthorized users, wrong use of services, wrong use of ISSI, ...) as well as mechanisms to ensure that resources allocation are planned and controlled such that traffic during peak operations do not affect the capabilities of Public Safety users to communicate as needed. Some examples of this includes :
 - Control and denial of un-authorized users at a visited RFSS
 - Prevent un-authorized foreign registration at the home RFSS
 - Ensure that services to native users will not be impacted by the intrusion of too many foreign users in a visited RFSS

Interoperability scenarios described throughout this document make the assumption that Governance rules between agencies have been agreed, that Standard Operating Procedures and Mechanisms have been harmonized, and that Public Safety officers and Command & Control staff have been trained.

ISSI Architecture, Messages and Procedures

ISSI “Home oriented” Architecture

The ISSI architecture is based on the concept of a “home” and a “serving” RFSS:

- The “home” RFSS represents the normal location and radio coverage area under which a particular talk group and/or individual operates.
- A “serving” RFSS represents a foreign location and radio coverage area to which a talk group (or certain members of a talk group) and/or individual has roamed, and is not the native network to that user and/or talk group.

A general principle of the ISSI is to be “home oriented”, which means that any decision regarding subscribers, groups and calls is taken at their home RFSS.

ISSI Procedures

The core of the ISSI is based on procedures defined to manage mobility, to control individual and group calls, and to manage Push-To-Talk services.

Mobility Management procedures

The Mobility Management procedures allow:

- A Subscriber Unit to access services outside of its home RFSS;
- A Group to be expanded outside of its home RFSS.

A Subscriber Unit (SU) moving outside its home RFSS radio coverage will be able to register and to affiliate with the Group it is interested in when within the radio coverage of a serving RFSS (assuming compatible radio frequencies) and allowed to operate according to a mutual agreement between the owning agencies of the SU “home” RFSS, the Group “home” RFSS and the “serving” RFSS.

The “serving” RFSS to which the SU has roamed has the responsibility to inform the “home” RFSS of the SU of the individual’s new location. If the SU wants to affiliate with a Group, the “serving” RFSS also has the responsibility to inform the “home” RFSS of its interest in that Group by registering to that Group.

The “home” RFSS of the SU and the “home” RFSS of the Group update their databases so when the need to connect a call to those roaming talk groups or individuals occurs, the networks know where the SU or the Group’s members are located.

The Home RFSS and the Serving RFSS can be either in the same P25 System (Intra system) or in different P25 Systems (Inter system) within a Wide Area Communication Network (WACN).

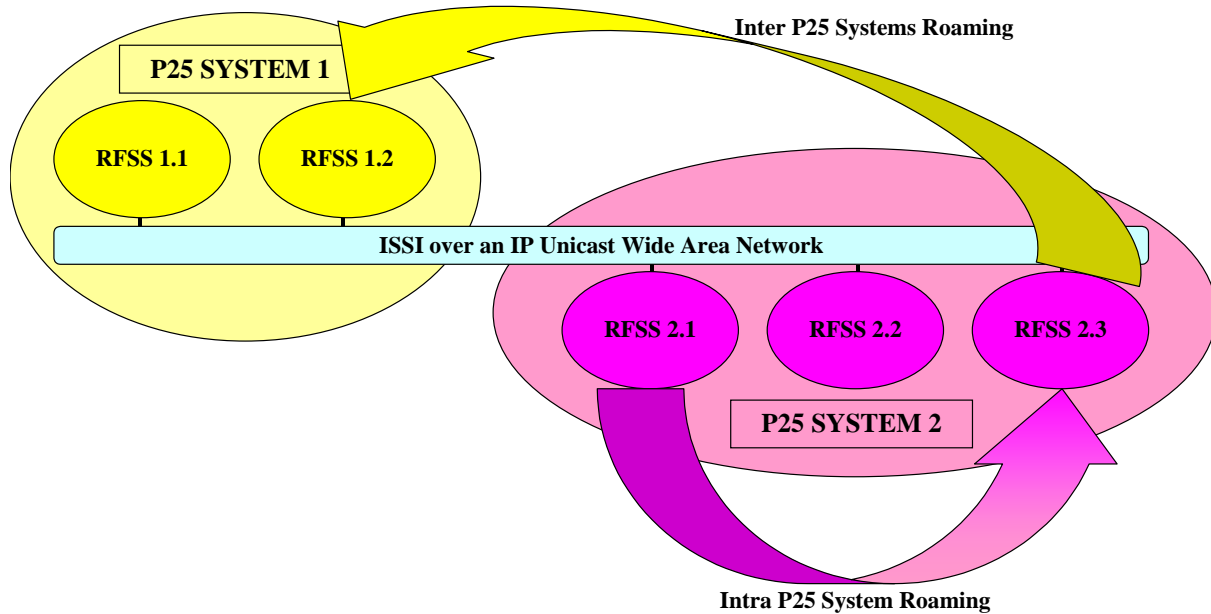

The Mobility Management procedures allow a roaming SU to keep contact with its agency, wherever it is located. It also allows a SU in its “home” RFSS and in a “serving” RFSS to express its interest in a Group owned by third RFSS in order to have this Group expanded to the RFSS where it is registered. Thus group communication can be dynamically expanded over several RFSS according to the operational needs of the users. The Mobility Management procedures of the ISSI rely on the SIP REGISTER method.

Five Mobility Management procedures are defined over the ISSI:

Registration	used by a Serving RFSS to register and authenticate an SU or to register interest in a Group
Serving Query	used by a Serving RFSS to query a Home RFSS for service profile information for an SU or a Group
Home Query	initiated by a Serving RFSS to remove interest in an SU or a Group, or to command a roaming SU to re-register
Deregistration	initiated by a Serving RFSS to remove interest in an SU or a Group
Roamed	initiated by a Home RFSS to inform a Serving RFSS that an SU that was previously in its domain has moved to a different domain

A typical use case of the Mobility Management procedure is the following:

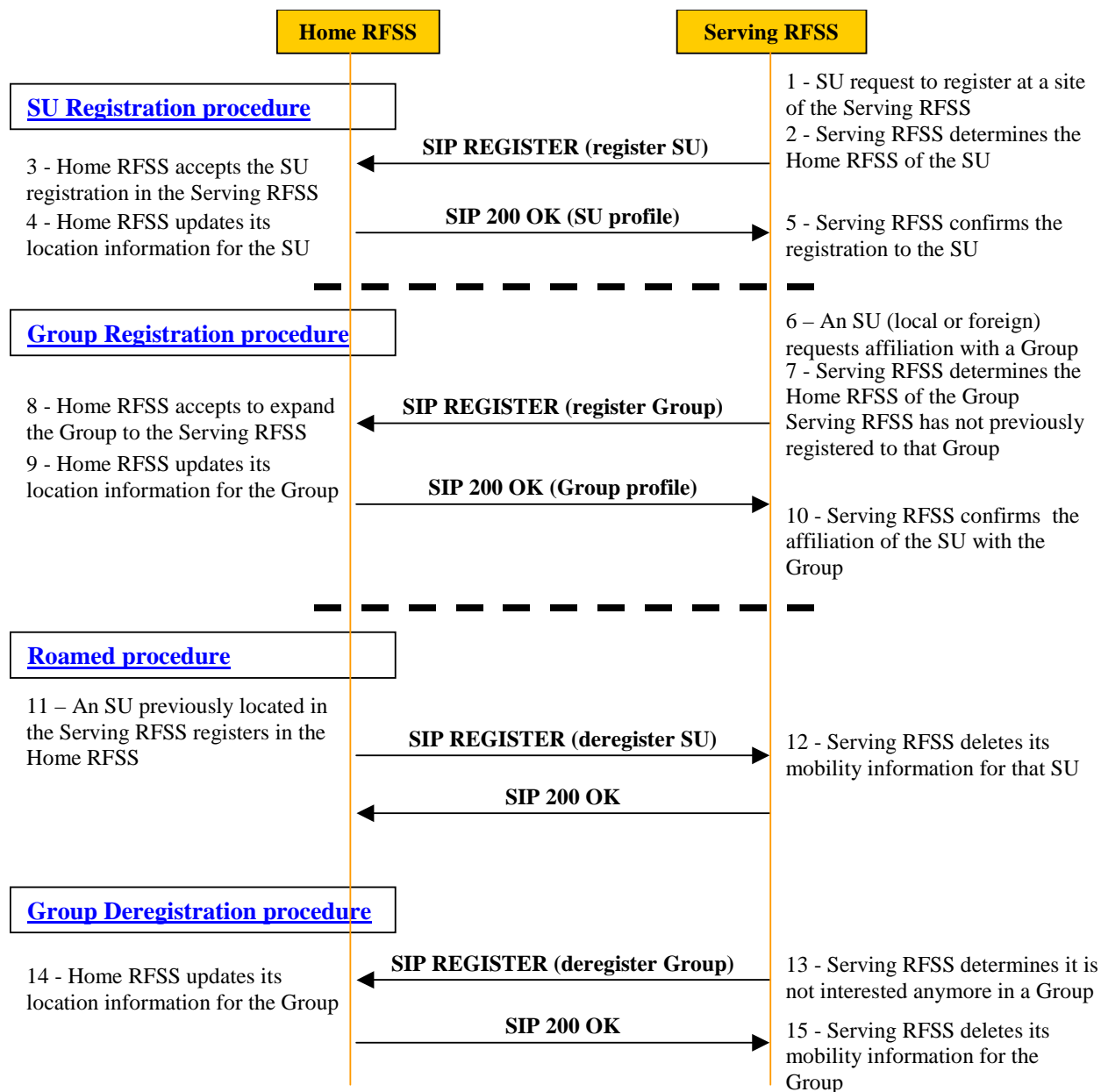

Call Control procedures

The Call Control procedures define Unit-to-Unit calls and Group calls over several RFSS'. A Unit-to-Unit call can be set-up dynamically between any two Subscriber Units that can be each located at their Home RFSS or at any Serving RFSS. The Unit-to-Unit call is managed by the Home RFSS of the calling party and will involve the Home RFSS of the called party and the Serving RFSS(s) where each party is registered.

A group call can be set-up over several RFSS, based on the registrations to that Group that have been requested by any serving RFSS, and using the Mobility Management procedures. Following the “Home oriented” principle of the ISSI, the Group call is handled by the Home RFSS of the Group.

The Call Control procedures rely mainly on SIP methods for session initiation (SIP INVITE) and termination (SIP BYE). The associated RTP session to support the voice media flows is negotiated, set up and torn down together with the SIP session. The typical messages sequence (only the most relevant messages have been included) for a Unit-to-Unit Call between a roaming SU and an SU at its Home RFSS is as follows:

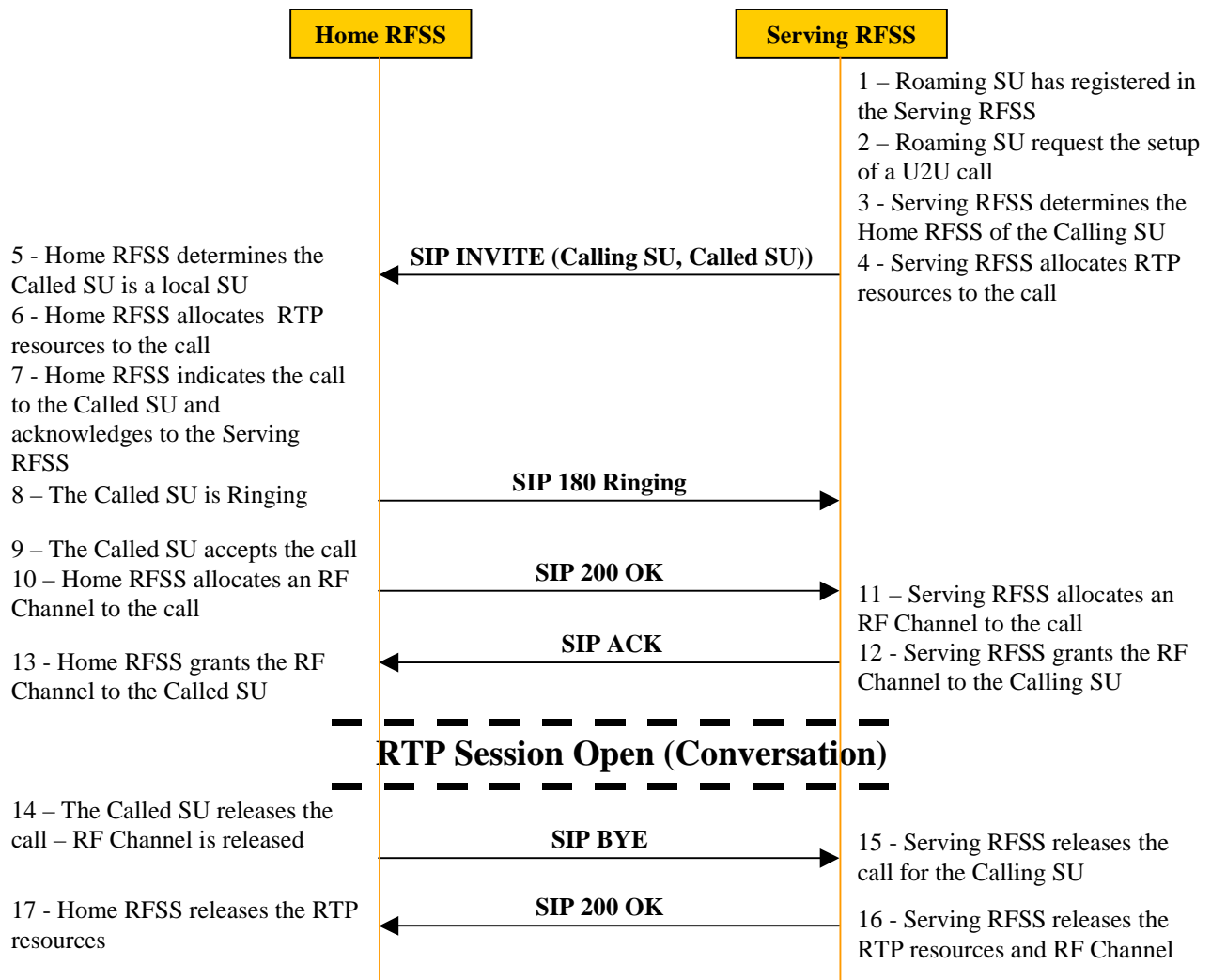

The typical messages sequence for a Group Call initiated at a Serving RFSS is as follows:

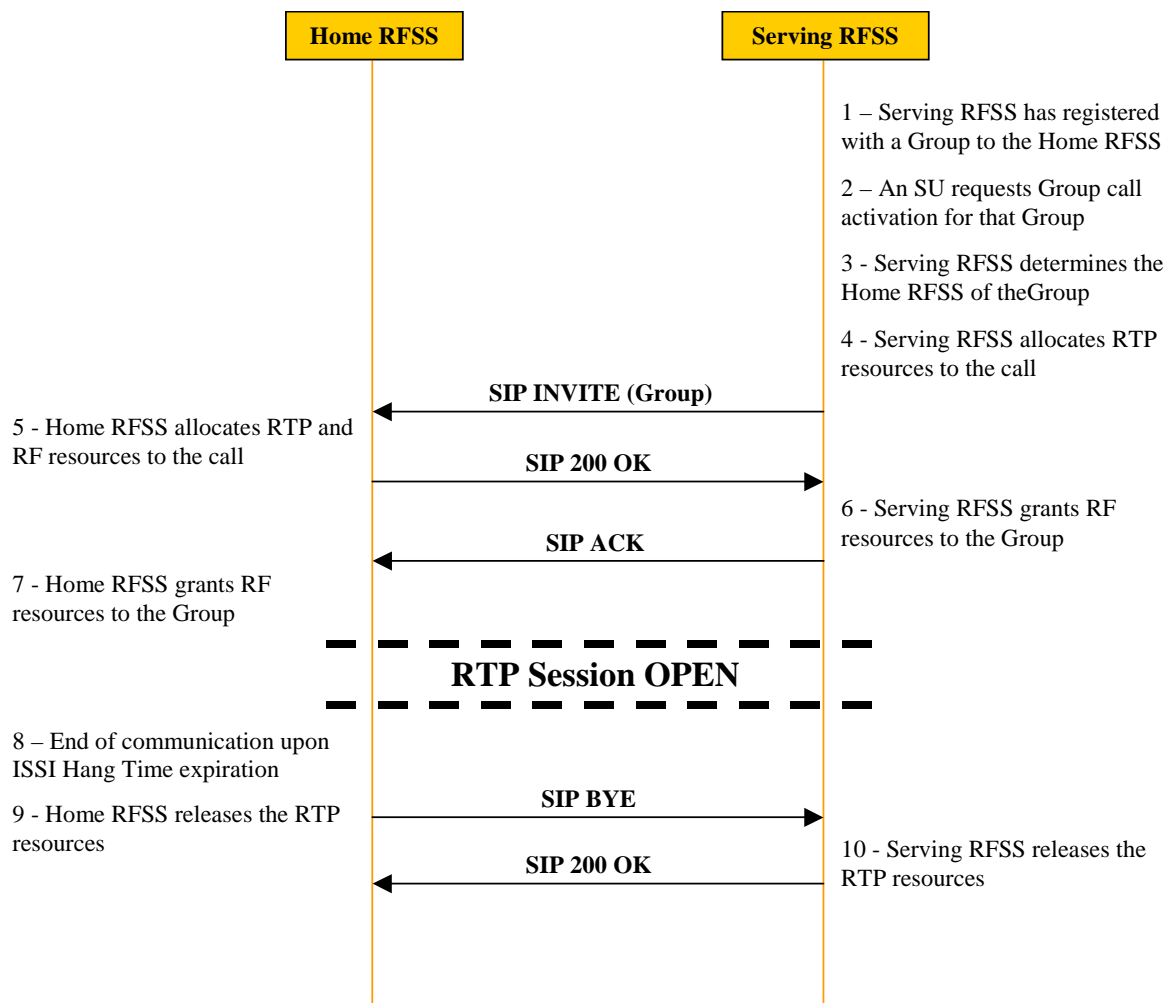

Push to Talk Management procedures

The target of the Push to Talk (PTT) Management procedures is to allow the control of the RTP voice media transmission between the RFSS involved in a voice call.

The PTT Management procedures state behaviors and arbitration rules applied by the Master Media Function (MMF) and by the Subordinate Media Functions (SMF). The main control functions are:

- Request by a Serving RFSS for permission to transmit RTP voice payload;
- Queuing, Granting or Denying by a Home RFSS of permission to transmit;
- Initiation by a Home RFSS of outbound RTP voice payload;
- Management of Loosing Audio by a given RFSS;
- Termination of PTT transmission from a given RFSS;
- Muting of undesired audio by a Home or Serving RFSS.

For a Group call, the Master Media Function is located at the Home RFSS of the Group. For a Unit to Unit call, the Master Media Function is located at the Home RFSS of the Called Party.

The typical PTT exchanges in a call involving a Home RFSS and a Serving RFSS are as follows:

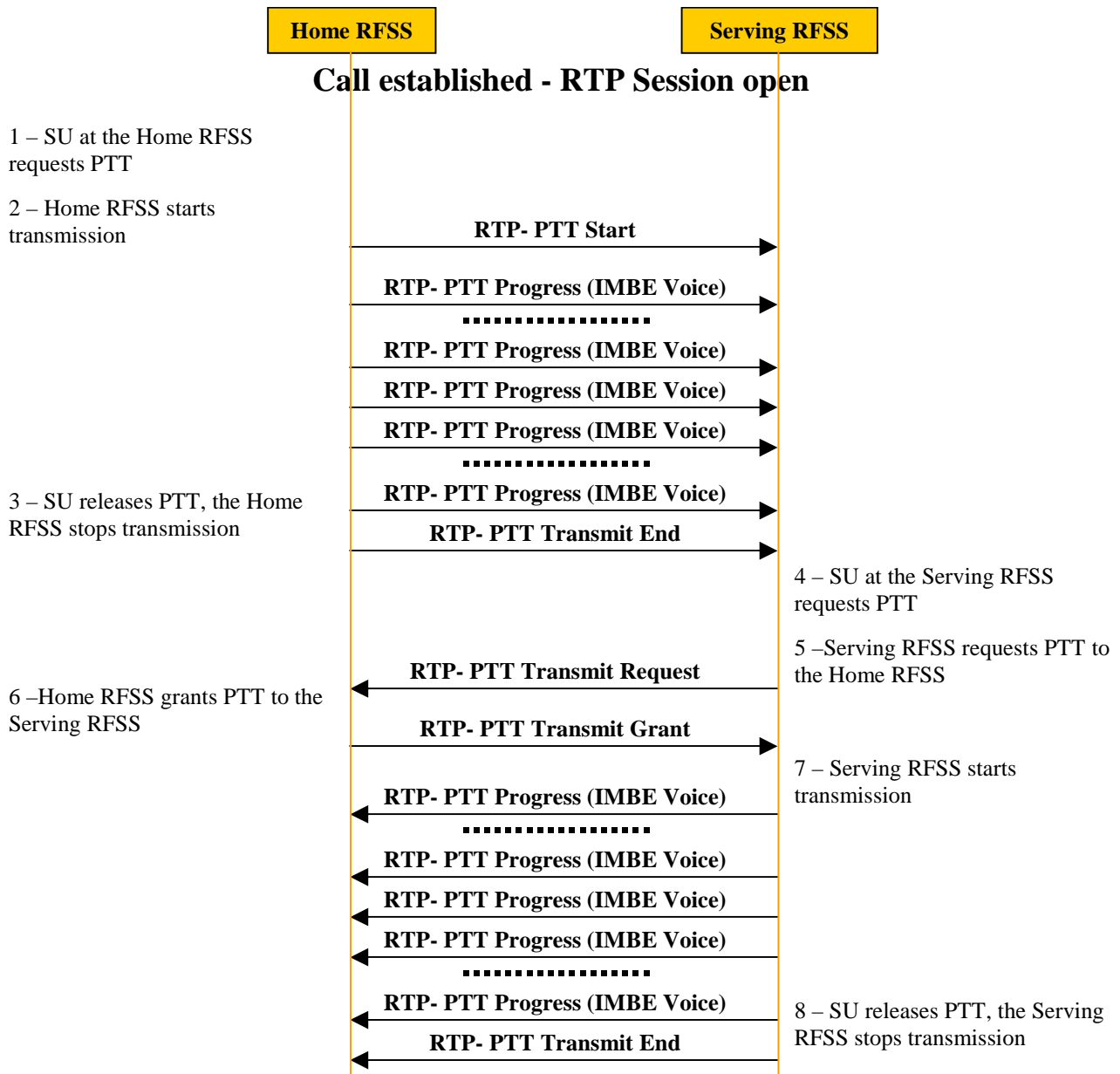

Examples of ISSI use for agency interoperability

Extending home network reach through roaming in the same frequency band

On a daily basis, the Police Department of City A needs to collaborate with the Police Department of City B. Each city has a P25 trunked radio infrastructure from a different vendor. Both networks are operating in the same 700 MHz public safety spectrum and are inter-connected through the P25 ISSI. Their coverage does not overlap.

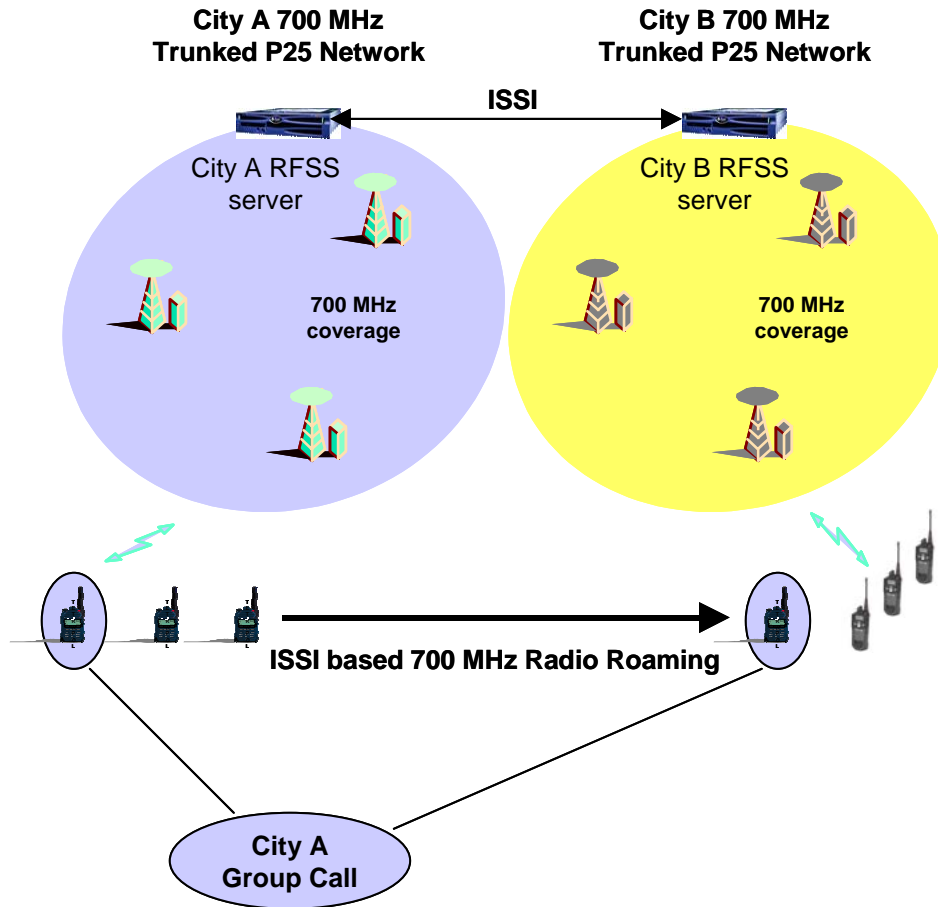

ISSI based Roaming provides users from City A remote access to home Group Call when under City B coverage

Governance rules between cities A & B have been defined, users are aware of the capability of both systems to provide seamless roaming and communication facilities across the two networks.

Radios are normally operated in their “Home” network, using the resource provisioned by their “Home” city network. However, when needed, users from network A (and vice-versa) are moving towards network B.

Let's take the example of a user from Network A roaming under Network B's coverage. Thanks to the ISSI, registration of the user from Network A, now roaming under Network B's coverage is provided to the "Home" RFSS server of city A. Network A now has location and registration information of the roaming user.

SU Registration procedure

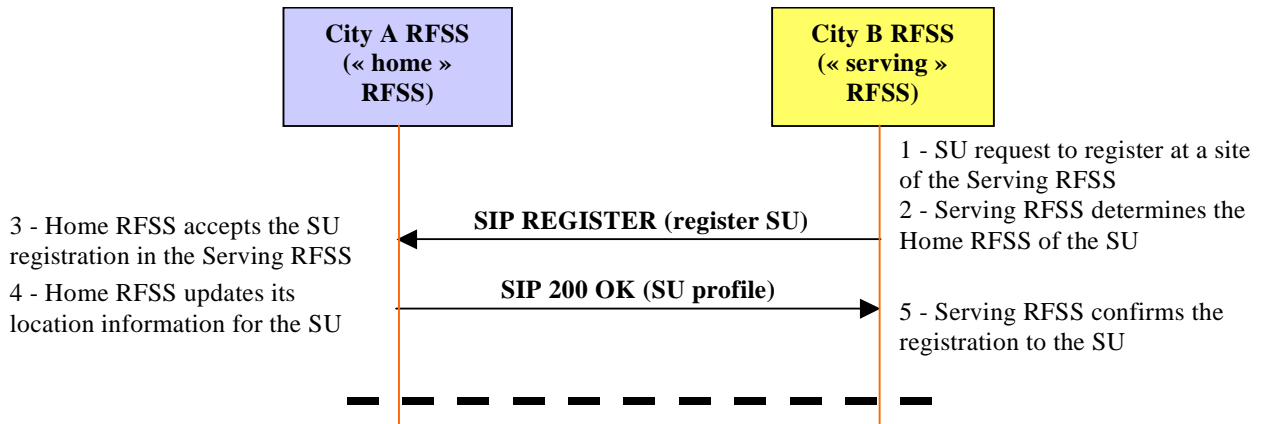

The roaming unit wants to remain connected to its usual talk group, on Network A, so that he can be in contact with its Command & Control staff (including console of city A). The ability for the roaming unit to be able to listen and talk to its usual talk group, (on Network A while under Network B coverage) involves two ISSI procedures: Group Registration and Group Call Initiation.

Group Registration procedure

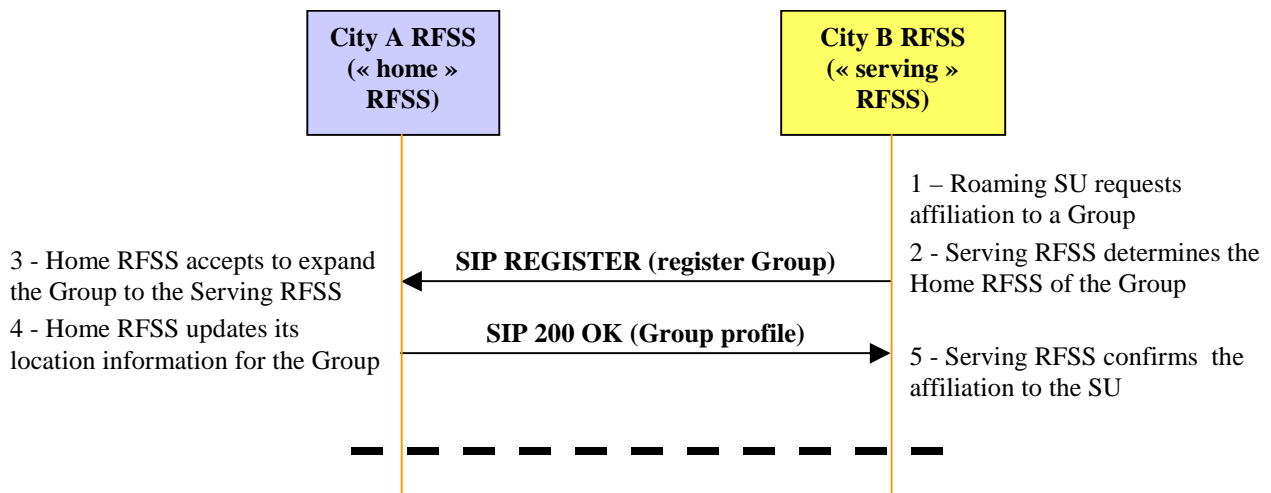

The roaming unit is now registered to its usual talk group through the ISSI registration procedures.

Group Call Initiation procedure

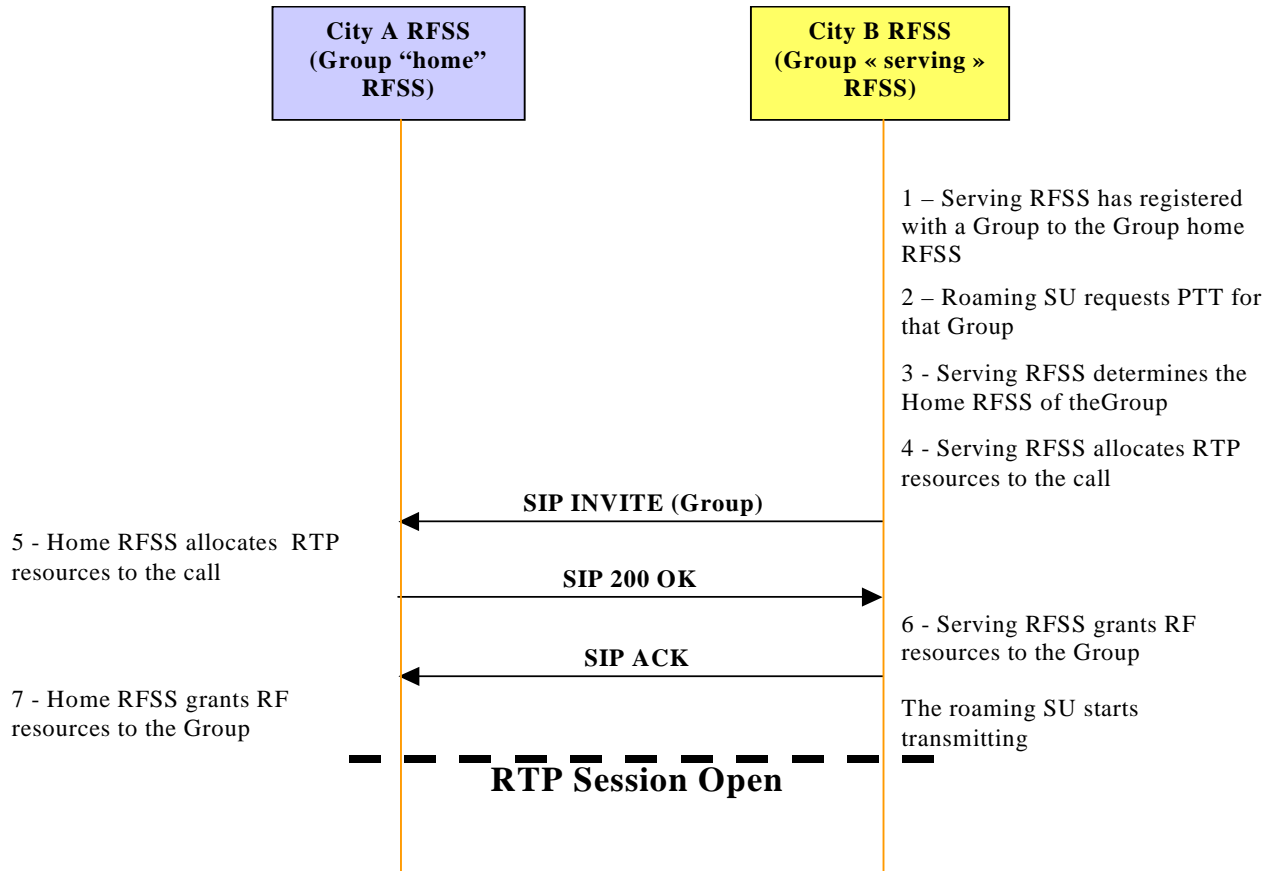

The roaming unit is now able to participate in the Group call.

Group registration, group call setup and PTT among non-overlapping networks

Let's consider now that both City A and City B are adjacent to County C. County C owns its P25 VHF radio infrastructure. Coverage of County C (VHF P25 network), City A (700MHz P25 network) and City B (700MHz P25 network) do not overlap. Let's also consider that no Mutual Aid Channel infrastructure has yet been deployed.

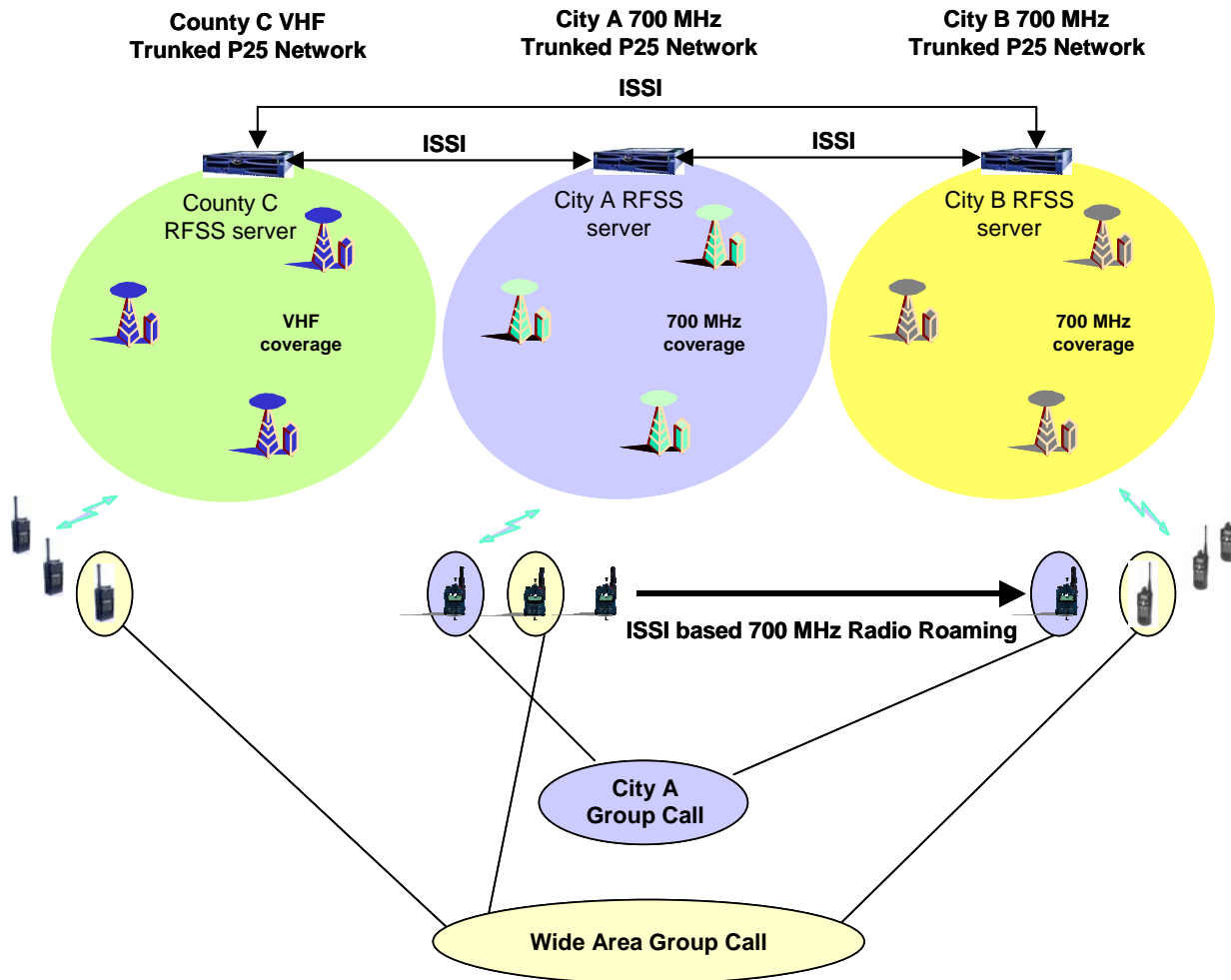

ISSI allows Wide area Group Call between A, B and C with trunking and PTT services

While roaming of radios between County C network and Cities A and B networks is not possible due to the use of different frequency bands, thanks to ISSI, users from County C and Cities A and/or B can share common talk groups. Coordination of these groups can be managed either manually, using the console, or automatically if desired.

Let's assume that one user in each network wants to join a talk group that is managed by City A RFSS. Each user first has to register to this talk group as per the following procedures.

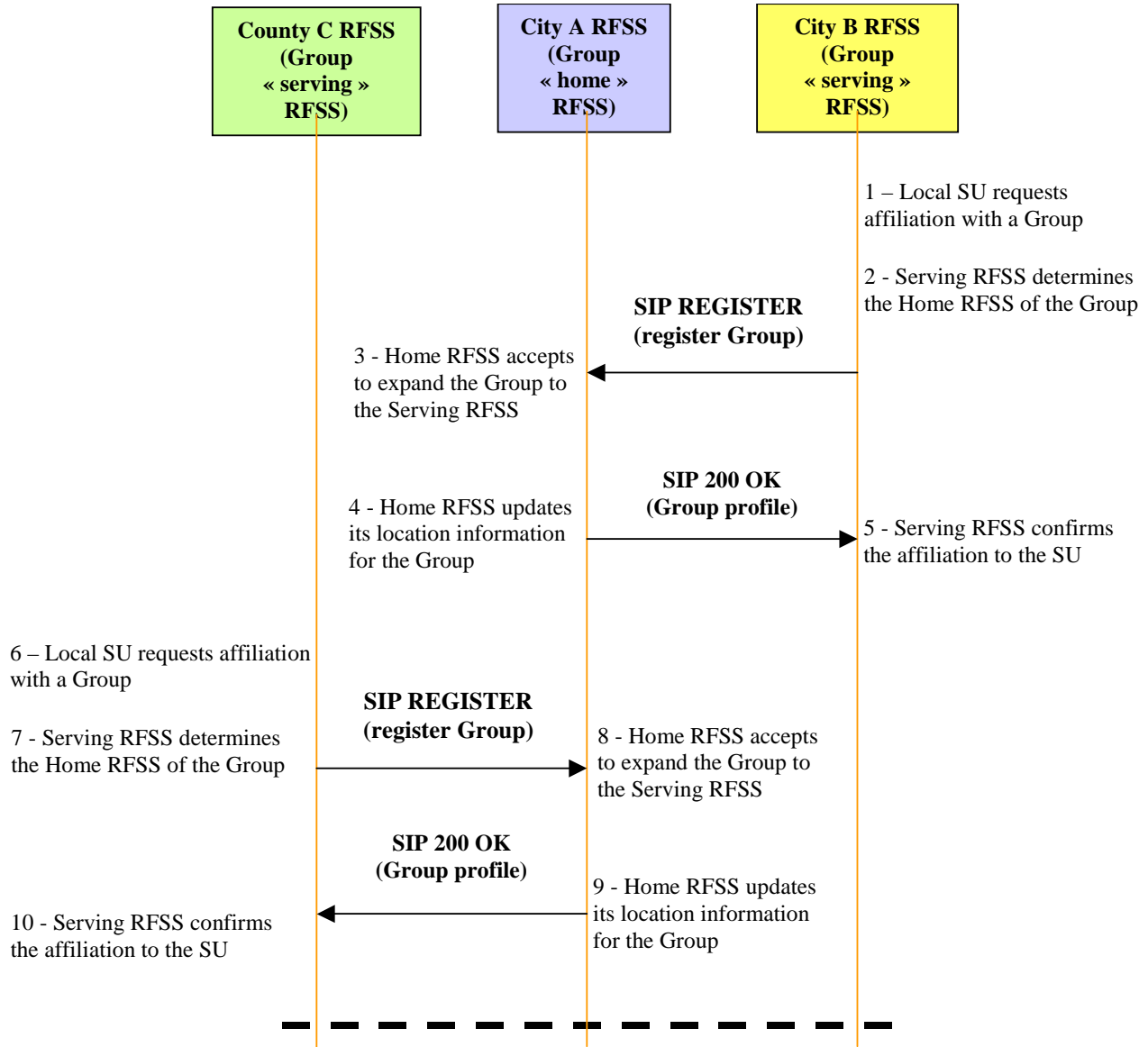

Let's assume that the City B's user initiates the group call and pushes the Talk button. The following procedures are triggered at the ISSI interfaces.

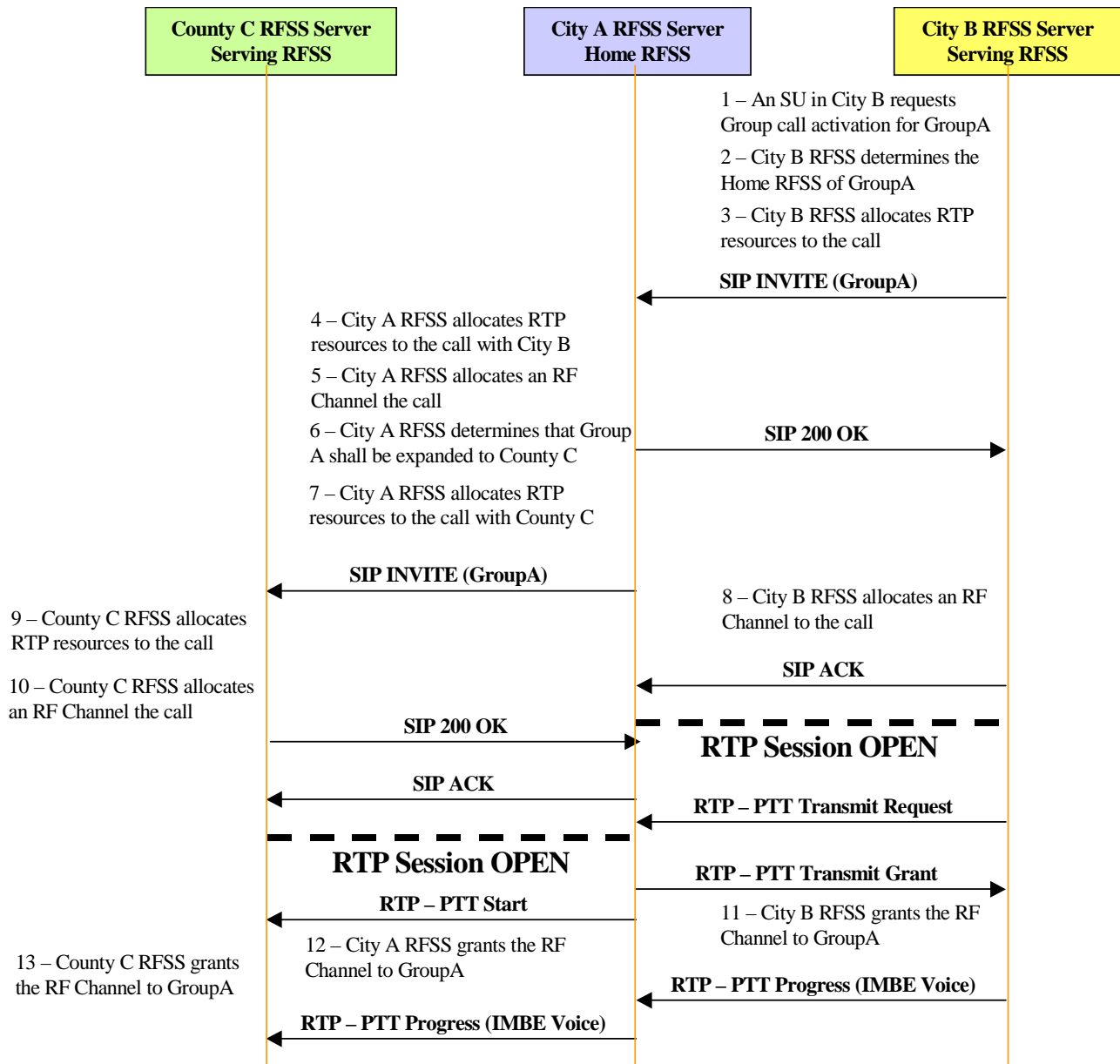

The users under the three non-overlapping networks have been able to register to the same talk group and to use trunking and Push-To-Talk services as if they were under one unique radio network.

Roaming and Group Call Registration between networks from different vendors and frequency band

Let's consider now that City A and County C decided to implement a Mutual Aid Channel (MACH) infrastructure. City A has deployed a VHF based Mutual Aid Channel infrastructure and County C has deployed a 700 MHz Mutual Aid Channel infrastructure.

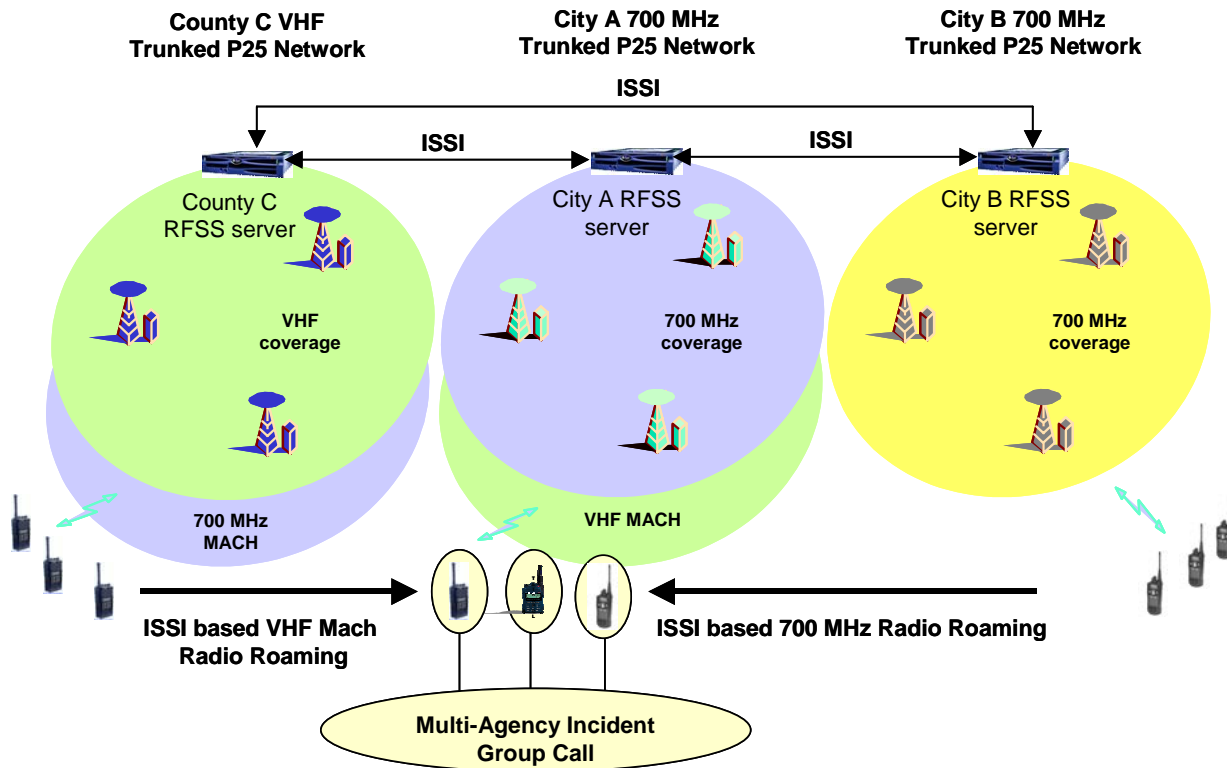

ISSI allows roaming from B and C into A with dynamic registration and access to a common group call

Roaming capability between those different radio networks has now dramatically improved. County C network users can now roam to City A RFSS and vice-versa using the Mutual Channel Infrastructure. Users from City A network and users from City B network can still roam between those two networks. Let's assume that an event happening under City A network coverage requires intervention from City B network users and from County C network users. Users from City B radio network and users from County C radio network will come under City A network coverage and register using the procedures already described.

All the local and roaming users registered under City A network coverage will then be able to join their usual talk groups, controlled by their "home" RFSS and therefore be linked back to their Command and Control Centers. They will also be able to join common talk groups that can be managed and controlled by any of the three RFSS involved.

Conclusions

The examples in this paper are not intended to cover the full spectrum of the ISSI capability. However, they clearly demonstrate that the definition of the P25 ISSI interface provides the means for significant improvements in inter-agency interoperability. Roaming (mobility) of subscriber radios between networks and support for dynamic, transparent and fully featured (including PTT and trunking), individual and group calls across network boundaries are the key benefits provided by the ISSI to the Public Safety community.

The architectural concepts on which the ISSI relies will allow inter-working of Public Safety networks while protecting the freedom for each agency to control and choose the network solution that best fits their specific environment. While a complete migration to such architecture will take time, the sooner ISSI architectural concepts are implemented in Public Safety Radio Networks, the quicker this migration will occur and bring its benefits to the Public Safety community. We encourage that all new system purchases should require the ISSI interface and that existing systems explore the implementation of an ISSI gateway for connectivity to new systems.