

TM 11-5543

DEPARTMENT OF THE ARMY TECHNICAL MANUAL

R A D I A C S E T AN/PDR-27 (*)

This reprint includes all changes in effect at the time of publication - Changes 1, 4, 5, and 6.

DEPARTMENT OF THE ARMY • AUGUST 1952

TECHNICAL MANUAL
RADIAC SETS AN/PDR-27A, -27C, AND -27E

TM 11-5543 }
 CHANGES No. 1 }

DEPARTMENT OF THE ARMY
 WASHINGTON 25, D. C., 3 February 1955

TM 11-5543, 22 August 1952, is changed as follows:

The title of the manual is changed to read:

RADIAC SETS AN/PDR-27A, -27C, AND -27E

Section 1. GENERAL DESCRIPTION

Note. (Added) Radiac Sets AN/PDR-27C and -27E are similar to Radiac Set AN/PDR-27A. The information covering Radiac Set AN/PDR-27A also applies to Radiac Sets AN/PDR-27C and -27E. For example, information concerning Radiacmeter IM-63/PDR-27A (Radiac Set AN/PDR-27A) applies equally to Radiacmeter IM-74/PDR-27C (Radiac Set AN/PDR-27C) and Radiacmeter IM-74A/PDR-27C (Radiac Set AN/PDR-27E). Where differences exist between models, they are specifically mentioned under each applicable paragraph. Basic differences are listed in table 1-4. Official nomenclature followed by (*) is used to denote all models of the equipment covered in this manual. Thus, Radiac Set AN/PDR-27(*) represents Radiac Sets AN/PDR-27A, -27C, and -27E.

1.1. Forms and Records

(Added)

The following forms will be used for reporting unsatisfactory conditions of Army materiel and equipment.

a. DD Form 6, Report of Damaged or Improper Shipment, will be filled out and forwarded as prescribed in SR 745-45-5 (Army), Navy Shipping Guide, Article 1850-4 (Navy); and AFR 71-4 (Air Force)

b. DA Form 468, Unsatisfactory Equipment Report will be filled out and forwarded to the Office of the Chief Signal Officer as prescribed in SR 700-45-5.

c. DD Form 535, Unsatisfactory Report, will be filled out and forwarded as prescribed in SR 700-45-5 and TO 00-35D-54.

d. DA Form 11-238, Operator First Echelon Maintenance Check List for Signal Corps Equipment, Radio Communication, Direction Finding, Carrier, Radar, will be prepared in accordance with instructions on the back of the form (fig. 6-1).

e. DA Form 11-239, Second and Third Echelon Maintenance Check List for Signal Corps Equipment, Radio Communication, Direction Finding, Carrier, Radar, will be prepared in accordance with instructions on the back of the form (fig. 6-2).

f. Use other forms and records as authorized.

2. Description of Units

(See tables 1-1, 1-1.1, 1-1.2, and 1-2.)

Radiac Set AN/PDR-27A consists of the components listed in tables 1-1 and 1-2. Radiac Set AN/PDR-27C consists of the components listed in tables 1-1.1 and 1-2. Radiac Set AN/PDR-27E consists of the components listed in tables 1-1.2 and 1-2.

* * * * *

The title of table 1-1 is changed to read:

Table 1-1. Equipment Supplied **With Radiac Set AN/PDR-27A.**

Table 1-1.1. Equipment Supplied With Radiac Set AN/PDR-27C
(Added)

Quantity per equipment	Name of unit	Navy type designation	Overall dimensions			Volume	Weight
			Height	Width	Length		
1	Case	CY-963A/PDR-27A	9 $\frac{21}{32}$	11 $\frac{1}{2}$	16 $\frac{3}{16}$	1797.1	7.5
1	Radiacmeter	IM-74/PDR-27C	8	5 $\frac{7}{8}$	12 $\frac{1}{2}$	787.5	10
1	Radiac Detector	DT-53B/PDR-27	1 $\frac{3}{8}$ dia		7 $\frac{13}{16}$	11.5	.87
1	Headset	H-43/U	2 $\frac{1}{8}$	7	6 $\frac{1}{8}$	91.3	.87
1	Harness	ST-119/PDR-27					1.12
1	Radioactive Test Sample.	MX-1083B/PDR-27	$\frac{3}{8}$ dia		5	.55	.03
1	Wrench, special	H-301	$\frac{1}{16}$	1	4	.25	.06
1	Wrench, Allen	H-302	$\frac{5}{64}$	$\frac{45}{64}$	$\frac{61}{64}$.60	.01
2	Instruction books for Radiac Set AN/PDR-27C.		$\frac{1}{4}$	5 $\frac{1}{2}$	7 $\frac{1}{2}$	20.6	1.00
1	Tube (spare)	BS-101	$\frac{1}{4}$ dia		2 $\frac{3}{4}$.04
1	Tube (spare)	BS-1	1 $\frac{1}{4}$ dia		7		.17
1	Tube (spare)	BS-2	$\frac{3}{8}$ dia		4		.02

Note. Dimensions are in inches, volume in cubic inches, and weight in pounds.

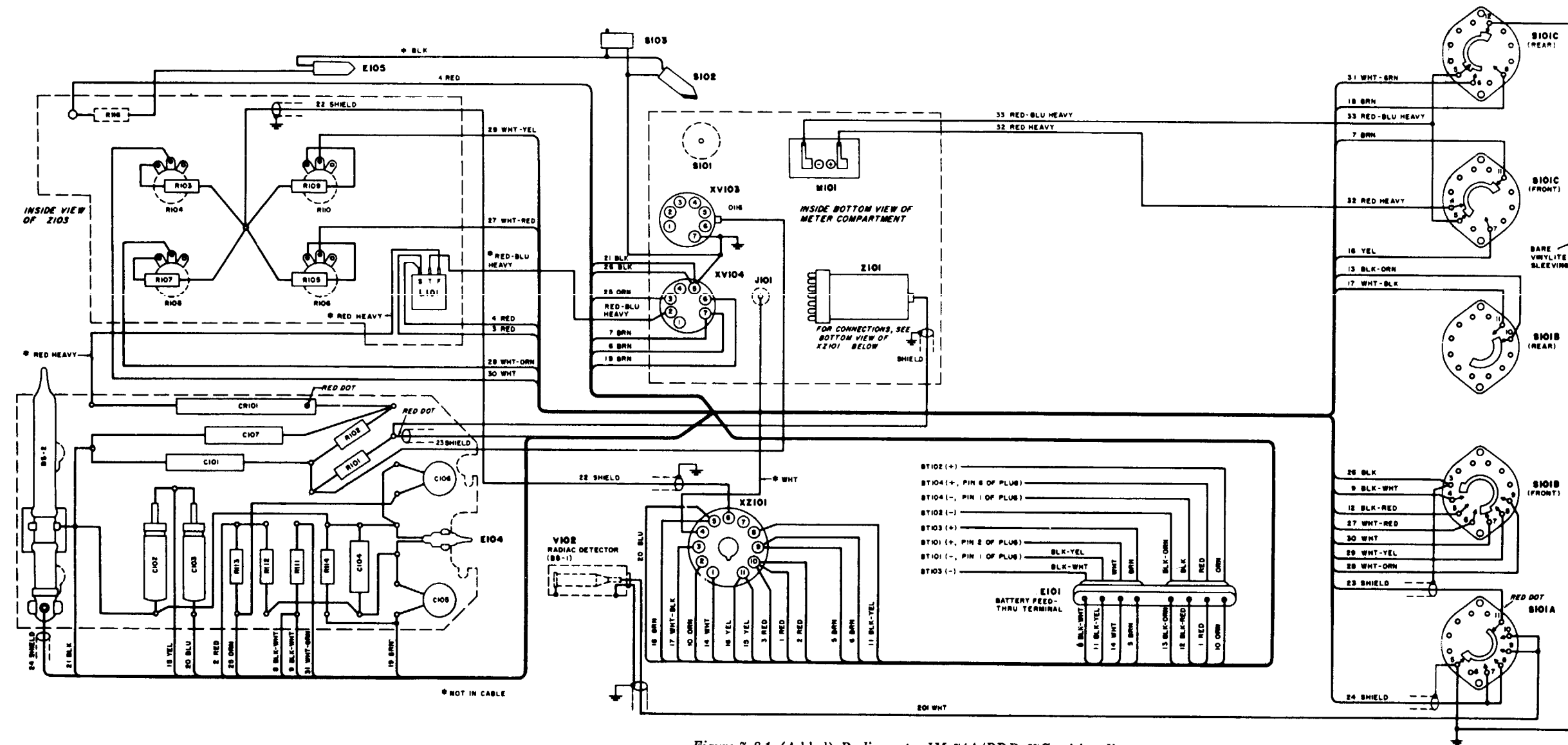

WIRE RUNNING LIST AND COLOR CODE				
WIRE NO.	FROM	TO	COLOR	
1	XZ101-10	BT104 (+)	RED	
2	XZ101-10	R113	RED	
3	XZ101-10	L101-S	RED	
4	R116	L101-S	RED	
5	XZ101-9	BT103 (+)	BRN	
6	XZ101-9	XV104-7	BRN	
7	XV104-7	S101C (FRONT)	BRN	
8	R111	BT103 (+)	BLK-WHT	
9	R111	S101B (FRONT)	BLK-WHT	
10	XZ101-2	BT102 (+)	ORN	
11	XZ101-2	BT101 (-)	BLK-YEL	
12	BT104 (-)	S101B (FRONT)	BLK-RED	
13	BT102 (-)	S101B (REAR)	BLK-ORN	
14	XZ101-1	BT101 (+)	WHT	
15	XZ101-11	C102, C103	YEL	
16	XZ101-11	S101C (FRONT)	YEL	
17	XZ101-3	S101B (REAR)	WHT-BLK	
18	XZ101-5	S101C (REAR)	BRN	
19	C108	XV104-8	BRN	
20	XZ101-5	C103	BLU	
21	XV104-8	BS-E, C101	BLK	
22	XZ101-8	R108	SHIELD	
23	S101A	R101	SHIELD	
24	BS-E	S101A	SHIELD	
25	XV104-3	R113	ORN	
26	XV104-6	S101B (FRONT)	BLK	
27	R108	S101B (FRONT)	WHT-RED	
28	R108	S101B (FRONT)	WHT-ORN	
29	R10	S101B (FRONT)	WHT-YEL	
30	R104	S101C (FRONT)	WHT	
31	R111	S101C (REAR)	WHT-BRN	
32	M101 (+)	S101C (FRONT)	RED HEAVY	
33	M101 (-)	S101C (REAR)	RED-BLU HEAVY	
	XV104-2	L101-T	RED-BLU HEAVY	
	C101	L101-F	RED HEAVY	

COLOR CODING ABBREVIATIONS:

- BLK - BLACK
- BLU - BLUE
- BRN - BROWN
- GRN - GREEN
- ORN - ORANGE
- RED - RED
- YEL - YELLOW
- WHT - WHITE
- HEAVY - HEAVY WIRE

Figure 7-8.1. (Added) Radiometer IM-74A/PDR-27C, wiring diagram.

Table 1-1.2. Equipment Supplied With Radiac Set AN/PDR-27E
(Added)

Quantity per equipment	Name of unit	Navy type designation	Overall dimensions			Volume	Weight
			Height	Width	Length		
1	Case	CY-963B/PDR-27A	9 ²¹ / ₃₂	11 ¹ / ₂	16 ³ / ₁₆	1797.1	8.62
1	Radiacmeter	IM-74A/PDR-27C	7 ³ / ₄	5 ⁷ / ₈	12 ¹ / ₄	787.5	8.88
1	Radiac Detector	DT-53D/PDR-27	1 ³ / ₈ dia		7 ¹³ / ₃₂	11.5	1.0
1	Headset	H-43/U	2 ¹ / ₈	7	6 ¹ / ₈	91.3	.87
1	Harness	ST-125/PDR-27E					1.12
1	Radioactive Test Sample	MX-1083B/PDR-27	3 ³ / ₈ dia		5	.55	.03
1	Wrench, special		1 ¹ / ₁₆	1	4	.25	.11
1	Wrench, Allen		5 ⁵ / ₆₄	4 ⁴⁵ / ₆₄	6 ¹ / ₆₄	.60	.01
2	Instruction Books for Radiac Set AN/PDR-27E.		1 ¹ / ₄	5 ¹ / ₂	7 ¹ / ₂	20.6	1.00
1	Tube (spare)	BS-101	1 ¹ / ₄ dia		2 ³ / ₄		.04
1	Tube (spare)	BS-1	1 ¹ / ₄ dia		7		.17
1	Tube (spare)	BS-2	3 ³ / ₈ dia		4		.02

Note. Dimensions are in inches, volume in cubic inches, and weight in pounds.

The title of table 1-2 is changed to read:

Table 1-2. Equipment Required But Not Supplied With Radiac Sets AN/PDR-27A, -27C, and -27E.

Table 1-3. Shipping Data

Shipping box No.	Contents		Overall dimensions			Volume	Weight*
	Name	Designation	Height	Width	Depth		
*	*		*	*	*	*	*
1	Radiac Set	AN/PDR-27C	14 ¹ / ₂	16	32	4.3	66
1	Radiac Set	AN/PDR-27E	14 ³ / ₄	21 ¹ / ₄	28 ¹ / ₂	5.2	66

Note. Dimensions are in inches, volume in cubic feet, weight in pounds.

*Without batteries.

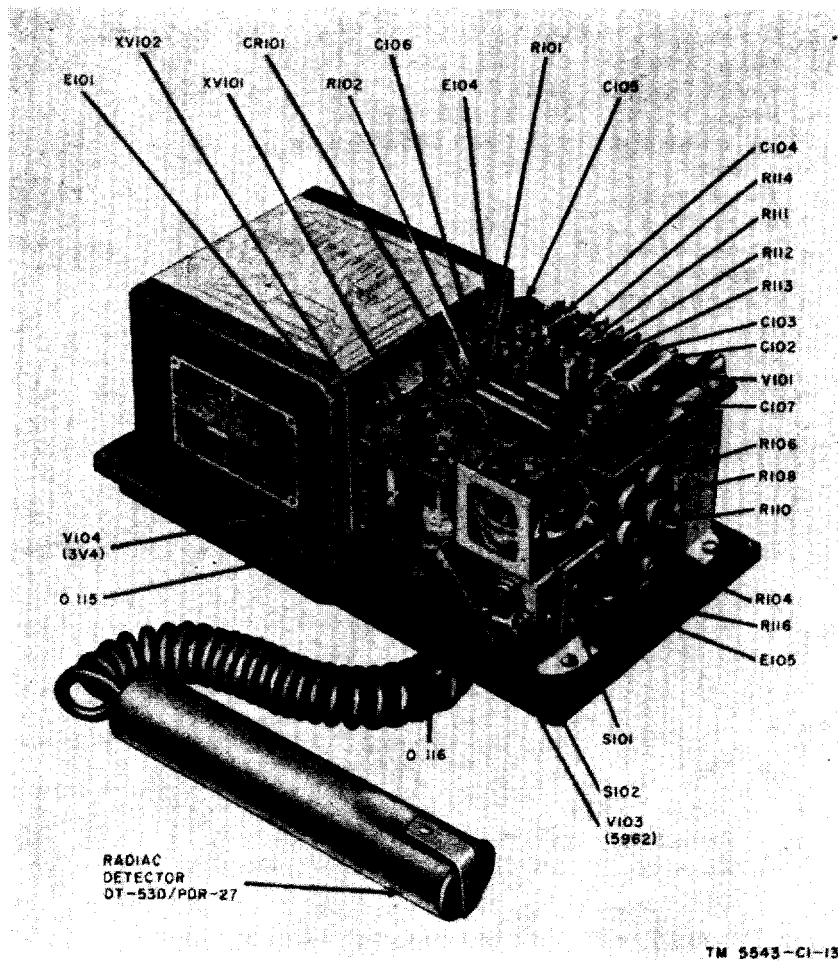

Figure 1-4.1. (Added) Radiometer IM-74A/PDR-27C, inside view.

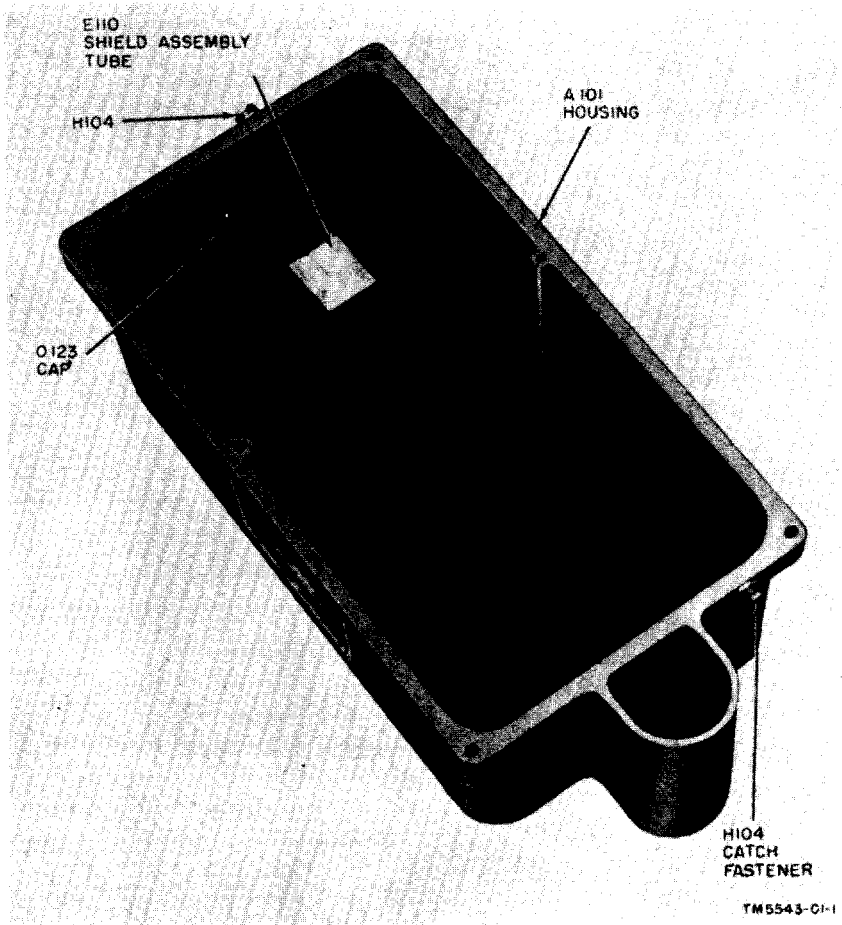

Figure 1-5. (Added) Radiometer IM-74A/PDR-27C waterproof housing with shield assembly.

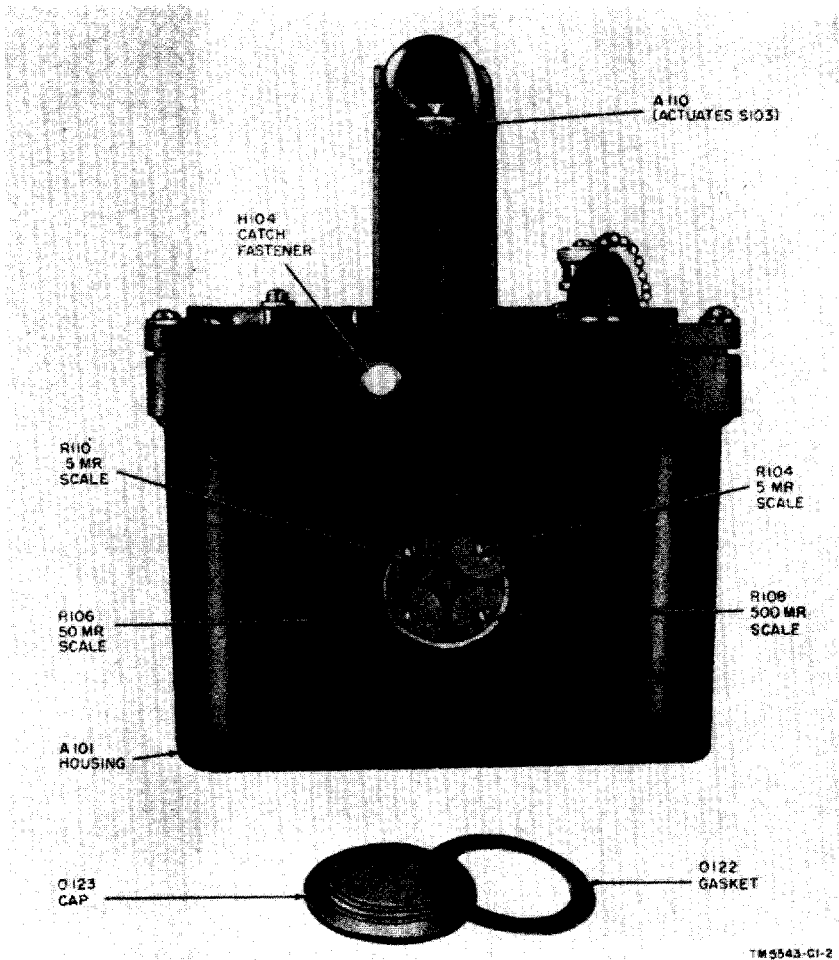

Figure 1-6. (Added) Radiacmeter IM-74A/PDR-27C, showing calibration port and switch actuating assembly.



Figure 1-7. (Added) Switch actuating assembly, exploded view.

Table 1-4. Equipment Similarities
(Added)

Item differences	Radiac Set AN/PDR-27A	Radiac Set AN/PDR-27C	Radiac Set AN/PDR-27E
Batteries required	1 JAN type BA-416/U 1 JAN type BA-413/U 2 JAN type BA-401/U	Same as AN/PDR-27A	Same as AN/PDR-27A
Trigger amplifier	Ref Symbol Z 101 ^a Kelley Koett part/dwg no. IDC-4879 Sig. C stock No. 3M1-63	Ref Symbol Z 101 ^a Admiral part/dwg no. GB-162 Sig. C stock No. 3MC7-3	Ref Symbol Z 101 ^a Admiral part/dwg no. GC-329 Sig. C stock No. 3MC7-10
Dial lamp	Turned on by tilting radiacmeter	Turned on by tilting radiacmeter	Turned on by tilting radiacmeter or by using panel push button (fig. 1-7)
Calibration port	None	None	Has calibration port (fig. 1-6)
High voltage power supply	Uses reactor L101	Uses reactor L101	Uses autotransformer L101
Radiacmeter	IM-63/PDR-27A	IM-74/PDR-27C Has lead shields over geiger tubes ^b	IM-74A/PDR-27C Has lead shields over geiger tubes ^b (fig. 1-4.1)
Radiac detector	DT-53/PDR-27 cable entrance on side	DT-53B/PDR-27 cable entrance on side	DT-53D/PDR-27 cable entrance on end
Carrying case	CY-963/PDR-27A waterproof	CY-963A/PDR-27A waterproof	CY-963B/PDR-27A waterproof
Harness	ST-119/PDR-27	Same as AN/PDR-27A	ST-125/PDR-27E
Radioactive test sample	MX-1083/PDR-27 Uses equivalent of 5 microcuries of cobalt 60	MX-1083B/PDR-27 Uses radium source 7 micrograms	Same as AN/PDR-27C
Navy contract number and date	NObsr-49282 1950	NObsr-52222 January 1951	NObsr-57097 December 1951
Contractor	Kelley-Koett Instrument Co.	Admiral Corporation	Admiral Corporation

^a Units are interchangeable.

^b See figures 1-5 and 7-6.1.

Section 2. THEORY OF OPERATION

3. Circuit Analysis

Note. (Added) Circuit component differences in models are shown in table 7-5.

* * * * *

b. *Pulse Shaper and Amplifier Circuit* (fig. 2-4). The pulse shaper * * * to its plate. The control grid of V-106 is connected via one of the resistance paths, through **S101B (front)** to ground. The cathode of * * * Cathode resistor R-120. Capacitor C-111 now discharges through the selected resistance path and **S101B (front)** to ground. Tube V-106 conducts * * * and indicating circuit. The duration of the V-106 output pulses is determined primarily by the time constant of the selected coupling circuit, and is thus constant for any particular range; each range has a different time constant because the grid-to-ground resistance of V-106 is changed by **S101B (front)** whenever ranges are changed. Consequently, the duration * * * the radiation intensity.

c. *Integrating and Indicating Circuit* (fig. 2-5). The integrating and * * * M-101 and R-121. **In Radiac Sets AN/PDR-27E, capacitor C103 is connected in parallel with meter M101 only.** Capacitor C-103 resistor * * * indicate mr/hr directly.

* * * * *

e. *Filament Power Supply Circuit* (fig. 7-7). Battery BT-102 provides * * * of the battery.

f. *High-voltage Power Supply Circuit* (fig. 2-7 or 2-7.1). The high voltage * * * a regulating circuit.

* * * * *

h. *Meter Illumination Circuit* (fig. 2-8). The meter illumination * * * its operating value.

Note. (Added) In Radiac Set AN/PDR-27E, a mercury (tilt) switch and a push-button switch are placed in parallel (fig. 7-7.1). During operation, either switch may be used to turn on the meter illumination.

The legend of figure 2-7 is changed to read:

Figure 2-7. High power supply circuit **for Radiac Sets AN/PDR-27A and -27C.**

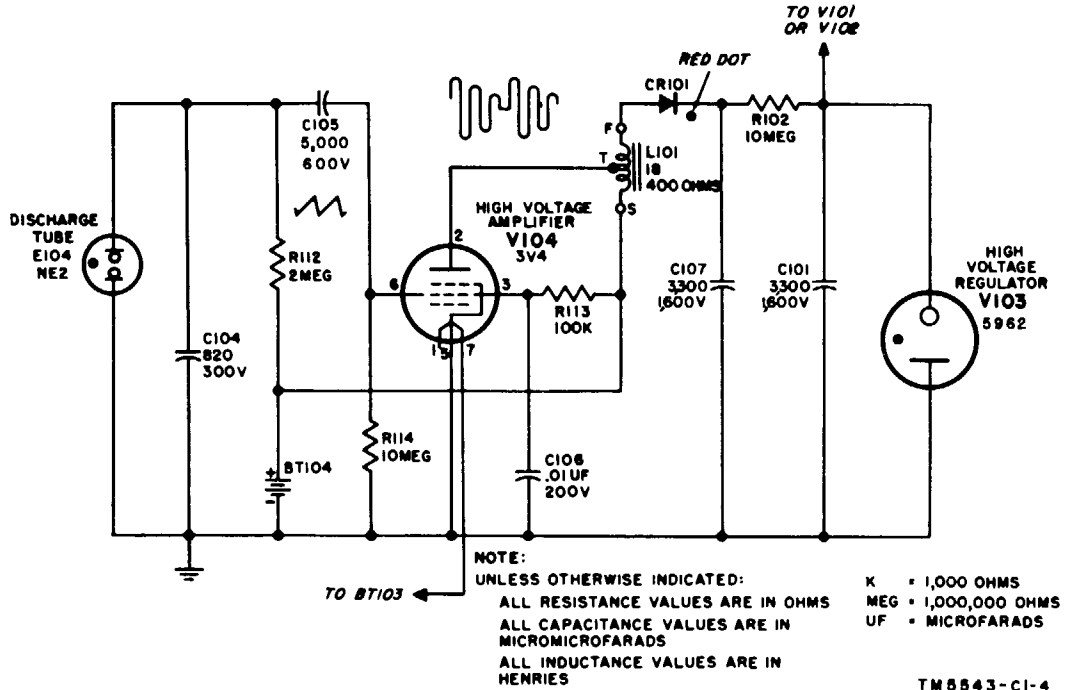

Figure 2-7.1. (Added) High-voltage power supply circuit for Radiac Set AN/PDR-27E.

Section 3. INSTALLATION

3. Initial Testing

(See fig. 3-3 or 3-3.1.)

Test the radiac * * * the following steps:

Note. (Added) When performing steps 5 through 8, use figure 3-3 with Radiac Set AN/PDR-27A and figure 3-3.1 with Radiac Sets AN/PDR-27C, and -27E. Meter readings of steps 5 through 8 for Radiac Set AN/PDR-27A are given in the text; meter readings for the two other models are given in table 3-1.

* * * * *

Step 4. Remove the radioactive test sample from the carrying case.

Note. (Added) A dimple is provided on the bottom surface of the radiacmeter housing of Radiac Sets AN/PDR-27C and -27E. When the active end of the radioactive test sample is placed in this dimple, maximum meter deflection is obtained.

* * * * *

The legend of figure 3-3 is changed to read:

Figure 3-3. Radiacmeter Test Set-up for Radiac Set AN/PDR-27A.

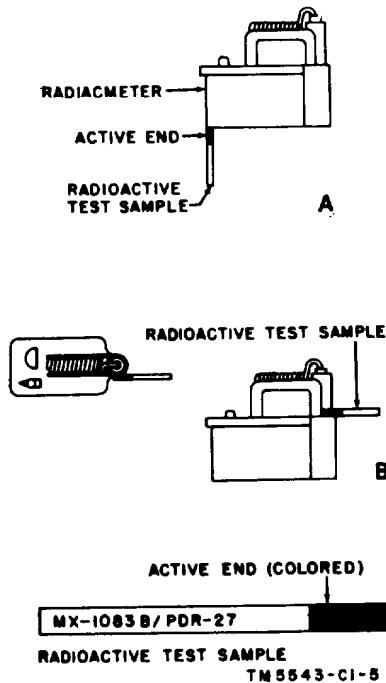

Figure 3-3.1. (Added) Radiacmeter test set-up for Radiac Sets AN/PDR-27C and -27E.

Table 3-1. Initial Test Meter Readings for All Models Except Radiac Set AN/PDR-27A
(Added)

Step	5	6	7	8
Range switch setting	500	50	5	.5
Meter reading milliroentgen hour	10-30	5-15	1-3	.1-0.3

Section 4. OPERATION

6. Operation Under Unusual Conditions

(Added)

The operation of Radiac Set AN/PDR-27(*) may be difficult in regions where extreme cold, heat, humidity and moisture, sand conditions, etc., prevail. Instructions on procedures for minimizing the effect of these unusual operating conditions are given in *a* through *c* below.

a. Operation in Arctic Climates. Subzero temperatures and climatic conditions associated with cold weather adversely affect the efficient operation of the equipment. Instructions and precautions for operation under such adverse conditions follow:

- (1) Handle the equipment carefully.
- (2) Keep the equipment warm and dry. If necessary, construct an insulated box for the set.
- (3) Allow at least 1 minute for the tubes to warm up.
- (4) When equipment that has been exposed to the cold is brought into a warm room, it will sweat until it reaches room temperature. When the equipment has reached room temperature, dry it thoroughly. This condition also arises when equipment warms up during the day after exposure during a cold night.
- (5) Use any improvised means to protect the dry batteries, because they will fail if not protected against the cold. If necessary, preheat the batteries. Store spare batteries in bags lined with kapok, spun glass, fiber materials, animal skins, or woolen clothing.

b. Operation in Tropical Climates. When operated in tropical climates, this equipment might be used in swampy areas where moisture conditions are more acute than normal. The high relative humidity causes condensation of moisture on the equipment whenever the temperature of the equipment becomes lower than that of the ambient air. To prevent moisture seeping into the set, make sure that all the mounting screws are tight on the front panel and battery compartment cover.

c. Operation in Desert Climates. Conditions similar to those encountered in tropical climates often prevail in desert areas. The main problem that arises, however, is the large amount of sand or dirt which may enter the equipment. Keep the equipment as clean as possible.

Section 6. PREVENTIVE MAINTENANCE

1.1. General Preventive Maintenance Techniques

(Added)

- a. Use No. 000 sandpaper to remove corrosion.
- b. Use a clean, dry, lint-free cloth or a dry brush for cleaning.
 - (1) If necessary, except for electrical contacts, moisten the cloth or brush with cleaning compound; then wipe the parts dry with a cloth.
 - (2) Clean electrical contacts with a cloth moistened with carbon tetrachloride; then wipe them dry with a dry cloth.

Caution: Repeated contact of carbon tetrachloride with the skin or prolonged breathing of the fumes is dangerous. Make sure adequate ventilation is provided.

c. If available, dry compressed air may be used at a line pressure not exceeding 60 pounds per square inch to remove dust from inaccessible places; be careful, however, of mechanical damage from the air blast may result.

d. For further information on preventive maintenance techniques, refer to TB SIG 178.

2. Use of Preventive Maintenance Forms

(figs. 6-1 and 6-2)

(Superseded)

a. The decision as to which items on DA Forms 11-238 and 11-239 are applicable to this equipment is a tactical decision to be made in the case of first echelon maintenance by the communication officer/chief or his designated representative, and in the case of second and third echelon maintenance, by the individual making the inspection. Instructions for the use of each form appear on the reverse side of the form.

b. Circled items in figures 6-1 and 6-2 are partially or totally applicable to Radiac Set AN/PDR-27(*). References in the ITEM block refer to paragraphs in text which contain additional maintenance information.

OPERATOR FIRST ECHELON MAINTENANCE CHECK LIST FOR SIGNAL CORPS EQUIPMENT									
RADIO COMMUNICATION, DIRECTION FINDING, CARRIED, RADAR									
INSTRUCTIONS: See other side									
EQUIPMENT NOMENCLATURE					EQUIPMENT SERIAL NO.				
LEGEND FOR MARKING CONDITIONS: ✓ Satisfactory; X Adjustment, repair or replacement required; ① Defect corrected.									
NOTE: Strike out items not applicable.									
DAILY									
NO.	ITEM	CONDITION							
		S	M	T	W	T	F	S	
1	COMPLETENESS AND GENERAL CONDITION OF EQUIPMENT (receiver, transmitter, carrying case, wire and cable, microphone, tubes, spare parts, technical manuals and accessories). PAR. E.10								
2	LOCATION AND INSTALLATION SUITABLE FOR NORMAL OPERATION.								
3	CLEAN DIRT AND MOISTURE FROM ANTENNA, MICROPHONE, HEADSETS, CHESTSETS, KEYS, JACKS, PLUGS, TELEPHONES, CARRYING BAGS, COMPONENT PANELS. PAR. E.10								
4	INSPECT SEATING OF READILY ACCESSIBLE "PLUG-OUT" ITEMS: TUBES, LAMPS, CRYSTALS, PIPES, CONNECTORS, VIBRATORS, PLUG-IN COILS AND RESISTORS. PAR. E.10								
5	INSPECT CONTROLS FOR BINDING, SCRAPING, EXCESSIVE LOOSENESS, WORN OR CHIPPED GEARS, MISALIGNMENT, POSITIVE ACTION. PAR. E.10								
6	CHECK FOR NORMAL OPERATION. PAR. E.10								
WEEKLY									
NO.	ITEM	I C O N D I T I O N	NO.	ITEM	I C O N D I T I O N				
7	CLEAN AND TIGHTEN EXTERIOR OF COMPONENTS AND CASES, RACK MOUNTS, SHOCK MOUNTS, ANTENNA MOUNTS, COAXIAL TRANSMISSION LINES, WAVE GUIDES, AND CABLE CONNECTIONS. PAR. E.10		13	INSPECT STORAGE BATTERIES FOR DIRT, LOOSE TERMINALS, ELECTROLYTE LEVEL AND SPECIFIC GRAVITY, AND DAMAGED CASES.					
8	INSPECT CASES, MOUNTINGS, ANTENNAS, TOWERS, AND EXPOSED METAL SURFACES, FOR RUST, CORROSION, AND MOISTURE. PAR. E.10		14	CLEAN AIR FILTERS, BRASS NAME PLATES, DIAL AND METER WINDOWS, JEWEL ASSEMBLIES.					
9	INSPECT CORD, CABLE, WIRE, AND SHOCK MOUNTS FOR CUTS, BREAKS, FRAYING, DETERIORATION, KINKS, AND STRAIN. PAR. E.10		15	INSPECT METERS FOR DAMAGED GLASS AND CASES. PAR. E.10					
10	INSPECT ANTENNA FOR ECCENTRICITIES, CORROSION, LOOSE FIT, DAMAGED INSULATORS AND REFLECTORS.		16	INSPECT SHELTERS AND COVERS FOR ADEQUACY OF WEATHER-PROOFING.					
11	INSPECT CANVAS ITEMS, LEATHER, AND CABLEING FOR MILDEN, TEARS, AND FRAYING. PAR. E.10		17	CHECK ANTENNA GUY WIRES FOR LOOSENESS AND PROPER TENSION.					
12	INSPECT FOR LOOSENESS OF ACCESSIBLE ITEMS: SWITCHES, HOODS, JACKS, CONNECTORS, ELECTRICAL TRANSFORMERS, POWER-STATS, RELAYS, SELECTORS, MOTORS, BLOWERS, CAPACITORS, GENERATORS, AND PILOT LIGHT ASSEMBLIES. PAR. E.10		18	CHECK TERMINAL BOX COVERS FOR CRACKS, LEAKS, DAMAGED GASKETS, DIRT AND GREASE.					
19	IF DEFICIENCIES NOTED ARE NOT CORRECTED DURING INSPECTION, INDICATE ACTION TAKEN FOR CORRECTION.				PAR. E.10				

DA FORM 11-238
1 MAY 51

REPLACES DA AGO FORM 419, 1 DEC 50, WHICH IS OBSOLETE.

TM5543-CI-11

Figure 6-1. (Added) DA Form 11-238.

SECOND AND THIRD ECHELON MAINTENANCE CHECK LIST FOR SIGNAL CORPS EQUIPMENT			
RADIO COMMUNICATION, DIRECTION FINDING, CARRIER, RADAR			
INSTRUCTIONS: See other aids			
EQUIPMENT NOMENCLATURE		EQUIPMENT SERIAL NO.	
LEGEND FOR MARKING CONDITIONS: ✓ Satisfactory; X Adjustment, repair or replacement required; ① Defect corrected. NOTE: Strike out items not applicable.			
NO.	ITEM	NO.	ITEM
1	COMPLETENESS AND GENERAL CONDITION OF EQUIPMENT (receiver, transmitter, carrying frame, wire and cable, microphone, tubes, spare parts, technical manual and accessories). PAR. E.10	15	ELECTRON TUBES - INSPECT FOR LOOSE ENVELOPES, CAP CONNECTIONS, CRACKED SOCKETS; INSUFFICIENT SOCKET SPRING TENSION; CLEAN DUST AND DIRT CAREFULLY; CHECK EMISSION OF RECEIVER TYPE TUBES. PAR. E.11
2	LOCATION AND INSTALLATION SUITABLE FOR NORMAL OPERATION.	20	INSPECT FIRM CUT-OUTS FOR LOOSE PARTS, DIRT, MISALIGNMENT AND CORROSION.
3	CLEAN DIRT AND MOISTURE FROM ANTENNA, MICROPHONE, HEADSETS, CHESTSETS, KEYS, JACKS, PLUGS, TELEPHONES, CARRYING BAGS, COMPONENT PANELS. PAR. E.1b	21	INSPECT FIXED CAPACITORS FOR LEAKS, BULGES, AND DISCOLORATION.
4	INSPECT SEATING OF READILY ACCESSIBLE "PLUCK-OUT" ITEMS: TUBES, LAMPS, CRYSTALS, FUSES, CONNECTORS, VIBRATORS, PLUG-IN COILS AND RESISTORS. PAR. E.1c	22	INSPECT RELAY AND CIRCUIT BREAKER ASSEMBLIES FOR LOOSE MOUNTINGS; BURNED, PITTED, CORRODED CONTACTS; MISALIGNMENT OF CONTACTS AND SPRINGS; INSUFFICIENT SPRING TENSION; BINDING OF PLUNGERS AND RINGE PARTS.
5	INSPECT CONTROLS FOR BINDING, SCRAPING, EXCESSIVE LOOSENESS, WORK OF CHIPPED GEARS, MISALIGNMENT, POSITIVE ACTION. PAR. E.1d	23	INSPECT VARIABLE CAPACITORS FOR DIRT, MOISTURE, MISALIGNMENT OF PLATES, AND LOOSE MOUNTINGS.
6	CHECK FOR NORMAL OPERATION. PAR. E.1e	24	INSPECT RESISTORS, BUSHINGS, AND INSULATORS, FOR CRACKS, CHIPPING, BLISTERING, DISCOLORATION AND MOISTURE. PAR. E.1m
7	CLEAN AND TIGHTEN EXTERIOR OF COMPONENTS AND CASES, RACK MOUNTS, SHOCK MOUNTS, ANTENNA MOUNTS, COAXIAL TRANSMISSION LINES, WAVE GUIDES, AND CABLE CONNECTIONS. PAR. E.1f	25	INSPECT TERMINALS OF LARGE FIXED CAPACITORS AND RESISTORS FOR CORROSION, DIRT AND LOOSE CONTACTS.
8	INSPECT CASES, MOUNTINGS, ANTENNAS, TOWERS, AND EXPOSED METAL SURFACES, FOR RUST, CORROSION, AND MOISTURE. PAR. E.1g	26	CLEAN AND TIGHTEN SWITCHES, TERMINAL BLOCKS, BLOWERS, RELAY CASES, AND INTERIORS OF CHASSIS AND CABINETS NOT READILY ACCESSIBLE. PAR. E.1n
9	INSPECT CORD, CABLE, WIRE, AND SHOCK MOUNTS FOR CUTS, BREAKS, FRAYING, DETERIORATION, KINKS, AND STRAIN. PAR. E.1h	27	INSPECT TERMINAL BLOCKS FOR LOOSE CONNECTIONS, CRACKS AND BREAKS.
10	INSPECT ANTENNA FOR ECCENTRICITIES, CORROSION, LOOSE FIT, DAMAGED INSULATORS AND REFLECTORS.	28	CHECK SETTINGS OF ADJUSTABLE RELAYS.
11	INSPECT CANVAS ITEMS, LEATHER, AND CABLING FOR MILDREW, TEARS, AND FRAYING. PAR. E.1j	29	LUBRICATE EQUIPMENT IN ACCORDANCE WITH APPLICABLE DEPARTMENT OF THE ARMY LUBRICATION ORDER.
12	INSPECT FOR LOOSENESS OF ACCESSIBLE ITEMS: SWITCHES, KNOBS, JACKS, CONNECTORS, ELECTRICAL TRANSFORMERS, POWERSTATS, RELAYS, SELECTORS, MOTORS, BLOWERS, CAPACITORS, GENERATORS, AND PILOT LIGHT ASSEMBLIES. PAR. E.1j	30	INSPECT GENERATORS, AMPLIFIERS, DYNAMOTORS, FOR BRUSH WEAR, SPRING TENSION, ARCING, AND FITTING OF COMMUTATOR.
13	INSPECT STORAGE BATTERIES FOR DIRT, LOOSE TERMINALS, ELECTROLYTE LEVEL AND SPECIFIC GRAVITY, AND DAMAGED CASES.	31	CLEAN AND TIGHTEN CONNECTIONS AND MOUNTINGS FOR TRANSFORMERS, CHOSES, POTENTIOMETERS, AND RHEOSTATS.
14	CLEAN AIR FILTERS, BRASS NAME PLATES, DIAL AND METER WINDOWS, JEWEL ASSEMBLIES.	32	INSPECT TRANSFORMERS, CHOSES, POTENTIOMETERS, AND RHEOSTATS FOR OVERHEATING AND OIL-LEAKAGE.
15	INSPECT METERS FOR DAMAGED GLASS AND CASES. PAR. E.1k	33	BEFORE SHIPPING OR STORING - REMOVE BATTERIES.
16	INSPECT SHELTERS AND COVERS FOR ADEQUACY OF WEATHERPROOFING.	34	INSPECT CATHODE RAY TUBES FOR BURNED SCREEN SPOTS.
17	CHECK ANTENNA GUY WIRES FOR LOOSENESS AND PROPER TENSION.	35	INSPECT BATTERIES FOR SHORTS AND DEAD CELLS. PAR. E.1p
18	CHECK TERMINAL BOX COVERS FOR CRACKS, LEAKS, DAMAGED BASKETS, DIRT AND GREASE.	36	INSPECT FOR LEAKING WATERPROOF GASKETS, WORK OR LOOSE PARTS.
19	IF DEFICIENCIES NOTED ARE NOT CORRECTED DURING INSPECTION, INDICATE ACTION TAKEN FOR CORRECTION. PAR. E.1b	37	MOISTURE AND FUME-PROOF. PAR. E.1r

DA FORM 11-239
1 MAY 53

REPLACES DA AGO FORM 539, 1 DEC 50, WHICH IS OBSOLETE.

16-10-2463-1

TM5543-C1-12

Figure 6-2. (Added) DA Form 11-239.

2.1. Performing Preventive Maintenance

(Added)

The following preventive maintenance operations should be performed by organizational personnel at the intervals indicated, unless these intervals are reduced by the local commander.

Caution: Screws, nuts, and bolts should not be tightened carelessly. Fittings tightened beyond the pressure for which they are designed will be damaged or broken.

a. Check for completeness and satisfactory condition of Radiac Set AN/PDR-27(*) (sec. 1).

b. Clean the headset, headset jack, probe, probe cable, and front panel.

c. Inspect the seating of V101, V103, V104, E104, E105, and Z101.

d. Inspect the range switch control for binding, excessive looseness, worn or chipped gear and chain, misalignment, and positive action.

e. Check for normal operation as outlined in section 4.

f. Clean and tighten the exterior of the radiac set.

Caution: Never use gasoline as cleaning fluid.

g. Inspect the case, front panel, and carrying handle for rust, corrosion, and moisture.

Caution: Before performing preventive maintenance operations inside the radiac set, disconnect the batteries from the circuit (reverse of procedure outlined in sec. 3).

h. Inspect wiring for cuts, breaks, fraying, deterioration, kinks, and strain.

i. Inspect the carrying harness for tears and fraying.

j. Inspect for looseness of accessible items.

(1) Front panel knob.

(2) Switches S101 and S102.

(3) Mounting of potentiometers R104, R106, R108, and R110.

(4) Sprocket gear and chain.

k. Inspect the meter for damaged glass and case.

l. Inspect tubes V101, V103, V104 and sockets XV101, XV102, and XZ101 for cracked insulation and insufficient socket spring tension. Remove dust and dirt carefully; check emission of V103 and V104.

m. Inspect resistors and insulation for chipping, blistering, discoloration and moisture.

n. Clean and tighten S101 and S102.

- o. Before shipping or storing, remove the batteries.
- p. Inspect all batteries for dead cells, bulging sides, and leaking cases.
- q. Inspect for leaking waterproof gaskets under the control knob around the battery compartment cover, around the front panel, on the inlet of the flexible cable, and on the probe.
- r. Check adequacy of moistureproofing and fungiproofing treatment (pars. 3 and 3.1).
- s. If deficiencies noted are not corrected during the inspection indicate the action taken for correction.

3.1. Weatherproofing

(Added)

a. *General.* Signal Corps equipment, when operated under severe climatic conditions such as prevail in tropical, arctic, and desert regions, requires special treatment and maintenance. Fungus growth, insects, dust, corrosion, salt spray, excessive moisture, and extreme temperatures are harmful to most materials.

b. *Tropical Maintenance.* A special moistureproofing and fungiproofing treatment has been devised which, if properly applied, provides a reasonable degree of protection. This treatment is explained in TB SIG 13 and TB SIG 72.

c. *Winter Maintenance.* Special precautions necessary to prevent poor performance or total operational failure of equipment in extremely low temperatures are explained in TB SIG 66.



d. *Desert Maintenance.* Special precautions necessary to prevent equipment failure in areas subject to extremely high temperatures, low humidity, and excessive sand and dust are explained in TB SIG 75.

e. *Lubrication.* The effects of extreme cold and heat on materials and lubricants are explained in TB SIG 69. Observe all precautions outlined in TB SIG 69 and pay strict attention to all lubrication orders when operating equipment under conditions of extreme cold or heat.

Section 7. CORRECTIVE MAINTENANCE

The legend of figure 7-2 is changed to read:

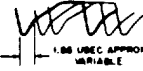
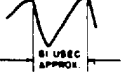
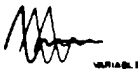
Figure 7-2. Waveform chart for Radiac Sets AN/PDR-27A and -27C.

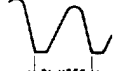
WAVE FORM	OSCILLOSCOPE LEAD CONNECTED TO	RANGE SWITCH POSITION	APPROX. AMPLITUDE (VOLTS PEAK-TO-PEAK)	RADIOACTIVE TEST SAMPLE USED	REMARKS
	PLATE LEAD, V104	500	3.4	NO	CLIP OSCILLOSCOPE LEAD OVER INSULATION (NO DIRECT CONTACT)
	CAP, Z101	500	27	YES	AMPLITUDE MAY VARY BETWEEN 5-VOLT AND 50 VOLTS
	GRID, V104	500	23	NO	NONE
	J101	500	2.75	YES	HEADSET DISCONNECTED
	PIN 6, Z101	50	18.5	YES	NONE
	PIN 5, V104	50	22.5	NO	NONE

NOTE: WAVEFORMS TAKEN ON TEKTRONIX MODEL 512 OSCILLOSCOPE. HORIZONTAL WRITING SPEED SET AT 27×10^{-3} SECONDS/CENTIMETER. ORDINARY OSCILLOSCOPE SHOULD BE SET AT ABOUT 600 SWEEPS PER SEC.

TM5543-CI-6

Figure 7-2.1. (Added) Waveform chart for Radiac Set AN/PDR-27E.

Table 7-1. Trouble Shooting Chart

Symptom	Probable location of fault	Procedure
* * *	* * *	* * *
9. No clicks in headset, meter indicates, on any range when tested with radioactive sample.	Headset and headset jack J101.	Check headset. Check jack J101.
	Plug-in unit Z101.	Check voltages at socket XZ101. If incorrect, replace Z101.
10. Meter indicates upscale when turned on, although no radiation energy present.	V105, V106, R117, R118 or R120 in plug-in unit Z101.	Check resistance between pin 2 of XZ101 and ground; if not between 31K-35K replace, R120 in plug-in unit; if normal remove assembly from can and check other related parts (in Radiac Set AN/PDR-27E only).
	Battery box (A 104).	Check for high resistance path of corrosive material between the terminals of BT102 and BT103; clean terminals if necessary.
11. Meter indication abnormally high; meter appears to be out of calibration.	V107 or other parts of low voltage regulating circuit in plug-in unit Z101.	Check voltages at pins 5, 7, and 11 of Z101; if abnormal replace Z101.

Warning: (Added) High voltage. Do not touch the high voltage supply circuit which includes the cap of V103; terminals for CR101, R101, R102, and C101; switch S101A; anode of the G-M tube V101 and cap connector to plug-in unit Z101.

4. Waveform Chart

(fig. 7-2 or 7-2.1)

Waveforms obtained at * * * is operating correctly.

6. Calibration

Note. Calibration is to be performed at calibration stations only.

a. General. Radiac Set AN/PDR-27A * * * indication is required. **Radiac Calibrator AN/UDM-1 and the technical literature packed with this calibrator are necessary for calibration of the radiac set. If the radiac calibrator is not available the following equipment is required for complete calibration of the radiac set:**

* * * * *

3. For Radiac Sets AN/PDR-27A and -27C only, a special radiac-

meter housing containing four holes that permit access to the calibration potentiometers.

* * * * *

b. Calibration Procedure.

Warning: Calibration of this * * * to the radiation.

Step 1. **In Radiac Sets AN/PDR-27A and -27C, loosen** the six screws securing the radiacmeter panel to the housing. Remove the housing and replace it with the special housing. **In Radiac Set AN/PDR-27E, remove the calibration port cap.** Check the battery * * * of the radiacmeter.

Step 2. Arrange the equipment as indicated in figure 7-5 according to distance measurements given in table 7-1.1. Measure and adjust * * * source in inches.

* * * * *

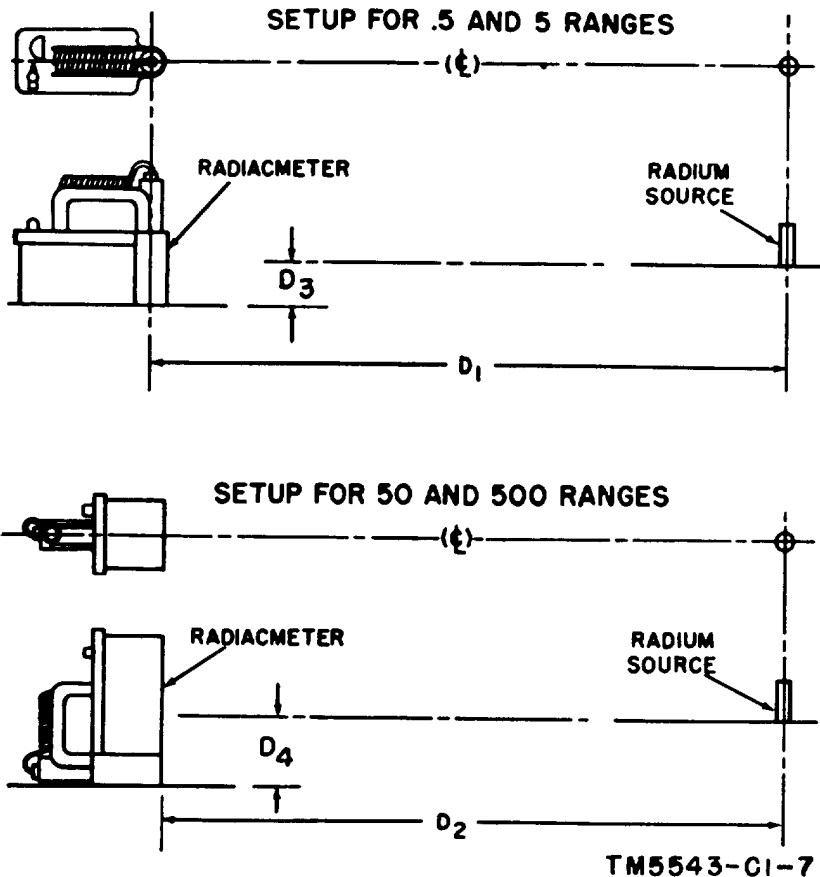

Figure 7-5. (Superseded) Calibration set-up data.

Table 7-1.1. Calibration Set-Up Data
(Added)

Check	Range	Adjust	To read mr/hr	Distances in inches for Radiac Set AN/PDR-27(*)					
				-27A		-27C		-27E	
				D1	D2	D1	D2	D1	D2
1	.5	R110	.40	81.6		80.6		80.6	
2	5	R104	4.0	25.8		25.4		25.4	
3	50	R106	40		7.72		8.06		8.06
4	500	R108	400		2.14		2.54		2.54
Distance D3 for all checks.				2¾		2¾		2¾	
Distance D4 for all checks.				10½		10½		11¾	

Note. Above values apply only to calibration by 2-milligram radium source. Radium source must be set up in line with dimple in steps 3 and 4.

7. Removal and Replacement of Parts

(G. M. tube in probe)

a. Removal of V-102 (fig. 7-6 or 7-6.1).

* * * * *

Step 6. Unscrew the plug * * * the "0" ring. **In Radiac Set AN/PDR-27E, unscrew the threaded ring (0 209) at the end of the probe, and then remove the cap (0 204) (fig. 7-6.1).**

* * * * *

Step 8. With your thumb * * * the probe housing. **In Radiac Set AN/PDR-27E, care should be taken to prevent the mounting cylinder (0 208) from sliding out with V102; otherwise, the lead shield (E201) may become damaged.**

b. Replacement of V-102 (fig. 7-6 or 7-6.1).

* * * * *

Step 7. Slip the washer * * * of the housing. Using the rounded end of the special wrench, tighten the plug. **In Radiac Set AN/PDR-27E replace the anode cap, and then screw the threaded ring (0 209) into the rear of the housing. Tighten the cap and then tighten the cable packing nut (H201).**

* * * * *

c. (Added) *Replacing High Voltage Amplifier V104 (3V4) Tube.* In some 3V4 tubes, the plate current will not cut off at high voltages as required for proper operation in this equipment. In such cases, the current through high voltage regulator V103 (BS101) will be less than 15 microamperes, which is the minimum requirement for proper operation. Therefore, when replacing the 3V4 tube, it may be necessary to try several tubes in order to select one that will give satisfactory operation.

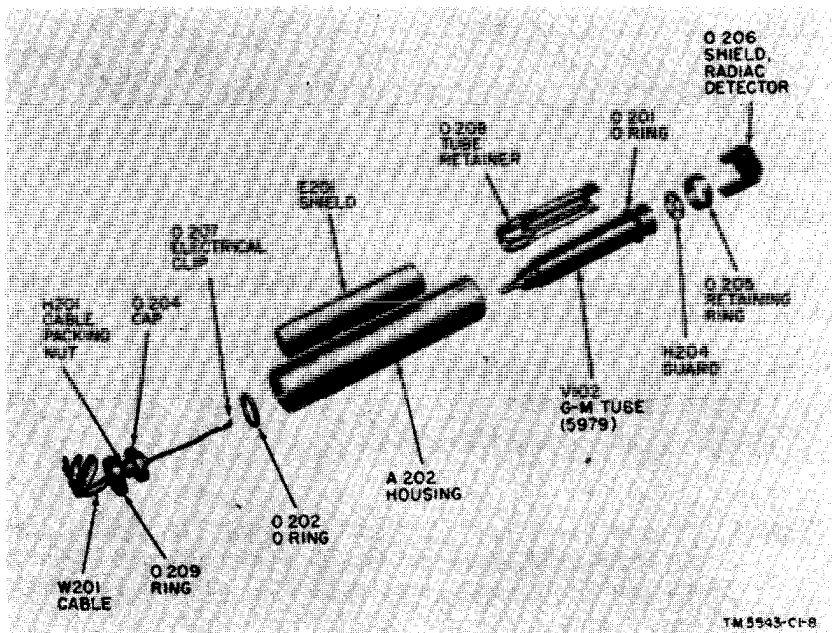

Figure 7-6.1. (Added) Radiac Detector DT-53D/PDR-27, exploded view.

8. Component Characteristics

* * * * *

b. *Winding Data.* Winding data for inductor L-101 are contained in Table 7-4, and for transformer L101 in table 7-4.1.

c. (Added) *Symbol Similarities.* The schematic diagram in figure 7-7 represents Radiac Sets AN/PDR-27A and -27C. Any differences in symbols between Radiac Set AN/PDR-27C and figure 7-7 are shown in table 7-5. The schematic diagram in figure 7-7.1 represents Radiac Set AN/PDR-27E.

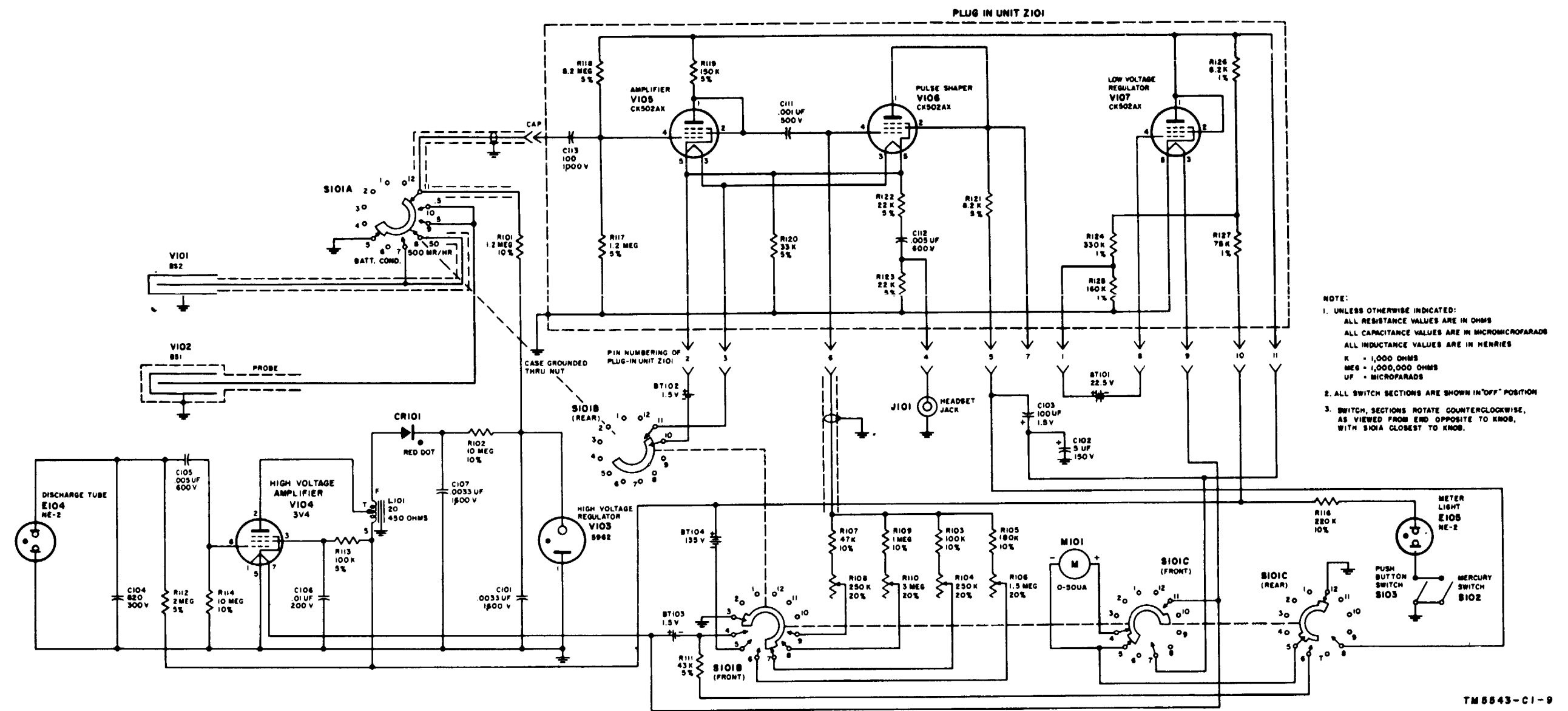

Figure 7-7.1 (Added) Radiacmeter IM-74A/PDR-27C, schematic diagram.

The title of table 7-4 is changed to read:

Table 7-4. Winding Data for the Reactor

Table 7-4.1. WINDING DATA FOR THE TRANSFORMER
(Added)

Designation symbol	Diagram	Winding	Wire	Turns	Dc resistance (ohms)	Hipot Dc volts	Remarks
L101	See figure 7-7.1; L101.	Single center-tapped.	No. 36 Formex insulated.	5050	450	1070	Inductance: 17 hy min, 22 hy max, at 3 ma dc, 400 cps, 10 v.

The following legend is added to the figure on page 7-19:

Figure 7-8. Radiacmeter IM-63/PDR-27A, wiring diagram.

Figure 7-8. The component marked "RADIAC DETECTOR V101" is changed to read: **RADIAC DETECTOR V102.**

*Table 7-5. Component Differences
(Added)*

Component in figure 7-7	Component in Radiac Set AN/PDR 27C
R113, 47K	R113, 100K
R114, 2 meg	R114, 10 meg

Tables 8-1 through 8-4 are rescinded.

[AG 41344 (14 Jan 55)]

BY ORDER OF THE SECRETARY OF THE ARMY:

M. B. RIDGWAY,
General, United States Army,
Chief of Staff

OFFICIAL:

JOHN A. KLEIN,
Major General, United States Army,
The Adjutant General.

DISTRIBUTION:

Active Army:

Tec Svc, DA (1)
Tec Svc Bd (1)
AFF (5)
AFF Bd (incl ea Test Sec) (1)
Army AA Comd (2)
OS Maj Comd (5)
OS Base Comd (5)
Log Comd (3)
MDW (1)
Armies (5)
Corps (2)
Tng Div (2)
Ft & Cp (2)
Gen & Br Svc Sch (5)
SigC Sch (25)
Gen Depots (2)
SigC Sec, Gen Depots (10)
SigC Depots (20)
POE (2)

OS Sup Agencies (2)
SigC Fld Maint Shops (3)
SigC Lab (5)
Mil Dist (1)
Units organized under following
TOE:
8-650A, Med Gen Lab,
Comz (2)
11-127, Sig Rep Co (2)
11-128A, Sig Depot Co (2)
11-500A (AA through AE),
Sig Admin Teams (2)
11-587A, Sig Base Maint
Co (2)
11-592A, Hq & Hq Co, Sig
Base Depot (2)
11-597A, Sig Base
Depot Co (2)

NG: Same as Active Army except allowance is one copy for each unit.

USAR: *None.*

Unless otherwise noted, distribution applies to CONUS and overseas.

For explanation of abbreviations used, see SR 320-50-1.

TECHNICAL MANUAL

RADIAC SETS AN/PDR-27A, -27C, AND -27E

TM 11-5543 }
CHANGES No. 4 }

HEADQUARTERS,
DEPARTMENT OF THE ARMY
WASHINGTON 25, D.C., 26 February 1963

TM 11-5543, 22 August 1952, is changed as follows:

Note. The parenthetical reference to previous changes (*example:* page 1 of C 3) indicates that pertinent material was published in that change.

Page 1-1, paragraph 1.1 (page 1 of C 3).

1.1. Index of Publications

(Superseded)

Refer to the latest issue of DA PAM 310-4 to determine whether there are new editions, changes, or additional publications pertaining to your equipment. Department of the Army Pamphlet No. 310-4 is an index of current Technical Manuals, Technical Bulletins, Supply Bulletins, Lubrication Orders, and Modification Work Orders that are available through publications supply channels. The index lists the individual parts (-10, -20, -35P, etc.) and the latest changes to and revisions of each equipment publication.

1.2. Forms and Records

a. Reports of Unsatisfactory Equipments. Fill out DA Form 2407 (Maintenance Request) in accordance with instructions in TM 38-750 and forward it to—Commanding Officer, U.S. Army Electronics Materiel Support Agency, ATTN: SELMS-PIE, Fort Monmouth, N.J. The form should be filled out and forwarded to report—

- (1) Receipt of defective equipment (use DD Form 6 (*b* below) if defect is due to damaged or improper shipment).
- (2) Equipment deficiencies (deadlined equipments).
- (3) Equipment shortcomings (operable but at less than rated capability or efficiency).
- (4) Equipment improvement suggestions and recommendations.

b. Report of Damaged or Improper Shipment. Fill out and forward DD Form 6 (Report of Damaged or Improper Shipment) as prescribed in AR 700-58 (Army), NAVSANDA Publications 378, and AFR 71-4 (Air Force).

c. Comments on Manual. Forward all comments on this publication direct to—Commanding Officer, U.S. Army Electronics Materiel Support Agency, ATTN: SELMS-MP, Fort Monmouth, N.J. (DA

Form 1598 (Record of Comments on Publications), DA Form 2496 (Disposition Form), or letter may be used.)

Page 3-1, section 3, paragraph 1, step 4. Add:

Step 5. If the equipment has been used or reconditioned, see whether it has been changed by a modification work order (MWO). If modified, an MWO number will appear on the front panel near the nomenclature plate. Check to see whether the MWO number and appropriate notations concerning the modification have been annotated in this manual.

Note. Current MWO's applicable to the equipment are listed in DA Pam 310-4.

Page 5-0, section 5 (page 2 of C 3).

Section 5. OPERATOR'S MAINTENANCE INSTRUCTIONS (Superseded)

1. Scope of Operator's Maintenance

The maintenance duties assigned to the operator of Radiac Set AN/PDR-27(*) are listed below together with a reference to the paragraphs covering the specific maintenance function. The duties assigned do not require tools or test equipment other than those issued with the set.

- a. Daily maintenance service and inspection (par. 5).
- b. Cleaning (par. 6).
- c. Repairs and parts replacement (par. 7).

2. Materials Required for Operator's Maintenance

- a. Cleaning cloth.
- b. Cleaning Compound (Federal stock No. 7930-395-9542).

Warning: Prolonged breathing of cleaning compound is dangerous. Make sure that adequate ventilation is provided. Cleaning compound is flammable; do not use near an open flame.

3. Operator's Preventive Maintenance

Operator's preventive maintenance is the systematic care, servicing, and inspection of equipment to prevent trouble, to reduce downtime, and to assure that the equipment is serviceable.

a. *Systematic Care.* The procedures given in paragraph 5 cover systematic care essential to proper upkeep and operation of the equipment. The cleaning procedure (par. 6) should be performed once a day. If the equipment is not used daily, the cleaning procedure must be performed before operation, after any extended shutdown, or once a week while the equipment is kept in *standby* condition.

b. *Daily Maintenance Service and Inspection.* The daily maintenance service and inspection chart (par. 5) outlines inspection to be made at specific intervals. These inspections are made to determine

combat serviceability; that is, to determine that the equipment is in good general (physical) condition, in good operating condition, and likely to remain combat serviceable. To assist the operators in determining and maintaining combat serviceability, the chart indicates what to inspect, how to inspect, and what the normal conditions are; the *Reference* column lists the paragraph that contains additional information. If the defect cannot be remedied by the operator, higher echelon maintenance or repair is required. Records and reports of these inspections must be made in accordance with TM 38-750.

4. Operator's Maintenance Service and Inspection Periods

Maintenance service and inspection of Radiac Set AN/PDR-27(*) is required daily. Paragraph 5 specifies the items to be inspected and serviced. In addition to the routine daily services and inspection, the equipment should be reinspected and serviced immediately before going on a mission and as soon after completion of the mission as possible.

5. Daily Maintenance Service and Inspection Chart

Note. The item numbers in the chart below are not consecutive; they are taken from the complete quarterly maintenance service and inspection chart (Sec. 6, par. 7).

Item No.	Procedure		Reference
	Item	Normal condition or result	
1	SET: Inspect the equipment for completeness, cleanliness, and proper installation.	Equipment is complete, clean, and installed for operation.	TM 11-6665-201-12P and par. 6; sec. 3, par. 2.
2	PUBLICATIONS: Check to see that pertinent publications are available (app., TM 11-5543).	a. Operator's instructions are complete and in usable condition without missing pages. b. All Changes pertinent to the equipment are on hand (DA Pam 310-4).	a. Sec. 4, pars. 2, 3, and 4. b. DA Pam 310-4 for requirements.
5	CONNECTIONS: Check the battery connections and the headset jack.	Plugs and headset jack (fig. 1-2) are clean, intact, and not loose fitting.	Sec. 3, par. 2.
6	KNOB and SWITCH: Check for proper mechanical action by setting the control to each of its possible settings.	Action is positive without binding or scraping.	Sec. 2, par. 3d.

6. Cleaning

Inspect the exterior of the radiac set and the exterior and interior of the carrying case. The exposed surfaces should be clean, free of dust, dirt, grease, and fungus.

a. Remove dust and loose dirt with a clean soft cloth.

Warning: Cleaning compound is flammable and its fumes are toxic. Provide adequate ventilation. Do not use near a flame.

b. Remove grease, fungus, and ground-in dirt from the cases; use a cloth dampened (not wet) with cleaning compound.

c. Remove dust or dirt from plugs and jacks.

Caution: Do not press on the meter face (glass) when cleaning; the meter may be damaged.

d. Clean the front panel, meter, and control knob; use a soft clean cloth. If the removal of dirt is difficult dampen the cloth with water; mild soap may be used to make the cleaning more effective.

7. Repairs and Parts Replacement (Operator)

a. *Repairs.* No repairs (other than battery replacement) of the radiac set are authorized to the operator.

b. *Parts Replacement.* The following batteries are replaceable (sec. 3, par. 2) by the operator:

(1) Battery BA-416/U.

(2) Battery BA-401/U.

(3) Battery BA-413/U.

Page 6-0, section 6 (page 3 of C 3).

Section 6. ORGANIZATIONAL MAINTENANCE INSTRUCTIONS

(Superseded)

1. Scope of Organizational Maintenance

a. This section contains instructions covering second echelon maintenance of Radiac Set AN/PDR-27(*). It includes instructions on performing preventive and periodic maintenance services, troubleshooting, and repair functions to be accomplished by the organizational repairman.

b. Second echelon maintenance of the radiac set includes:

(1) Monthly maintenance (par. 5).

(2) Quarterly maintenance service and inspection (par. 7).

(3) Organizational troubleshooting (sec. 7).

(4) Parts replacement and continuity checks (sec. 7).

2. Tools, Materials, and Test Equipment Required (Second Echelon)

In addition to the materials listed for the operator (sec. 5, par. 2), Screwdriver TL-358/U (FSN 5120-277-9491) is required.

3. Organizational Preventive Maintenance

a. Organizational preventive maintenance is the systematic care, inspection, and servicing of equipment to maintain it in serviceable condition, prevent breakdowns, and assure maximum operational capability. Preventive maintenance is the responsibility of all echelons concerned with the equipment and includes the inspection, testing, and replacement of parts that inspection and tests indicate would probably fail before the next scheduled periodic service. Preventive maintenance service and inspection of the radiac set at the second echelon level is made at monthly and quarterly intervals unless otherwise directed by the Commanding Officer.

b. Maintenance forms and records to be used and maintained on this equipment are specified in TM 38-750. Paragraph 1.2 contains additional information concerning submission of specific forms.

4. Monthly Maintenance

Perform the maintenance functions indicated in the monthly maintenance service and inspection chart (par. 5) once each month. A month is defined as approximately 30 calendar days of 8-hour-per-day operation. If the equipment is operated 16 hours a day, the monthly maintenance should be performed at 15-day intervals. Adjustment of the maintenance interval must be made to compensate for any unusual operating conditions. Equipment maintained in a standby (ready for immediate operation) condition, requires monthly maintenance. Equipment in limited storage (requires service before operation) does not require monthly maintenance.

5. Monthly Maintenance Service and Inspection Chart

Note. The item numbers in the chart below are not consecutive; they are taken from the complete quarterly maintenance service and inspection chart (par. 7).

Item No.	Procedure		Reference
	Item	Normal condition or result	
1	SET: Inspect the equipment for preservation.	Painted surfaces are free of bare spots, rust and corrosion.	Sec. 6, par. 8.
3	MODIFICATION WORK ORDERS: Check DA Pam 310-4 to determine if new applicable MWO's have been published.	All URGENT MWO's have been applied to the equipment. All ROUTINE MWO's have been scheduled.	Sec. 3, par. 1, step 5.
6	KNOB and SWITCH: Check for proper mechanical action by setting the control to each of its possible settings.	Action is positive without binding or scraping. <i>Note.</i> A knob that requires frequent tightening should have setcrew replaced.	Sec. 2, par. 3d.
7	CABLES: Check cables for breaks, cuts, kinks, deterioration, strain, and fraying.	Cables are clean, flexible, intact, and in apparent good condition.	Fig. 1-2 and 3-2.
8	BATTERIES: Inspect batteries for physical condition and electrical condition.	Batteries are clean, not deformed, are in good physical condition, and properly operate the unit.	Sec. 3, par. 3.
9	BATTERY COMPARTMENT: Open battery compartment door and inspect interior for evidence of water leakage, condensation, and corrosion.	Battery compartment is clean and dry.	Fig. 3-2.

6. Quarterly Maintenance

Quarterly maintenance of Radiac Set AN/PDR-27(*) will be scheduled in accordance with the requirements in TM 38-750. All deficiencies or shortcomings will be recorded, and those not corrected during the inspection and service will be immediately reported to higher echelon, using forms and procedures specified in TM 38-750. Equipment that has a deficiency that cannot be corrected by second echelon should be deadlined in accordance with TM 38-750. Perform all the services listed in the quarterly maintenance service and inspection chart (par. 7) in the sequence listed. Whenever a *normal condition or result* is not observed, take the corrective action in accordance with the paragraph listed under *references*.

7. Quarterly Maintenance Service and Inspection Chart

Item No.	Procedure		Reference
	Item	Normal condition or result	
1	SET: Inspect the equipment for: a. Completeness. b. Proper installation. c. Cleanliness. d. Preservation.	a. Equipment must be complete. b. Installation is in accordance with figure 3-2. c. Units must be clean and dry, inside and out; free of grease, dirt, rust, corrosion, and fungus. d. Painted surfaces must be free of bare spots, rust, and corrosion.	a. TM 11-6665-201-12P. b. Sec. 3, pars. 2 and 3. c. Sec. 5, par. 6. d. None.
2	PUBLICATIONS: Check to see that pertinent publications are available.	a. Operator's instructions must be complete and in usable condition without missing pages. b. All Changes pertinent to the equipment are on hand (DA Pam 310-4).	a. Sec. 4, par. 2, 3, and 4. b. DA Pam 310-4 for requirements.
3	MODIFICATION WORK ORDERS: Check DA Pam 310-4 to determine if new applicable MWO's have been published.	All URGENT MWO's have been applied to the equipment. All ROUTINE MWO's have been scheduled.	Sec. 3, par. 1, step 5.
4	GASKETS: Inspect waterproof gaskets for leaks, worn, or loose edges.	Gaskets are clean, flexible, and in apparent good condition.	
5	CONNECTIONS: Check the battery connectors and the headset jack.	Plugs and jack are clean, intact, and not loose fitting.	Sec. 3, par. 2.
6	KNOB and SWITCH: Check for proper mechanical action by setting the control to each of its possible settings.	Action is positive without binding or scraping. <i>Note.</i> A knob that requires frequent tightening should have setscrew replaced.	
7	CABLES: Check cables for breaks, cuts, kinks, deterioration, strain, and fraying.	Cables are clean, flexible, intact, and in apparent good condition.	

Item No.	Procedure		Reference
	Item	Normal condition or result	
8	BATTERIES: Inspect batteries for physical condition and electrical condition.	Batteries are clean, not deformed, are in good physical condition and properly operate the unit.	Sec. 3, par. 3.
9	BATTERY COMPARTMENT: Open battery compartment door and inspect interior for evidence of water leakage, condensation, and corrosion.	Battery compartment is clean and dry.	

8. Cleaning and Touch-Up Painting Instructions

Clean rust and corrosion from metal surfaces by lightly sanding them with fine sandpaper. Brush two thin coats of paint on the bare metal to protect it from further corrosion. Refer to applicable cleaning and refinishing practices specified in TM 9-2851 (Painting Instructions for Field Use).

Page 7-12, section 7, paragraph 7a, step 4. Change "H-103" to: **H-301**.

Page 8-6, section 8, table 8-2, "Federal and (Signal Corps) Stock No." column. Change "6R57690-1" to: **6665-378-5615**.

Page 8-22, appendix (as added by C 3, page 11). Add the following references:

DA Pamphlet 310-4	Index of Technical Manuals, Technical Bulletins, Supply Bulletins, Lubrication Orders, and Modification Work Orders.
TM 38-750	The Army Equipment Record System and Procedures.
TM 9-2851	Painting Instructions for Field Use.

By Order of the Secretary of the Army:

EARLE G. WHEELER,
General, United States Army,
Chief of Staff.

Official:

J. C. LAMBERT,
Major General, United States Army,
The Adjutant General.

Distribution:

Active Army:

DASA (6)	OS Base Comd (2)
USASA (2)	LOGCOMD (2)
CNGB (1)	MDW (1)
CofEngrs (1)	Armies (2)
CofT (1)	Corps (2)
TSG (1)	Instls (2) except
CSigO (5)	Fort Monmouth (63)
AMC (5)	Fort Belvoir (5)
USA Engr CD Agcy (1)	Fort Holabird (5)
USA CBR CD Agcy (1)	USAINTC (5)
USA Comm Elet CD Agcy (1)	USATC AD (2)
USA Med Svc CD Agcy (1)	USATC Engr (2)
USA Ord CD Agcy (1)	USATC Inf (2)
USA QM CD Agcy (1)	USATC Armor (2)
USA Trans CD Agcy (1)	USMA (5)
USCONARC (5)	Svc Colleges (2)
ARADCOM (2)	Br Svc Sch (2)
ARADCOM Rgn (2)	GENDEP (OS) (2)
OS Maj Comd (3)	Sig Sec, GENDEP (OS) (5)

Sig Dep (OS) (12)		USA Corps (3)				
Dep (OS) (2)		JBUSMC (2)				
Army Dep (2) except		Units org under fol TOE:				
Lexington Army Dep (12)		(2 copies each UNOINDC)				
Sacramento Army Dep (17)	3-7	7-25	9-67	11-597	30-600	
Tobyhanna Army Dep (12)	3-47	7-26	9-87	12-52	(AA-	
Fort Worth Army Dep (8)	3-500	7-31	9-377	17	AE)	
USA Msl Comd (4)	(AA-	7-32	9-500	17-2	37	
WRAMC (1)	AC)	7-42	(AA-	17-4	37-42	
William Beaumont Gen Hosp (5)	5-5	7-52	AC)	17-25	37-100	
Trans Tml Comd (1)	5-6	7-100	10-7	17-26	37-102	
Army Tml (1)	5-15	7-102	10-17	17-32	39-51	
POE (1)	5-16	8-15	10-45	17-35	39-62	
OSA (1)	5-25	8-16	10-47	17-36	39-401	
Dugway PG (5)	5-26	8-35	10-48	17-42	41-500	
Jefferson PG (5)	5-38	8-36	10-105	17-45	(AA-	
USA Elct Rsch & Dev Acty (2)	5-45	8-67	10-107	17-46	AC)	
Fort Huachuca	5-46	8-75	10-349	17-51	44-2	
USAERDL (5)	5-115	8-76	10-445	17-52	44-12	
Yuma Test Sta (2)	5-116	8-122	10-447	17-55	51-2	
AFIP (1)	5-145	8-127	10-467	17-56	52-2	
AMS (1)	5-146	8-128	10-500	17-65	55-52	
Army Pictorial Cen (2)	5-155	8-137	(AA-	17-66	55-157	
USA MOB Spt Cen (1)	5-156	8-187	AD)	17-85	55-202	
USA Strat Comm Comd (4)	5-225	8-204	11-7	17-86	55-302	
USA Elct Mat Agcy (25)	5-226	8-500	11-16	17-100	57	
Chicago Proc Dist (1)	5-327	(AA-	11-32	17-102	57-4	
USARCARIB Sig Agcy (1)	5-600	AH)	11-57	17-105	57-5	
USA Elct Rsch & Dev Acty (13)	5-601	8-563	11-97	17-106	57-6	
White Sands	6-100	8-565	11-117	20	57-42	
Engr Cen (5)	6-101	8-566	11-155	29-1	57-100	
Def Elct Sup Cen (1)	6-300	8-567	11-157	29-5	57-102	
Def Tfc Mgt Svc (1)	6-301	8-571	11-500	29-7		
USAECOM (5)	6-302	8-581	(AA-	29-21		
Fld Comd, DASA (2)	6-401	8-650	AE)	29-25		
Sig Fld Maint Shops (3)	6-501	8-667	(4)	29-27		
Def Log Svc Cen (1)	7	9-12	11-557	29-51		
	7-2	9-22	11-587	29-65		
	7-4	9-65	11-592	29-307		

NG: State AG (3); units—same as Active Army except allowance is one copy for each unit.

USAR: None.

For explanation of abbreviations used, see AR 320-50.

CHANGE }
No. 5 }

HEADQUARTERS
DEPARTMENT OF THE ARMY
WASHINGTON, D.C., 23 September 1965

**RADIAC SETS AN/PDR-27A, AN/PDR-27C,
AND AN/PDR-27E**

TM 11-5543, 22 August 1952, is changed as follows:

Note. The parenthetical reference to previous changes (example: page 1 of C 4) indicate that pertinent material was published in that change.

Inside Front Cover (As added by C 3, 8 Feb 1962). Delete the warning symbol and substitute:

**WARNING
RADIATION HAZARD**

*This change supersedes C 3, 8 February 1962, so much of TM 11-6665-201-12P, 10 October 1960, and TM 11-6665-201-35P, 10 October 1960, as pertains to Radiac Sets AN/PDR-27A and AN/PDR-27E, and replaces Signal Corps Repair Standard No. REP-629, Issue No. 1, 11 January 1956.

Radioactive Test Sample MX-1083/PDR-27 contains the equivalent of 5 microcuries of cobalt 60; Radioactive Test Sample MX-1083B/PDR-27 contains 7 micrograms of radium. Be extremely careful while using these test samples, and follow safe procedures for handling, storage, and disposal (AR 700-52, AR 700-380, and TB SIG 225).

Page 1-1. Delete paragraphs 1.1 and 1.2 (page 1 of C 4) and substitute:

1.1. Index of Publications

Refer to the latest issue of DA Pam 310-4 to determine whether there are new editions, changes, or additional publications pertaining to the equipment. DA Pam 310-4 is an index of current technical manuals, technical bulletins, supply manuals (types 7, 8, and 9), supply bulletins, lubrication orders, and modification work orders available through publications supply channels. The index lists the individual parts (-10, -20, -35P, etc) and the latest changes to and revisions of each equipment publication.

1.2. Forms and Records

a. Reports of Maintenance and Unsatisfactory Equipment. Use equipment forms and records in accordance with instructions in TM 38-750.

b. Report of Damaged or Improper Shipment. Fill out and forward DD Form 6 (Report of Damaged or Improper Shipment) as prescribed in AR 700-58 (Army), NAVSANDA Publication 378 (Navy), and AFR 71-4 (Air Force).

c. Reporting of Equipment Manual Improvements. The direct reporting, by the individual user, of errors, omissions, and recommendations for improving this manual is authorized and encouraged. DA Form 2028 (Recommended Changes to DA Publications) will be used for reporting these improvement recommendations. This form will be completed using pencil, pen, or typewriter and forwarded direct to Commanding General, U.S. Army Electronics Command, ATTN: AMSEL-MR-(NMP)-MA, Fort Monmouth, N.J., 07703.

Page 1-10, table 1-4 (As changed by C 3, 8 Feb 1962), "Radiac Set AN/PDR-27C" column, line 7. Delete "Turned on by tilting radiacmeter or by using panel push button" and substitute: Turned on by tilting radiacmeter or by pressing push button H116 (fig. 1-7).

Page 6-0, paragraph 8 (page 11 of C 4), line 4. Delete "TM 9-2851 (Painting Instructions for Field Use)" and substitute: TB SIG 364.

Page 7-8, paragraph 6, caution (As added by C 3, 8 Feb 1962). Delete the caution notice and substitute:

Caution: Do not force any calibration adjustment (R104, R106, R108, or R110) beyond its limit stops; the contact arms may be broken.

Delete paragraph 6.1 (As added by C 3, 8 Feb 1962) and substitute:

6.1. Calibration of Radiac Set AN/PDR-27(*) With Calibrator Set, Radiac TS-784(*)/PD

Calibrator Set, Radiac TS-784(*)/PD may be used to calibrate the AN/PDR-27(*). Instructions for using the TS-784(*)/PD during calibration of the AN/PDR-27(*) are included in TM 11-6665-204-12.

Page 7-11. Delete figures 7-5.1 and 7-5.2 (As added by C 3, 8 Feb 1962).

Page 8-22. Add section 9 (page 24 of C 1) after section 8.

SECTION 9 DEPOT INSPECTION STANDARDS

1. Applicability of Depot Inspection Standards

Radiac Set AN/PDR-27A, AN/PDR-27C, or AN/PDR-27E must be tested thoroughly after rebuild or repair to insure that it meets adequate performance standards for return to stock or for reissue. Use the tests described in this section to measure the performance of the repaired radiac set. It is mandatory that repaired equipment to be reissued or returned to stock meets all performance standards given in this section.

2. Applicable References

a. Repair Standards. Applicable procedures of the depot performing this test and the general standards for repaired electronic equipment given in TB SIG 355-1, TB SIG 355-2, and TB SIG 355-3 form a part of the requirements for testing this equipment.

b. Modification Work Orders. Perform all modification work orders applicable to this equipment before making the tests specified. DA Pam 310-4 lists all available MWO's.

3. Test Equipment Required

The following test equipment is required to determine whether the radiac set complies with the depot inspection standards.

- a.* Radiac Calibrator Set AN/UDM-1.
- b.* Test Set, Electron Tube AN/USM-23.
- c.* Test Set, Electron Tube TV-2(*)/U (includes TV-2/U, TV-2A/U, TV-2B/U, and TV-2C/U).

4. General Test Requirements

- a.* Perform all tests at normal room temperature.
- b.* Before testing the equipment, allow 15 minutes for it to reach a stable temperature.

5. Operational Test

a. Operate the range switch (fig. 1-2) to the BATT COND position; the meter must indicate to the right of the line marked BATT on the meter face.

b. Position the radiacmeter so that the meter is tilted at an angle greater than 45° to the earth's surface; the meter face must be illuminated by the internal lamp.

Note. On the AN/PDR-27E, press pushbutton A110 (fig. 1-6); the meter face must be illuminated by the internal lamp.

c. Connect the H-43/U to the headset jack (fig. 1-2), and operate the range switch to 500. Hold radioactive test sample MX-1083/PDR-27 (AN/PDR-27A) or MX-1083B/PDR-27 (AN/PDR-27C and AN/PDR-27E) under the radiacmeter (A, fig. 3-3 and A, fig. 3-3.1); a clicking sound must be heard in the H-43/U.

6. Removal of Tubes V101 Through V104

Tube V101 (BS-2) is secured to the inside of the radiacmeter by two clips (figs. 1-3 and 1-4.1), tube V102 (BS-1) is located inside the radiac detector (figs. 7-6 and 7-6.1), and tube V103 (BS-101) is plugged into a tube socket inside the radiacmeter (figs. 1-4 and 1-4.1). Remove these tubes as follows:

a. Position the radiacmeter so that the carrying handle is at the top (fig. 1-2).

b. Loosen the six screws that secure the panel to the housing.

c. Grasp the carrying handle, life the panel from the housing, and turn the panel over so that the bottom of the panel is exposed (figs. 1-3 and 1-4.1).

d. Lift tube V101 from the clips that secure it to the panel.

e. Slide the connector off the cap on tube V103. Pull tube V103 from its socket.

f. Pull the spring holder from the top of tube V104. Pull tube V104 from its socket.

g. Remove tube V102 from the radiac detector (sec 7, para 7; page 21 of C 1).

7. Testing Tubes V101 Through V104

a. Test tube V104 with the TV-2(*)/U. Tube V104 must have no short circuits or excessive gas, and its transconductance must exceed the minimum limit specified on the tube test data roll chart in the TV-2(*)/U.

Note. The AN/USM-23 is a tube tester designed to test tubes V101, V102, and V103. Instructions for the use of the AN/USM-23 are contained in the instruction book attached to the AN/USM-23.

b. Test tube V102 with the AN/USM-23.

- (1) The H COUNTING RATE index associated with the radiation intensity control on the AN/USM-23 must indicate GOOD for the gamma response test.

(2) The indicating meter on the AN/USM-23 must indicate GOOD for the relative plateau slope and the gamma sensitivity tests.

c. Test tube V101 with the AN/USM-23.

(1) The H COUNTING RATE index associated with the radiation intensity control on the AN/USM-23 must indicate GOOD for the gamma response test.

(2) The indicating meter on the AN/USM-23 must indicate GOOD for the relative plateau slope and the gamma sensitivity tests.

d. Test tube V103 with the AN/USM-23. The K REGULATOR TEST index associated with the regulator test control must indicate GOOD for the operating voltage test and for the voltage regulation test.

e. Replace tube V102 (sec 7, para 7; page 21 of C 1) in the radiac detector.

f. Replace tubes V101, V103, and V104 in the radiacmeter (fig. 1-3 and 1-4.1); replace the spring holder on the top of tube V104, and slide the connector on the cap of tube V103.

g. Secure the panel (fig. 1-2) to the housing with the six screws.

8. Checking Calibration

Note. Before checking the calibration of the AN/PDR-27E, the positions of the X-axis bar, the Y-axis bar, and the height control of Radiac Calibrator Set AN/UDM-1 must be determined according to the instructions in TM 11-1176. The positions of the X-axis bar, the Y-axis bar, and the height control for checking calibration of the AN/PDR-27A and the AN/PDR-27C are listed in TM 11-1176.

Check the calibration of each of the four ranges of the radiacmeter at four-fifths (0.4, 4, 40, and 400) of full-scale value with Radiac Calibrator Set AN/UDM-1. The meter indication must be four-fifths of full-scale value ± 20 percent on each range. Instructions for operating the AN/UDM-1 are contained in TM 11-1176.

Appendix (page 11 of C 4) (As added by C 3, 8 Feb 1962). Delete the appendix and substitute:

APPENDIX I REFERENCES

Following is a list of applicable references available to the operating and maintenance personnel of Radiac Sets AN/PDR-27A, AN/PDR-27C, and AN/PDR-27E.

AR 700-52	Licensing and Control of Radioactive Materials.
AR 755-380	Disposal of Unwanted Radioactive Material.
DA Pam 310-4	Index of Technical Manuals, Technical Bulletins, Supply Manuals (Types 7, 8, and 9), Supply Bulletins, Lubrication Orders, and Modification Work Orders.

SB 11-573	Painting and Preservation Supplies Available for Field Use for Electronics Command Equipment.
TB SIG 225	Identification and Handling of Radioactive Signal Items.
TB SIG 364	Field Instructions for Painting and Preserving Electronics Command Equipment.
TM 11-1176	Instruction Book for Radiac Calibrator Set AN/UDM-1.
TM 11-6665-204-12	Operator and Organizational Maintenance Manual, Calibrator Sets, Radiac TS-784/PD and TS-784A/PD.
TM 38-750	Army Equipment Record Procedures.

Add appendixes II, III, and IV after appendix I:

APPENDIX II

BASIC ISSUE ITEMS LIST

Section I. INTRODUCTION

1. General

a. This appendix lists items supplied for initial operation. The list includes tools, parts, and material issued as part of the major end item. The list includes all items authorized for basic operator maintenance of the equipment. End items of equipment are issued on the basis of allowances prescribed in equipment authorization tables and other documents that are a basis for requisitioning.

b. Columns are as follows:

- (1) *Federal stock number.* This column lists the 11-digit Federal stock number.
- (2) *Designation by model.* The dagger symbol (†) indicates the model in which the item is used.
- (3) *Description.* Nomenclature or the standard item name and brief identifying data for each item are listed in this column. When requisitioning, enter the nomenclature and description.
- (4) *Unit of issue.* The unit of issue is each unless otherwise indicated and is the supply term by which the individual item is counted for procurement, storage, requisitioning, allowances, and issue purposes.
- (5) *Expendability.* Nonexpendable items are indicated by NX. Expendable items are not annotated.
- (6) *Quantity authorized.* Under "Items Comprising an Operable Equipment", the quantity of items supplied for initial operation of the equipment is listed.
- (7) *Illustration.* The numbers in the "Figure No." column refer to the illustrations where the part is shown. The "Item No."

column lists the reference designations that appear on the part in the equipment; these same designations are illustrations of the equipment.

2. Batteries

Dry batteries listed are used with the equipment but are not considered part of the equipment. They are not preshipped automatically but must be requisitioned in quantities necessary for the particular organization, in accordance with SB 11-6.

Section II. OPERATORS FUNCTIONAL PARTS LIST

Federal stock No.	Designation by model					Description	Unit of issue	Exp	Qty auth	Illustration	
										Figure No.	Item No.
						RADIAC SET AN/PDR-27A, AN/PDR-27E					
6665-526-5334						RADIAC SET AN/PDR-27A, AN/PDR-27E for detecting and measuring rate of received beta and gamma radiations together or gamma radiations alone. Range of detection 0-500 milliroentgens per hour. Scale 0-.5, 0-5, 0-50, 0-500 MR/hr. NOTE: Model column 1 refers to AN/PDR-27A; column 2 refers to AN/PDR-27E.		NX		1-1	
						ITEMS COMPRISING AN OPERABLE EQUIPMENT					
ORD THRU AGC.	†	†				TECHNICAL MANUAL TM 11-5543			2		
6665-547-1040	†	†				CASE CY-963, A, B, C/PDR-27A		NX	1	1-1	
5965-240-4487	†					HARNESST-119/PDR-27			1	1-1	
6665-392-7466		†				HARNESST-125, A/PDR-27E			1		
5965-651-7372	†	†				HEADSET, ELECTRICAL H-43B/V		NX	1	1-1	
6665-392-7461	†	†				RADIACMETER IM-74A/PDR-27A		NX	1		
6665-330-9519	†					RADIOACTIVE TEST SAMPLE MX-1083/PDR-27		NX	1	1-1	
6665-694-2021		†				RADIOACTIVE TEST SAMPLE MX-1083B/PDR-27		NX	1	3-3	
6665-312-8096	†					STRAP, BUNDLING: Tracerlab-Keleket #A230297			1	3-3.1	
						RADIACMETER IM-74A/PDR-27C					
6135-164-8753						BATTERY, DRY BA-401/U: (For Reference Only)				3-2	BT-102 BT-103

FORM 8-62 6829 OGVJ

TAGO 8808-B

6135-164-8754						BATTERY, DRY BA-413/U: (For Reference Only)-----				3-2	BT-101
6135-164-8768						BATTERY, DRY BA-416/U: (For Reference Only)-----				3-2	BT-104
5120-383-0964						WRENCH, OPEN END, FIXED: Admiral P/N 515A174, Specialty P/N M1-3.	NX	1		1-1	H301
5120-224-2504						WRENCH, SOCKET HEAD, HEX: $\frac{3}{16}$ in. across flats, $1\frac{3}{4}$ in. lg, for #8 setscrew.	NX	1		1-1	H302
RUNNING SPARE ITEMS											
No parts authorized for stockage at operators level											

APPENDIX III

MAINTENANCE ALLOCATION

Section I. INTRODUCTION

1. General

a. This appendix assigns maintenance functions to be performed on components, assemblies, and subassemblies by the lowest appropriate maintenance category.

b. Columns in the maintenance allocation chart are as follows:

- (1) *Part or component.* This column shows only the nomenclature or standard item name. Additional descriptive data are included only where clarification is necessary to identify the component. Components, assemblies, and subassemblies are listed in top-down order. That is, the assemblies which are part of a component are listed immediately below that component, and subassemblies which are part of an assembly are listed immediately below that assembly. Each generation breakdown (components, assemblies, or subassemblies) are listed in disassembly order or alphabetical order.
- (2) *Maintenance function.* This column indicates the maintenance functions allocated to the categories.
 - (a) *Service.* To clean, to preserve, and to replenish lubricants.
 - (b) *Inspect.* To verify serviceability and detect incipient electrical or mechanical failure by scrutiny.
 - (c) *Test.* To verify serviceability and to detect incipient electrical or mechanical failure by use of special equipment such as gages, meters, etc.
 - (d) *Replace.* To substitute serviceable components, assemblies, or subassemblies for unserviceable components, assemblies, or subassemblies.
 - (e) *Repair.* To restore an item to serviceable condition through correction of a specific failure or unserviceable condition. This function includes but is not limited to welding, grinding, riveting, straightening, and replacement of parts other than the trial and error replacement of running spare type items such as fuses, lamps, or electron tubes.
 - (f) *Calibrate.* To determine, check, or rectify the graduation of an instrument, weapon, or weapons system, or components of a weapons system.
 - (g) *Overhaul.* To restore an item to *completely serviceable* condition as prescribed by serviceability standards. This is accomplished through employment of the technique of "Inspect and Repair Only as Necessary" (IROAN). Maximum utilization of diagnostic and test equipment is combined

with minimum disassembly of the item during the overhaul process.

- (h) *Rebuild*. To restore an item to a standard as near as possible to original or new condition in appearance, performance, and life expectancy. This is accomplished through the maintenance technique of complete disassembly of the item, inspection of all parts or components, repair or replacement of worn or unserviceable elements using original manufacturing tolerances and/or specifications and subsequent reassembly of the item.
- (3) *Operator crew (O/C), organizational (O), direct support (DS), general support (GS), and depot (D)*. The symbol X indicates the categories responsible for performing that particular maintenance operation, but does not necessarily indicate that repair parts will be stocked at that level. Categories higher than those marked by X are authorized to perform the indicated operation.
- (4) *Tools required*. This column contains a list of tool, test, and maintenance equipment, by tool code numbers (c(3) below), that is required for each maintenance function. Each group of codes opposite a maintenance function lists all tool, test, and maintenance equipment required to perform the maintenance function.
- (5) *Remarks*. Entries in this column will be utilized when necessary to clarify any of the data in the preceding column.

c. Columns in the allocation of tools for maintenance functions are as follows:

- (1) *Tools required for maintenance functions*. This column lists tool, test, and maintenance equipment required to perform the maintenance functions.
- (2) *Operator crew, organizational, direct support, general support, and depot*. The categories of maintenance to which each tool, test, or maintenance equipment is allocated is indicated by the dagger symbol (†).
- (3) *Tool code*. This column lists the tool code number assigned to each tool, test, or maintenance equipment.

2. Maintenance by Using Organizations

When this equipment is used by signal services organizations organic to theater headquarters or communication zones to provide theater communications, those maintenance functions allocated up to and including general support are authorized to the organization operating this equipment.

Section II. MAINTENANCE ALLOCATION CHART

Part or component	Maintenance function	O/C	O	DS	GS	D	Tools required	Remarks	
RADIAC SET AN/PDR-27A, AN/PDR-27E.....	service.....	X						Depot facilities and parts fabrication. For maintenance allocation see TM 11-5965-247-12P.	
	inspect.....	X							
	test.....				X		1, 2, 3, 6, 7		
	repair.....		X				X		1, 2, 3, 4, 5, 7 8, 10
	calibrate.....					X			1, 2, 5, 7, 8, 9, 10
	rebuild.....						X		1, 2, 3, 4, 5, 7
CASE CY-963, A, B, C/PDR-27A.....	overhaul.....					X			1, 2, 3, 6, 7
	replace.....	X							1, 2, 3, 4, 5, 7, 8, 9, 10
	repair.....					X			
HEADSET, ELECTRICAL H-43B/U.....	replace.....		X						
RADIACMETER IM-74A/PDR-27C.....	replace.....		X						
	repair.....		X				8, 10		

Section III. ALLOCATION OF TOOLS FOR MAINTENANCE FUNCTION

Tools required for maintenance functions	O/C	O	DS	GS	D	Tool code	Remarks
AN/PDR-27A, -27E							
MULTIMETER TS-352/U.....				†	†	1	Army, STD A
OSCILLOSCOPE OS-8/U.....				†	†	2	Navy, STD A
RADIAC CALIBRATOR TS-784/PD.....				†	†	3	Army, STD A
RADIAC CALIBRATOR SET AN/UDM-1.....					†	4	Navy, STD A
TEST SET, ELECTRON TUBE TV-2/U.....					†	5	Army, STD A
TEST SET, ELECTRON TUBE TV-7/U.....				†		6	Army, STD A
TEST SET, TRANSISTOR TS-1835/U.....				†	†	7	Army, STD A
SCREWDRIVER TL-358/U.....		†		†	†	8	Army, STD A
TOOL KIT TK-87/U.....				†	†	9	Army, STD A
WRENCH TL-111/U.....		†		†	†	10	Army, STD A

APPENDIX IV

REPAIR PARTS AND SPECIAL TOOLS LISTS

Section I. INTRODUCTION

1. General

a. This manual includes an organizational maintenance repair parts and special tools list and a general support and depot maintenance repair parts and special tools list.

- (1) The organizational maintenance repair parts and special tools list contains a list of the repair parts authorized for organizational maintenance and is a basis for requisitioning by organizations which are authorized the major item of equipment. End items of equipments are issued on the basis of allowances prescribed in equipment authorization tables and other documents that are a basis for requisitioning.
- (2) The general support and depot maintenance repair parts and special tools list shows the quantities of repair parts authorized for general support maintenance and is a basis for requisitioning authorized parts. It is also a guide for depot maintenance in establishing initial levels of spare parts.

b. Columns are as follows:

- (1) *Source code.* Source, maintenance, and recoverability codes indicate the technical service responsible for supply, the maintenance category where an item is stocked and installed or repaired, and whether an item is repairable or salvageable. The source code column is divided into four parts.
 - (a) *Column A.* This column indicates the materiel code and designates the area of responsibility for supply. AR 310-1 defines the basic numbers used to identify the materiel code. If the part is Signal materiel responsibility, the column is left blank.
 - (b) *Column B.* This column indicates the point within the maintenance system where the part is available. "P" indicates that the repair part is a high mortality part; procured by commodity source, stocked in and supplied from that depot system, and authorized for use at indicated maintenance categories. "P1" indicates that the repair part is a low mortality part; procured by commodity source stocked only in and supplied from commodity source key depots, and authorized for installation at indicated maintenance categories.
 - (c) *Column C.* This column indicates the lowest maintenance category authorized to install the part.

“O”—Organizational maintenance (operator and organizational).

“H”—General support.

(d) *Column D.* Not used.

- (2) *Federal stock number.* This column lists the 11-digit Federal stock number.
- (3) *Designation by model.* The dagger symbol (†) indicates the model where the part is used, and, by its position, designates the quantity used ((7) below), where the quantity varies among models, and the item number ((10) below).
- (4) *Description.* Nomenclature or the standard item name and brief identifying data for each item are listed in this column. When requisitioning, enter the nomenclature and description.
- (5) *Unit of issue.* The unit of issue is each unless otherwise indicated and is the supply term by which the individual item is counted for procurement, storage, requisitioning, allowances, and issue purposes.
- (6) *Expendability.* Nonexpendable items are indicated by NX. Expendable items are not annotated.
- (7) *Quantity in unit.* This column lists the quantity of each part found in a given assembly, component, or equipment.
- (8) *Organizational Maintenance Allowance.* An asterisk (*) indicates that an item is not authorized for stockage, but if required, may be requisitioned for immediate use only.
- (9) *Maintenance allowance.* These columns indicate the quantities of spare parts authorized for initial stockage.
 - (a) *Direct support.* No parts authorized for stockage.
 - (b) *General support.* The numbers in this column indicate the quantities of repair parts authorized for initial stockage for use in general support maintenance. The quantities are based on 100 equipments to be maintained for a 15-day period.
 - (c) *Depot.* The numbers in this column indicate the quantities of repair parts authorized for depot maintenance, for initial stockage for depot maintenance, and for supply support to lower categories. The entries are based on the quantity required for rebuild of 100 equipments.
- (10) *Illustration.* The numbers in the “figure No.” column refer to the illustrations where the part is shown. The “item No.” column lists the reference designations that appear on the part in the equipment; these same designations are used on illustrations of the equipment.

2. Parts for Maintenance

When this equipment is used by signal service organizations organic to the theater headquarters or communication zones to provide theater communications, those repair parts authorized up to and including

general support are authorized for stockage by the organization operating this equipment.

3. Batteries

Dry batteries shown are used with the equipment but are not considered part of the equipment. They will not be preshipped automatically but are to be requisitioned in quantities necessary for the particular organization, in accordance with SB 11-6.

4. Electron Tubes

The consumption rates given for tubes are conservative theoretical estimates and are provided for use only when more complete information, such as data based on operating experience, is not available. These figures are based on levels and requirements for equipment actually in use, not on authorizations or equipment stored in depots.

5. Requisitioning Information (DS, GS, and Depot)

a. The allowance factors are based on 100 equipments. In order to determine the number of parts authorized for initial stockage for the specific number of equipments supported, the following formula will be used and carried out to two decimal places.

$$\text{Specific number of equipments supported} \times \frac{\text{allowance factor}}{100} = \text{number of parts authorized for initial stockage.}$$

b. Fractional values obtained from above computation will be rounded to whole numbers as follows:

- (1) When the total number of parts authorized is less than 0.5, the quantity authorized will be zero.
- (2) When the total number of parts authorized is between 0.5 and 1.0, the quantity authorized will be one.
- (3) For all values above one, fractional values below 0.5 will revert to the next lower whole number and fractional values 0.5 and above will advance to the next higher whole number.
- (4) A parenthesis after the allowance factor listed in the general support column indicates that the item is combat essential and that a minimum quantity of one is authorized for initial stockage even though the computed quantity is less than 0.5

c. The quantities determined in accordance with the above computation represent the initial stockage for a 15-day period.

Section II. ORGANIZATIONAL FUNCTIONAL PARTS LIST

Federal stock No.	Designation by model	Description	Unit of issue	Exp	Qty in unit	Maint org allow.	Illustration	
							Figure No.	Item No.
6665-526-5334		RADIAC SET AN/PDR-27A, AN/PDR-27E						
		RADIAC SET AN/PDR-27A, AN/PDR-27E		NX			1-1	
5355-284-4571		RADIACMETER IM-74A/PDR-27C						
		KNOB: Rogan Bros. P/N RB-41 (range switch)			1	*	1.2	E-106

Section III. GENERAL SUPPORT AND DEPOT FUNCTIONAL PARTS LIST

Source code				Federal stock No.	Designation by model	Description	Unit of issue	Exp	Qty in unit	Maintenance allowance			Illustration	
A	B	C	D							Direct support	General support	Depot	Fig. No.	Item No.
				6665-526-5334		RADIAC SETS AN/PDR-27A, AN/PDR-27E								
						RADIAC SETS AN/ PDR-27A, AN/PDR- 27E: For detecting and measuring rate of received beta and gamma radiations to- gether or gamma radiations alone. Range of detector 0-500 milliroentgens per hour. Scale 0-.5, 0-5, 0-50, 0-500 MR/hr.		NX					1-1	
	P1	H		6665-880-1208		CASE CY-963A,B,C/ PDR-27A			1		0.2	3.0		
						HOLDER, RADIAC SAMPLE: Specialty Electronics dwg num- ber M1-1J.								

RADIACMETER IM-72A/PDR-27C													
P	H	6665-392-7468							1	(0.2)	4.0	1-3	Z101
P	H	5910-280-7037							1	(0.3)	5.0	1-4.1	C105
P	H	5910-666-8075							1	(0.2)	5.0	1-4.1	C106
P	H	5910-636-2134							1	(0.2)	5.0	7-8	C104
P	H	5910-270-9489							1	(0.2)	5.0	1-4.1	C102
P	H	5910-281-0714							1	(0.2)	5.0	1-4.1	C103
P	H	5910-194-8097							2	(0.3)	16.0	7-8	C101 C107

Source code				Federal stock No.	Designation by model	Description	Unit of issue	Exp	Qty in unit	Maintenance allowance			Illustration	
A	B	C	D							Direct support	General support	Depot	Fig. No.	Item No.
	P1	H	---	5340-217-2484	---	CATCH, FASTENER: Admiral part #527A34.	---	---	2	---	0.2	8.0	---	H104 H105
	P1	H	---	4010-141-7642	---	CHAIN: Fed Spec No. RR-C-271, type B.	---	---	1	---	0.2	3.0	---	H101
	P1	H	---	6665-387-7035	---	GASKET: Admiral part #512A21A.	---	---	1	---	0.2	10.0	---	0114
	P1	H	---	6665-387-8054	---	GASKET: Admiral part #512A23.	---	---	1	---	0.2	10.0	---	0111
	P1	H	---	6665-399-7312	---	GASKET: Admiral part #512A22.	---	---	1	---	0.2	10.0	---	0112
	P1	H	---	6665-351-6974	---	GUARD: Admiral part #515A139.	---	---	1	---	0.2	3.0	7-6.1	H204
	P1	O	---	5355-284-4571	---	KNOB: Rogan Bros. part #RB-41.	---	---	1	---	0.2	5.0	1-2	E106
	P	H	---	6240-179-1811	---	LAMP, GLOW J...-54	---	---	2	---	(0.7)	100.0	7-8	E104 E105
	P	H	---	6665-171-9567	---	METER, ROENTGEN RATE: Admiral part #55981.	---	---	1	---	(0.3)	5.0	1-2	M101
	P1	H	---	5310-392-8281	---	NUT, PACKING: Admiral part #520- A15-1-3.	---	---	2	---	0.4	20.0	7-6.1	H102 H201
	P1	H	---	5330-187-3638	---	PACKING, PRE- FORMED: Admiral P/N 512A2-5.	---	---	2	---	0.3	20.0	7-6.1	0201 0202

P1	H	5330-559-1291								PACKING, PRE-FORMED: Non-metallic O-ring, $\frac{5}{32}$ in. ID X $\frac{5}{32}$ in. OD X $\frac{1}{16}$ in. thk, MIL-P-5516, MIL type 6227-2.	2	0.3	20.0		0105
P	H	5950-647-6439								REACTOR-TRANSFORMER: Admiral part #574B4-1.	1	(0.2)	3.0	7-8 7-8.1	L101
P	H	6130-635-6195								RECTIFIER, METALLIC: International Rectifier part #U45HP.	1	(0.2)	5.0	1-4.1	CR101
P	H	5905-195-6761								RESISTOR, FIXED, COMPOSITION: MIL.	2	(0.3)	10.0	7-8	R103 R113
P	H	5905-192-0390								RESISTOR, FIXED, COMPOSITION: MIL type RC20G105J.	1	(0.2)	5.0	7-8 7-8.1	R109
P	H	5905-279-1866								RESISTOR, FIXED, COMPOSITION: MIL type RC20-GF106K.	2	(0.3)	10.0	1-4.1	R102 R114
P	H	5905-239-0583								RESISTOR, FIXED, COMPOSITION: MIL type RC20-GF125K.	1	(0.2)	5.0	1-4.1	R101
P	H	5905-192-0662								RESISTOR, FIXED, COMPOSITION: MIL type RC20-GF184K.	1	(0.2)	5.0	7-8 7-8.1	R105

Source code				Federal stock No.	Designation by model	Description	Unit of issue	Exp	Qty in unit	Maintenance allowance			Illustration	
A	B	C	D							Direct support	General support	Depot	Fig. No.	Item No.
	P	H		5905-279-1875		RESISTOR, FIXED, COMPOSITION: MIL type RC20- GF205J.			1		(0.2)	5.0	1-4.1	R112
	P	H		5905-295-3409		RESISTOR, FIXED, COMPOSITION: MIL type RC20- GF224K.			1		(0.2)	5.0	7-8 7-8.1	R116
	P	H		5905-279-3498		RESISTOR, FIXED, COMPOSITION: MIL type RC20- GF433J.			1		(0.2)	5.0	1-4.1	R111
	P	H		5905-295-3410		RESISTOR, FIXED, COMPOSITION: MIL type RC20- GF473K.			1		(0.2)	5.0	7-8	R117
	P	H		5905-232-2973		RESISTOR, VARI- ABLE: Centralab part Radiohm Model #1, 250,000 ohms, ±20%, 1/10 w.			2		(0.4)	16.0	1-4.1	R104 R108
	P	H		5905-232-2981		RESISTOR, VARI- ABLE: 1.5 meg, ±20%, 1/10 w, Centralab Radiohm Model #1.			1		(0.3)	8.0	1-4.1	R106

P	H	5905-284-3444						RESISTOR, VARIABLE: 3 megohms, $\pm 20\%$, 1/10 w, Centralab Radiohm Model #1.	1	(0.3)	8.0	1-4.1	R110
P1	H	6140-242-9167						RETAINER, BATTERY: Kelley-Koett part #1DC-4789.	1	0.1	3.0		A104
P1	H	5960-273-2448						RETAINER, ELECTRON TUBE: GE part #M-7481731-8.	1	0.1	3.0	1-4.1	0115
P1	H	6665-351-6985						RING: Admiral P/N-527A87.	1	0.1	2.0	7-6.1	0205
P1	H	5340-282-0780						RING, RETAINING: Waldes-Kohinoor part #5133-12.	1	0.1	2.0	1-7	0127
P1	H	5305-206-5278						SCREW, CAPTIVE: Admiral part #501A5-1-52.	6	1.0	60.0		H106
P1	H	5960-322-5394						SHIELD, ELECTRON TUBE: Admiral part #GA170.	1	0.2	10.0		E109
P1	H	6665-171-9416						SHIELD, ELECTRON TUBE: Admiral part #GA168.	1	0.2	10.0	1-5	E110
P1	H	6665-663-8124						SHIELD, RADIAC DETECTOR: Admiral P/N GA-158-1.	1	0.2	10.0	7-6.1	0206
P	H	5935-96-8430						SOCKET, ELECTRON TUBE: Eby type #8323.	2	(0.3)	10.0	7-8.1	XV-103 XV-104

Source code				Federal stock No.	Designation by model	Description	Unit of issue	Exp	Qty in unit	Maintenance allowance			Illustration	
A	B	C	D							Direct support	General support	Depot	Fig. No.	Item No.
	P	H		5935-201-3191		SOCKET, ELECTRON TUBE: Amphenol part #77-M1P-11TM.			1		(0.2)	5.0		X201
	P1	H		5940-151-4035		CLIP, ELECTRICAL: Littlefuse part #123002.			1		0.2	4.0		0109
	P1	H		6665-500-5409		CLIP, ELECTRICAL: Admiral part #590A3-2.			1		0.2	4.0	1-4.1	0116
	P1	H		5940-242-4955		CLIP, ELECTRICAL: Millen Mfg Co part #36021.			1		0.2	4.0		0117
	P1	H		5940-351-3660		CLIP, ELECTRICAL: Admiral part #590A1-2.			1		0.2	4.0	7-6.1	0207
	P	H		5935-237-6663		CONNECTOR, PLUG, ELECTRICAL: Eby part #9706-3.			2		(0.3)	10.0		P101 P102
	P	H		5935-201-3511		CONNECTOR, RE- CEPTACLE, ELEC- TRICAL: Type UG- 290A/U.			1		(0.2)	5.0		J101
	P1	H		6665-351-6977		COVER: Admiral part #520CS-2.			1		0.1	3.0		A103
	P1	H		5935-258-1767		COVER, ELECTRICAL CONNECTOR: Type CW-123A/U.			1		0.1	3.0		0121

P	H	6665-243-4081					DETECTOR, RADIAC DT-53/PDR-27.	NX	1	(0.2)	4.0	7-6	
P	H	6665-515-5891					DETECTOR, RADIAC DT-53B/PDR-27.	NX	1	(0.2)	4.0		
P	H	5960-686-9101					ELECTRON TUBE: MIL type 5979, Navy type BS-1.		1	(2.0)	100.0	7-6 7-6.1	V102
P	H	5960-296-1640					ELECTRON TUBE: Jan type 5980, Navy type BS-2.		1	(2.0)	100.0	1-3 1-4.1	V101
P	H	5960-188-6592					ELECTRON TUBE: MIL type 5962.		1	(8.0)	100.0	1-4 1-4.1	V103
P	H	5960-188-3524					ELECTRON TUBE: MIL type 3V4.		1	(4.0)	100.0	1-4 1-4.1	V104
P1	H	5330-298-6534					GASKET: Admiral part #512A1-15.		1	0.2	10.0		0128
P1	H	5330-260-9311					GASKET: ANA type #AN-6227B-5.		1	0.2	10.0		0140
P1	H	6665-392-7477					SPRING: Admiral part #GA323.		1	0.2	5.0	1-7	0124
P1	H	6665-664-2131					SPRING, HELICAL EXTENSION: Admiral part #519B12.		1	0.2	5.0		0103
P1	H	6665-288-2272					SPROCKET, WHEEL: Boston Gear Wks part #CBA-12MOD, Admiral part #530A4-1.		2	0.2	4.0		0101
P	H	5930-327-8387					SWITCH, MERCURY: Admiral part #577A1.		1	(0.3)	7.0	1-4.1	S102
P	H	5930-548-4616					SWITCH, ROTARY: Oak part #42065-F3.		1	(0.3)	7.0	1-4.1	S101

Source code				Federal stock No.	Designation by model	Description	Unit of issue	Exp	Qty in unit	Maintenance allowance			Illustration	
A	B	C	D							Direct support	General support	Depot	Fig. No.	Item No.
	P	H		5930-636-0210		SWITCH, SENSITIVE: SPST, Acro part #Q6340.			1	(0.3)	7.0	1-7	S103 S102	
	P	H		5930-636-2587		SWITCH SECTION, ROTARY: Oak part #28601-HC5.			1	(0.3)	7.0	1-4.1	S101A	
	P	H		5930-173-8347		SWITCH SECTION, ROTARY: Admiral part #576B5-6.			1	(0.3)	7.0	1-4.1	S101B	
	P	H		5930-173-8351		SWITCH SECTION, ROTARY: Admiral part #576B5-7.			1	(0.3)	7.0	1-4.1	S101C	
	P1	H		5940-227-7182		TERMINAL BOARD: Cinch Mfg Co part #19F16780.			1	0.2	5.0	1-4.1	E101	
	P1	H		5310-523-5908		WASHER, FLAT: Kelley-Koett part #1DA-4781-1.			1	0.3	10.0		H103	
	P1	H		5330-393-2076		WASHER, NON- METALLIC: Admiral part #512A19.			2	0.4	20.0		0118 0203	
	P1	H		5330-641-3012		WASHER, NON- METALLIC: May- fair part #2386.			3	0.8	30.0			

P1	H		5330-298-0678							WASHER, NON-METALLIC: Rubatex part #R-203P.			1		0.3	10.0	1-7	0125
----	---	--	---------------	--	--	--	--	--	--	---	--	--	---	--	-----	------	-----	------

Add the glossary (as added by C 3, 8 Feb 1962):

GLOSSARY

Alpha particle—A particle emitted spontaneously from the nuclei of some radioactive elements. It has a mass of four units and an electrical charge of two positive units.

Beta particle—A charged particle of very small mass emitted spontaneously from the nuclei of some radioactive elements. Physically, the beta particle is identical with an electron moving at high velocity.

Curi—A unit of radioactivity; it is the quantity of any radioactive material in which 3.700×10^{10} nuclear disintegrations occur each second.

Gamma ray—An electromagnetic radiation of high energy originating in atomic nuclei and accompanying many nuclear reactions. Except for the method of production, gamma rays are identical physically with high energy X-rays.

Intensity—The energy (of any radiation) incident upon (or flowing through) a unit area, perpendicular to the radiation beam, in unit time. In relation to nuclear radiation, the term, intensity, is sometimes used to express the exposure dose rate in roentgens or milliroentgens per hour.

Isotopes—Multiple forms of an element, which have identical chemical properties but different atomic masses and nuclear properties.

Millicuri—One-thousandth of a curi. (See curi.)

Microcuri—One-millionth of a curi. (See curi.)

Milliroentgen—One-thousandth of a roentgen. (See roentgen.)

Radioactivity—The spontaneous emission of radiation, generally alpha or beta particles, often accompanied by gamma rays, from the nuclei of unstable isotopes.

Roentgen—A unit of exposure dose of gamma radiation. One roentgen is the amount of radiation that produces, in one cubic centimeter of dry air, ionization equal to one electrostatic unit of charge (negative or positive).

Shielding—Any material or obstruction that absorbs radiation and thus tends to protect personnel (or materials) from the effects of radiation.

By Order of the Secretary of the Army:

HAROLD K. JOHNSON,
General, United States Army,
Chief of Staff.

Official:

J. C. LAMBERT,
Major General, United States Army,
The Adjutant General.

Distribution:

Active Army:

USASA (2)
CNGB (1)
OCC-E (7)
Dir of Trans (1)
CofEngrs (1)
TSG (1)
CofSptS (1)
USAARMBD (2)
USAARTYBD (2)
USACDCEA (1)
USACDCCBRA (1)
USACDCCEA (1)
USACDCOA (1)
USACDCQMA (1)
USACDCTA (1)
USACDCDA (1)
USACDCARMA (1)
USACDCAVNA (1)
USACDCARTYA (1)
USACDCSWA (1)
USACDCCEA
 Ft Huachuca (1)
USAMC (5)
USCONARC (5)
ARADCOM (5)
ARADCOM Rgn (2)
OS Maj Comd (4)
LOGCOMD (2)
USAMICOM (4)
USASMC (2)
USASCC (4)
USAECOM (30)
USASPTCP (11)
MDW (1)
Armies (2) except
 Third (5)
 EUSA (5)
Corps (2)
USAC (3)
11th Air Aslt Div (3)
Svc Colleges (2)
Br Svc Sch (2) except
 USACMLCS (5)

MFSS (5)
USAOGMS (5)
USAQMS (5)
USAFS (5)
USAARMS (5)
USASESCS (40)
USMA (40)
USATC Armor (2)
USATC Engr (2)
USATC Inf (2)
USASTC (2)
WRAMC (1)
Army Pic Cen (2)
Instl (2) except
 Fort Monmouth (70)
 Fort Hancock (4)
 Fort Gordon (10)
 Fort Huachuca (10)
 WSMR (5)
 Fort Carson (25)
 DPG (5)
 JPG (5)
Army Dep (2) except
 SAAD (30)
 TOAD (14)
 FTWOAD (10)
 LEAD (7)
 SHAD (3)
 NAAD (5)
 SVAD (5)
 CHAD (3)
 ATAD (10)
 LBAD (14)
GENDEPS (2)
Sig Sec, GENDEPS (5)
Sig Dep (12)
Army Tmls (1) except
 WBGH (5)
 AMS (1)
 USAERDAA (2)
 USAERDAW (13)
Sig Fld Maint Shops (2)

Units org under fol TOE's (2 cys ea UNOINDC):

3-7	8-122
3-47	8-127
3-500 (Tms AA-AC)	8-128
3-510	8-137
5-5	8-147
5-6	8-167
5-15	8-187
5-16	8-204
5-25	8-500 (Tms AA-AH)
5-26	8-510
5-38	8-551
5-115	8-563
5-116	8-565
5-127	8-566
5-137	8-567
5-145	8-571
5-146	8-581
5-155	8-650
5-156	8-667
5-225	9-12
5-226	9-22
5-500 (Tms AA-AD)	9-47
5-600	9-65
5-601	9-67
6-100	9-87
6-101	9-227
6-300	9-377
6-301	9-500 (Tms AA-AC)
6-302	9-510
6-401	10-7
6-501	10-17
7	10-37
7-2	10-45
7-3	10-47
7-4	10-48
7-25	10-105
7-26	10-107
7-31	10-349
7-32	10-445
7-35	10-447
7-42	10-467
7-52	10-500 (Tms AA-AD)
7-100	11-16
7-102	11-32
8-15	11-57
8-16	11-97
8-35	11-98
8-36	11-117
8-37	11-155
8-65	11-157
8-66	11-337
8-67	11-500 (Tms AA-AE) (4)
8-75	11-587
8-76	11-592

Units org under fol TOE's (2 cys ea UNOINDC)—Continued

11-597	29-46
12-52	29-51
17	29-56
17-2	29-65
17-4	29-75
17-15	29-105
17-16	29-307
17-25	29-311
17-26	30-600 (Tms AA-AE)
17-32	37
17-35	37-4
17-36	37-42
17-42	37-100
17-45	37-102
17-46	39-51
17-51	39-62
17-52	39-401
17-55	41-2
17-56	41-500 (Tms AA, AB)
17-65	44-2
17-66	44-12
17-75	44-235
17-76	44-236
17-85	44-500 (Tms AA, AB)
17-86	44-544
17-100	44-545
17-102	44-546
17-105	44-547
17-106	44-548
17-135	44-568
17-136	51-2
29-1	52-2
29-6	55-157
29-7	55-202
29-11	55-302
29-15	57
29-17	57-4
29-21	57-6
29-25	57-42
29-27	57-100
29-45	57-102

NG: State AG (3); units—same as active Army except allowance is one copy to each unit.

USAR: None.

For explanation of abbreviations used see AR 320-50.

Changes in force: C 1, C 4, C 5, and C 6

TM 11-5543

C 6

CHANGE }
No. 6 }

HEADQUARTERS
DEPARTMENT OF THE ARMY
WASHINGTON, D.C., 16 April 1968

**RADIAC SETS AN/PDR-27A, AN/PDR-27C, AND
AN/PDR-27E INCLUDING REPAIR PARTS AND
SPECIAL TOOL LISTS**

TM 11-5543, August 1952, is changed as follows:
The title is changed as shown above.

Note. The parenthetical reference to previous changes (*example:* page 4 of C 5) indicates that pertinent material was published in that change. *Inside front cover* (page 1 of C 5, 23 Sep 65). Delete the warning notice and substitute:

**WARNING!
RADIATION HAZARD**

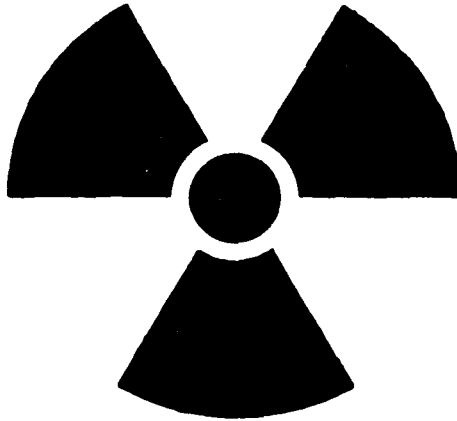

STD-RW-2

Co 60 or RA 226

Radioactive Test Sample MX-1083/PDR-27 contains the equivalent of 5 microcuries of cobalt 60; Radioactive Test Sample MX-1083B/PDR-27 contains 7 micrograms of radium. Be extremely careful while using these test samples, and follow safe procedures for handling, storage, and disposal (AR 700-52, AR 755-15, TB 3-6665-200-12, and TB 3-6665-201-12).

Change DA Pam 310-4 to DA Pam 310-7 in the following places:

Page 3-1, section 3, paragraph 1, step 5 (page 2 of C 4, 26 Feb 63), *note*.

Page 6-0, section 6, paragraph 5 (page 7 of C 4, 26 Feb 63), chart. Item No. 3, in the *Item* column.

Paragraph 7 (page 9 of C 4, 26 Feb 63), chart. Item No. 3, in the *Item* column.

Page 8-22, section 9, paragraph 2b (page 3 of 3 of C 5, 23 Sep 65), line 3.

Add or AN/UDM-1A after AN/UDM-1 in the following places:

Page 7-8, section 7, paragraph 6a (page 19 of C 1, 3 Feb 55), line 2.

Page 8-22, section 9, paragraph 3a (page 3 of C 5, 23 Sep 65).

Paragraph 8 (page 5 of C 5, 23 Sep 65), line 3 of *note* and lines 3 and 5 of paragraph.

Page III. Delete the destruction proceedings in their entirety.

Page 1-1. Delete paragraphs 1.1 and 1.2 (page 2 of C 5, 23 Sep 65) and substitute:

1.1 Indexes of Equipment Publications

a. DA Pam 310-4. Refer to the latest issue of DA Pam 310-4 to determine whether there are new editions, changes, or additional publications pertaining to the equipment.

b. DA Pam 310-7. Refer to the latest issue of DA Pam 310-7 to determine whether there are modification work orders (MWO'S) pertaining to the equipment.

1.2 Forms and Records

a. Reports of Maintenance and Unsatisfactory Equipment. Use equipment forms and records in accordance with instructions in TM 38-750.

b. Reporting of Packaging and Handling Deficiencies. Fill out and forward DD Form 6 (Report of Packaging and Handling Deficiencies) as prescribed in AR 700-58 (Army), NAVSUP Publication 378 (Navy), AFR 71-4 (Air Force), and MCO P4610-5 (Marine Corps).

c. Discrepancy in Shipment Report (DISREP) (SF 361). Fill out and forward Discrepancy in Shipment Report (DISREP) (SF 361) as prescribed in AR 55-38 (Army), NAVSUP Pub 459 (Navy), AFM 75-34 (Air Force), and MCO P4610.19 (Marine Corps).

d. Report of Equipment Manual Improvements. Report of errors, omissions, and recommendations for improving this manual by the individual user is encouraged. Reports should be submitted on DA Form 2028 (Recommended Changes to DA Publications) and forwarded direct to Commanding General, U.S. Army

Electronics Command, ATTN: AMSEL-ME-NMP-AD, Fort Monmouth, N.J. 07703.

Page 3-2, section 3, paragraph 3 (page 11 of C 1, 3 Feb 55). Make the following changes:

In the *note*, delete the last sentence.

Page 3-2, section 3, paragraph 3, step 5, line 5. Delete 15 to 30 mr/hr and substitute: within the scale limits.

Step 6, line 5. Delete 12 to 22 mr/hr and substitute: within the scale limits.

Step 7, line 4. Delete 1.5 to 2.5 mr/hr and substitute: within the scale limits.

Step 8, line 5. Delete 0.18 to 0.30 mr/hr and substitute: within the scale limits.

Table 3-1 (page 12 of C 1, 3 Feb 55). Delete table 3-1.

Page 4-3, section 4, paragraph 5g. Delete the CAUTION notice and substitute:

Caution: The batteries must be removed if the equipment is being placed in storage or in a standby condition. Any deviation, to meet a particular situation, must be authorized by the individual commander.

Page 6-0, section 6. Make the following changes:

Paragraph 5 (page 7 of C 4, 26 Feb 63), chart. In the "Item" column, after item No. 8 add the following:

Caution: The batteries must be removed if the equipment is in storage or in a standby condition.

Paragraph 7 (page 10 of C 4, 26 Feb 63), chart. In the "Item" column, after item No. 8, add the following:

Caution: The batteries must be removed if the equipment is in storage or in a standby condition.

After item No. 9, add:

<i>Item No.</i>	<i>Item</i>	<i>Procedure</i>	
		<i>Normal condition or result</i>	<i>Reference</i>
1 0	TEST SAMPLE . . .	Test sample has identification tag and meets minimum leakage requirements as determined by wipe test.	Sec 6, para 9.

Wipe

After paragraph 8 (page 11 of C 4, 26 Feb 63), add:

9. Wipe Test

The purpose of the wipe test is to detect radioactive contamination (leakage) of the test sample. This test must be performed semi-

annually under the direct supervision of the Radiological Protection Officer. To perform the wipe test, refer to TB 3-6665-200-12 (MX-1083/PDR-27) or to TB 3-6665-201-12 (MX-1083B/PDR-27).

Note. In addition to the wipe test procedures, TB 3-6665-200-12 and TB 3-6665-201-12 also contain data pertaining to inspection, tagging, handling, and storing of test samples.

Page 7-8, section 7, paragraph 6 (page 2 of C 5, 23 Sep 65).

Delete the paragraph heading and substitute: 6. Depot Calibration

Page 8-22, section 9 (page 3 of C 5, 23 Sep 65). Make the following changes:

Paragraph 4b (page 3 of C 5, 23 Sep 65), line 1. Change 15 minutes to 5 minutes.

Paragraph 8 (page 5 of C 5, 23 Sep 65), lines 3 and 5 of *note* and line 5 of paragraph. Change TM 11-1176 to TM 11-1176 or TM 11-6665-217-15.

Add section 10 after section 9:

SECTION 10 DEMOLITION OF MATERIEL TO PREVENT ENEMY USE

1. Authority for Demolition

The demolition procedures given in paragraph 2 will be used to prevent the enemy from using or salvaging this equipment. Demolition of the equipment will be accomplished only upon the order of the commander.

2. Methods of Destruction

a. Smash. Use sledges, axes, hammers, crowbars, and any other heavy tools available to smash the interior units of the sets.

(1) Remove the cover from the case casting and remove the batteries.

(2) Use the heaviest tool available to smash the dial, knobs, batteries, and tubes, and smash as many of the exposed parts of the cover as possible.

Warning: Be extremely careful with explosives and incendiary devices. Use these items only when the need is urgent.

b. Burn. Burn the technical manuals first. Burn as much of the equipment as is flammable; use gasoline, oil, flamethrowers, and similar materials. Pour gasoline on the internal wiring and ignite it. Use a flamethrower to burn spare parts, or pour gasoline on the spares and ignite them. Use incendiary grenades to complete the destruction of the set.

c. Dispose. Bury or scatter destroyed parts or throw them into nearby waterways. This is particularly important if a number of parts have not been completely destroyed.

3. Handling and Disposal of Radioactive Material

Warning: Follow the procedures for safe handling and disposal of radioactive materials as directed in *a* through *e* below.

- a.* TB SIG 225.
- b.* AR 700-52.
- c.* AR 755-15.
- d.* TB 3-6665-200-12.
- e.* TB 3-6665-201-12.

Appendix I (page 5 of C 5, 23 Sep 65). Delete the appendix and substitute:

APPENDIX I REFERENCES

Following is a list of applicable references available to the operator maintenance and personnel of Radiac Sets AN/PDR-27A, AN/PDR-27C, and AN/PDR-27E,

AR 700-52	Licensing and Control of Sources of Ionizing Radiation
AR 755-15	Disposal of Unwanted Radioactive Material
DA Pam 310-4	Index of Technical Manuals, Technical Bulletins, Supply Manuals (types 7, 8, and 9), Supply Bulletins, and Lubrication Orders
DA Pam 310-7	U.S. Army Equipment Index of Modification Work Orders
SB 11-6	Dry Battery Supply Data
TB SIG 225	Identification and Handling of Radioactive Signal Items
TB SIG 355-1	Depot Inspection Standard for Repaired Signal Equipment
TB SIG 355-2	Depot Inspection Standard for Refinishing Repaired Signal Equipment
TB SIG 355-3	Depot Inspection Standard for Moisture and Fungus Resistant Treatment
TB SIG 364	Field Instructions for Painting and Preserving Electronics Command Equipment
TB 3-6665-200-12	Radioactive Test Sample, Cobalt 60, Gamma, MX-1083/PDR-27
TB 3-6665-201-12	Radioactive Test Sample, Radium 226, Gamma, MX-1083B/PDR-27
TM 11-1176	Radiac Calibrator Set AN/UDM-1
TM 11-1214	Instruction Book for Oscilloscope OS-8A/U.
TM 11-6625-274-12	Operator's and Organizational Maintenance Manual: Test Sets, Electron Tube TV-7/U, TV-7A/U, TV-7B/U, and TV-7D/U
TM 11-6625-316-12	Operator and Organizational Maintenance Manual: Test Sets, Electron Tube TV-2/U, TV-2A/U, TV-2B/U, and TV-2C/U

TM 11-6625-366-15 Organizational, DS, GS, and Depot Maintenance Manual: Multimeter TS-352B/U

TM 11-6625-539-15 Operator, Organizational, Field and Depot Maintenance Manual: Test Sets, Transistor TS-1836/U

TM 11-6665-204-12 Operator and Organizational Maintenance Manual: Calibrator Sets, Radiac TS-784/PD and TS-784A/PD

TM 11-6665-217-15 Organizational, DS, GS, and Depot Maintenance Manual: Radiac Calibrator Set AN/UDM-1A

TM 38-750 Army Equipment Record Procedures

By Order of the Secretary of the Army:

HAROLD K. JOHNSON,
General, United States Army,
Chief of Staff.

Official:

KENNETH G. WICKHAM,
Major General, United States Army,
The Adjutant General.

Distribution:

To be distributed in accordance with DA Form 12-50 requirements for Organizational maintenance, Radiac Sets AN/PDR-27A, AN/PDR-27C and AN/PDR-27E.

DEPARTMENT OF THE ARMY TECHNICAL MANUAL
TM 11-5543

RADIAC
SET
AN/PDR-27

DEPARTMENT OF THE ARMY • AUGUST 1952

United States Government Printing Office
Washington : 1952

DEPARTMENT OF THE ARMY
WASHINGTON 25, D.C., 22 August 1952

TM 11-5543 is published for the information and guidance of all concerned.

[AG 413.44 (30 Jul 52)]

BY ORDER OF THE SECRETARY OF THE ARMY:

OFFICIAL:

WM. E. BERGIN
Major General, USA
The Adjutant General

J. LAWTON COLLINS
Chief of Staff, United States Army

DISTRIBUTION:

Active Army:

Tech Svc (1) ; Tech Svc Bd (1) ; AFF Bd (ea Svc Test Sec) (1) ; AFF (5) ; AA Comd (2) ; OS Maj Comd (5) ; Base Comd (5) ; Log Comd (5) ; A (20) ; MDW (5) ; CHQ (2) ; FT (2) ; Sch (5) except 11 (25) ; Gen Dep (2) ; Dep 11 (20) except Sig Sec, Gen Dep (10) ; Tng Div (2) ; POE (10) ; OSD (2) ; Lab 11 (5) ; Mil Dist (3) ; 4th & 5th Ech Maint Shops 11 (3) ; Two (2) copies to each of the following T/O & E's: 11-107 ; 11-127A ; 11-128 ; 11-500, CA, CB, CC, CD ; 11-587 ; 11-592 ; 11-597.

NG: Same as Active Army except one copy to each unit.

ORC: Same as Active Army except one copy to each unit.

For explanation of distribution formula, see SR 310-90-1.

This manual is a reprint of Department of the Navy manual NAVSHIPS 91424(A), Radiac Set AN/PDR-27A, 20 March 1951, published for use within the Department of the Army by permission of the Department of the Navy.

TABLE OF CONTENTS

SECTION 1-GENERAL DESCRIPTION

Paragraph		Page
1.	Purpose and Basic Principles	1-1
2.	Description of Units	1-2
3.	Reference Data	1-9

SECTION 2-THEORY OF OPERATION

1.	Radioactivity and its Detection	2-1
2.	General Circuit Description	2-3
3.	Circuit Analysis	2-4

SECTION 3-INSTALLATION

1.	Unpacking	3-1
2.	Installation	3-1
3.	Initial Testing	3-2

SECTION 4-OPERATION

1.	General	4-1
2.	Starting the Equipment.	4-1
3.	Radiation Detection and Measurement.	4-1
4.	Stopping the Equipment	4-3
5.	Summary of Operation	4-3

SECTION 5-OPERATOR'S MAINTENANCE

1.	Routine Checks	5-0
2.	Emergency Maintenance.	5-1

TABLE OF CONTENTS (cont.)

SECTION 6-PREVENTIVE MAINTENANCE

Paragraph		Page
1.	General	6-0
2.	Routine Maintenance Check Chart.	6-0
3.	Re-tropicalization	6-0

SECTION 7-CORRECTIVE MAINTENANCE

1.	General	7-1
2.	Theory of Localization.	7-1
3.	Voltage-Resistance Chart.	7-2
4.	Waveform Chart	7-8
5.	Trouble Shooting Chart	7-8
6.	Calibration	7-8
7.	Removal and Replacement of Parts	7-12
8.	Component Characteristics.	7-14

SECTION 8-PARTS LISTS

DESTRUCTION OF ABANDONED MATERIAL IN THE COMBAT ZONE

In case it should become necessary to prevent the capture of this equipment, and when ordered to do so, DESTROY IT SO THAT NO PART OF IT CAN BE SALVAGED, RECOGNIZED, OR USED BY THE ENEMY. BURN ALL PAPERS AND BOOKS.

Means:

1. Explosives when provided.
2. Hammers, axes, sledges, machetes, or whatever heavy object is readily available.
3. Burning by means of incendiaries such as gasoline, oil, paper or wood.
4. Grenades and shots from available firearms.
5. Burying all debris where possible and when time permits.
6. Throwing overboard or disposing of in streams or other bodies of water.

Procedure:

1. Obliterate all identifying marks. Destroy nameplates and circuit labels.
2. Demolish all panels, castings, switch and instrument boards.

3. Destroy all controls, switches, relays, connections, and meters.
4. Rip out all wiring and cut interconnections of electrical equipment. Smash gas, oil and water cooling systems in gas engine generators, etc.
5. Smash every electrical or mechanical part, whether rotating, moving or fixed.
6. Break up all, operating instruments such as keys, phones, microphones, etc.
7. Destroy all classes of carrying cases, straps, containers, etc.
8. Bury or scatter all debris.

DESTROY EVERYTHING!

SAFETY NOTICE

WARNING

The attention of officers and operating personnel is directed to Chapter 67 of the Bureau of Ships Manual or superseding instructions on the subject of radio-safety precautions to be observed.

This equipment employs voltages which are dangerous and may be fatal if contacted by operating personnel. Extreme caution should be exercised when working with the equipment.

While every practicable safety precaution has been incorporated in this equipment, the following rules must be strictly observed:

RADIOLOGICAL SAFETY WARNING:

All personnel working in high-intensity levels of radioactivity must exercise caution to prevent bodily damage. While the radiation from radioactive substances usually cannot be seen or felt, prolonged or intensive exposure may result in serious damage. Three tenths of a roentgen per week (.3R/wk) is considered to be the maximum amount of such radiation which can be absorbed continuously, each week as a peace time tolerance dose.

When using the radioactive source required for calibration of this equipment, exercise due care in handling it. The safety instructions enclosed herein, and with the source, must be closely followed.

KEEP AWAY FROM LIVE CIRCUITS:

Operating personnel must at all times observe all safety regulations. Do not change tubes or make adjustments inside equipment with high voltage supply on. Under certain conditions dangerous potentials may exist in circuits with power controls in the off position due to charges retained by capacitors. To avoid casualties, always remove power and discharge and ground circuits prior to touching them.

DON'T SERVICE OR ADJUST ALONE:

Under no circumstances should any person reach within or enter the enclosure for the purpose of servicing or adjusting the equipment without the immediate presence or assistance of another person capable of rendering aid.

RESUSCITATION

AN APPROVED POSTER ILLUSTRATING THE RULES FOR RESUSCITATION BY THE PRONE PRESSURE METHOD SHALL BE PROMINENTLY DISPLAYED IN EACH RADIO, RADAR, RADIAC, OR SONAR ENCLOSURE. POSTERS MAY BE OBTAINED UPON REQUEST TO THE BUREAU OF MEDICINE AND SURGERY.

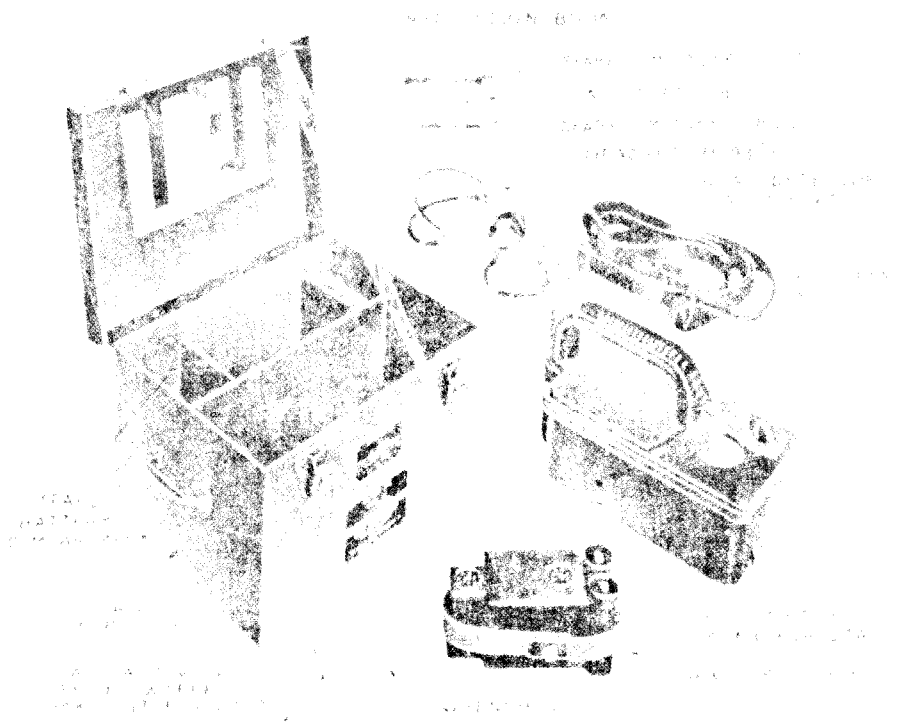

Figure 1-1. Radiac Set AN/PDR-27A

SECTION 1 GENERAL DESCRIPTION

1. PURPOSE AND BASIC PRINCIPLES.

Radiac Set AN/PDR-27A is a portable, watertight, battery-operated radiation detector and indicator. It is capable of detecting and measuring beta and gamma radiations together, or gamma radiations alone. Radiacmeter IM-63/PDR-27A is the main unit of the radiac set, and is equipped with a carrying handle, or may be carried by an externally connected shoulder harness. Radiac Detector DT-53/PDR-27 is a probe attached externally, by means of a self-retracting cable, to the radiacmeter. The detector is normally carried in an external well on the radiacmeter and can be easily removed. When measuring gamma radiation, the detector can be used in or out of the well; beta radiations, however, can only be detected when the detector is removed from the well and the beta shield on the probe is moved aside. The radiacmeter also houses an electronic chassis, an indicating meter, and dry batteries. Case CY-963/PDR-27A is a light-weight carrying case which houses the detector, Radioactive Test Sample MX-1083/PDR-27, Headset H-43/U, Harness ST-119/PDR-27 spare tubes, spare batteries, a wrench, and instruction books.

Geiger-Mueller tubes (G-M) are used in the radiac set to detect gamma and beta radiations. When the G-M tubes are exposed to such radiations, they produce short-duration d-c voltage pulses whose average repetition rate is proportional to the average radiation field intensity in the vicinity of the G-M tubes. Visual indication is provided by a meter reading proportional to the pulse reception rate; aural indication is provided by headphones in which a click is heard for each received pulse.

The range of field intensities capable of being detected by the radiac set is relatively broad. Therefore, in order to provide an easily observable meter deflection for any value of field intensity within the operating range of the set, four ranges of sensitivity are provided. Any one range may be selected by means of a switch on the radiacmeter panel. The two most sensitive ranges utilize a Navy type BS-1 G-M tube, which is contained in the probe. This tube has a mica end-window covered by a removable metal beta shield. The shield can be displaced for beta-plus-gamma radiation readings, and is left in place for gamma radiation readings alone. The two less sensitive ranges utilize a Navy type BS-2 G-M tube, which is contained inside the radiacmeter housing. Only gamma radiation field strength can be measured on these two less sensitive ranges.

2. DESCRIPTION OF UNITS (See tables 1-1 and 1-2).

Radiac Set AN/PDR-27A consists of the components listed in tables 1-1 and 1-2.

a. CASE CY-963/PDR-27A. The carrying case houses all other radiac set units. It is equipped with carrying handles and hasps, is fabricated from sheet aluminum, and is so constructed that it can be completely disassembled for decontamination. A spare parts compartment is provided in the case.

b. RADIACMETER IM-63/PDR-27A. The radiacmeter consists of three castings which comprise the handle, the battery compartment, the waterproof enclosure, and space for the electronic chassis. The handle is cast integrally with a plate which serves as a water-tight cover for the battery compartment. The panel casting provides the means for mounting the electronic chassis, meter, range switch, phone jack, and a compartment for the batteries. The remaining casting completes the waterproof enclosure and provides a well at one end to hold the detector probe. All joints between castings are made watertight by the use of rubber "O" ring gaskets and screws to draw the joints tight.

The indicating meter is of the scale changing type and is connected to the range switch by means of ladder chain and sprockets with the result that the meter is direct reading on all ranges.

TABLE 1-1. EQUIPMENT SUPPLIED

Quantity per Equipment	Name of Unit	Navy Type Designation	OVER-ALL DIMENSIONS			Volume	Weight
			Height	Width	Length		
1	Case	CY-963/PDR-27A	9-1/2"	15"	10-5/8"	1335 cu. in.	28**
1	Radiacmeter	IM-63/PDR-27A	8"	5-7/8"	12-3/8"		14-1/8*
1	Radiac Detector	DT-53/PDR-27		1-3/8" O. D.	7-13/16"	11.5 cu. in.	.87
1	Headset	H-43/U					.7
1	Harness	ST-119/PDR-27					1.2
1	Radioactive Test Sample	MX-1083/PDR-27	3/8" O. D.		5"	.6 cu. in.	.03
1	Wrench		.075"	1-1/16"	4"		
2	Instruction Books for Radiac Set AN/PDR-27A						
1	Tube (spare)	BS-101		3/4" O. D.	2-3/4"		.05
1	Tube (spare)	BS-1		1-1/4" O. D.	7"		.17
1	Tube (spare)	BS-2		3/8" O. D.	4"		.02

Dimensions are inches, volume cubic inches, weight pounds.

* Including Handle and with Batteries.

** Fully packed including operating and spare batteries.

TABLE 1-2. EQUIPMENT REQUIRED BUT NOT SUPPLIED

Quantity per Equipment	Name of Unit	Standard Navy Stock No.	Required Use
2	Batteries BA-416/U	N17-B-60513-9657	1 for operating use 1 for spare
2	Batteries BA-413/U	N17-B-59196-1685	1 for operating use 1 for spare
4	Batteries BA-401/U	N17-B-58747-3197	2 for operating use 2 for spare

ORIGINAL

GENERAL
DESCRIPTION

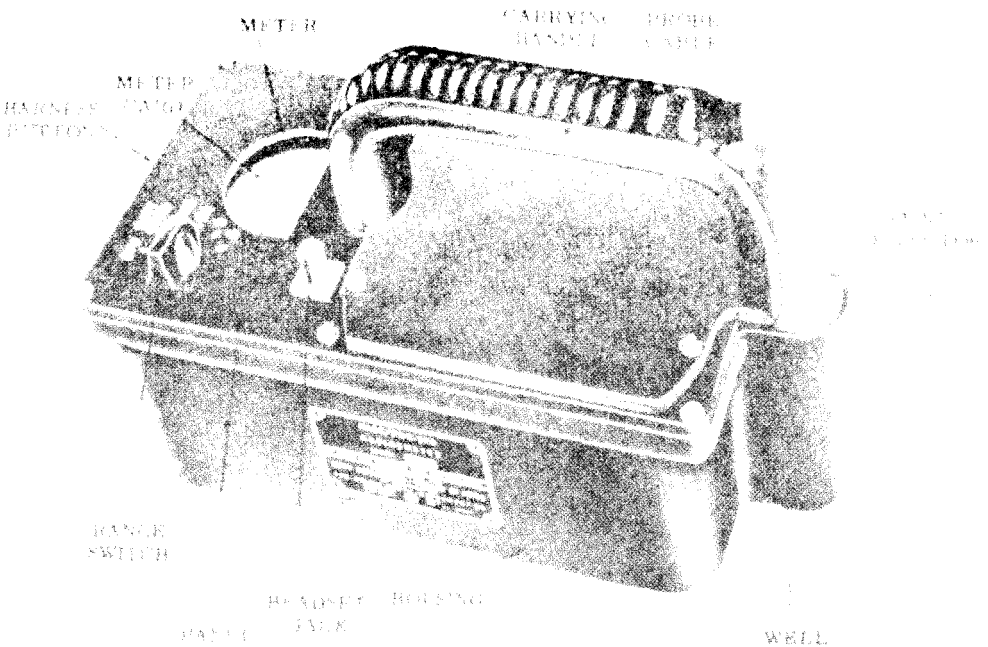

Figure 1-2. Radiacmeter IM-63/PDR-27A, Front View

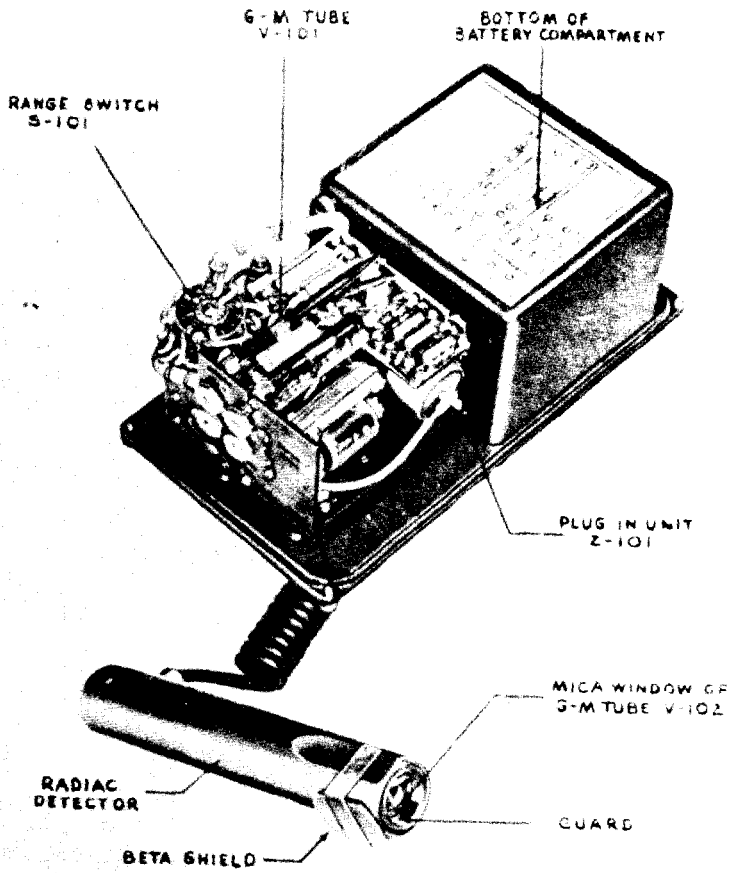

Figure 1-3. Radiacmeter IM-63/PDR-27A, Inside View

The battery power is conveyed to the electronic chassis thru the wall of the battery compartment by means of a waterproof feed-through, eight lug, terminal strip. The two single cell filament batteries are mounted in a special molded plastic holder to facilitate battery changing and provide a method for making contact to these batteries. Connection is made to the other batteries by means of two octal plugs.

The handle for the radiacmeter is constructed so as to allow space for the extensible cable which leads to the radiac detector probe.

c. RADIAC DETECTOR DT-53/PDR-27. The radiac detector is a water-proof metal housing for a Navy type BS-1 G-M tube. The housing is closed at the cable end by a threaded plug with an "O" ring gasket, at the other end a threaded ring bears against the GM tube body to hold the tube in place but leaves the mica window exposed. The G-M tube is supported at the mica window end by means of this threaded ring and "O" ring gasket. The flexible cable enters the side of the housing, at the closed end of the probe, through a waterproof packing gland. A spring retained metal shield covers the mica window of the G-M tube. When this shield is in place, beta radiation is prevented from entering the G-M tube. If this shield is swung aside both beta and gamma radiation can be detected.

CAUTION

Since the mica window is only 0.0005 inch thick, it is extremely fragile. Do not touch the window under any circumstances, as damage to the tube will result. Do not rely on the guard to protect the mica window; the guard openings are large enough so that sharp objects can pass through and pierce the window.

d. HEADSET H-43/U. The headset provides the operator with aural indications of radiation intensity when plugged into the jack on the radiacmeter front panel.

e. HARNESS ST-119/PDR-27. The shoulder harness, an adjustable strap made of a non-absorbent plastic, is used for carrying the radiacmeter and probe during operation. Metal clips on the harness fasten to harness buttons secured to the radiacmeter housing.

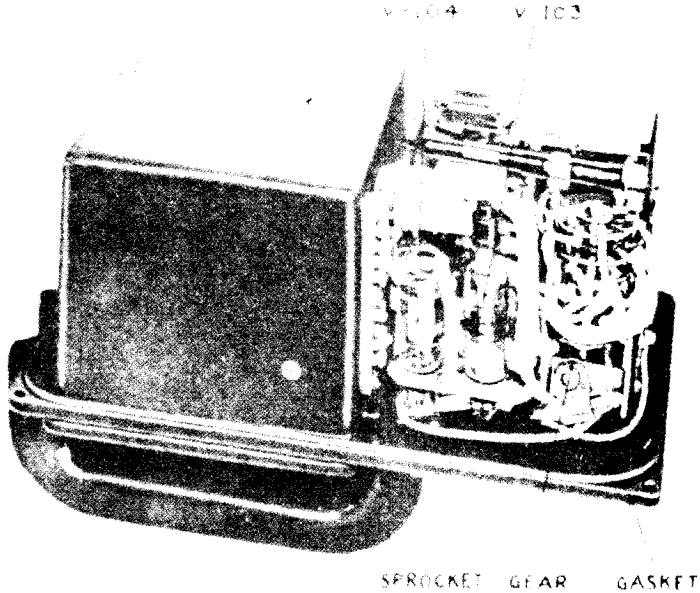

Figure 1-4

Radiometer IM-63/PDR-27A Left Side and Bottom

f. RADIOACTIVE TEST SAMPLE MX-1083/PDR-27. The radioactive test sample consists of a plastic tube containing the equivalent of five microcuries of cobalt 60. The tube is flattened at one end to facilitate handling. Cobalt 60 a radioactive isotope of cobalt, provides a radiation source that permits the operator to ascertain the operating condition of the radiac set when no known radiation field is available.

WARNING

Because cobalt 60 is potentially dangerous, serious skin and internal burns may result if the test sample is held close to the skin for prolonged periods. When using the test sample, handle it only long enough to ascertain the operating condition of the radiac set; then replace it in its storage compartment in the carrying case. If the radioactive test sample is broken, notify the officer-in-charge immediately and request disposal instructions.

g. SPARE PARTS. Spare batteries, G-M tubes, and a corona-discharge voltage regulator tube, are carried in the spare parts compartment of the carrying case.

h. SPARE PARTS BOX. Equipment spares packed in Type M, metal spare parts box, are supplied with each Radiac Set AN/PDR-27A furnished under lots I, II and III of contract NObsr 49282 to the Navy and the Air Force and consist of the spare parts listed in Table 8-2 for the respective service. Equipment spares listed in Table 8-2 for the Signal Corps and Chemical Corps are supplied with each Radiac Set AN/PDR-27A furnished to those services under lots IV and V of contract NObsr 49282 and are packed in fibre board cartons.

3. REFERENCE DATA.

- a . NOMENCLATURE--Radiac Set AN/PDR-27A.
- b . CONTRACT NUMBER AND DATE; NObsr-49282, 1950
- c . CONTRACTOR--Kelley-Koett Instrument Company.
- d . COGNIZANT NAVAL INSPECTOR--Inspector of Naval Materiel, Cincinnati, Ohio
- e . PACKAGES PER SHIPMENT--Two per equipment supplied to Navy and Air Force under lots I, II and III of contract NObsr 49282. One package contains Radiac Set AN/PDR-27A and other contains Equipment Spares boxed. One per equipment supplied to Signal Corps and Chemical Corps under lots IV and V of Contract NObsr 49282.
- f . CUBICAL CONTENTS ---Package #1 containing AN/PDR-27A Radiac Set - Two cubic feet. Package #2 containing Equipment Spares .5 cubic feet.
WEIGHT--Package #1, 23 pounds without batteries, 25-3/4 lbs. with batteries. Package #2 Equipment Spares (boxed), 15 pounds.
- h . RANGES--Four sensitivity ranges: 0.5, 5, 50, and 500 milliroentgens per hour.
- i . TYPE OF DETECTION--Field intensity of gamma radiations alone, or gamma and beta radiations together.
- j . TYPE OF DETECTORS--Geiger-Muller tubes, Navy types BS-1 and BS-2.
- k . POWER SUPPLY--Dry batteries.

<u>Number Req.</u>	<u>JAN type</u>	<u>DC Voltage (Volts)</u>
1	BA-416/U	135
1	BA-413/U	22.5
2	BA-401/U	1.5

TABLE 1-3. SHIPPING DATA

Shipping Box No.	CONTENTS		OVERALL DIMENSIONS			Volume	*Weight
	Name	Designation	Height	Width	Depth		
1	Radiac Set	AN/PDR-27A	11-1/2	17	12-1/2	1.41	23
2	Equipment	Spare parts	13	7	7	.5	15

Dimensions are in inches, volume cubic feet, weight pounds.

* Without Batteries

SECTION 2

THEORY OF OPERATION

1. RADIOACTIVITY AND ITS DETECTION.

a. INTRODUCTION--With the arrival of atomic energy as an important factor in national defense, armed forces personnel are called upon to take part in the handling, measurement, and detection of radioactive materials. The following paragraphs will acquaint such personnel with the nature of atomic radiations, the necessity for detecting them, and methods of detection.

b. ATOMIC RADIATION--Many chemical elements, such as radium and uranium, and materials exposed to powerful radio-active disintegrations have the property of expelling radiations or rays which are invisible to the eye. Some of these radiations can penetrate the human body and, if they are of sufficient intensity or duration, can cause serious injury and death. To prevent exposure to damaging concentrations of radioactive materials and to prevent exposure to damaging radiation fields, equipment is provided which detects the presence of these radiations and measures their intensity.

Emissions by radioactive substances are generally composed of alpha, beta, and gamma radiations. Certain characteristics of these radiations are important aids in their detection and measurement. The alpha has a positive charge; it ionizes gases strongly, but it has weak penetrating power. The beta has a negative charge; it does not ionize gases as readily as the alpha, but its penetrating power is much greater. The gamma has no charge; it ionizes gas molecules by reaction with them, and its penetrating power is stronger than that of the alpha and beta radiations.

c. DETECTION OF RADIATION--The ability of alpha, beta, and gamma radiations to ionize gases is the characteristic most frequently used to detect the presence of radiation. A simple device for such detection is the G-M tube (figure 2-1). The tube is filled with a gas mixture at

low pressure. A thin wire, the anode of the tube, is oriented axially to a cylinder and insulated from it. A voltage is impressed across the tube so that the wire is positive with respect to the cylinder. The magnitude of the impressed voltage is just below that necessary to ionize the gas molecules and cause conduction. Therefore, in the dormant condition, no current flows. When radiation is present in the vicinity of the tube, an incoming radiation usually ionizes some molecules of the gas within the tube. The ionized gas particles are attracted toward either the cylinder or the wire, depending on their charge. On their way through the gas, these ionized gas particles collide with non-ionized gas molecules and ionize them. As a result of this action, a large portion of the gas becomes ionized, this producing a large current flow. This current flow is quenched quickly, either by a small amount of organic vapor which is included in the gas mixture or by the use of external circuits which reduce the potential between the tube elements after conduction. As soon as tube conduction stops, the voltage across the tube is returned to the original preignition value, and the tube awaits the next ionizing event. The duration of tube conduction is short compared to the average time between ionizing events and, therefore, the tube output is in the form of a series of pulses. Because of the fluctuating intensity of the ionizing radiations, the random time interval between ionizing events, and the chance arrangement of the gas molecules in the G-M tube, the pulses produced by the tube vary in amplitude (1/2-volt to 50 volts) and duration (50 to 100 microseconds), and occur at random time intervals. These pulses are generally used to activate various indicating devices.

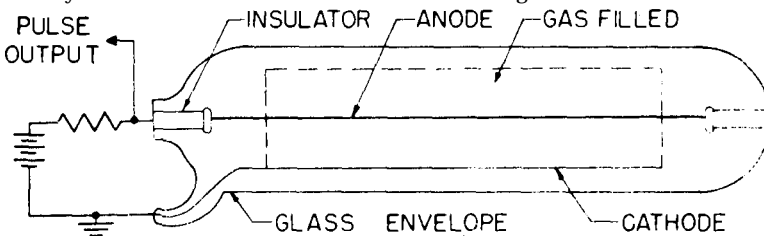

Figure 2-1. Typical Geiger - Muller Tube

d. MEASUREMENT OF RADIATION--The unit of measurement of radiation is called the "roentgen", or "r", and is defined as the amount of gamma radiation that will produce one electrostatic unit of charge in one cubic centimeter of air that is surrounded by an infinite mass of air at standard conditions.

Radiation values are usually expressed as milliroentgens per hour, (one thousandths of an "r") or mr/hr. Human tolerance to radiation is usually defined in terms of these units. Radiation intensity (in mr/hr) decreases rapidly as the distance from the radioactive object is increased.

2. GENERAL CIRCUIT DESCRIPTION. (See figure 2-2.)

--Dry batteries supply + 135-volt d-c power to the high-voltage power supply and the shunt voltage regulator circuits, 1.5-volt d-c filament power to the high-voltage power supply, the shunt voltage regulator, and the pulse shaper and amplifier circuits, and a 22.5-volt d-c bias voltage to the shunt voltage regulator circuit. The batteries are the source of all power for the equipment and, at 250 C. (77° F.), can power it for approximately 40 hours of continuous operation.

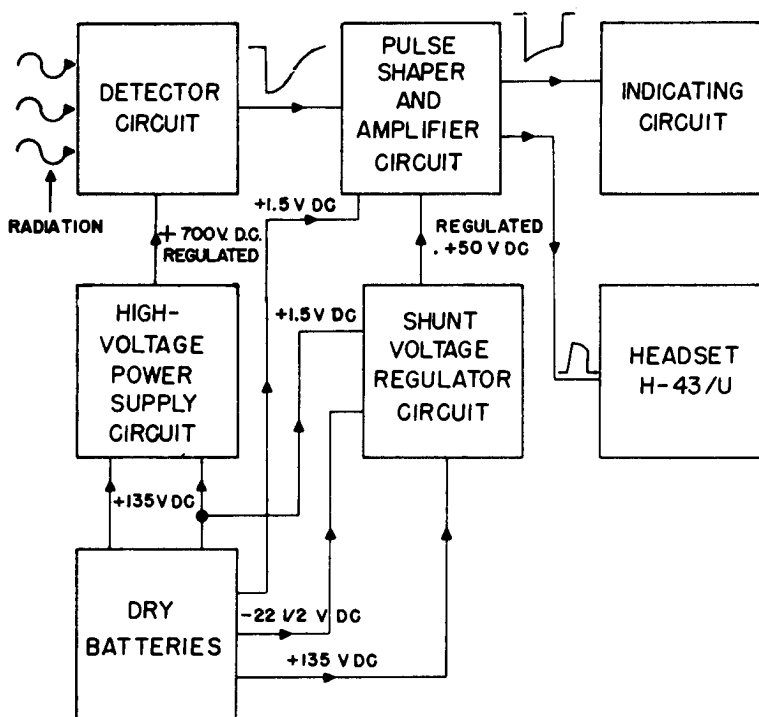

Figure 2-2. Radiac Set AN/PDR-27A, Block Diagram

The high-voltage power supply circuit converts the +135-volt d-c power from the batteries into regulated

+700-volt d-c power that is fed to the G-M tubes in the detector circuit. The power supply circuit operates on the "fly-back" principle, and utilizes a corona-discharge regulator tube to maintain the relatively constant output voltage.

The G-M tubes generate voltage pulses when exposed to radioactivity. The average repetition rate of these pulses is proportional to the average radiation field intensity in the vicinity of the tubes, and this rate is used in the radiac set to measure the radiation intensity. The pulses generated in the G-M tubes are of random amplitude and random duration and are fed to the pulse shaper and amplifier circuit. This circuit is a one-shot multi-vibrator which converts the G-M pulses into pulses of constant area and feeds them to the integrating and indicating circuit. The duration of these pulses is different for each sensitivity range.

The integrating and indicating circuit converts the pulses fed from the pulse shaper and amplifier circuit to a meter reading proportional to the pulse reception rate. The factor of proportionality depends on the sensitivity range selected by means of the range switch. The meter scales are changed automatically when the sensitivity range of the radiac set is changed by operation of the range switch. Consequently, the meter is always direct reading.

The shunt voltage regulator circuit maintains the plate voltage of the pulse shaper and amplifier circuit at a relatively constant value as the battery voltage decreases with age.

3. CIRCUIT ANALYSIS.

a. DETECTOR CIRCUIT. (See Fig. 2-3)--The detector circuit consists of G-M tubes V-101 and V-102, anode load resistor R-101, coupling capacitors C-109, C-110, and section S-101A of range switch S-101.

The two G-M tubes are used as radiation detectors. Tube V-102, a Navy type BS-1 tube, is the more sensitive of the two and is used in the probe. When S-101A is in either the .5 or 5 position, V-102 is connected to the radiacmeter and V-101 is disconnected. When S-101A is in either the 50 or 500 position, V-101, a Navy type BS-2 tube, is connected to the radiacmeter, and V-102 is disconnected.

When S-101A is turned to one of the range positions, regulated + 700-volt d-c power is applied to the anode of the selected G-M tube through R-101. When the G-M tube conducts under the influence of an ionizing event, a voltage pulse is developed across anode load resistor R-101. This pulse is capacitively coupled through C-109 and C-110 to the input grid of V-105 in the pulse shaper and amplifier circuit. The output of the G-M tube is a series of negative-going pulses, one for each ionizing event that occurs within the tube. The approximate average duration of these pulses is 80 microseconds, and their average amplitude is approximately 5 volts, although pulse amplitudes of 50 volts occur occasionally.

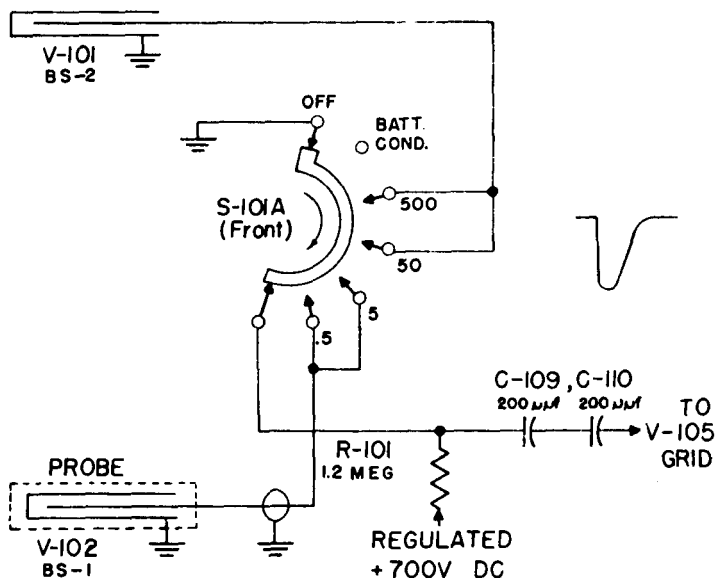

Figure 2-3. Detector Circuit

b. PULSE SHAPER AND AMPLIFIER CIRCUIT. (See Fig. 2-4)--The pulse shaper and amplifier circuit consists of tubes V-105 and V-106, section S-101C of range switch S-101, and associated resistors and capacitors. This circuit converts the random-amplitude, random-duration pulses from the detector circuit into pulses of constant

amplitude and constant duration and feeds them to the integrating and indicating circuit. The amplitude and duration of the output pulses are seriously affected by changes in the plate supply voltage of V-105 and V-106. To eliminate this effect, the plate supply voltage for both tubes is regulated.

Tubes V-105 and V-106 comprise a single-shot multivibrator. In the dormant state, that is, when no pulses are received from the detector circuit, V-105 is conducting and V-106 is cut off. Resistor R-119 is the plate load for V-105, which is made to operate as a triode by connection of its screen grid to its plate. Resistors R-117 and R-118 comprise a voltage divider; these resistors, in conjunction with common cathode resistor R-120, establish the steady-state grid bias for V-105. As a result of this bias, V-105 conducts in the dormant state. Tube V-106 is also used as a triode amplifier, because its screen grid is connected to its plate. The control grid of V-106 is connected, via one of the resistance paths, through S-101C to ground. The cathode of V-106 is connected to the cathode of V-105 and is, therefore, held positive by the steady-state current through V-105; thus, V-106 is held in the cut-off condition during the dormant state.

The negative-going pulses from the detector circuit are applied to the control grid of V-105. These pulses drive the grid of V-105 more negative. The resulting rise in the plate potential of V-105 is coupled through capacitor C-111 to the control grid of V-106, causing V-106 to conduct heavily, and charging C-111. Plate voltage for V-106 is applied through components of the integrating and indicating circuit. As long as V-106 conducts, V-105 is held at cut-off by the rise in cathode potential caused by the plate current flow of V-106 through common cathode resistor R-120. Capacitor C-111 now discharges through the selected resistance path and S-101C to ground. Tube V-106 conducts until the discharge of C-111 has lowered its control grid voltage to cut-off. The length of time that V-106 conducts is determined by the R-C time constant of C-111 and the selected resistance path to ground. Four separate resistance paths to ground from the V-106 grid are provided by R-103 and R-104, R-105 and R-106, R-107 and R-108, and R-109 and R-110. Potentiometers R-104, R-106, R-108, and R-110 are provided for calibration of the equipment.

When V-106 reverts to cut-off, the corresponding drop in its cathode potential, directly coupled to the cathode of V-105, permits V-105 to conduct its steady-state current again. Since the average time between successive pulses from the detector circuit is considerably longer than the duration of the conduction of V-106, the entire circuit reverts to its steady-state condition after each input pulse.

The output of V-106, a series of current pulses, is fed to the integrating and indicating circuit. The duration of the V-106 output pulses is determined primarily by the time constant of the selected coupling circuit, and is thus constant for any particular range; each range has a different time constant because the grid-to-ground resistance of V-106 is changed by S-101C whenever ranges are changed. Consequently, the duration of the output pulse changes when ranges are changed.

The pulsed fluctuations of the V-105 and V-106 cathodes are applied to a voltage divider circuit consisting of R-122, C-112, and R-123. The a-c component of the cathode fluctuations generates a voltage across R-123, and this voltage is applied to jack J-101. A headset may be connected to J-101 for aural monitoring of the radiation intensity.

c. INTEGRATING AND INDICATING CIRCUIT. (See Fig. 2-5)--The integrating and indicating circuit consists of capacitor C-103, resistor R-121, and meter M-101. Capacitor C-103 is connected in parallel with the series combination of M-101 and R-121. The complete circuit is connected between the plate of V-106, in the pulse shaper and amplifier circuit, and the plate supply. When V-106 conducts, C-103 is charged through the relatively low impedance of V-106. During the inter-pulse interval, V-106 is cut off, causing C-103 to discharge through M-101 and R-121.

Capacitor C-103, resistor R-121, and meter M-101 form a standard integrating circuit. The function of this circuit is to convert the output pulses of V-106 into a meter current proportional to the radiation intensity. The average current through M-101 is proportional to the average voltage across C-103. This voltage, in turn, depends on the following factors:

1. The number of pulses per second received from V-106.
2. The amplitude and duration of each pulse.

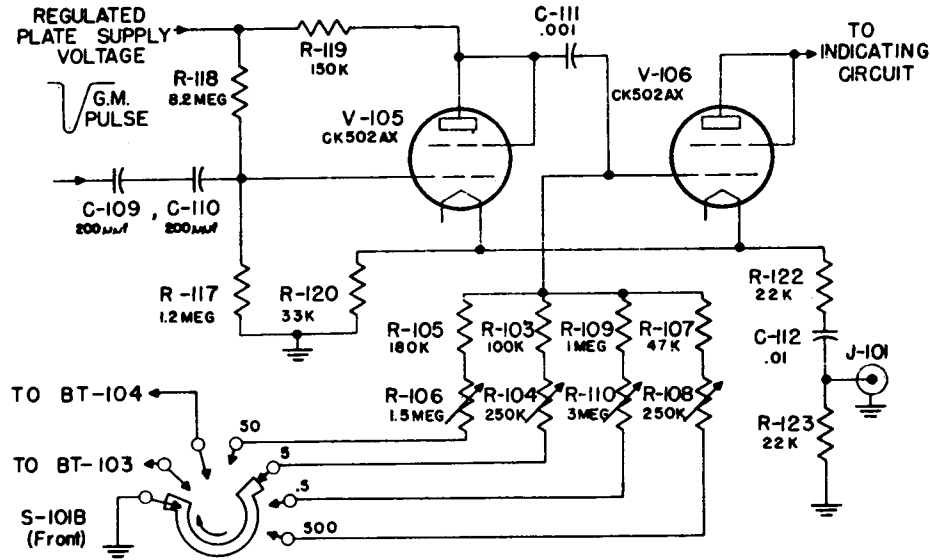

NOTE:
 SWITCH S-101B (Front) SHOWN
 IN "OFF" POSITION.

Fig. 2-4 Pulse Shaper and Amplifier Circuit

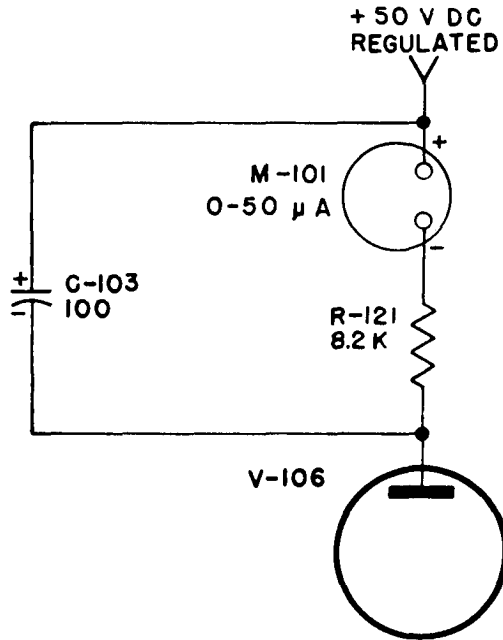

Figure 2-5. Indicating Circuit

Since the number of pulses per second is proportional to the radiation intensity, the average meter current will be proportional to the radiation intensity as long as the amplitude and duration of each pulse remain the same--i.e., at any one position of range switch S-101. When ranges are changed, the amplitude and duration of the pulses from V-106 change; consequently, the meter current per pulse per second also changes.

The meter deflection is proportional to the number of pulses per second and the number of pulses per second is, in turn, proportional to the radiation intensity for a given source of radiation. Consequently, the meter scale can be calibrated to indicate mr/hr directly.

d. RANGE SWITCH CIRCUITS. (See Fig. 2-6)--The functions performed by each of the five range switch S-101 sections are as follows:

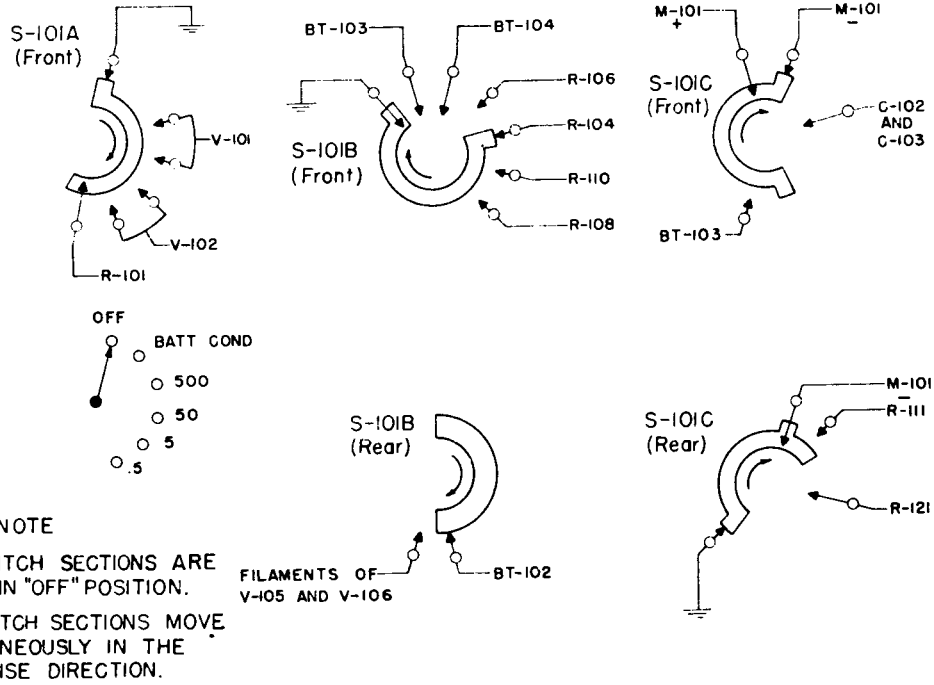

Fig. 2-6 Range Switch Circuits

Position

Function

SWITCH SECTION S-101A

OFF	Grounds output side of high-voltage power supply filter.
BATT COND	None
500	Connects high-voltage power supply output to V-101.
50	Same as position 500
5	Connects high-voltage power supply output to V-102.
.5	Same as position 5.

SWITCH SECTION S-101B
(Side away from Knob)

OFF	Disconnects BT-102 from V-105 and V-106 filaments.
BATT COND	Connects BT-102 to V-105 and V-106 filaments.
500	Same as position BATT COND.
50	Same as position BATT COND.
5	Same as position BATT COND.
.5	Same as position BATT COND.

SECTION S-101B (Knob Side)

OFF	Grounds V-106 control grid circuit.
BATT COND	Grounds negative side BT-103. Grounds V-106 control grid circuit.

<u>Position</u>	<u>Function</u>
500	Grounds negative side of BT-103 and BT-104. Grounds V-106 control grid through R-107 and R-108.
50	Grounds negative sides of BT-103 and BT-104. Grounds V-106 control grid through R-105 and R-106.
5	Grounds negative sides of BT-103 and BT-104. Grounds V-106 control grid through R-103 and R-104.
.5	Grounds negative sides of BT-103 and BT-104. Grounds V-106 control grid through R-109 and R-110.

SECTION S-101C (Knob Side)

OFF	Applies direct short circuit to M-101 terminals.
BATT COND	Connects positive side of BT-103 to positive side of M-101.
500	Connects positive side of M-101 to plate voltage supply of the pulse shaper and amplifier circuit.
50	Same as position 500.
5	Same as position 500.
.5	Same as position 500.

SECTION S-101C (Side away from Knob)

OFF	Grounds negative side of M-101.
-----	---------------------------------

<u>Position</u>	<u>Function</u>
BATT COND	Connects negative side of BT-103, through R-111, to negative side of M-101.
500	Connects negative side of M-101 to plate voltage supply end of R-121.
50	Same as position 500.
5	Same as position 500.
.5	Same as position 500.

e. FILAMENT POWER SUPPLY CIRCUIT. (See Fig. 7-8) -- Battery BT-102 provides 1.5-volt d-c power for the filaments of V-105 and V-106, and is connected to these filaments in all positions of range switch S-101, except "OFF". This battery floats across the filaments, thus permitting a potential difference to exist between the filaments and ground.

Battery BT-103 provides 1.5-volt d-c power for the filaments of V-104, and V-107; the battery is connected to the filaments in all positions of S-101 except OFF.

In the BATT COND position of S-101, M-101 and R-111 are connected in series across BT-103 to provide an indication of battery condition. A line, marked BATT, on the meter face indicates the minimum operating voltage of the battery.

f. HIGH-VOLTAGE POWER SUPPLY CIRCUIT. (See Fig. 2-7)--The high voltage power supply circuit consists of a relaxation oscillator circuit, a power amplifier circuit, a rectifying and filtering circuit, and a regulating circuit.

(1) RELAXATION OSCILLATOR CIRCUIT. In this circuit, + 135-volt d-c power from the BT-104 is applied through resistor R-112 to capacitor C-104. Tube E-104, a cold-cathode glow discharge tube, is connected across C-104. Capacitor C-104 charges slowly until it reaches a value equal to the striking voltage, approximately 90 volts, of E-104. As soon as 90 volts is reached, E-104 conducts

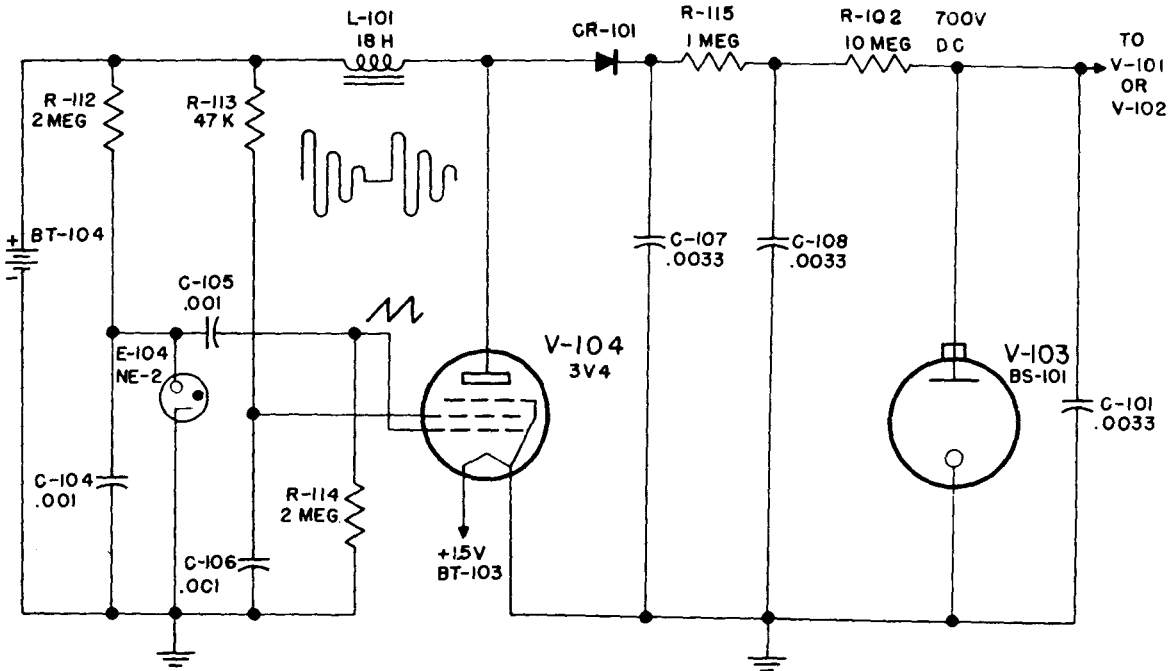

Fig. 2-7 High Power Supply Circuit

heavily and discharges C-104 almost instantaneously. Capacitor C-104 then starts to charge again, and the cycle is repeated as long as the equipment is operating. The sawtooth voltage across C-104 is coupled through capacitor C-105 to the control grid of V-104 in the power amplifier circuit.

(2) POWER AMPLIFIER CIRCUIT. (See Fig. 2-7)--In the power amplifier circuit, +135-volt d-c power is fed through plate load inductor L-101 to power amplifier tube V-104. Resistor R-113 and capacitor C-106 provide the screen grid bias of V-104. The positive-going part of the sawtooth voltage applied to the grid of V-104 causes the V-104 plate current to build up gradually, then the negative going portion of the sawtooth voltage drives the grid rapidly beyond cut-off. When the plate current of V-104 is cut off by the sharp fall of grid voltage, the collapse of the magnetic field of L-101 causes a damped oscillating voltage to exist on the V-104 plate. The amplitude of the oscillations is large because of the large inductance of L-101 and the sudden current change. This oscillating voltage is applied to the rectifying and filtering circuit.

(3) RECTIFYING AND FILTERING CIRCUIT. (See Fig. 2-7)--In the rectifying and filtering circuit, the oscillations of L-101 are rectified. Half-wave rectification is provided by selenium rectifier CR-101; the rectified voltage is filtered in a network consisting of resistor R-115 and capacitors C-107 and C-108. The rectified oscillations provide approximately 900-volt d-c power at the junction of R-115 and C-108. This output is applied to the regulating circuit.

(4) REGULATING CIRCUIT. (See Fig. 2-7)--The regulating circuit consists of resistor R-102 in series with corona-discharge tube V-103. Tube V-103 functions in a manner similar to the standard gaseous discharge voltage regulator tubes, except that it regulates at 700 volts. Resistor R-102 limits the current through V-103. Capacitor C-101, in parallel with V-103, by-passes noise and stray voltages induced in the wires. Regulated 700-volt d-c power is fed from the junction of R-102 and V-103 to resistor R-101 in the detector circuit.

g. REGULATED PLATE VOLTAGE POWER SUPPLY CIRCUIT. (See Fig. 2-8)--The regulated plate voltage power supply circuit consists of battery BT-104, a shunt voltage regulator circuit, and storage capacitor C-102. Battery power is applied through resistor R-127 to a voltage divider consisting of resistors R-124 and R-125. The control grid of shunt voltage regulator V-107 is held at a potential of 22 1/2 volts below the potential existing at the junction of R-124 and R-125 by means of battery BT-101. The screen grid of V-107 is connected to the plate. The voltage existing on the V-107 plate depends on the potential drop caused by the V-107 plate current through R-127 and R-126. The V-107 plate current is, in turn, governed by the potential on the control grid.

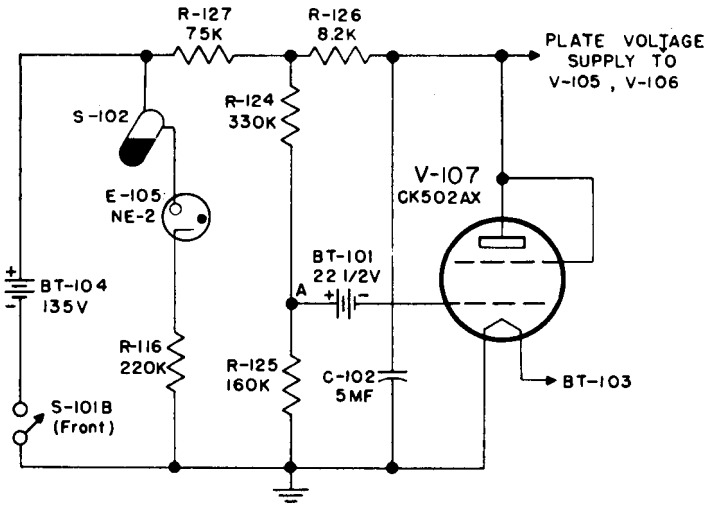

Figure 2-8. Regulated Power Supply Circuit

As the batteries age their output voltage decreases, causing a corresponding decrease in the potential applied to the V-107 grid. The resulting decrease in V-107 plate current causes a corresponding decrease in the potential drop across R-127 and R-126. Thus as the battery voltage decreases, the potential drop across R-127 and R-126 decreases; this action tends to maintain the voltage at the plate of V-107 at a constant value throughout the usable life of the batteries.

The load of this power supply consists of a series of short-duration, high-current pulses, separated by relatively long periods of zero current. The shunt voltage regulator and batteries alone are not capable of supplying the pulse current requirements without serious decreases in voltage. However, the supply voltage must remain constant during the pulse. Therefore, storage capacitor C-102, connected across V-107, is used to maintain the voltage at a constant level. During each current pulse, C-102 acts as a low-impedance source of power; during the interpulse interval, the charge on C-102 is replenished. Capacitor C-102 is sufficiently large to prevent a substantial decrease in voltage during the load-current pulse.

h. METER ILLUMINATION CIRCUIT. (See Fig. 2-8)--
The meter illumination circuit consists of mercury switch S-102, glow-discharge lamp E-105, and resistor R-116, all connected in series across S-101B and BT-104. Switch S-102 is open when the radiacmeter panel is horizontal; however, when the radiacmeter is held so that the panel is almost vertical, S-102 closes automatically, causing E-105 to illuminate the face of meter M-101, if S-101B is turned to one of the four operating ranges. Resistor R-116 limits the current through E-105 to its operating value.

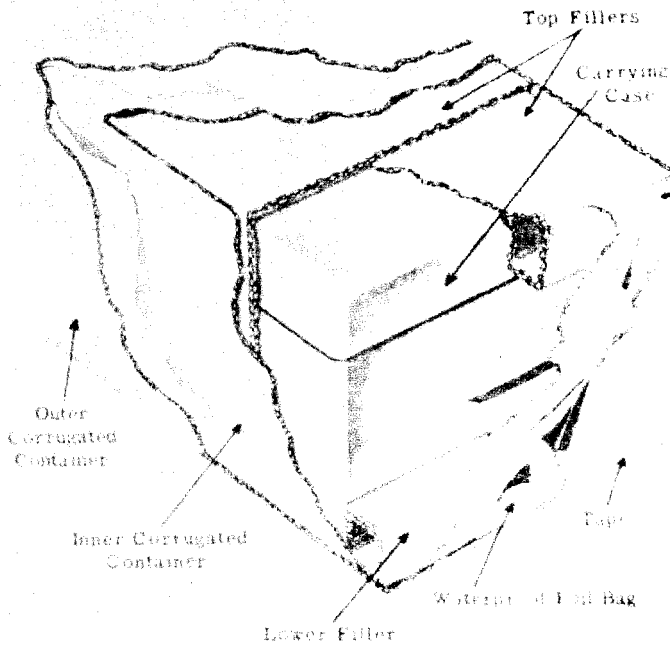

Fig. 3-1 Cutaway View of Packing Carton

SECTION 3 INSTALLATION

1. UNPACKING. (See Fig. 3-1)--The radiac set is shipped in a packing case composed of two cardboard boxes, one within the other, with a moisture proof foil bag between them.

The packing case is approximately 18 inches long, 13 inches wide and 12 inches high.

Step 1. Open outer box and remove inner box with foil bag.

Step 2. Remove foil bag.

Step 3. Open inner box and remove carrying case.

Step 4. Open carrying case and discard wadding.

2. INSTALLATION Batteries must be installed in the radiac set before the set can be operated. In addition, one set of spare batteries should be placed in the carrying case; these batteries are to be used as field spares. When installing batteries, perform the following steps:

Step 1. Obtain batteries listed in Table 1-2 from Supply Department.

Step 2. Place spare batteries in the spare battery compartment of the carrying case.

Step 3. Remove the radiacmeter from the carrying case. Remove the four screws securing the handle and cover of the battery compartment. Remove the cover.

Step 4. Place the batteries in the battery compartment as shown on diagram inside battery compartment or in Fig. 3-2.

Step 5. Replace the cover.

Step 6. Replace the screws securing the cover and tighten.

CAUTION

Do not use excessive force in tightening screws. Breakage may result.

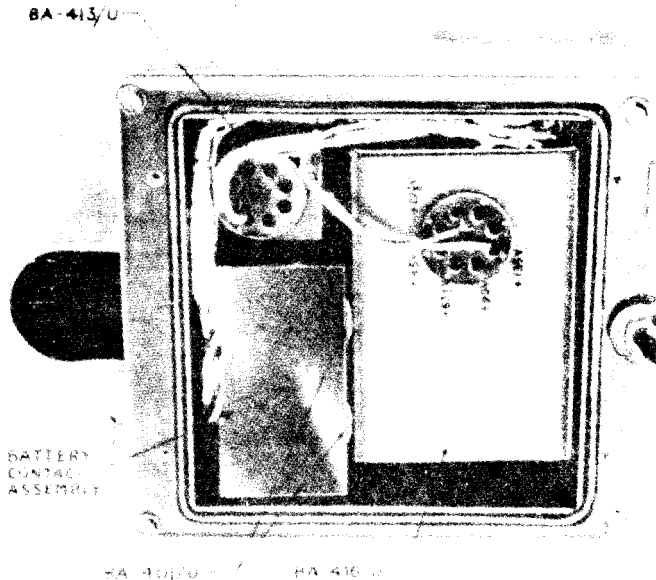

Figure 3-2

Radiacmeter IM-63/PDR-27A Battery Compartment

3. INITIAL TESTING. (See Fig. 3-3)--Test the radiac set before placing the unit in operation by performing the following steps:

- Step 1. Remove the radiacmeter from the carrying case.
- Step 2. Turn the range switch to BATT COND. The indicating meter pointer should now rest on the right of the line marked BATT. (1/2 scale or over).
- Step 3. Turn the range switch to 500. The meter reading should be zero.

CAUTION should be exercised in the following steps.

Steps 4 through 9 involve handling of the radioactive test sample containing cobalt 60. Exercise the utmost precaution in handling the test sample. Obey all safety regulations. Perform steps 4 through 9 as rapidly as possible to avoid prolonged exposure to the radiation.

- Step 4. Remove the radioactive test sample from the carrying case.
- step 5. Turn the range switch to 500. Hold the test sample under the radiacmeter housing as shown in figure 3-3A. Move the test sample to and fro to obtain maximum meter deflection. The meter reading should be 15 to 30 mr/hr.
- Step 6. Turn the range switch to 50. Hold the test sample under the radiacmeter housing as shown in figure 3-3A. Move the test sample to and fro to obtain maximum meter deflection. The meter reading should be 12 to 22 mr/hr.
- Step 7. Turn the range switch to 5. Hold the active end of the test sample near the radiacmeter probe as shown in figure 3-3B. The meter readings should be 1.5 to 2.5 mr/hr.
- Step 8. Turn the range switch to .5. Hold the test sample near the radiacmeter probe, as shown in figure 3-3B, with the active end of the sample pointing away from the probe. The meter reading should be 0.18 to 0.30 mr/hr.
- Step 9. Replace the test sample in the carrying case.
- Step 10. If the meter readings specified in steps 2, 3, 5, 6, 7, and 8 are obtained, the radiac set is in proper operating condition. If any of the meter readings are incorrect, trouble shoot the radiac set as instructed in Section 7.

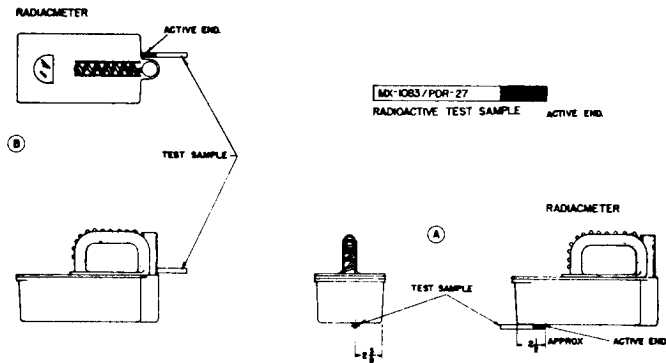

Fig. 3-3 Radiacmeter Test Set-up



Fig. 3-4 Survey Meter AN/PDR-27A showing attachment with shoulder harness.

SECTION 4 OPERATION

1. GENERAL This section contains the procedures for starting the radiac set, for operating it to detect and measure atomic radiation and to locate radio-active objects or areas, and for stopping the equipment.

The radiac set indicates the presence of radiation by clicks in the headset and by the reading shown on the radiacmeter panel meter. The meter reading and the frequency of the clicks are proportional to the radiation intensity.

2. STARTING THE EQUIPMENT.

Step 1. Remove the radiacmeter, shoulder harness, and headset from the carrying case. (See figure 1-1)

Step 2. Slip the harness over one shoulder, and hook the radiacmeter to the harness.

Step 3. When aural indications are desired, put on the headset, and connect its plug to the jack on the radiacmeter panel.

Step 4. Turn the range switch to BATT COND.

Step 5. Observe the meter indication. If the pointer rests at the left of the line marked BATT on the meter face, replace the batteries in the radiacmeter as instructed in Section 3, par. 2.

Step 6. Turn the range switch to 500.

3. RADIATION DETECTION AND MEASUREMENT.

Step 1. Listen for clicks in the headset or observe the meter reading while approaching the radioactive object or area.

Note

If the radiac set is used in a dimly lighted area, tilt the radiacmeter so that the panel is in a 45-degree position whenever the meter reading is to be observed. Tilting the radiacmeter turns on an internal lamp and illuminates the meter face.

- Step 2. If clicks are detected but the meter reads 5 divisions or less, it should be switched to a lower or more sensitive range, conversely when the meter approaches a full scale reading it should be switched to a higher (less sensitive) range.
- Step 3. When using only the headset for detection, keep the range switch at 500. When the radiation intensity is relatively weak, turn the switch to 5.
- Step 4. When it is desired to locate a radioactive object or the center of a radioactive area, move the radiacmeter in the direction that produces an increase in the meter reading or in the frequency of the clicks in the headset. Continue moving in this direction until the point of maximum radiation intensity is found.
- Step 5. To facilitate detection and measurement when the object or area to be investigated is relatively inaccessible, lift the radiac detector out of the well on the radiacmeter. Set the range switch at .5 or whenever the radiac detector is used in this manner.
- Step 6. When the radiation from an object or area is extremely weak, bring the radiation detector within a few inches of the object in order to obtain an indication on the radiacmeter, because the radiation intensity decreases rapidly with distance.
- Step 7. To check the combined beta and gamma radiation of an object, turn the range switch to .5 or 5, lift the radiac detector out of the well on the radiacmeter, and move aside the beta shield at the end of the radiac detector probe. Point the exposed end of probe at the object to be investigated and move it slowly until a readable meter indication is obtained.
- Step 8. If the equipment has been used continuously for more than 20 hours, check the condition of the batteries in the radiacmeter by turning the range switch to BATT COND. When the meter pointer rests to the left of the line marked BATT on the meter face, replace the batteries as instructed in section 3, par. 2.

4. STOPPING THE EQUIPMENT.

- Step 1. Turn the range switch to OFF.
- Step 2. Disconnect the headset plug from the jack on the radiacmeter panel, and remove the headset. (If used)
- Step 3. Place the radiac detector in the well on the radiacmeter.
- Step 4. Unhook the radiacmeter from the shoulder harness.
- Step 5. Place the radiacmeter, harness, and headset in the carrying case.

5. SUMMARY OF OPERATION.

- a. Remove the equipment from the case, attach the shoulder harness, and plug in the headset.
- b. Check the battery condition by turning the range switch to BATT COND. The meter pointer should rest at the right of the line marked BATT on the meter face.
- c. Set the range switch at either 500, 50, 5, or .5, depending on the intensity of the radiation.
- d. Check for the presence and the intensity of radiation by observing the meter reading or the frequency of the clicks in the headset.
- e. When necessary, illuminate the meter face by tilting the radiacmeter so that the panel is in a 45-degree position.
- f. When the combined beta and gamma radiation from an object is to be measured, turn the range switch to .5 or 5, remove the radiac detector from the well of the radiacmeter, move aside the beta shield on the probe, point the probe at the object to be investigated, and move the probe close enough to the object to obtain a meter indication.
- g. Stop the equipment by turning the range selector switch to OFF. Remove the harness and headset from the radiacmeter, replace the radiac detector in the well of the radiacmeter, and replace all items in the carrying case.

CAUTION

The batteries should be removed from the radiac set and from the case if the set is not to be used for a prolonged period. (Approximately 3 months)

SECTION 5 OPERATOR'S MAINTENANCE

FAILURE REPORTS

A FAILURE REPORT must be filled out for the failure of any part of the equipment whether caused by defective or worn parts, improper operation, or external influences. It should be made on Failure Report form NBS-383, which has been designed to simplify this requirement. The card must be filled out and forwarded to BUSHIPS in the franked envelope which is provided. Full instructions are to be found on each card. (See figure 5-1 for sample form.)

Use great care in filling the card out to make certain it carries adequate information. For example, under "Circuit Symbol" use the proper circuit identification taken from the schematic drawings, such as CR-101, in the case of the rectifier, or R-112, for a resistor. Do not substitute brevity for clarity. Use the back of the card to completely describe the cause of failure and attach an extra piece of paper if necessary.

The purpose of this report is to inform BUSHIPS of the cause and rate of failures. The information is used by the Bureau in the design of future equipment and in the maintenance of adequate supplies to keep the present equipment going. The cards you send in, with those from hundreds of other ships and stations furnish a store of information permitting the Bureau to keep in touch with the performance of the equipment of your ship or station and all other activities of the Navy.

This report is not a requisition. You must request the replacement of parts through your Officer-In-Charge in the usual manner.

Make certain you have a supply of Failure Report cards and envelopes on board. They may be obtained from any Electronics Officer.

OPERATOR'S MAINTENANCE

1. ROUTINE CHECKS

a. BATTERY CHECK--To check the condition of the radiacmeter batteries, perform the following steps:

5-0

ORIGINAL

Step 1. Turn the range switch to BATT COND.

Step 2. When the meter pointer rests to the left of the line marked BATT on the meter face, replace the batteries as instructed in Section 3, par. 2.

2. EMERGENCY MAINTENANCE

Notice to operators

Do not perform the following emergency maintenance procedure without proper authorization. Replacement of tubes or batteries in the radiacmeter or radiac detector is the only emergency maintenance possible during operation of the radiac set. Replace tubes as instructed in Section 7.

The battery test described in paragraph 1 above indicates the condition of BT-103 only. Therefore, it is advisable to replace the other batteries as an additional precaution before attempting further trouble shooting unless the other batteries were recently replaced.

The image shows two overlapping forms used for reporting equipment failures. The top form is titled "FAILURE REPORT—ELECTRONIC EQUIPMENT" and includes fields for "EQUIPMENT NAME", "SERIAL NUMBER", "DATE", and "TYPE OF FAILURE". The bottom form is titled "ELECTRONIC EQUIPMENT FAILURE REPORT (EAF)" and is more detailed, with sections for "EQUIPMENT DETAILS", "SYMPTOMS", "TYPE OF FAILURE", and "REPAIR ACTIONS". It includes checkboxes for various failure modes and fields for recording specific data like "TYPE OF FAILURE" and "REPAIR ACTIONS".

Figure 5-1. Failure Report

SECTION 6

PREVENTIVE MAINTENANCE

1. GENERAL

Preventive maintenance is maintenance performed on equipment (usually when the equipment is not in use) to keep it in good working order so that there will be minimum interruptions in service. Preventive maintenance differs from trouble shooting and repair in that its object is to prevent the occurrence of troubles.

2. ROUTINE MAINTENANCE CHECK CHART

The procedures listed in table 6-1 are to be performed at the intervals indicated, unless these intervals are modified by the officer-in-charge.

NOTE

The attention of maintenance personnel is invited to the requirements of Chapter 67 of The Bureau of Ships Manual of the latest issue.

3. RE-TROPICALIZATION

The radiac set has been moistureproofed and fungi-proofed at assembly. No further treatment is required unless parts are replaced. Refer to Specification JAN-T-152, Treatment, Moisture and Fungus-resistant, of Communications, Electronic, and Associated Electrical Equipment for the procedures to be used in re-tropicalization following parts replacement.

Masking is not required if the fungus and moisture proofing varnish is applied by brush. Care should be taken that the varnish is not applied to the contacts on the rotary switch or the clips holding the BS-2 tube. The varnish should not be allowed to flow into the tube sockets.

TABLE 6-1. ROUTINE MAINTENANCE CHECK CHART

What to Check	When to Check	How to Check	Precautions
1. Battery condition	Weekly	Turn range switch to BATT COND. Meter pointer should rest at right of line marked BATT.	Return range switch to OFF.
2. Exterior surfaces of radiacmeter, radiac detector, and shoulder harness.	Weekly	Wipe with a clean, dry cloth, removing all dirt and dust.	None
3. Radiacmeter front panel screws.	Weekly	Tighten with screw driver.	Do not tighten excessively.
4. Range switch knob.	Weekly	Rotate the knob. If loose, tighten setscrew with screw driver. Check to see that the knob rests snugly against the gasket. If it does not, loosen setscrew, push knob tightly against gasket, and re-tighten setscrew.	Do not tighten setscrew excessively.

TABLE 6-1. ROUTINE MAINTENANCE CHECK CHART (cont.)

What to Check	When to Check	How to Check	Precautions
5. Radiac detector plug.	Weekly	Remove all dirt from the plug. Obtain the special wrench H-301 from the carrying case. Insert the rounded end of the wrench into the plug slot and tighten.	Do not tighten excessively.
6. Packing glands at both ends of the radiac detector cable.	Weekly	Tighten with 3/8" open end wrench.	Do not tighten excessively.
7. Radiacmeter circuit.	Monthly	Check the radiacmeter with the radioactive test sample. (See Section 3, par. 3.)	In order to keep a continuous check on the sensitivity and calibration accuracy of the radiac set in desired, record the meter readings obtained in this test. Due to the disintegration of the material in the test sample, the reading observed each month will be approximately 1% less than that observed the previous month. If reading decreases radically investigate and correct the trouble.
8. Headset	Monthly	Remove dirt. Check tightness of screws and connections.	None

SECTION 7

CORRECTIVE MAINTENANCE

1. GENERAL

This section describes the symptoms produced by malfunctioning of the radiac set and the procedures used for localizing and correcting troubles.

The most common cause of failure will be dead batteries. Always check the battery condition by turning the meter switch to "BATT COND" when the radiacmeter is inoperative. When the indicating meter pointer rests to the left of the line marked "BATT", the batteries are depleted and should be replaced. This test, however, checks the condition of BT-103 only. Since it is possible that the other batteries are defective, it is advisable to replace the other batteries before attempting to trouble shoot the equipment unless the other batteries were recently replaced.

Note that the operation of the radiacmeter, radiac detector, and headset can be checked with the radioactive test sample. (See Section 3, par. 3.) This test will yield an accurate qualitative estimate of the performance of the equipment; however, the absolute accuracy of the calibration cannot be determined by this means. The test should be made whenever the existence of trouble is suspected. If an incorrect indication is obtained, note the symptoms of the trouble, then localize the fault as instructed in the following paragraphs.

2. THEORY OF LOCALIZATION

The radiac set consists essentially of the G-M tubes, the high-voltage supply circuit, the pulse shaper and amplifier circuit, the integrating and indicating circuit, the headset, and the battery power supply. (See figure 2-2). Careful consideration of trouble symptoms will usually make it possible to localize the trouble to one or more of the above circuit groups.

Because both aural and visual indications of radiation intensity are provided, troubles can be readily localized by observing whether the fault affects the indicating meter

reading, the clicks in the headset, or both. If the headset is inoperative when the meter is indicating the presence of radiation correctly, the fault must lie in the headset and its associated components. If the meter is inoperative when clicks are being obtained in the headset, the fault must lie in the meter and associated circuits. However, if neither the headset nor the meter respond, the fault must lie in the circuits common to both. In this case, replace Z-101, V-104, V-103, V-102, and V-101, one at a time, in the sequence listed, and check for proper operation after each replacement. If the fault persists, replace the original parts, then use the data contained in the voltage-resistance chart (figure 7-1) and in the waveform chart (figure 7-2) and table 7-1 to trouble shoot the pulse shaper and amplifier circuit, the high-voltage power supply circuit, the integrating and indicating circuit, and the G-M tubes.

If the radiacmeter is inoperative or gives erratic indications on one or two of the ranges only, the trouble can be readily localized by reference to the complete schematic diagram of the radiac set (figure 7-4). Trouble on one range only indicates that section S-101C of the range switch or the associated resistors are defective. Troubles on both the 0.5 and 5 mr/hr ranges indicate that V-102 or the probe cable is defective; similarly, trouble on both the 50 and 500 mr/hr ranges indicates the V-101 is defective.

Note that the voltages applied to the G-M tubes and the pulse shaper and amplifier circuit are regulated. This is done in order to prevent erratic readings as a result of battery aging and other causes. Therefore, if meter readings are erratic, look for trouble in the voltage regulator circuits.

3. VOLTAGE-RESISTANCE CHART (See figure 7-1).

Magnitudes of voltage and resistance to ground from the pins at the socket of plug-in unit Z-101 and all accessible tubes are contained in the voltage-resistance chart. The conditions under which these readings should be obtained are given on figure 7-2.

CAUTION

Remove batteries from the radiacmeter before measuring resistances. Failure to observe this precaution may damage the ohmmeter as well as meter M-101.

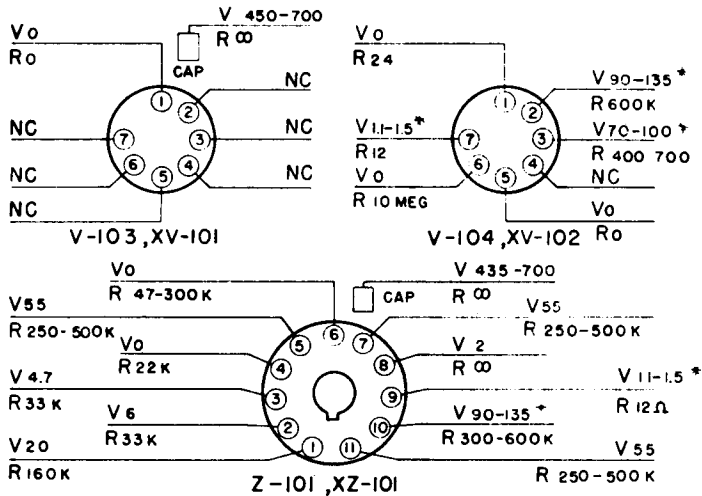

Fig. 7-1 Voltage Resistance Chart

CONDITIONS OF MEASUREMENT

1. ALL MEASUREMENTS MADE FROM INDICATED POINT TO CHASSIS. BOTTOMS OF SOCKETS ARE SHOWN.
2. ALL VOLTAGE MEASUREMENTS MADE WITH A 20,000-OHM-PER-VOLT, D.C. METER, WITH RANGE SWITCH S-101 SET AT 500.
3. ALL VOLTAGES ARE POSITIVE WITH RESPECT TO CHASSIS UNLESS THEY ARE MARKED "-" FOR NEGATIVE.
4. ALL RESISTANCE MEASUREMENTS MADE WITH BATTERIES REMOVED, AND WITH RANGE SWITCH S-101 SET AT 500. READINGS ARE $\pm 20\%$.

NOTES

NC - NO CONNECTION

* - READING VARIES WITH BATT.CONDITION.

WAVEFORM	OSCILLOSCOPE LEAD CONNECTED TO	RANGE SWITCH POSITION	APPRX AMPLITUDE (VOLTS peak-to-peak)	RADIOACTIVE TEST SAMPLE USED	REMARKS
	PLATE LEAD OF V-104 (OVER INSULATION, NO DIRECT CONNECTION)	500	2.0	NO	CLIP OSCILLOSCOPE LEAD OVER INSULATION. (no direct contact)
	GRID, V-104	500	27.0	NO	NONE
	PIN 3, V-104	50	48.0	NO	NONE
	CAP, Z-101	500	—	YES	AMPLITUDE MAY VARY BETWEEN 0.5-VOLT AND 50 V.
	PIN 6, Z-101	50	13.0	YES	NONE
	J-101	500	4.8	YES	HEADSET DISCONNECTED

USE OSCILLOSCOPE SUCH AS TS-34/AP OR TS-230/UP SERIES OR EQUIVALENT

Fig. 7-2 Waveform Chart

TABLE 7-1. TROUBLE SHOOTING CHART

Symptom	Probable Location of Fault	Procedure
1. Meter reads zero with range switch at BATT COND.	Battery connections	Check battery connections for corrosion and loose or broken leads.
	Range switch S-101	Check contacts on S-101A, S-101B and S-101C (Front and Rear). Clean or tighten contacts, if necessary.
	Meter M-101 or multiplier R-111	Check R-111 and M-101.
2. No clicks in headset on any range when unit is tested with radioactive test sample. (Continued on next page)	Headset	Check headset.
	High-voltage supply circuit	Measure voltage from cap of V-103 to ground, using electronic voltmeter or 20,000-ohms-per-volt voltmeter. If it is less than 435 volts, measure voltages and resistances at socket of V-104.
	Plug-in unit Z-101	Check voltages at socket of Plug-in unit Z-101. If incorrect, replace Z-101. If fault persists, replace original plug-in unit. Check R-101.

TABLE 7-1. TROUBLE SHOOTING CHART (cont.)

Symptom	Probable Location of Fault	Procedure
2. (Continued from preceding page)	Range switch S-101, headset jack J-101	Check contacts of S-101. Clean or tighten contacts if necessary. Check J-101 and C-102.
3. Clicks in headset, but no meter indication on any range when unit is tested with radioactive test sample.	Integrating and indicating circuit.	Check voltages at socket of plug-in unit Z-101; if incorrect, replace Z-101. If fault persists, restore original plug-in unit, then check C-103, S-101A, S-101B and S-101C.
4. No clicks in headset, on one or more ranges when unit is tested with radioactive test sample.	G-M tubes	If fault occurs in both 0.5 and 5 mr/hr range, replace V-102; if fault persists, check probe cable. If fault occurs in both 50 and 500 mr/hr ranges, replace V-101. If fault persists, restore original tubes.
	Range switch S-101 or calibrating resistors.	Check contacts on S-101A and S-101C; Clean or tighten if necessary. Check R-103 through R-110.

TABLE 7-1. TROUBLE SHOOTING CHART (conf.)

Symptom	Probable Location of Fault	Procedure
5. Constant meter reading on all ranges, independent of radiation intensity.	Plug-in unit Z-101.	Replace Z-101.
6. Meter reading erratic or abnormally high when unit is tested with radioactive test sample.	Plug-in unit Z-101.	Check voltages and waveforms at socket of Z-101; if incorrect, replace Z-101. If fault persists, restore original plug-in unit.
	Range switch S-101 or calibrating resistors.	Check contacts on S-101A, S-101B and S-101C ;clean and tighten if necessary. Check R-103 through R-110. Check V-103.
7. Meter scales do not change when range switch is rotated.	Meter card positioning mechanism.	Check sprocket chain and its spring. Tighten setscrews on sprocket gears.
8. Meter face not illuminated when radiacmeter is tilted.	Meter illuminating circuit.	Check E-105, S-102, and R-116.

4. WAVEFORM CHART --(See figure 7-2)

Waveforms obtained at significant points in the radiac-meter are shown in the waveform chart. Be sure to duplicate these conditions accurately when observing the waveforms; if this is not done, the waveforms obtained may differ from those shown even though the equipment is operating correctly.

5. TROUBLE SHOOTING CHART --(See Table 7-1).

Commonly encountered trouble symptoms, probable location of faults and procedures for locating defective components are contained in the trouble shooting chart.

6. CALIBRATION

NOTE

Calibration is to be performed at calibration stations only.

a. GENERAL--Radiac Set AN/PDR-27A was calibrated when manufactured. Recalibration may be necessary after replacement of plug-in unit Z-101 or one of the G-M tubes but, ordinarily, is not necessary when other components or tubes are replaced. Calibration is a tedious and difficult undertaking, and should not be done unless extreme accuracy of indication is required.



Figure 7-3. Calibration Control Panel

The following equipment is required for complete calibration of the radiac set:

1. An accurately calibrated radium source weighing two (or more) milligrams.
2. Accurate rulers or tapes for measuring the distance between the radium source and the radiacmeter.
3. A special radiacmeter housing containing four holes that permit access to the calibration potentiometers.
4. Calibration must be performed in an area free of large metallic objects. This precaution is necessary in order to avoid inaccuracies in the calibration due to secondary radiation effects.

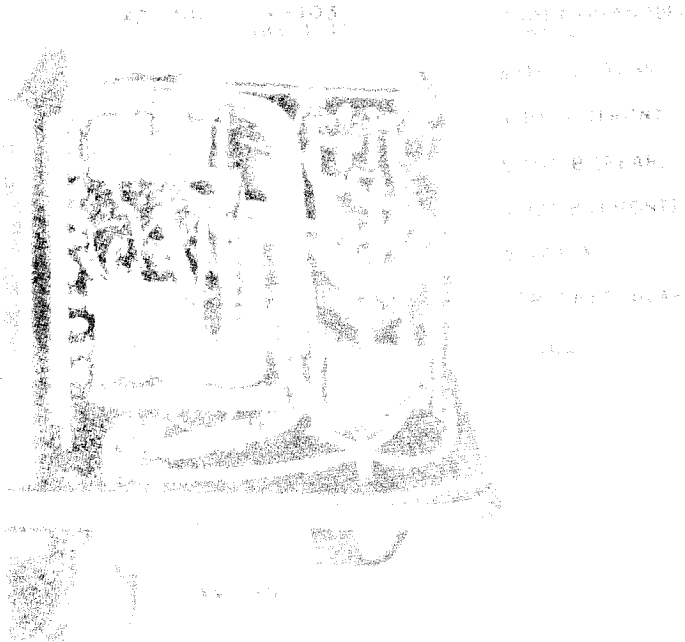

Figure 7-4. Radiacmeter
IM-63/PDR-27A Left Side with V-104 Removed

b. CALIBRATION PROCEDURE

WARNING

Calibration of this equipment necessitates the use of a radium source. Exercise due caution in the handling of the source. Obey all radiation safety precautions. Perform the calibration as rapidly as possible to avoid prolonged exposure to the radiation.

Step 1. Loosen the six screws securing the radiacmeter panel to the housing. Remove the housing and replace it with the special housing. Check the battery condition. Check to see that the beta shield covers the end of the radiac detector, then slip the detector into the well of the radiacmeter.

Step 2. Arrange the equipment as indicated in figure 7-5. Measure and adjust each distance carefully, then observe the radiacmeter indication; if it differs by more than 1M from the specified value, adjust the proper calibration potentiometer until the correct value is indicated on the meter. If the weight of the radium source is not two milligrams, or if it is desired to calibrate the radiacmeter at intensities not shown in figure 7-5, use the following formula to find the relation between meter indication and distance between radiacmeter and radium source:

$$\text{mr/hr} = \frac{1333 \times W}{D^2}$$

where

mr/hr = radiation intensity in milliroentgens per hour.

W = weight of radium source in milligrams.

D = distance between radiacmeter and radium source in inches.

Step 3. After all four ranges have been adjusted, turn the range switch to OFF. Then remove the special housing from the radiacmeter. Stake the four calibration potentiometers by applying electrical insulating varnish Navy specification 52-V-13 Grade CA (SNSN 52-V-1240 for a 1 pint can, 52-V-1255 for a one gallon can) with a small brush such as SNSN 38-B-2005.

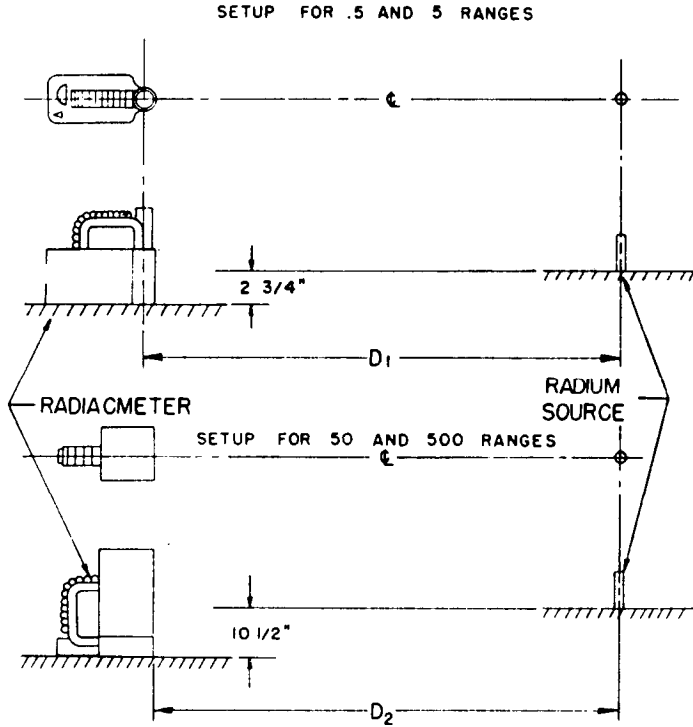

CHECK	RANGE	D ₁ INCHES (± 1/4)	D ₂ INCHES	ADJUST	TO READ MR/HR
1	.5	81.6	————	R-110	.40
2	5	25.8	————	R-104	4.0
3	50	————	7.72	R-106	40
4	500	————	2.14	R-108	400

NOTE: ABOVE VALUES APPLY ONLY TO CALIBRATION BY
2 - MILLIGRAM RADIUM SOURCE.

Fig. 7-5 Calibration Set Up Data

7. REMOVAL AND REPLACEMENT OF PARTS.

(G.M. tube in probe)

a. REMOVAL OF V-102. (See fig. 7-6)

Step 1. Turn the range switch to OFF.

Step 2. Lift the radiac detector out of well.

Step 3. With your fingers, spread the ears of the beta shield and remove the shield.

Step 4. Unscrew the retaining ring with special wrench symbol H-103 stowed in carrying case (See fig. 1-1); Remove the ring.

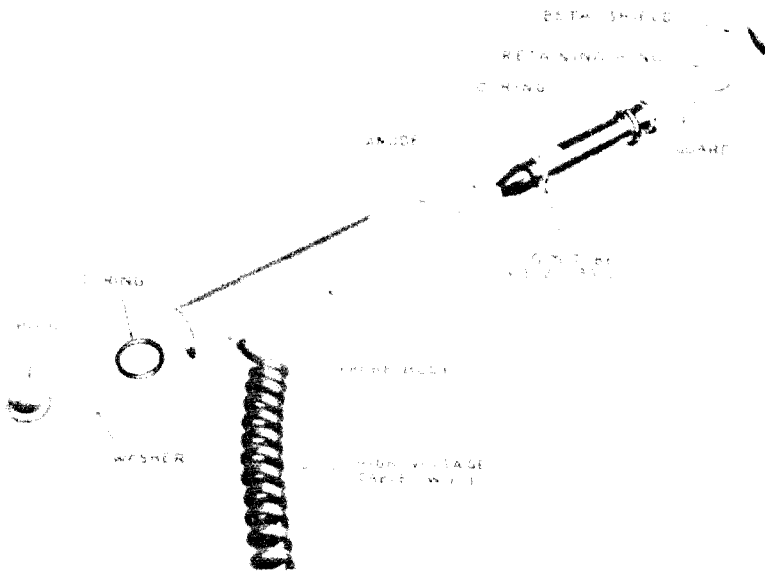

Figure 7-6.

Radiac Detector DT-53/PDR-27A, Exploded View

Step 5. Being careful not to damage the mica window of V-102, lift out the guard.

CAUTION

The mica window of V-102 is 0.0005 inch thick. Do not touch this window under any conditions. Damage to the tube will result.

Step 6. Unscrew the plug at the end of the radiac detector probe by using the rounded end of the special wrench. Remove the plug; be careful not to lose the washer and the "O" ring.

Step 7. Using long-nosed pliers, remove the anode clip from the V-102 anode.

Step 8. With your thumb, push the anode lightly into the housing, causing V-102 to slide out of the front end of the probe housing.

b. REPLACEMENT OF V-102 (See fig. 7-6)

Step 1. Slip the "O" ring over the anode end of V-102, then roll the ring along the tube to within 1/2-inch of the flange near the mica window.

Step 2. Slide V-102 into the housing until it is stopped by the "O" ring.

Step 3. With your fingers, press on the flange of V-102. Take care not to touch the mica window. Exert light pressure until V-102 rolls into the housing.

Step 4. Replace the guard, and screw the retaining ring into the housing. Using the flat end of the special wrench, tighten the retaining ring.

Step 5. Using long-nosed pliers, place the anode clip on the V-102 anode.

Step 6. Insert the "O" ring in the rear of the housing.

Step 7. Slip the washer on the end of the plug, and screw the plug into the rear of the housing. Using the rounded end of the special wrench, tighten the plug.

Step 9. Replace the beta shield on the front of the probe.

8. COMPONENT CHARACTERISTICS

a. ELECTRON TUBES--Table 7-2 lists the operating voltages and currents of all accessible tubes in the radiac set. Note that data for the tubes in plug-in unit Z-101 have not been included. Table 7-3 lists the characteristics of the accessible tubes in the radiac set. Data for the tubes in the plug-in unit have not been included.

NOTE

All tubes of a given type supplied with the equipment shall be consumed prior to employment of tubes from general stock.

b. WINDING DATA--Winding data for inductor L-101 are contained in Table 7-4.

TABLE 7-2. TUBE OPERATING VOLTAGES AND CURRENTS

Tube Type	Function	Plate (V) (1)	Plate (Ma)	Screen (V) (1)	Screen (Ma)	Cath. (V) (1)	Grid (V) (1)	D-C Heater (V)
3V4	High-Voltage Power Supply Amplifier Tube	135 to 100	1.6 (1)	100 to 75	0.135 (2)	0 (3)	-1	1.5 to 1.0
BS-1	Radiation Detector	700 to 435 (4)	0			0		
BS-2	Radiation Detector	700 to 435 (5)	0			0		
BS-101	High-Voltage Regulator	700 to 450	0.015 to 0.030			0		

- (1) Readings taken with 20,000-ohm-per-volt voltmeter plate to cathode
 (2) Very wide variation
 (3) At pin #5

- (4) With S-101 set at .5 or 5; otherwise 0.
 (5) With S-101 set at 50 or 500; otherwise 0.

TABLE 7-3. RATED TUBE CHARACTERISTICS

Tube Type	3V4	BS-1	BS-2	BS-101
Filament Voltage (V)	1.4 (1/2 fil. used)			
Filament Current (A)	.050			
Plate Voltage (V)	90	700	700	700
Grid Bias (V)	- 4.5			
Screen Voltage (V)	90			
Plate Current (Ma)	7.7	(Too small to be measured)	(Too small to be measured)	0.020
Screen Current (Ma)	1.7			
A-C Plate Resistance (Ohms)	120,000			
Transconductance (Micromhos):				
Normal	2,000			
Minimum	1,500			

7 Section

CORRECTIVE
MAINTENANCE

7-16

ORIGINAL

TABLE 7-4. WINDING DATA

Designation Symbol	Kelley Koett Part No.	Diagram	Winding	Wire	Turns	D-C Resistance (Ohms)	Hipot D-C Volts	Remarks
L-101	IDA-4808	 1 2	Single	No. 36 Formex Insulated	4400	400	3000	Inductance 18 henries at 3 ma

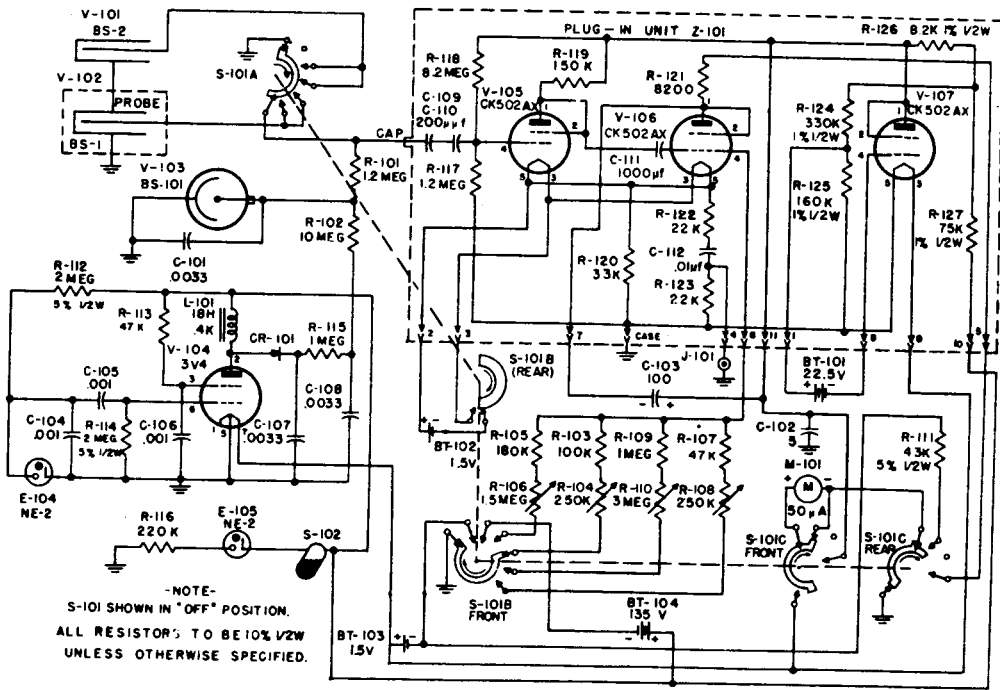

Fig. 7-7 Radiacmeter IM-63/PDR-27A, Schematic Diagram

SECTION 8
PARTS LISTS

TABLE 8-1. LIST OF MAJOR UNITS

Symbol Designation Group	Name of Major Unit	Navy Type Designation	Standard Navy Stock Number
100-199	Radiacmeter	IM-63/PDR-27A	N 16-R-18140-8426
200-299	Radiac Detector	DT-53/PDR-27	N 16-D-19877-5501
300-399	Case	CY-963/PDR-27A	N 16-C-170001-358
	Harness	ST-119/PDR-27	N 16-H-250001-107
	Radioactive Test Sample	MX-1083/PDR-27	N 16-C-14240-7925
	Headset	H-43/U	N 17-H-52047-2108

TABLE 8-2. TABLE OF REPLACEABLE PARTS

Symbol Desig.	Name of Part and Description	Function	JAN and (Navy Type) No.	Federal and (Signal Corps) Stock No.	Migr. and Migrs. Designation	Contractors drawing and Part No.	Standard Navy Stock No.	All Symbol Desig. Involved
A-101	Radiometer, Subassembly Aluminum, OD enamel finish; rectangular shape with integrally cast batt compartment; 10-5/8" lg x 5-7/8" wd x 4-1/4" d; 6-.169" diam. mtg holes	Panel for meter and electronic chassis				Kelley-Koett part/dwg #IDE-4875	*N16-R-18301-1012	A-101
A-102	Cover, Panel: Aluminum OD enamel finish; rectangular shape with cast probe compartment; 12-1/8" lg x 5-7/8" wd x 4-5/16" d	Waterproof cover for meter and electronic chassis				Kelley-Koett part/dwg #IDD-4829-1	*N16-C-850001-352	A-102
A-102A	Calibrating Test Jig: Same as A-102 except for 4-1/2" diam. access holes for adjusting calibration potentiometers	Cover for electronic chassis during calibration		3MC 30		Kelley-Koett part/dwg #IDD-5059		A-102A
A-103	Cover, Battery Box: Aluminum, OD enamel finish 7-11/32" lg x 5-5/8" wd x 3-3/16" h; 4-#8-32 tapped mtg holes on 3-1/2" x 3-1/2" mtg ctrs	Handle and cover for battery compartment		223351-261		Kelley-Koett part/dwg #IDD-4818-5	*N17-C-945001-864	A-103
A-104	Contact Ass'y Electrical: Mica filled phenolic w/silver plated phosphor bronze batt contacts: 4-1/16" lg x 3" wd x 1-3/4" d; holds BT-102 and BT-103	Holds fill batteries and provides a means for making connection to these batteries		3B410		Kelley-Koett part/dwg #IDC-4899	N17-C-83589-5211	A-104
A-201	Housing, Probe: Aluminum alloy, clear anodized; 1-3/8" diam. x 7-11/16" lg o/a; marked DT-53/PDR-27	Probe shell		3MC 32		Kelley-Koett part/dwg #IDC-4778	N16-H-800001-166	A-201

*This item not available as a maintenance part in Naval supply activities. If failure occurs, do not request replacement (unless the item cannot be repaired or fabricated)

Symbol Desig.	Name of Part and Description	Function	JAN and (Navy Type) No.	Federal and (Signal Corps) Stock No.	Mfg. and Mfgs. Designation	Contractors drawing and Part No.	Standard Navy Stock No.	All Symbol Desig. Involved
A-202	Plug, Machine Thread: Brass cadmium plated; 1.170" diam. x 13/32" thk external 24 pitch thread	Closes cable end of probe		6Z7598-9		Kelley-Koett part/dwg #IDA-4779	N17-P-60948-4050	A-202
C-101	Capacitor, Fixed, paper Dielectric: 0.0033 mf $\pm 20\%$; 1600 vdcw; 1-9/32" lg x 7/16" diam; 2 axial wire lead term; p/o Z-102; molded phenolic case	High Voltage Filter Capacitor		3DA3.300-2	Sprague Type #MB-23	Kelley-Koett part/dwg #IDA-4803	N16-C-40595-3285	C-101, 107, 108
C-102	Capacitor, Fixed, Electrolytic: 5 mf $\pm 100\%$ -10% 150 vdcw; 1-1/2" lg x 7/16" diam; 1 axial and 1 radial wire lead term; p/o Z-102; hermetically sealed metal case	Shunt Regulator storage capacitor		3DB5-112	Dubilier Type BBR5-150	Kelley-Koett part/dwg #IDA-4810	N16-C-19463-7552	C-102
C-103	Capacitor, Fixed, Electrolytic: 100 mf. $\pm 100\%$ -10% 1.5 vdcw; 1-1/8" lg x 7/16" diam; 1 axial, 1 radial wire lead terminal, p/o Z-102; hermetically sealed metal case	Integrating Capacitor		3DB100-52	Dubilier Type BBR100-15	Kelley-Koett part/dwg #IDA-4811	N16-C-20175-8375	C-103
C-104	Capacitor, Fixed, Mica Dielectric: 1000 mmf $\pm 5\%$; 300 vdcw; 51/64" Max. lg x 15/32" Max. wd. x 1/4" thk; 2 axial wire lead terminals; p/o Z-102	Charging capacitor for saw tooth generator		3DAI-318	Micamold Type OXM	Kelley-Koett part/dwg #IDA-4801	N16-C-31085-2037	C-104, 111
C-105	Same as C-104 except $\pm 20\%$ tolerance	Coupling capacitor for V-104 grid		3DAI-319	Micamold Type OXM	Kelley-Koett part/dwg #IDA-4802	N16-C-31095-5097	C-105, 106
C-106	Same as C-105	V-104 screen by pass						C-105, 106

Symbol Desig.	Name of Part and Description	Function	JAN and (Navy Type) No.	Federal and (Signal Corps) Stock No.	Mfg. and Mfgs. Designation	Contractors drawing and Part No.	Standard Navy Stock No.	All Symbol Desig. Involved
C-107	Same as C-101	High voltage filter capacitor						C-101, 107, 108
C-108	Same as C-101	High voltage filter capacitor						C-101, 107, 108
C-109	Capacitor, Fixed, Ceramic Dielectric: 200 mmf $\pm 20\%$, 500 vdcw; 0.562" lg x 0.250" diam; 2 axial wire term	p/o Z-101			Erie GP2K	Kelley-Koett part/dwg #IDA-4838	N16-C-17699-7215	C-109, 110
C-110	Same as C-109	p/o Z-101						C-109, 110
C-111	Same as C-104	p/o Z-101						C-104, 111
C-112	Capacitor, Fixed, Paper Dielectric: 0.01 mf $\pm 20\%$, 200 vdcw; 7/16" lg x 3/16" diam; 2 axial wire lead terminals; molded phenolic case	p/o Z-101			Aerovox Type P-83	Kelley-Koett part/dwg #IDA-4844	N16-C-42763-2616	C-112
E-101	Board, Terminal: Feed thru insulator for batt compartment; 8 plated brass double ended lugs in a line; mounted on 3-.144" diam. holes; 1-3/8" center center distances	Feed battery leads thru battery compartment wall		32770-8.87		Kelley-Koett part/dwg #IDB-4898	N17-B-77839-2151	E-101
E-102	Board, Terminal: Mounting for high voltages supply components; 24 turret type solder lugs; 4-1/2" lg x 3-1/2" wd x 3/4" thk o/a; Mounts on 3 spade type lugs	p/o Z-102				Kelley-Koett part/dwg #IDC-4870	N17-B-78206-9720	E-102
E-103	Board, Terminal: Mounting for calibration controls 3 terminals; 4" lg x 3" wd x 3/4" thk; mts on 5 irregularly located holes	p/o Z-103				Kelley-Koett part/dwg #IDB-4898	N17-B-77591-1376	E-103

ORIGINAL

8-5

Symbol Desig.	Name of Part and Description	Function	JAN and (Navy Type) No.	Federal and (Signal Corps) Stock No.	Mfg. and Mfgs. Designation	Contractors drawing and Part No.	Standard Navy Stock No.	All Symbol Desig. Involved
E-104	Lamp, Glow: 90 vdc striking, 1/25 w; bulb T-2 clear; 1-1/16" lg o/a wire terms; neon	Discharge tube for sawtooth generator		225954	G E Type NE-2	Kelley-Koett part/dwg #IDA-1523	N17-L-6806-120	E-104, 105
E-105	Same as E-104	Meter Illumination						E-104, 105
E-106	Knob: Pointer type; plastic; 1/4" shaft; 1-#8-32 set screw; single white index line; 1-1/4" lg x 3/4" wd x 11/16" thk	Off. batt cond. and range switch knob		225821-165	Rogan Bros Type RB-41	Kelley-Koett part/dwg #IDA-4830	N16-K-700065-926	E-106
H-101	Chain: Sprocket, ladder type; 0.185" pitch x 7/64" wd; brass cadmium plated; 26 lb yield point; 5" lg; Boston Gear Type #1A; used w/0-103	Drives meter scale changing mechanism		621806-12.3	Boston Gear Type 1A	Kelley-Koett part/dwg #IDA-4853	N17-C-480693-236	H-101
H-102	Nut, Packing: Brass Cadmium plated; 3/8" -32 thread; 1/4" h x 3/8" across flats o/a; 1/4" diam. axial hole	Probe cable packing gland nut		6L3800-4		Kelley-Koett part/dwg #IDA-4798	N16-N-68031-5369	H-102, 201
H-103	Washer, Flat: brass cadmium plated; 1/4" ID x 11/32" OD x 0.020" thk; used w/H-102	Probe cable gland washer		6L 50114-15		Kelley-Koett part/dwg #IDA-4781	N17-W-180001-129	H-103, H-203
H-104	Catch, Fastener: harness catch brass cadmium plated; 5/8" lg x 3/8" diam. o/a; 1/4" lg #10-32 stud one end	Fastens harness to Radiacmeter		623810-4.2		Kelley-Koett part/dwg #IDA-4795	*N16-C-200001-119	H-104, H-105
H-105	Same as H-104							H-104, H-105

*This item not available as a maintenance part in Naval supply activities. If failure occurs, do not request replacement (unless the item cannot be repaired or fabricated)

PARTS LIST
E-104-H-105Section
8

Symbol Desig.	Name of Part and Description	Function	JAN and (Navy Type) No.	Federal and (Signal Corps) Stock No.	Migr. and Migrs. Designation	Contractors drawing and Part No.	Standard Navy Stock No.	All Symbol Desig. Involved
H-106	Screw, Captive: Slot Drive; Stainless steel; #8-32; 5/8" lg; 5/16" length of thread; 0.135" diam. x 5/16" undercut adjacent to head	Fasten panel to cover, and batt compartment cover to handle		6L4768-10.498		Kelley-Koett part/dwg #IDA-4867	N43-S-4799-9225	H-106
H-107	Washer, Flat; Stainless steel; 11/32" OD x 0.063" thk; #8-32 tapped hole in center	Used under all captive screws (H-106)				Kelley-Koett part/dwg #IDA-5866		H-107
H-201	Same as H-102	Probe cable packing nut						H-102, H-201
H-202	Washer, Flat; Brass, SAE 7, cadmium plated; 7/8 ID x 1-3/32 OD x 1/32" thk	Used under plug A-202		6L5B034-2		Kelley-Koett part/dwg #IDA-4780	N16-W-180001-178	H-202
H-203	Same as H-103	Probe cable packing gland washer						H-103, H-203
H-204	Guard; brass, cadmium plated; 1-7/64" diam. x 1/32" thk	Protects mica window of V-102		3MC31		Kelley-Koett part/dwg #IDA-4783	N16-G-930001-132	H-204
H-301	Wrench, special: stainless steel; 4" lg x 1-1/16" wd x 0.078" thk; one square end and one curved end	Used for plug, and locking ring in probe		6R57690-1		Kelley-Koett part/dwg #IDA-4961	*N16-W-920001-140	H-301

*This item not available as a maintenance part in Naval supply activities. If failure occurs, do not request replacement (unless the item cannot be repaired or fabricated)

Symbol Desig.	Name of Part and Description	Function	JAN (and Navy Type) No.	Federal and (Signal Corps) Stock No.	Migr. and Migrs. Designation	Contractors drawing and Part No.	Standard Navy Stock No.	All Symbol Desig. Involved
H-302	Wrench, set screw: Steel .050" across flats; for #4 socket head set screws	Used for set screw in meter sprocket		6R57400-6	Allen Mfg Co.	Kelley-Koett part/dwg #IDA-5395	N41-W-2443-10	H-302
H-303	Wrench, set screw, steel 5/64" across flats, for #8 socket head set screws	Used for set screw on knob			Allen Mfg Co.	Kelley-Koett part/dwg #IDA-5398	N41-W-2443-10	H-303
J-101	Connector: female contact; 1 round contact; straight; 3/8" OD x 1-1/16" lg o/a	Panel connector for Headset	UG-290/U	2Z7390-290	Industrial Products Co. Type #IPC-2700	Kelley-Koett part/dwg #IDA-4806	N17-C-73108-1267	J-101
L-101	Reactor; 18 hy. 3 ma; 400 ohms DC resistance; 3000 vdc; open frame; 2-5/32" lg x 1-3/4" wd x 1-5/8" h; 2-.177" holes on 1-1/8" mtz/c; 2 solder lug term on side	V-104 plate load		3C577-43	G E part No. 112J 78	Kelley-Koett part/dwg #IDA-4806	N16-R-29347-1210	L-101
M-101	Meter: Roentgen Rate; range 0-.5, 0-5, 0-50, 0-500 mr/hr; rectangular plastic case; 3-3/4" lg x 3-1/2" wd x 1-9/16" d; 12%; D' Arsonval movement; 50 microamp full scale, 80 miv drop; 50 scale divisions, black numerals on white, green, yellow, or red background; scale changing type actuated; by 1/4" diam x 1/2" lg shaft on rear; external electronic ckt required for operation; 4 mtg holes 0.180" diam on 3-15/32" x 1-15/16" ctrs.	Indicating meter for battery condition and radiation intensity	Navy Type CAY-22734	3F3306-1	Wemco Style 1538213	Kelley-Koett part/dwg #IDB-4815	N17-M-32164-7084	M-101

Symbol Desig.	Name of Part and Description	Function	JAN and (Navy Type) No.	Federal and (Signal Corps) Stock No.	Migr. and Migrs. Designation	Contractors drawing and Part No.	Standard Navy Stock No.	All Symbol Desig. Involved
N-101	Label, Identification: decalcomania; white lettering, black background; 3" lg x 2" wd o/a	Identification plate for Radiacmeter		227091-464		Kelley-Koett part/dwg #IDB-4969	N16-L-110001-108	N-101
N-301	Plate, Identification: Aluminum, w/black background and aluminum lettering; 3" lg x 2" wd x 0.032" thk; 4-1/8" mtg holes on 2.750" x 1.750" centers	Identification for case	CY-963/PDR-27A			Kelley-Koett part/dwg #IDB-4974	N16-P-403501-605	N-301
N-302	Plate, Identification: Aluminum, w/black background and aluminum lettering; 4" lg x 3" wd x 0.032" thk; 4-1/8" mtg holes on 3-3/4" x 2-3/4" ctrs	Identification for Radiac Set	AN/PDR-27A			Kelley-Koett part/dwg #IDB-4970	N16-P-403501-606	N-302
N-303	Book, Instruction:	Operation and Maintenance Instructions		3M3-27A			N16-B-669881-166	N-303
O-101	Sprocket, Chain; Steel Cadmium plated; no dimension greater than 1 inch; 12 teeth 0.710 pitch diam; 1/4" shaft holes; 2-64-40 Hex drive; cup point, set screws	Drives meter scale changing mechanism		228880-21	Boston Gear Type CA-12 teeth	Kelley-Koett part/dwg #IDA-4847	N17-S-500031-121	O-101, O-102
O-102	Same as O-101							O-101, O-102
O-103	Spring; Helical, extension: 0.020" diam music wire; 3/4" lg x 0.175" diam; 18 turns double loop ends; used 2/R-101	Removes slack in chain for meter scale changing mechanism		228877.588		Kelley-Koett part/dwg #IDA-4852	N17-S-46726-8191	O-103

Symbol Desig.	Name of Part and Description	Function	JAN and (Navy Type) No.	Federal and (Signal Corps) Stock No.	Mfg. and Mfgs. Designation	Contractors drawing and Part No.	Standard Navy Stock No.	All Symbol Desig. Involved
O-104	Gasket: neoprene; "O" ring type; 0.250" ID x 0.375" OD x 0.063" diam	Switch Shaft Seal		224668.887	Precision Rubber Prod. #PRP-902-5	Kelley-Koett part/dwg #IDA-4888	N17-G-160980-101	O-104
O-105	Seal, neoprene; "O" ring type; 5/32" ID x 9/32" OD x 1/16" diam	Panel screw gasket		224668.888	Precision Rubber Prod. #PRP-902-5	Kelley-Koett part/dwg #IDA-1888	N16-S-150143-104	O-105 O-107
O-106	Not Used							O-106
O-107	Same as O-105	Batt compartment feed thru screw gasket						O-107, O-105
O-108	Not Used							O-108
O-109	Not Used							O-109
O-110	Not Used							O-110
O-111	Gasket: neoprene; "O" ring type; 9-1/2" ID x 9-3/4" OD x 1/8" diam	Panel to cover sealing gasket		224668.889	Precision Rubber Prod. #PRP-909-50	Kelley-Koett part/dwg #IDA-4906	N17-G-164829-250	O-111
O-112	Gasket: neoprene; "O" ring type; 6-1/4" ID x 6-1/2" ID x 1/8" diam	Batt compartment cover sealing gasket		221868.890	Precision Rubber Prod. #PRP-909-37	Kelley-Koett part/dwg #IDA-4907	N17-G-163723-350	O-112
O-113	Clip, Tube Clip: 23/32" lg x 5/8" wd x 5/8" thk; steel, cadmium plated; 1-1/8" diam mtg hole	Retains V-103		222712.76	Mallory #TH-17	Kelley-Koett part/dwg #IDA-4821	N17-C-612511-169	O-113

Symbol Desig.	Name of Part and Description	Function	JAN and (Navy Type) No.	Federal and (Signal Corps) Stock No.	Mfgr. and Mfgrs. Desig- nation	Con- tractors drawing and Part No.	Standard Navy Stock No.	All Symbol Desig. Involved
O-114	Gasket; neoprene; flat type, rectangular shape w/rounded ends; 3 holes 5/32" diam 2 elongated holes 7/32" wd x 15/32" lg; used w/R-101	Seal for Battery compartment feed-thru terminal strip		2Z4868. 891		Kelley-Koett part/dwg #IDA-4905	N17-G-152599-993	O-114
O-115	Retainer, Electron Tube: steel, cadmium plated; 1-7/8" h x 1" wd x 11/16" thk o/a; one mtg hole 0.132" diam; for 7 pin miniature tubes; included a conical spring to maintain pressure on tube	Retains V-104		2Z7780-86	Staver Mfg Co. #21D	Kelley-Koett part/dwg #IDA-4846	N16-R-503580-188	O-115
O-116	Lead, Electrical: 19/32" lg x 7/16" diam; plastic insulation; one connection for 1/4" diam grid cap one insulated wire lead	Anode cap for V-103		2Z2712. 211	Alden #915L	Kelley-Koett part/dwg #IDA-4837	N17-L-62615-9906	O-116
O-117	Clip, Electrical: beryllium copper, silver plated 1/2" lg x 7/16" wd x 1/4" thk; one crimp type solder lug connection; for 0.080" contact pins	Contact clip for Z-101		2Z2712. 213	Millen #38021	Kelley-Koett part/dwg #IDA-4834	N17-C-80013-251	O-117
O-118	Packing, neoprene; flat type; 1/4" ID x 5/16" OD x 1/8" thk	Probe cable stuffing tube gasket		2Z4868. 893		Kelley-Koett part/dwg #IDA-4782	#N17-P-125001-304	O-118, O-203
O-201	Gasket: "O" ring type; neoprene; 1-1/8" OD x 7/8" ID	Front probe seal		2Z4868. 892	Precision Rubber Prod. #PRP-902-17	Kelley-Koett part/dwg IDA-4797	N17-G-161206-390	O-201, O-202

*When equipment spares are expended do not request replacement from Naval Supply activities. This item should be fabricated; if additional parts are required.

Symbol Desig.	Name of Part and Description	Function	JAN and (Navy Type) No.	Federal and (Signal Corps) Stock No.	Migr. and Migrs. Designation	Contractors drawing and Part No.	Standard Navy Stock No.	All Symbol Desig. Involved
O-202	Same as O-201	Rear probe seal			Precision Rubber Prod. #PRP-902-17	Kelley-Koett part/dwg #IDA-4797		O-201, O-202
O-203	Same as O-118							O-118, O-203
O-204	Not used							O-204
O-205	Ring, Retainer; Brass cadmium plated 1.179" OD x 7/8" ID x 1/4" thk; external 24 pitch thread; spanner wrench slots on one face	Retains Guard and V-102 in radial detector		227858-192		Kelley-Koett part/dwg #IDA-4784	N16-R-651091-273	O-205
O-206	Shield, Radiac Detector; Brass, cadmium plated; 1-3/32" lg x 1-3/8" diam x 3/32" thk; mts with 2 spring detent tabs	Beta shield for probe		3MC29		Kelley-Koett part/dwg #IDB-4786	N16-S-35921-1007	O-206
O-207	Clip, Electrical; spring brass, solder coated; 1/2" lg x 5/16" wd x 1/4" h o/a; for 1/4" anode cap	Anode clip for V-102		2Z2712.212	Cinch #60D	Kelley-Koett part/dwg #IDA-4884	N17-C-800113-301 (For Replacement Use N17-C-800231-330)	O-207
O-301	Cushion, spare parts: molded sponge neoprene; 6" lg x 4-3/8" wd x 2" thk; 6 cylindrical compartments and 1 rectangular compartment	Provides rack for storing spare parts in case				Kelley-Koett part/dwg #IDC-4963	N17-C-965001-275	O-301
P-101	Connector, Plug, 8 contact male; octal style w/double keys, 135° apart	Plug connector for BT-101		2Z3028-56	Eby #97063	Kelley-Koett part/dwg #IDB-4891-1	N17-C-71541-8241	P-101, P-102
P-102	Same as P-101	Plug connector for BT-104						P-101, P-102

Symbol Desig.	Name of Part and Description	Function	JAN and (Navy Type) No.	Federal and (Signal Corps) Stock No.	Migr. and Migrs. Designation	Contractors drawing and Part No.	Standard Navy Stock No.	All Symbol Desig. Involved
P-103	Connector: 11 pin male contact; octal style	Part of Z-101			Amphenol 8L-CP11	Kelley-Koett part/dwg #A-4834-1		P-103
R-101	Resistor, fixed, composition: 1.2 meg $\pm 10\%$ 1/2w; 0.406" lg x 0.175" diam; 2 axial wire lead terminals	Load resistor V-101, V-102	RC20BF125K	3RC20BF125K	A-B #EB-1251	Kelley-Koett part/dwg #IDA-568		R-101, R-117
R-102	Resistor, fixed composition: 10 meg $\pm 10\%$ 1/2"; 0.406" lg x 0.175" diam; 2 axial wire lead terms: p/o Z-102	Series dropping resistor for V-103	RC20BF106K	3RC20BF106K	A-B #EB-1061	Kelley-Koett part/dwg #IDA-566	N16-R-51326-811	R-102
R-103	Resistor, fixed, composition: 0.010 meg $\pm 10\%$ 1/2w; 0.405" lg x 0.175" diam; axial wire lead terms	Grid resistor for V-106 when on 5 mr/hr range	RC20BF104K	3RC20BF104K	A-B #EB-1041	Kelley-Koett part/dwg #IDA-564	N16-R-50633-811	R-103
R-104	Resistor, Variable composition: 0.25 meg $\pm 20\%$; 1/10w; 3 solder lug terms; enclosed metal case 0.350" diam x 0.186d"; slotted round metal shaft; 0.159" diam x 0.045" lg; linear taper; 2 mtg studs #1-72 thread on 0.434 mtg/c	Calibration control, 5 mr/hr range		3Z7498-25.99	Centralab Radio hm Model 1 w/shield	Kelley-Koett part/dwg #IDA-4824	N16-R-88080-8901	R-104, R-108
R-105	Resistor, Fixed; composition: 0.18 meg $\pm 10\%$ 1/2w; 0.406" lg x 0.175" diam; 2 axial wire leads	Grid resistor for V-106 on 50 mr/hr range	RC20BF184K	3RC20BF184K	A-B #EB-1841	Kelley-Koett part/dwg #IDA-573	N16-R-50696-811	R-105
R-106	Resistor, variable composition: 1.5 meg $\pm 20\%$; 1/10w; 3 solder lug terms; metal case, 0.350" diam x 0.186d; slotted round metal shaft 0.159" diam x 0.045" lg; linear taper; 2 mtg studs #1-72 thread on 0.434" mtg/c	Calibration control, 50 mr/hr range		3Z7499-1E5.2	Centralab Radiohm Model 1 w/shield	Kelley-Koett part/dwg #IDA-4825	N16-R-88371-1001	R-106

Symbol Desig.	Name of Part and Description	Function	JAN and (Navy Type) No.	Federal and (Signal Corps) Stock No.	Mfgr. and Mfgrs. Designation	Contractors drawing and Part No.	Standard Navy Stock No.	All Symbol Desig. Involved
R-107	Resistor, fixed, composition: 47K \pm 10%; 1/2w; 0.406" lg x 0.175" diam; 2 axial wire leads	Grid Resistor for V-106 on 500 mr/hr range	RC20BF473K	3RC20BF473K	A-B #EB-4731	Kelley-Koett part/dwg #IDA-545	N16-R-50480-811	R-107
R-108	Same as R-104	Calibration control on 500 mr/hr range						R-104, R-108
R-109	Resistor, fixed, composition: 1.0 meg \pm 10%; 1/2w; 0.406" lg x 0.175" diam; 2 axial wire lead terms	Grid resistor for V-106 when on 0.5 mr/hr range	RC20BF105K	3RC20BF105K	A-B #EB-1051	Kelley-Koett part/dwg #IDA-565-1	N16-R-50975-811	R-109
R-110	Resistor, Variable, Composition; 3 meg \pm 20%; 1/10w; 3 solder lug terminals; metal case 0.832" diam x 0.186" thk; slotted round shaft 0.159" diam x 0.045" lg; linear taper; 2 mtg studs #1-72 thread on 0.434" mtg/c	Calibration control on .5 mr range		327499-5.25	Centralab Radiohm Model 1 w/shield	Kelley Koett part/dwg #IDA-4826	N16-R-88430-8980	R-110
R-111	Resistor, Fixed, Composition: 43000 ohms \pm 5%; 1/2w; 0.406" lg x 0.175" diam; 2 axial wire lead terms	Meter multiplier for Batt check	RC20BF433J	3RC20BF433J	A-B #EB-4335	Kelley-Koett part/dwg #IDA-4809	N16-R-50110-431	R-111
R-112	Resistor, Fixed, Composition: 2 meg \pm 5%; 1/2w 0.406" lg x 0.175" diam; 2 axial wire lead terms p/o Z-102	E-104 dropping resistor part of sawtooth generator	RC20BF205J	3RC20BF205J	A-B #EB-2055	Kelley-Koett part/dwg #IDA-4805	N16-R-51046-431	R-112
R-113	Same as R-107 p/o Z-102	Screen dropping resistor for V-104						R-107, R-113
R-114	Same as R-112, p/o Z-102	Grid resistor for V-104						R-112, R-114

Symbol Designation	Name of Part Description	Function	JAN and (Navy Type) No.	Federal and (Signal Corps) Stock No.	Mfr. and Mfrs. Design- nation	Con- tractors drawing and Part No.	Standard Navy Stock No.	All Symbol Desig. Involved
R-115	Same as R-109, p/o Z-102	Part of High Voltage Filter						R-109, R-115
R-116	Resistor, fixed composition: 6.22 ohms $\pm 10\%$, 1.2w, 0.406" lg x 0.175" diam, 2 axial wire lead terms	Dropping resistor for E-105	RC20BF224K	3RC20BF224K	A-B #EB-2241	Kelley-Koett part/dwg #IDA-576	N16-R-50714-811	R-116
R-117	Same as R-101	p/o Z-101						R-117, R-101
R-118	Resistor, fixed, composition: 8.2 meg $\pm 10\%$, 1.2w, 0.406" lg x 0.175" diam, 2 axial wire lead terms	p/o Z-101	RC20BF825K		A-B #EB-8251	Kelley-Koett part/dwg #IDA-592	N16-R-51281-811	R-118
R-119	Resistor fixed, composition: 15 meg $\pm 10\%$, 1.2w, 0.406" lg x 0.175" diam, 2 axial wire lead terms	p/o Z-101	RC20BF154K		A-B #EB-1541	Kelley-Koett part/dwg #IDA-570	N16-R-50678-811	R-119
R-120	Resistor, fixed, composition: 33000 ohms $\pm 10\%$, 1.2w, 0.406" lg x 0.175" diam, 2 axial wire lead terms	p/o Z-101	RC20BF333K		A-B #EB-3331	Kelley-Koett part/dwg #IDA-534	N16-R-50417-811	R-120
R-121	Resistor, fixed, composition: 8200 ohms $\pm 10\%$, 1.2w, 0.406" lg x 0.175" diam, 2 axial wire lead terms	p/o Z-101	RC20BF822K		A-B #EB-8221	Kelley-Koett part/dwg #IDA-562	N16-R-50237-811	R-121
R-122	Resistor, fixed, composition: 22000 ohms $\pm 10\%$, 1.2w, 0.406" lg x 0.175" diam, 2 axial wire lead terms	p/o Z-101	RC20BF223K		A-B #EB-2231	Kelley-Koett part/dwg #IDA-525	N16-R-50732-811	R-122, R-123
R-123	Same as R-122	p/o Z-101						R-123, R-122

ORIGINAL

8-15

Symbol Desig.	Name of Part and Description	Function	JAN and (Navy Type) No.	Federal and (Signal Corps) Stock No.	Migr. and Mgrs. Designation	Contractors drawing and Part No.	Standard Navy Stock No.	All Symbol Desig. Involved
R-124	Resistor, fixed, composition: 0.330 meg $\pm 1\%$; 1/2w; 5/8" lg x .255" diam; 2 axial wire lead terms	p/o Z-101			Wilkor Type CP 1/2	Kelley-Koett part/dwg #IDA-4840	N16-R-73246-3452	R-124
R-125	Resistor, fixed, composition: 0.16 meg $\pm 1\%$; 1/2w; 5/8" lg x .255" diam; 2 axial wire lead terms	p/o Z-101			Wilkor Type CP 1/2	Kelley-Koett part/dwg #IDA-4841	N16-R-73211-6676	R-125
R-126	Resistor, fixed, composition: 8200 ohms $\pm 1\%$; 1/2w; 5/8" lg x .255" diam; 2 axial wire lead terms	p/o Z-101			Wilkor Type CP 1/2	Kelley-Koett part/dwg #IDA-4842	N16-R-73080-3776	R-126
R-127	Resistor, fixed, composition: 75000 ohms $\pm 5\%$; 1/2w; 0.408" lg x 0.175" diam; 2 axial wire lead terms	p/o Z-101	RC20BF753J		Allen Bradley #EB-7531	Kelley-Koett part/dwg #IDA-4836	N16-R-50569-431	R-127
S-101	Switch, Rotary: 5 pole, 6 position; 3 sects; front sect 2500 vdc; silver alloy conts; 1 micalex. 2 composition sects: 1-5/16" diam x 4-3/8" lg o/a; solder lug terms; single hole mtg; 3/8"-32 bushing w/1/4" diam. shaft x 3" lg; non-shorting	Off, Batt cond, and range switch		3Z9825-62.582	Oak Type F #42065-F3	Kelley-Koett part/dwg #IDC-4608	N17-S-65465-8943	S-101, S-101A, S-101B, S-101C
S-101A	Switch Section, Rotary: micalex; front has rotor w/one long and 5 short conts	p/o S-101 High voltage switching		3Z9903E-3.58		Kelley-Koett part/dwg #IDC-4608	N17-S-91649-1020	S-101A

PARTS LIST
R-124-S-101ASection
8

Symbol Desig.	Name of Part and Description	Function	JAN and (Navy Type) No.	Federal and (Signal Corps) Stock No.	Mfr. and Mfgs. Designa- tion	Con- tractors drawing at Part No.	Standard Navy Stock No.	Part No.
S-101B	Switch, Section, Rotary; phenolic; front has rotor w/3 long and 4 short con'ts; rear has rotor w/2 short con'ts	p/o S-101 Controls batt and range circuits		3Z9903E-4.2		Kelley-Koett part/dwg #IDA-4808	N17-S-91673-1072	S-101B
S-101C	Switch, Section, Rotary; phenolic; front has rotor w/2 long and 2 short con'ts; rear has rotor w/2 long and 2 short con'ts	p/o S-101 controls meter function		3Z9903E-4.1		Kelley-Koett part/dwg #IDA-4808	N17-S-91698-1015	S-101C
S-102	Switch, Mercury; SPST; 0.5 amp. 250V; glass enclosure: 1-1/2" lg x 13/32" diam; 2-.20" diam. wire lead terms, 7/32" lg; mts in cable clamp	Meter Illumination Switch		3Z9822-7	G E type 2-52 KRD	Kelley-Koett part/dwg #IDA-4807	N17-S-56123-9176	S-102
V-101	Tube, electron; radiation counter, Geiger-Mueller type	p/o Z-102 500 mr/hr and 50 mr/hr gamma radiation detector	Navy type BS-2	2JBS-2	Amperex 151-NA	Kelley-Koett part/dwg #IDA-4882	N16-T-51993	V-101
V-102	Tube, Electron; radiation counter, Geiger-Mueller type	5 mr/hr & .5 mr/hr beta and gamma radiation detector	Navy type BS-1	2JBS-1	Amperex BS-1	Kelley-Koett part/dwg #IDA-4823	N16-T-51020	V-102
V-103	Tube, Electron; corona regulator	High Voltage regulator	Navy type BS-101	2J5962	Amperex CR-700	Kelley-Koett part/dwg #IDA-4828	N16-T-61008	V-103
V-104	Tube, Electron; pentode power amplifier	High Voltage power supply amplifier	JAN 3V4	2J3V4	RCA 3V4	Kelley-Koett part/dwg #IDA-4827	N16-T-53968	V-104

Symbol Desig.	Name of Part and Description	Function	JAN and (Navy Type) No.	Federal and (Signal Corps) Stock No.	Mfg. and Mfgs. Desig. notation	Con- tractors drawing and Part No.	Standard Navy Stock No.	All Symbol Desig. Involved
V-105	Tube, Electron, pentode	p/o Z-101			Raytheon CK-502-AV	Kelley- Koett part/dwg #IDA-4835	N16-T-65016	V-105, V-106, V-107
V-106	Same as V-105	p/o Z-101						V-106, V-105, V-107
V-107	Same as V-105	p/o Z-101						V-107, V-105, V-106 W-201
W-201	Cable Assembly, special purpose; nonkink retractile coiled type, 1 #34 tinsel conductor; 1 tinsel shield; black rubber outer jacket, retracted length 5', extended length approx. 55'; w/two terminal lugs on each end	Interconnecting cable from probe to radiacmeter		3E7350-1.55	Koiled Kurd type X192	Kelley- Koett part/dwg #IDC-4799	N17/C-48542-3321	
Z-101	Generator, Pulse; shunt regulator and single shot multivibrator; c/o V-105, V-106, V-107, C-109, C-110, C-111, C-112, P-103, R-117, R-118, R-119, R-120, R-121, R-122, R-123, R-124, R-125, R-126, R-127.	Low voltage regulator and pulse shaper		3MC7-3		Kelley- Koett part/dwg #IDC-4879	N16-61201-1025	Z-101
Z-102	Radiac, subassembly; c/o E-102, w/C-101, C-102, C-103, C-104, C-105, C-106, C-107, C-108, E-104, R-102, R-112, R-113, R-114, R-115, V-101, and CR-101 mtg thereon; 4-1/2" lg x 3-1/2" wd x 1-1/8" thk o/a; mts on 3 irregularly spaced spade lugs	High voltage power supply components terminal board				Kelley- Koett part/dwg #IDD-4881	N16-R-18301-1011	Z-102

Symbol Desig.	Name of Part and Description	Function	JAN and (Navy Type) No.	Federal and (Signal Corps) Stock No.	Mfgr. and Mfgrs. Designation	Contractors drawing and Part No.	Standard Navy Stock No.	All Symbol Desig. Involved
Z-103	Radiac, subassembly: c/o E-103, w/E-105, R-103, R-104, R-105, R-106, R-107, R-108, R-109, R-110, R-116, and L-101, mtd thereon; 4" lg x 3" wd x 2-3/8" thk o/a; mts on special bracket	Calibration controls terminal board				Kelley-Koett part/dwg #IDC-4880	N16-R-18301-1010	Z-103
BT-101	Battery, Dry: 22-1/2 volts; 1 socket type terminal, 8 contacts; 3-1/4" lg x 1-9/16" wd x 1-7/16" deep; 15 cells; sal-ammoniac paste type	Furnish reference voltage for shunt voltage regulator grid	JAN type BA-413/U		Natl Carbon	Kelley-Koett part/dwg #IDA-4877	N17-B-59196-1685	BT-101
BT-102	Battery, Dry: 1-1/2 volts; 2 flat surface type terms; 3-9/16" lg x 1-5/16" diam; 1 cell; sal-ammoniac paste type	Flt batt	JAN type BA-401/U		Natl Carbon	Kelley-Koett part/dwg #IDA-4878	N17-B-58747-3197	BT-102, BT-103
BT-103	Same as BT-102	Flt batt						BT-102, BT-103
BT-104	Battery, dry: 135 volts tapped at 22-1/2, 45, 67-1/2, 90 volts; 1 socket type terminal w/8 conts; 4-1/8" lg x 2-3/8" wd x 3-1/4" h o/a; 90 cells; sal-ammoniac paste type	Power for high voltage supply and plate supply for multivibrator	JAN type BA-416/U		Natl Carbon	Kelley-Koett part/dwg #IDA-4876	N17-B-60513-9657	BT-104
CR-101	Rectifier, metallic; selenium; input 900V peak pulse, 400 cyc prt; output 900 vdc, 50 ua max; round, 2-1/16" lg x 5/16" dia; axial wire lead terms	High Voltage Rectifier		3H4860-160	Bradley-Lab SE8L55E117	Kelley-Koett part/dwg #IDA-4804	N17-R-51614-7841	CR-101
MS-101	Glass: meter-window, 2-13/16" lg x 2" wd x 1/8" thk	Meter window				Kelley-Koett part/dwg #IDA-4800	N16-G-600001-180	MS-101

Symbol Desig.	Name of Part and Description	Function	JAN and (Navy Type) No.	Federal and (Signal Corps) Stock No.	Mfr. and Mfrs. Designation	Contractors drawing and Part No	Standard Navy Stock No.	All Symbol Desig-Involved
MS-102	Cement: w/catalyst in 1.4 pt can	Cements meter window glass to panel			Mina Mining 3-M EC-801	Kelley-Koett part/dwg #A-6148	N52-C-1148-755	MS-102
XV-101	Socket, Electron Tube	Socket for V-103	JAN type TSE7T101	228677.94	Eby #9064	Kelley-Koett part/dwg #AA-4813-1	N16-S-62603-6900	XV-101
XV-102	Same as XV-101	Socket for V-104						XV-102
XZ-101	Socket, Electron Tube: 11 contacts; octal style; mts in 1-5/32" chassis hole, 2 mtg holes 0.156" diam on 1-1/2" centers	Socket for Z-101		228681.17	Amphenol #77-MIP-11	Kelley-Koett part/dwg #IDA-4814	N16-H-73136-4125	XV-101 XZ-101

TABLE 8-3. MAINTENANCE PARTS KIT

Key Designation	Signal Corps		Chemical Corps		Navy		Air Force	
	Box No.	Quantity	Box No.	Quantity	Box No.	Quantity	Box No.	Quantity
C-101					1	2		
C-102					1	1		
C-103					1	1	1	1
C-104					1	1	1	1
E-105	1	1	1	1	1	1	1	1
H-103					1	2	1	1
H-202							1	1
H-204					1	1		
N-101							1	1
O-112							1	1
O-118					1	2		
O-201							1	1
O-206							1	1
P-101					1	1		
R-104					1	1	1	1
R-106					1	1	1	1
R-110					1	1	1	1
S-101A					1	1		
S-101B					1	1		
S-101C					1	1		
V-101	1	1	1	1				
V-102	1	1	1	1				
V-103	1	1	1	1				
V-104	1	1	1	1				
W-201					1	1	1	1
Z-101	1	1	1	1	1	2	1	1
CR-101					1	1		
MS-101					1	1		
MS-102					1	1		

TABLE 8-4. LIST OF MANUFACTURERS

ABBREVIATIONS	NAME	ADDRESS
Aerovox	Aerovox Corp.	New Bedford, Mass.
Alden	Alden Products Co.	Brocton, Mass.
A-B	Allen- Co.	Milwaukee 4, Wis.
	Allen Mfg. Co.	Hartford 1, Conn.
Amphenol	American Phenolic Corp.	Chicago, Ill.
Amperex	Amperex Electronics Products	Brooklyn, N.
Boston Gear	Boston Gear Works inc.	North Quincy, Mass.
Bradley Lab	Bradley Laboratories Inc.	New Haven, Conn.
Central Lab	Centralab Div. Globe Union, Inc.	Milwaukee, Wisc.
Cinch	Cinch Mfg. Corp.	Chicago, Ill.
Dubilier	Cornell-Dubilier	S. Plainfield, N.
Eby	Electric Corp. Eby, Hugh H. Inc.	Philadelphia, Pa.
Erie	Erie Resistor Corp.	Erie, Pa.
GE	General Elec. Co.	Schenectady, N. Y.
.....	Industrial Products Co.	Danbury, Conn.
-----	! Kords, Inc.	Hamden, Conn.
Mallory	.ory, P. R. Inc.	Indianapolis, Ind.
Micamold	.Micamold Radio Corp.	Brooklyn, N. Y.
Millen	Millen, James, Mfg. Co.	Malden, Mass.
Minn Mining	Minnesota Mining & Mfg. Co.	St. Paul, Minn.
Natl Carbon	National Carbon Co.	Cleveland, Ohio
Oak	Oak Mfg. Co.	Chicago, Ill.
-----	Precision Rubber Products Corp. rp.	Dayton, Ohio
	Raytheon Corp.	Waltham, Mass.
RCA	Radio Corporation of America	New York, N. Y.
-----	Rogan Brothers	Chicago, Ill.
Sprague	Sprague Electric Co.	North Adams, Mass.
-----	The Staver Co. Inc.	Brooklyn, N. Y.
Wemco	Westinghouse Electric and Mfg. Co.	East Pittsburgh, Pa.

TABLE 8-5. APPLICABLE COLOR CODES

CAPACITOR COLOR CODES

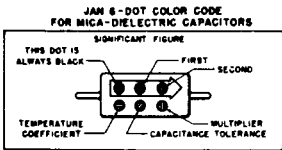
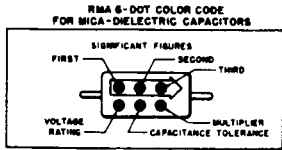
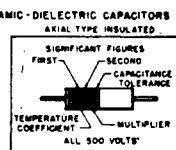
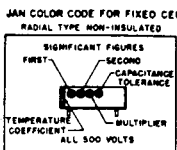
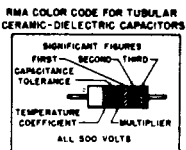
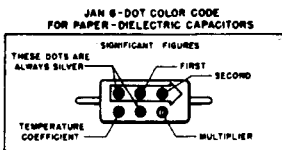
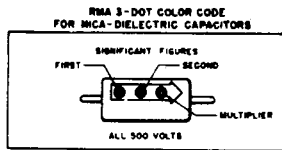

RESISTOR COLOR CODES

RMA COLOR CODE FOR FIXED COMPOSITION RESISTORS

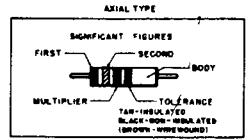

JAN COLOR CODE FOR FIXED COMPOSITION RESISTORS

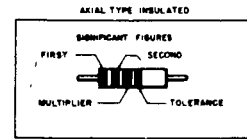

RADIAL OR AXIAL TYPE

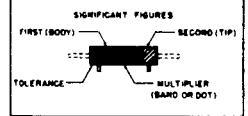

RADIAL TYPE NON-INSULATED

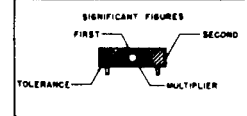

RMA RADIO MANUFACTURERS ASSOCIATION JAN JOINT ARMY-NAVY

CAPACITORS				RESISTORS			
VOLTAGE RATING	TEMPERATURE COEFFICIENT	MULTIPLIER		SIGNIFICANT FIGURE	COLOR	TOLERANCE	MULTIPLIER
		RMA MICA AND CERAMIC-DIELECTRIC	JAN MICA AND PAPER-DIELECTRIC				
100	B	10	10	10	0	BLACK	1
200	C	100	100	100	1	BROWN	10
300	D	1,000	1,000	1,000	2	RED	100
400	E	10,000	1,000	1,000	3	ORANGE	1,000
500	F	100,000			4	YELLOW	10,000
600	G	1,000,000			5	GREEN	100,000
700	H	10,000,000			6	BLUE	1,000,000
800		100,000,000			7	VIOLET	10,000,000
900		1,000,000,000			8	GRAY	100,000,000
1,000		1,000,000,000		0.01	9	WHITE	1,000,000,000
2,000		0.1	0.1			GOLD	5 0.1
3,000		0.01	0.01			SILVER	10 0.01
						NO COLOR	20

This fine document...

Was brought to you by me:



[Liberated Manuals -- free army and government manuals](#)

Why do I do it? I am tired of sleazy CD-ROM sellers, who take publicly available information, slap “watermarks” and other junk on it, and sell it. Those masters of search engine manipulation make sure that their sites that sell free information, come up first in search engines. They did not create it... They did not even scan it... Why should they get your money? Why are not letting you give those free manuals to your friends?

I am setting this document FREE. This document was made by the US Government and is NOT protected by Copyright. Feel free to share, republish, sell and so on.

I am not asking you for donations, fees or handouts. If you can, please provide a link to liberatedmanuals.com, so that free manuals come up first in search engines:

<A HREF=<http://www.liberatedmanuals.com/>>Free Military and Government Manuals

– Sincerely
Igor Chudov
<http://igor.chudov.com/>