

# 74 !

THE KNIGHTS QRSS WINTER  
2019 COMPENDIUM 2<sup>nd</sup> edition



The great  
creativity  
explosion  
of 2019

- KNIGHTLY NEWS
- 28MHZ REPORT
- GRABBING THE GRABBERS
- BEHIND THE GRABBER
- SPOTLIGHT ON THE KNIGHT
- TECH NOTES
- WATCHING THE IONOSPHERE
- AND MORE !



# *Knighly News*

So here we are at the end of 2019, winter time for us in the northern hemisphere, and summer for upside down people, and here is the Knights QRSS second yearbook, or scrapbook as it might be better known. 2019 is an interesting year. In the history of radio communication, we are experiencing the worse ever solar cycle. Many grabbers are looking blank. But not all the time. Propagation is there if you look for it. We need to remember that we are not here to DX in the traditional sense. We are here to observe and characterise the ionosphere. If our grabbers look blank then they are doing their job. They are telling us that there's no propagation, or that it is poor. Being able to DX should really be a secondary consideration.

Now let us be honest here. I would estimate that for the next 3 years, propagation will be bad. We have about 3 years of bad times. But will they really be bad ? Not if the Knights of the QRSS have anything to do with it. The Knights have already proven that they can beat all the odds. Let us look at how the Knights of the QRSS did it. By *CREATIVITY* and determination.

Let us start with "Super Dave" WA5DJJ. Dave has continued to improve his Super Grabber system to cover as many HF band as possible. Additions have included the 22m HiFer band and the 630m band. Dave continues to make use of the QRP Labs QCX series of transceivers and Raspberry Pi 3's as decoders using QRSSPIG software by HB9FXX. Dave has also continued on his mission to put as many stations on the air in the W5 land as possible, with great success !



## **KIWI GRABBERS**

Another success of the Knights of the QRSS is the utilisation of the network of internet based receivers called the Kiwi network.

Notable operators such as W4HBK, M0GBZ and G0FTD have been providing what are referred to as virtual grabbers for the QRSS community during the year.

These grabbers complement normal "real" home based grabber stations. They can provide grabber systems that would not normally exist to unusual parts of the world. It must be remembered that QRSS as well as modes such as WSPR appear to be a 1<sup>st</sup> World mode. Apart from Europe, North America and Oceania there appears to be very little activity from anywhere else in the world.

Meanwhile Henry W6REK was busy sending the first TV Testcard on QRSS. Maybe a world first ? Henry's first creative outburst is seen here, as the classic American **Indian Head** style card, modified for for QRSS.

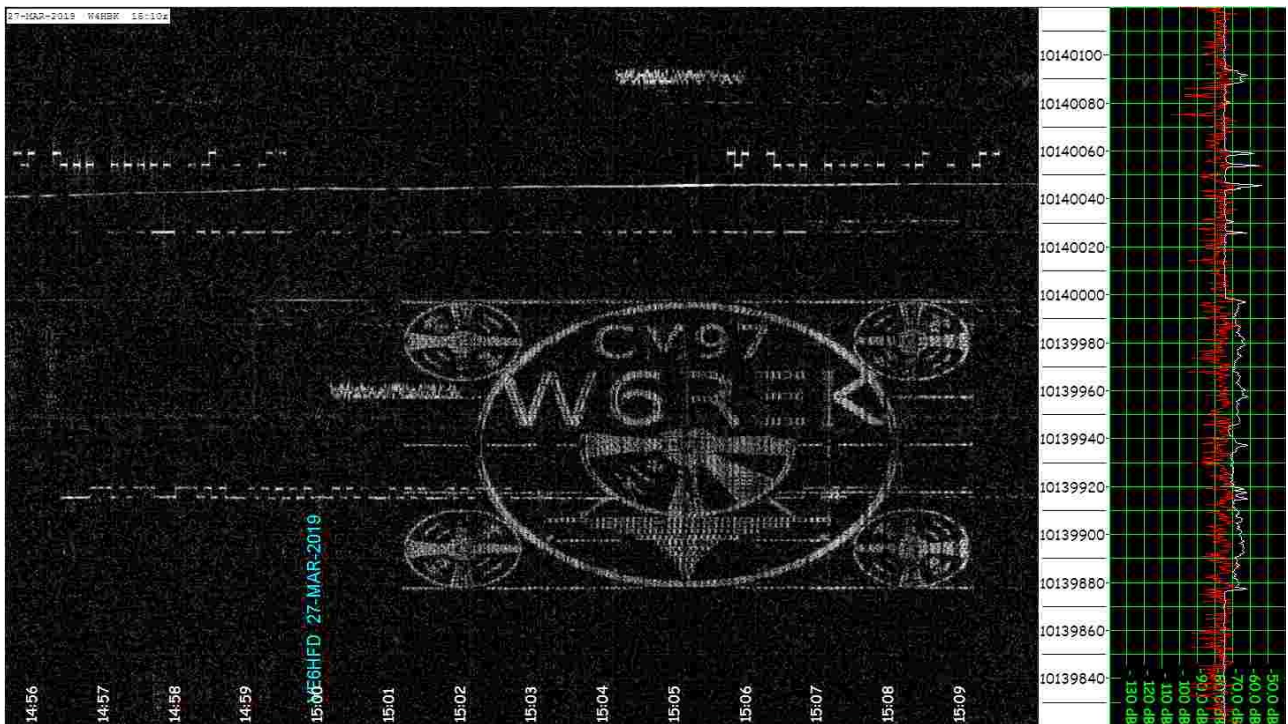

Henry's next creative output was to send his call sign and locator using a graphic that emulated Baudot code on old style punched paper tape.

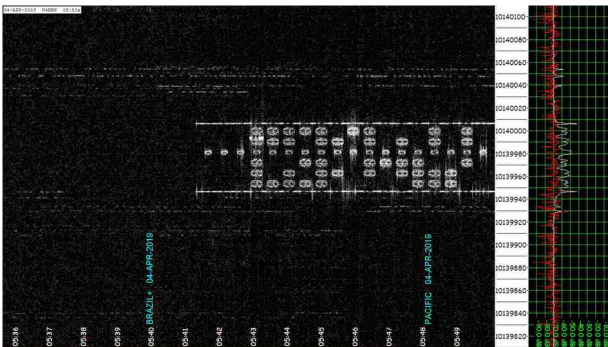

Punched paper type (left) and the Baudot code table (bottom).

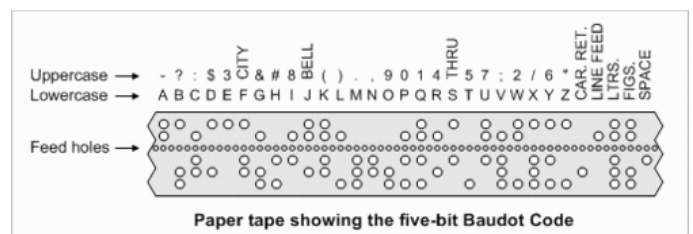

I also learnt from W6REK's experiment that there were quite a few standards when it came to punched paper tape coding schemes ! Continuing on the theme of creativity, the use of adding 24 hour movies to individual grabber sites is being seen. These provide an excellent way catch up on events for busy grabber watchers. To date, this seems to be performed easiest with using Linux based systems. The use of Raspberry Pi single board computers is increasing too for grabber operators. It sure saves tying up an expensive and energy guzzling desktop PC for only about £40 (or \$50). Scott AJ4VD is back in action these days following some brave medical treatment. But he has bounced back more enthusiastic than ever. He has recently improved his famous QRSS Plus website to include options for faster loading of the web pages on slow connections and mobile devices, as well as updating the image stacking feature.



In a slight variation to the normal QRSS signals, Radovan OK1FCX has been using one of his grabbers to monitor the OK0EU beacon network on 80m. There are 5 QRP beacons, all spaced at 4Hz apart. They run 1 watt output to a low dipole antenna. The idea is to monitor for Doppler effects in the ionosphere. Since the ionosphere is constantly moving and changing, there will be a slight variation in the speed of the received radio signal. This changes the frequency of the signal very slightly. Under normal conditions this is usually no more than 1Hz. The same work carried out by others in the past confirms this. *If there was no ionospheric movement then the traces on each TX would be straight lines.*

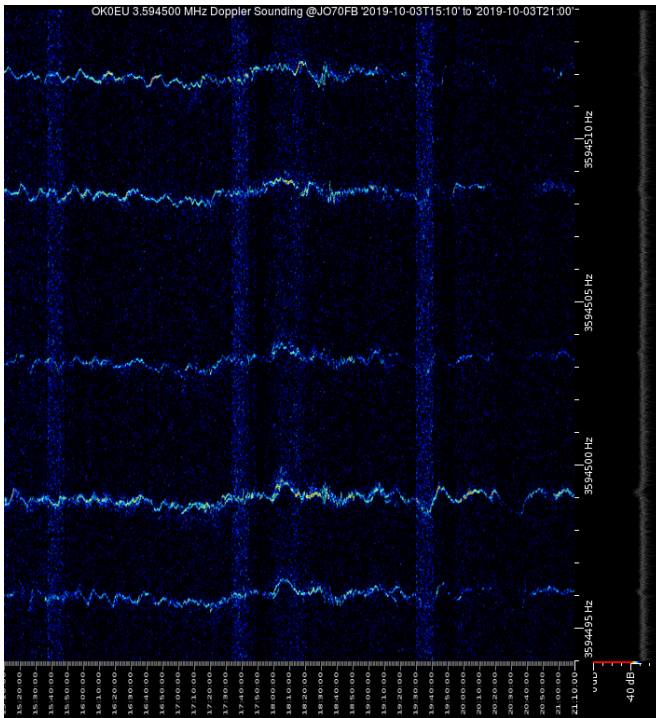

The five traces on OK1FCX's grab are -

- 3 594.492 kHz Vackov (JO60EF)
- 3 594.496 kHz Dlouhá Louka (JO60TP)
- 3 594.500 kHz Panská Ves (JO70GM)
- 3 594.504 kHz Průhonice (JN79GX)
- 3 594.508 kHz Kašperské Hory (JN69SD)

OTHERS (Not on the grab) -

- 7 038.496 kHz Dlouhá Louka (JO60TP)
- 7 038.500 kHz Panská Ves (JO70GM)
- 7 038.504 kHz Průhonice (JN79GX)

Stability:  $2 \cdot 10^{-10}$

Output power: 30 dBm (1 W)

Website: <http://ok0eu.fud.cz/>

Website: <http://ok1dub.cz/ok0eu/>

Website: <http://datacenter.ufa.cas.cz/>

Radovan also had a fishy theme to his 80m transmissions during the Winter/Spring period when propagation was good. Here we see what looks like a punk tuna swimming about. At the same time Ringo Starr was spotted in his yellow submarine too.

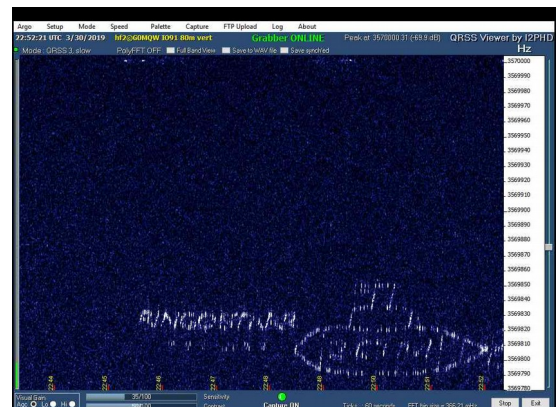
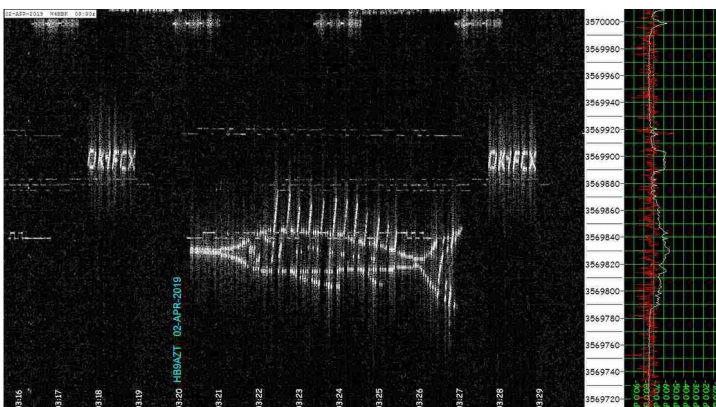

That must have been quite a wild party down there on the 80m sea bed. **Ringo and the Punk Tuna's** has a certain ring to it. Great name for a rock and roll band. But I guess Elvis was too busy to make it to the gig ? It must be remembered that all of this is generated by a simple Raspberry Pi and a small amplifier added to a GPIB port. There is NO external SSB rig or similar etc. W6REK and OK1FCX really gave a lot of fun back in 2019 with their unique creativity.



Paul, M0BMN back in April conducted a useful power output test, and compared 2.5 watts output to a mere 50 milliwatts output. The results were very interesting. They show that while all power increase is good. But excellent results can be had with tiny output powers. This test was purely random. Just a random day, random propagation (nothing special happening) and that was it !

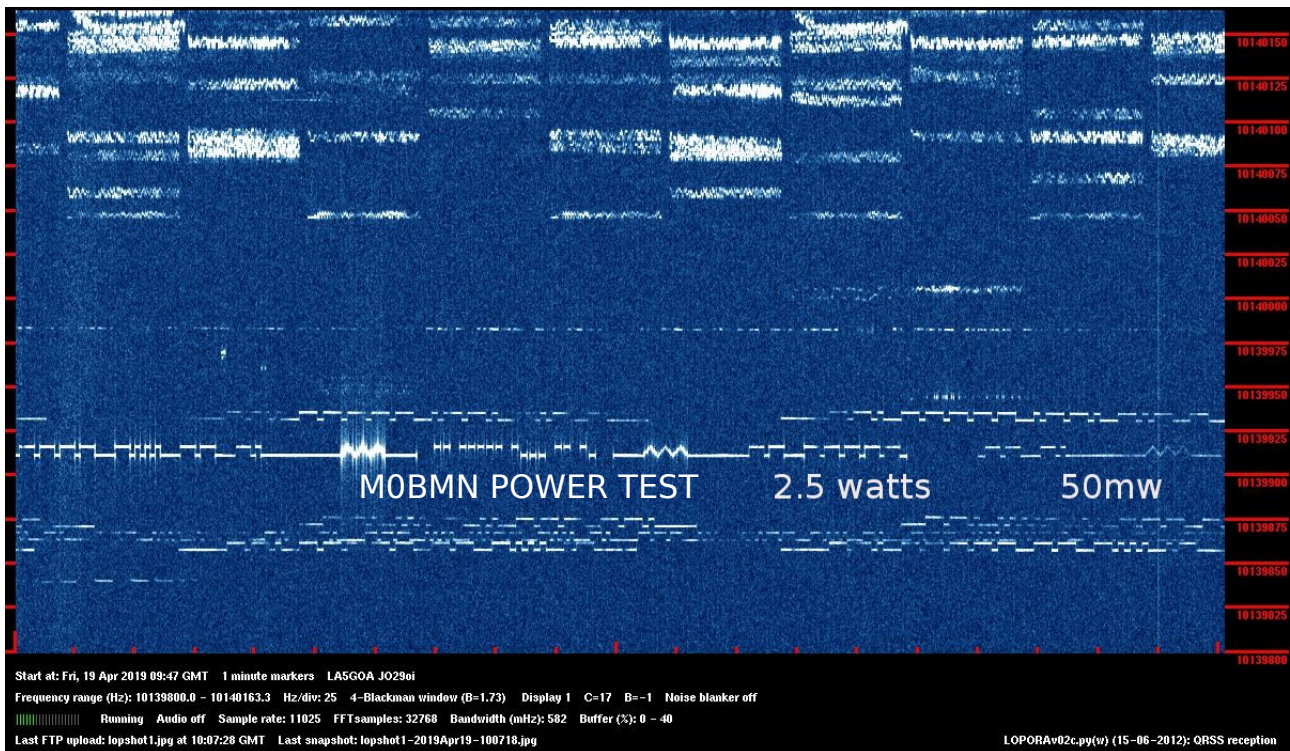

Indeed Paul M0BMN has been a busy man this year. During a period of having no antenna available to him, he decided to tune up a pair of STEP LADDERS for an antenna. He even managed to reach the USA with them ! Yet another 2019 example of QRSS operator creativity.



It looks like Dave WA5DJJ has done it again. This time with the worlds first 6m QRSS grabber. Using an RTL SDR dongle, simple vertical and a Raspberry Pi for the grabber. Who will be next ?

Dave is also doing a great job with QRSS by building and providing QRSS rigs for the locals. And it's working. He is making converts as well as making activity. A real success story.

Over now to PA2OHH, Onno from his QTH in Spain. Onno is experimenting with building a "mini" super grabber, a bit like WA5DJJ. Maybe with 3 bands. So 2019 could prove interesting with more grabbers than ever on the scene.



# The 28Mhz Report

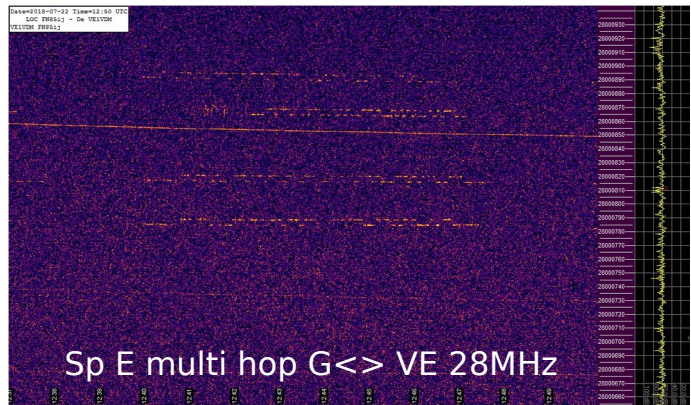

Now here's a strange thing. We are at the minimum of the sunspot cycle. We are at the minimum of the **worst** sunspot cycle known to radio amateurs ever ! And what happens ? The best ever amount of 10m activity for QRSS ever known (to date). Amazingly, there was probably a 100% increase in stations active, and more DXCC countries in the air than ever before.

As expected at this time of the solar cycle, there was no F2 layer activity to report. All known activity was by Sporadic E or Meteor Scatter. There was a noticeable lack of multi hop sporadic E reports via WSPR and QRSS. In the past, northern hemisphere summertime should result in some excellent multi hop Sporadic E, often extending into the west coast of the USA from Europe and sometimes into northern South America. Under such conditions it is even possible to receive Band 2 FM broadcasts (circa 100Mhz) from Canada into the UK and Ireland. But this year....nothing. This totally corresponds to work conducted by SWL Ron Ham, and often reported in UK magazines such as the RSGB's Radcom or Practical Wireless a few decades ago. Sporadic E is almost a constant regardless of solar cycle, EXCEPT at the very bottom of it, where this is a slight reduction. At the top of this page, you can see a grab from Vern, VE1VDM who so far has been the only person to catch multi hop sporadic E QRSS signal from southern England to Canada back in 2018.

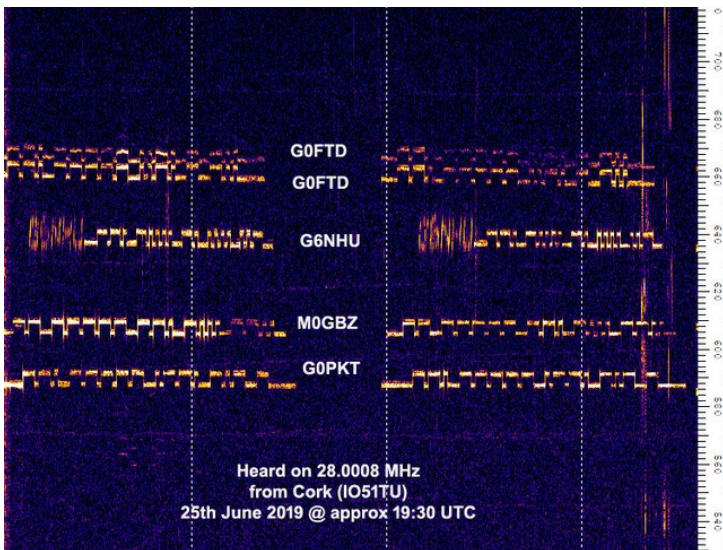

John EI7GL made some excellent contributions during 2019 for the 28Mhz band. On the left here we can see some short skip Sporadic E from south east England to Ireland. (See left). The two traces of G0FTD were of two transmitters. One was feeding a bedroom wire loop, that was around a picture rail. The other was a quarter wave ground plane in the loft (roof space). Not a lot of difference really. Amazing to think that average TX power was only 500 milliwatts, all stations.

Another view from John EI7GL on the 19<sup>th</sup> of June 2019 shows more stations as well as G0FTD's secondary transmitter at a lower frequency. The lower frequency TX was running 10x less power and to an indoor wire loop. The loop was hidden near the picture rail, horizontally, size more suited for 17m band. See the 28Mhz Grab Gallery.



# THE 28MHZ GRAB GALLERY

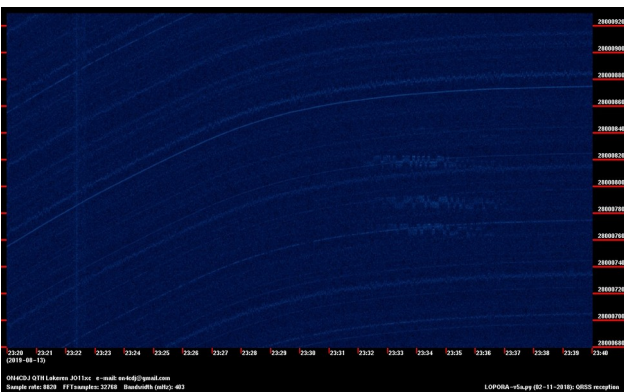
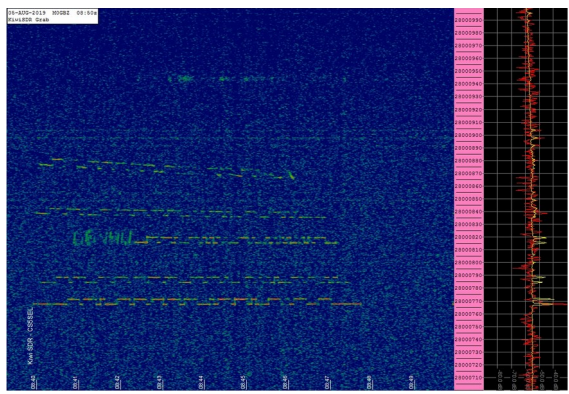
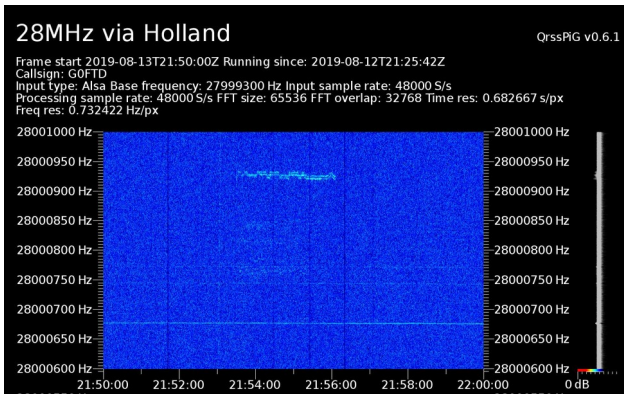
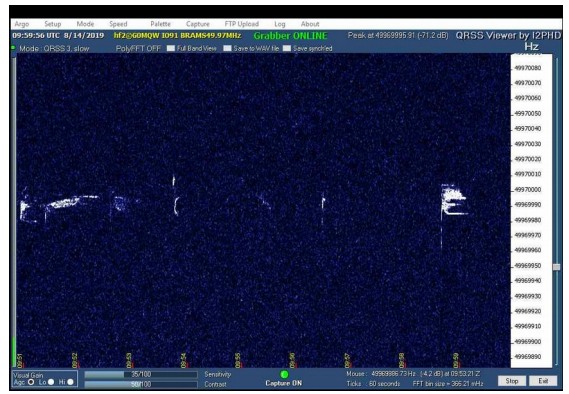
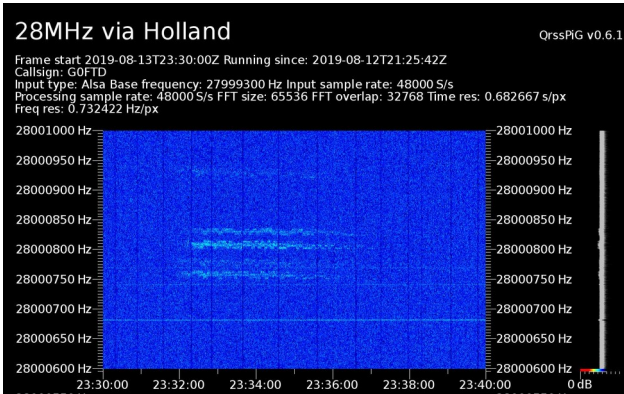
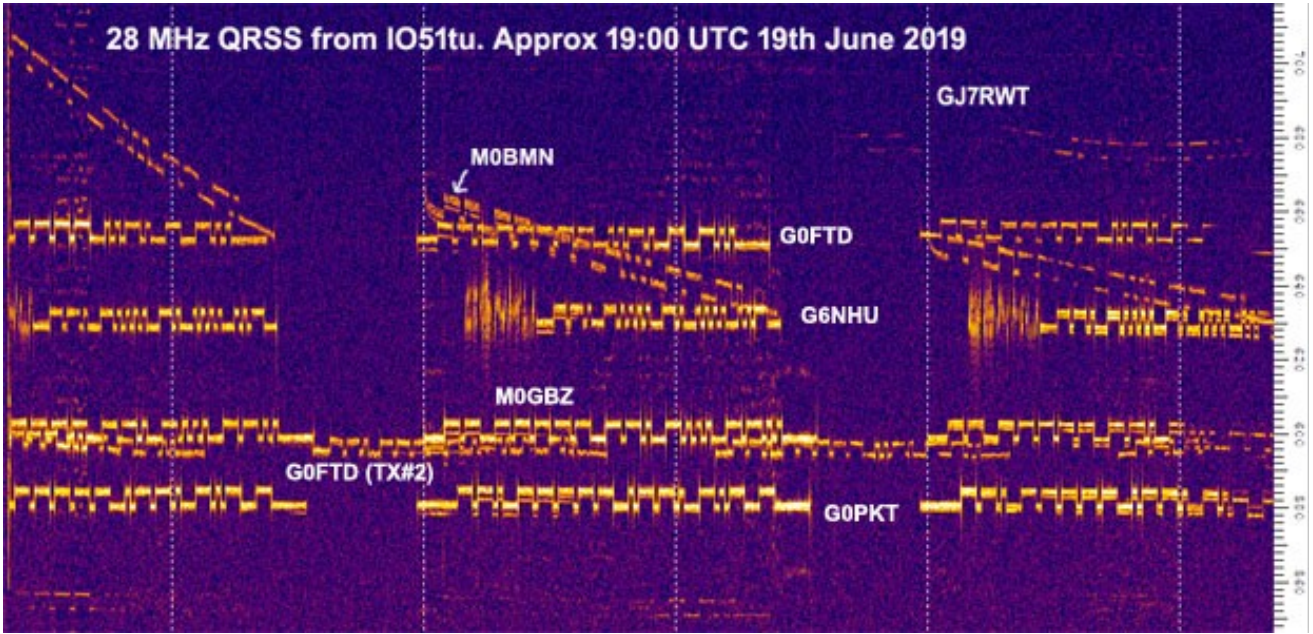

B C

D E

F

- A:** EI7GL in Cork Ireland Sp.E mode
- B:** UK via Holland (Perseids)
- C:** DL0IGI via G0MQW (Perseids)
- D:** UK via Holland (Perseids)
- E:** UK via Portugal (M0GBZ/Kiwi Sp.E)
- F:** UK via ON4CDJ Belgium (Perseids)
- G:** UK via Kiwi RX Europe. (Sp.E)
- H:** UK via Portugal
- J:** G0PKT, G0FTD, DF1ENZ. via G4IOG.
- K:** UK via SA6BSS Sp.E mode



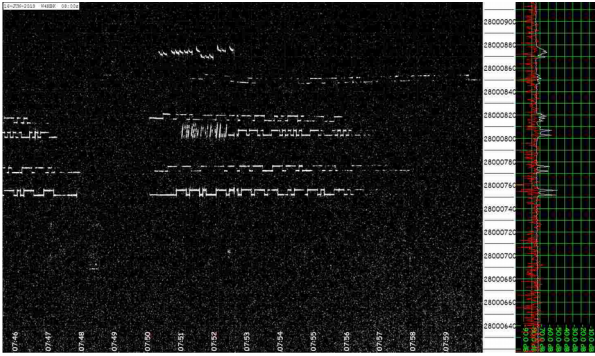

G H

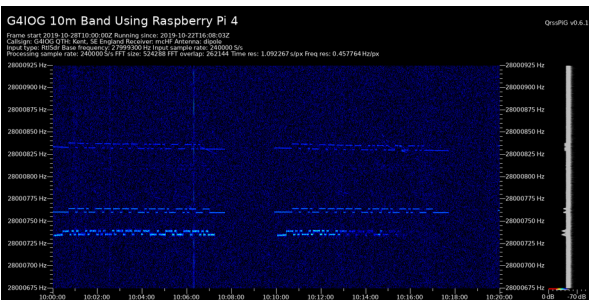
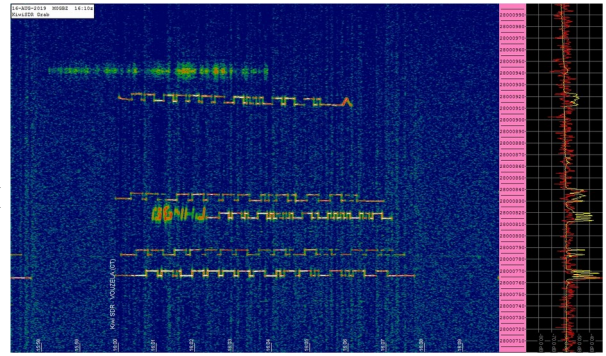

J K

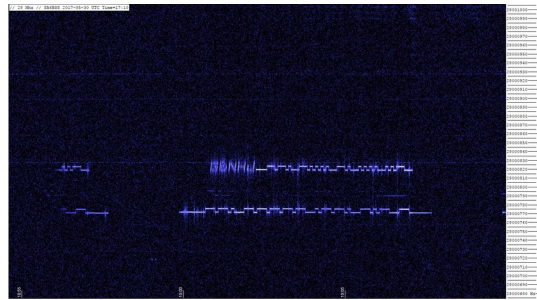

As you can see, there is life on the 10m band but you have to catch the right time. It's no good putting in a few hours and expecting the world at your feet. It sometimes takes months of patience. Radovan OK1FCX has been active on 10m with a simple vertical antenna and a 10 milliwatt transmitter, a water cooled Raspberry Pi. The most crazy thing is that there were times when Radovan was the ONLY signal seen on UK grabbers, despite being the lowest power station on the band.

And the big disappointment..

In November the Monocerotids, a very rare meteor shower was billed as being available with potentially a ZHR of 1000. Normally we see typical ZHR's of 50 for other showers.

There was even a precision time for it. 22<sup>nd</sup> November 2019 at 0450 UTC was predicted. QRSS grabbers were active and spotted the event, but the peak was very small. And 5 minutes early. No good signal grabs were obtained unfortunately that were worth publishing. A bit of a disappointment really, despite the big numbers.

Indeed, over the last few years experience has shown that the ZHR numbers are almost meaningless when it comes to QRSS. Great results have been seen with ZHR's of 5.

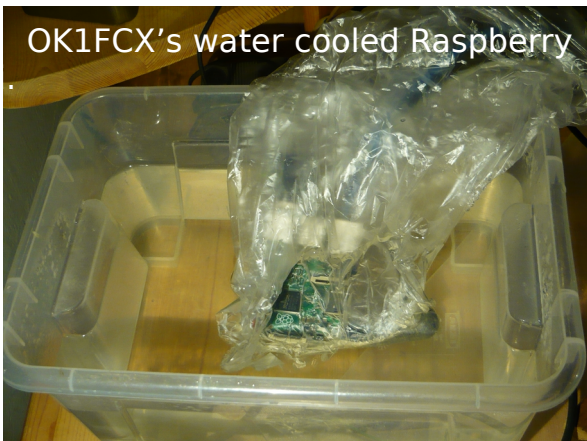
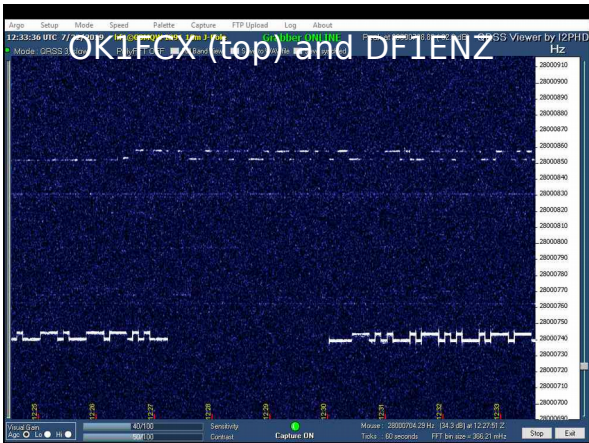





This is because Windows is the odd one out here. All other operating systems use the forward slash to separate path names. For example **C:\grabs\la5goa** on Windows is **home/grabs/la5goa** on every other operating system.

The next step is to automate all of this using a script file. On Windows we could create a .bat file or on Linux a simple shell file, either .bash or .sh and then execute it. I personally like to automate the script for every five minutes and here is an example of my wget script.

```
#!/  
echo "STARTING TO GRAB THE GRABBERS"  
echo " "  
date  
while [ true ]  
do  
    wget -P grabs/aa7us-hf3 http://www.qsl.net/aa7us/hf3.jpg  
    wget -P grabs/ok1fcx http://www.qsl.net/ok1fcx/hf1.jpg  
    wget -P grabs/ok1fcx-2 http://www.qsl.net/ok1fcx/hf2.jpg  
    wget -P grabs/ok1fcx-3 http://www.qsl.net/ok1fcx/hf3.jpg  
    # wget -P grabs/df2jp630m http://www.df2jp.dxx.eu/630m.jpg  
    wget -P grabs/dl4dtl https://qsl.net/dl4dtl/hf2.jpg  
    wget -P grabs/ea8bvp http://www.qsl.net/ea8bvp/hf1.jpg  
  
date  
echo " "  
echo "> NOW WAITING 5 MINUTES BEFORE THE NEXT SET OF GRABS <"  
  
sleep 300  
done
```

These commands are simply saved as a text file. Some versions of Linux for example will allow you to run a .txt file as an executable, or you may wish to save it as a .bash or .sh depending upon OS preferences. In Windows it would become a .bat file. And then you simply run it. Anything with a # is ignored, except the SHEBANG #! a special command for Unix and Linux to indicate that the file is a script. You don't need this on Windows.

Also, there's yet another way for grabbing the grabbers. There's another script that auto downloads my active grabbers list on my QSL.NET website. It then uses this to download every grabber in the list every 5 mins. I personally update the list so you don't have to. It's automatically updating for you.

[https://qsl.net/g/g0ftd/other/qrss-special/simple\\_five\\_minute\\_grabbergrabs\\_using\\_online\\_control\\_list\\_sept\\_2019.bash](https://qsl.net/g/g0ftd/other/qrss-special/simple_five_minute_grabbergrabs_using_online_control_list_sept_2019.bash)

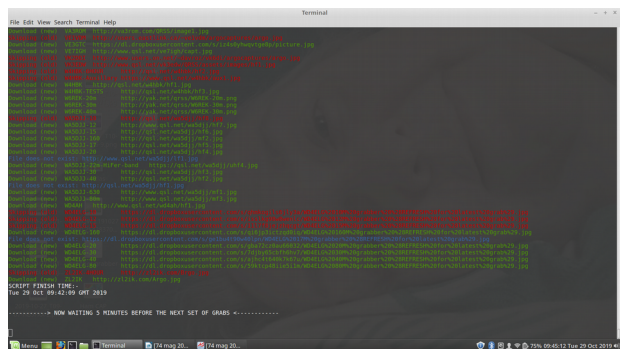
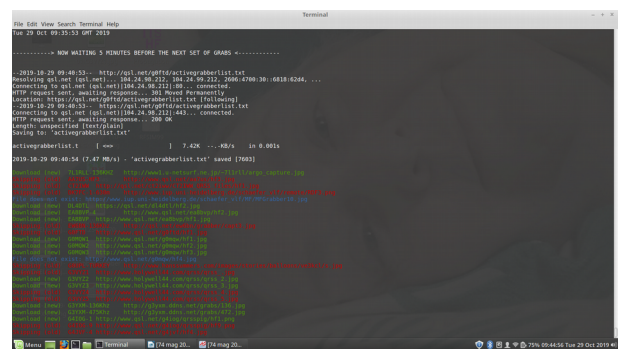



# TECH NOTES

**THERMAL STABILITY.** One of the biggest enemies of QRSS operators is keeping our reference crystal stable. It only takes 0.1° Centigrade of temperature change to make a big difference. One morning I had an email from Bob G4IOG who mentioned that my 28Mhz transmission was acting up. Oh not again I thought. It coincided with the coldest day of the year as we were running up to Christmas. Now then my old QRP LABS Ultimate 2 transmitter is slightly unusual. It's in a custom box, made before QRP Labs even offered boxes. It contains its own PSU and ATU direct to the antenna. It also has a strange but proven method of keeping the air temperature stable in the box, a circulator fan ! It also lives alone in a dark and draughty roof space. Maybe some spiders to keep it company.

The small CPU style fan blows over the top of crystal to disperse air currents from the PA just below it and circulates the enclosed air in the box to keep it as uniform as possible. Unusual, but it works in the way I intended it to be. But when that fan stops working properly the air current system fails. I did wonder if the cold had stiffened up any lubrication, causing the intermittent rotation, but it was just old age of the fan.

BEFORE

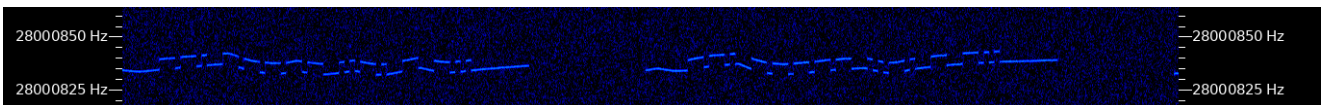

AFTER

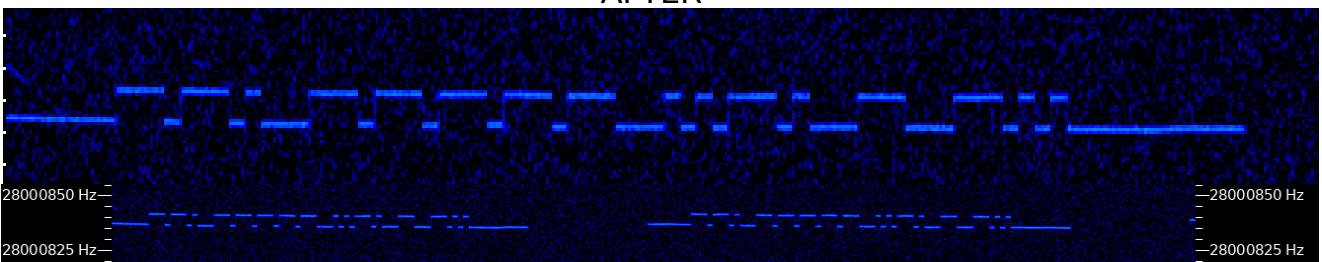

Also this year I made a discovery that also made a HUGE difference, so simple and effective. But I had not discovered it for years. How could I miss such a thing, and what was it ? Well it involved adding some space characters the the start and end of my QRSS signal. The idea is to leave only a small gap (10 seconds) between the WSPR and the QRSS signals. The effect it has on thermal stability, heating up the PA is pretty big. Don't believe me - try it !

Another useful tip comes from Scott AJ4VD. He uses large resistors to make a temperature controlled oven system. You can either bolt them TO the chassis of the TX, or to a piece of aluminium to make an internal heatsink radiator system. I suggest heating power would be about 5 watts in reality. Thermal control sometimes seems to be individual to each rig, so long term experimentation is required.





## SPOTLIGHT ON THE KNIGHT – VK3EDW

I grew up in a dozy country town in Somerset, England called Wincanton.

I discovered interesting sounds and voices on an old radio at home that included two short wave bands - I was hooked at the age of eleven. I got my full Ham Call G4CEB in 1972 and spent far too many hours in my little shack (next to the coal cellar) working the world using a Bendix RA17B aircraft receiver, a valve transmitter and a trapped dipole.

I attended a lecture on reception of weather satellite imagery and yes got hooked on that. After a few months I got my own images, I even published some articles in the RSGB's RADCOM.

After further education in Lancashire I joined the Appleton Laboratory in Slough which started life as the Radio Research Station in 1924 and was the UK government research laboratory which pioneered the regular observation of the ionosphere by ionosonde. In continuous operation from 20 September 1932, it applied the ionosonde technology for the early developments which led to the British Chain Home radar system, operational during World War II. In 1965, it was renamed the Radio and Space Research Station, to reflect its increasing role in space research. In 1974, it became the Appleton Laboratory, in honour of Sir Edward Appleton, who had received the 1947 Nobel prize for his work on the ionosphere and who had long been associated with the station's research, his work hut still existed when I was there. My initial work was the development of a transportable communication container for high altitude balloon experiments in Woomera.

The Appleton Labs moved to the Rutherford Labs in 1979 and became the Rutherford Appleton Laboratories. My work moved to the Ionospheric research side and I established new ionosonde facilities in South Uist in the Outer Hebrides and Slough Berkshire.

During my time at both Labs I was a very active member of the Radio Club G3RRS winning numerous HF contests. In 1982 I was an invited operator at N5AU in the CQ WW SSB contest in which N5AU got No.1 Ranking.

I moved to Australia in 1986 joining a small engineering company that manufactured ionosondes. I established the ionospheric systems division manufacturing high performance HF sub-assemblies and receivers. Much of my work was Defence contract related. I did however install ionosondes and data logging facilities in nine countries.

In 1990 I joined the Jindalee OTHR project as Receive Manager, I became Radar Manager in 1992. I left the JORN project in 1997 and formed my own consulting company. I worked on the Sea Surface Wave Radar deployed for trials on Bathurst Island north of Darwin. I also worked for Saab Aerospace as Project Manager for gantry manufacture and installation on the then developing Melbourne City Link.

When I arrived in Australia I got the call VK3EDW but did little operation until 1994 when I operated through amateur Satellites.

I suffered several heart attacks and strokes 2001 - 2004 then ten years of seizures forcing me to retire. I have always had an interest in low power operation - a keen GQRP club member when in UK. During my first knee replacement I was surfing (as one does in hospital) and discovered QRSS. I made contact with Pete ZL2IK in New Zealand and again the rest is history.

Currently taking care of my daughter, but still a very committed QRSS enthusiast.

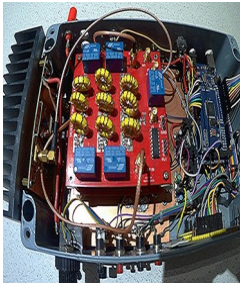

Here's a few pics of John's equipment. As detailed on picture the left, a QRSS TX that uses an Arduino/SI5351/BF180/IRF530 combination. It can set output via the variable Bournes pot from 20mW through to 3W maximum. The band selectable LPF board is my own design and can accommodate up to three filters of up to 7 pole configuration. In the spirit of international friendship, John have a couple of spare boards if anyone is interested - each board is free and a Xmas gift to the first two takers.

LPF PCB

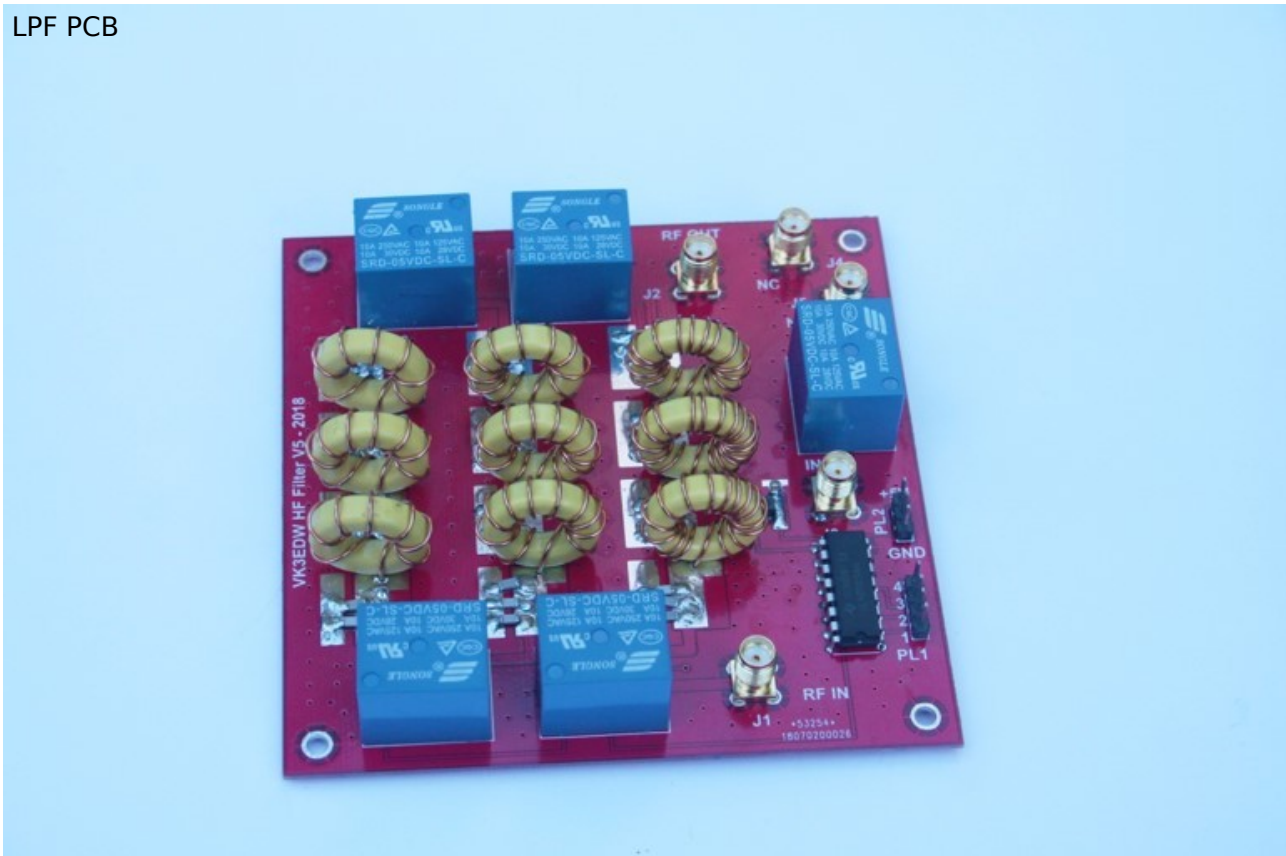

---

## SOME USEFUL WEB RESOURCES

QRSS news, grabber and software repository - <https://qsl.net/g0ftd>

QRSS Grabber Compendium - <http://www.swharden.com/qrss/plus/>

QRSS and stuff - <https://sites.google.com/site/andyg0ftd/test-page>

Animated QRSS Compendium - <http://yak.net:7899/index0.html>

---



# A RANDOM VIEW OF 40M PROPAGATION - 40FTD..

During the Autumn equinox of 2019, I was looking for an experiment to keep me amused. I decided to take advantage of the 24 hour grabs that G3VYZ provides on 40m, and just for fun, test out some daily variations, just to see what happens. I picked three transmitters to review. An Italian CW only beacon, approx 1200 mile away from the receiver, myself at 200 miles, and S52AS at 1200 miles. The first grabs is a reference grab to identify stations easier. Maybe a a month by month test next time. 73/4 de Andy

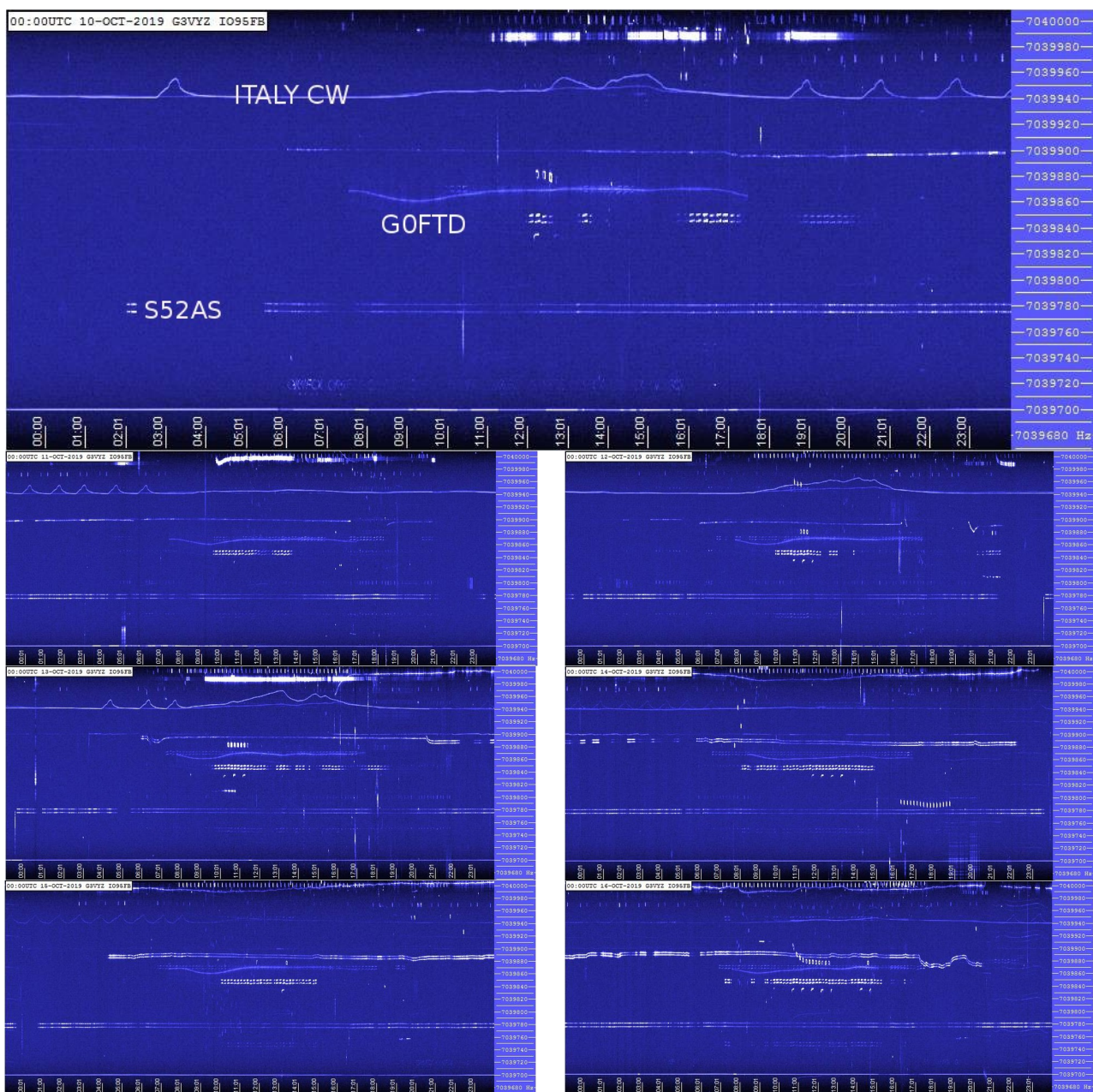



# Behind the grabber...

Now we travel to south east England, on the edge of the River Thames to have a look at Bob G4IOG's three band grabber station.

On the left is the Raspberry Pi 4 which is running 10m and 40m grabbers. It has the keyboard and screen and mouse and 2 SDR dongles. The dongles are attached to the USB expansion unit. The silver one is currently on 40m and the blue one is for 10m. They are attached through home-made filters in the boxes standing alone in the other photo. This creates 2 animations showing the day's reception windows just after midnight, and uploads all the files of the 2 bands continuously.

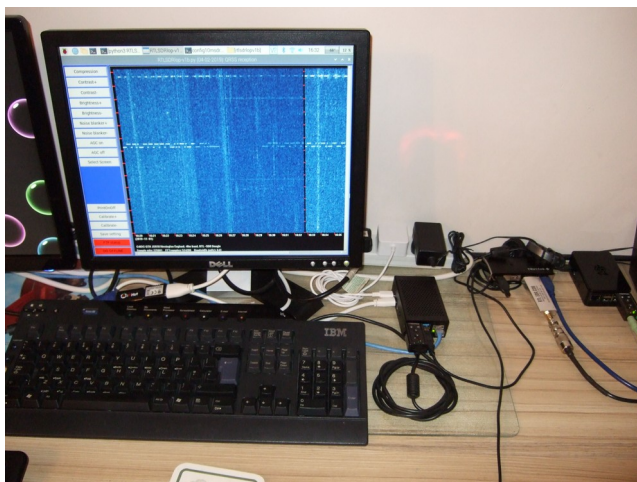

The Raspberry Pi 3B is the one on the right. It is using Audio input for 80m from the mCHF transceiver.

This has no mouse, keyboard or screen. I connect through to it using VNC viewer that comes with the Pi software. This works extremely well for me.

Most of my grabber setup is designed to restart automatically if there is a power cut. We had one this week and it worked like a dream. The only intervention was for me to switch on the mCHF radio to receive the 80m band. Right now I am plagued with terrible QRN and QRM which comes and goes at my home location. Most unfortunately it stays a lot. My antennas are not best situated in my small garden.



FILTER BOXES





# Improving RTL SDR Frequency Stability.



PA2OHH

Onno PA2OHH send us this submission for use in 74 ! this year. Many of us have been testing these cheap dongles that are available for as little as US\$5. The model shown is quite popular too, with a simple HF / VHF antenna splitter and very cheap, about US\$15. I have one myself - de G0FTD. And now over to Onno, aka Mr Feet ;-)

This might be the most simple circuit I ever made, only one resistor! It can be used for any crystal oscillator if you want to improve the temperature drift.

I got such an RTL.SDR and it is really a nice, cheap all band receiver! But when I wanted to use it as a grabber, it needed some temperature stabilization, as the drift was just a little too much. With only one resistor, it was possible to reduce the drift from 18Hz to 5Hz in the temperature range from 10C to 30C and even from 12Hz to 2Hz in the temperature range from 15C to 30C.

## The RTL.SDR. A nice, cheap all band receiver!

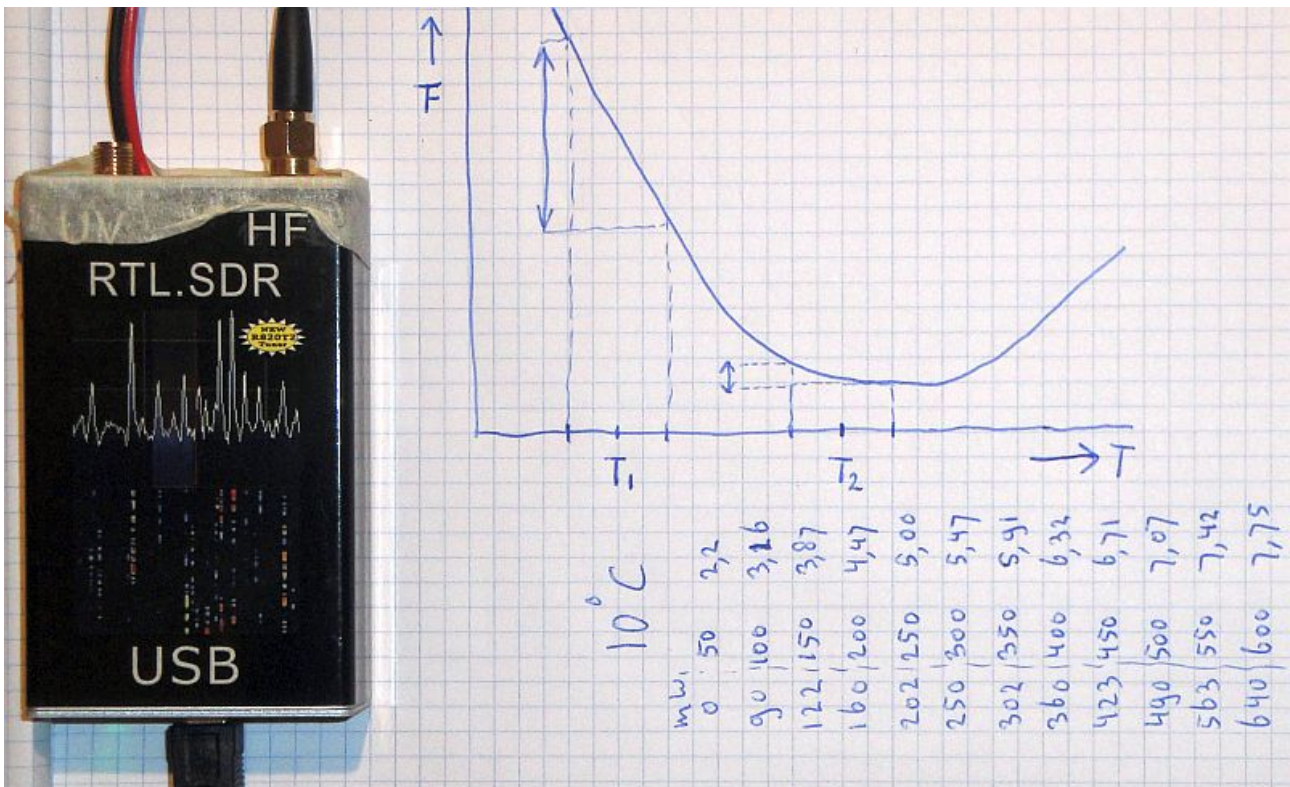

How it works. The crystal is heated by means of a resistor mounted on the crystal. It is heated to the turnover point. Below that point, the frequency of the crystal goes down, above that point the frequency goes up. But around that point the crystal frequency is much less affected by the temperature than at room temperature! So the trick is to heat the crystal that its temperature is at the turnover point during the average room temperature of the RTL.SDR

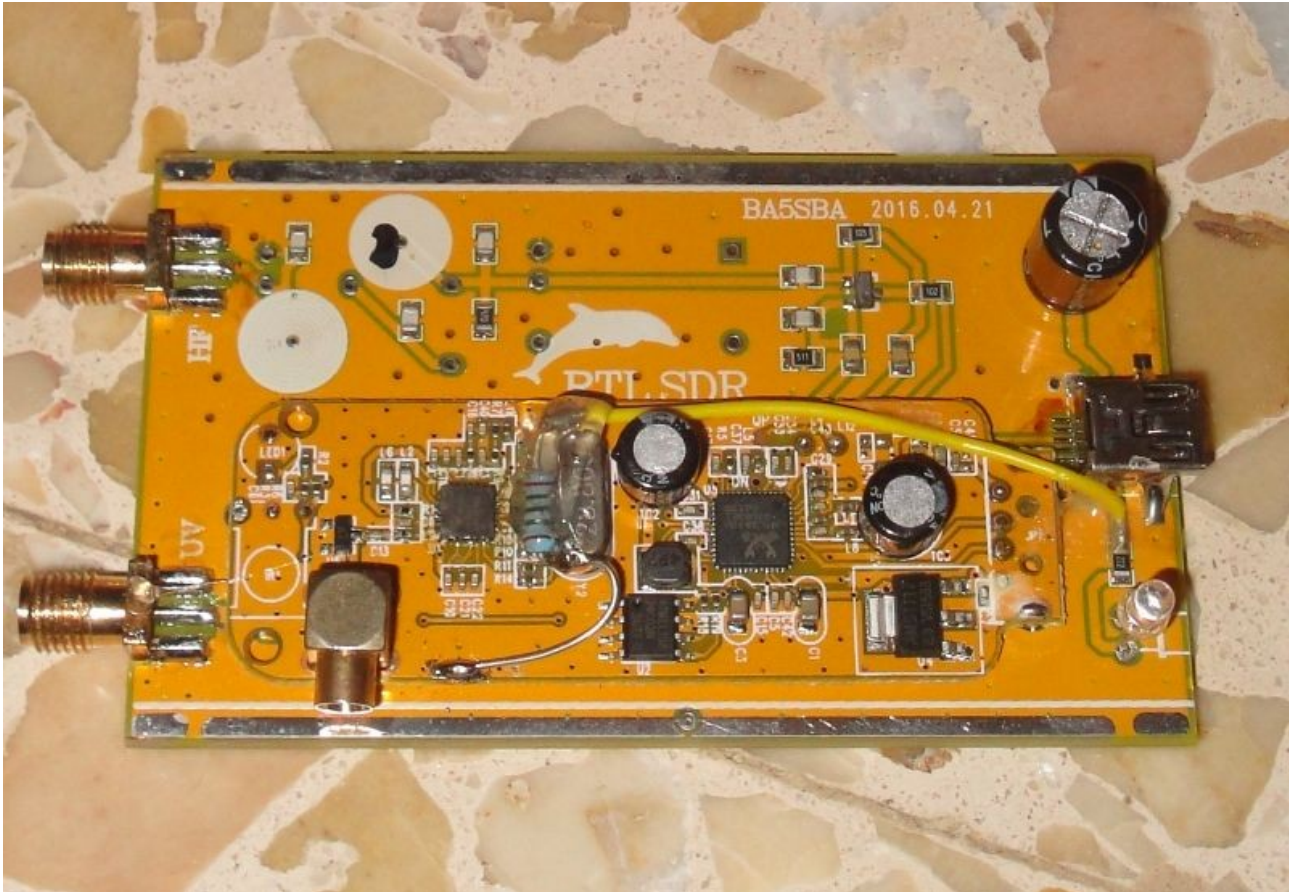

The crystal is heated by means of a resistor. Later, I mounted the resistor on top of the crystal and turned the receiver upside down.

### Results

The drift was reduced from 18Hz to 5Hz in the temperature range from 10C to 30C and even from 12Hz to 2Hz in the temperature range from 15C to 30C. So very acceptable. It was possible to receive many QRSS stations, but the sensitivity of my normal QRSS receiver is approximately 6dB better. .



**How to determine the value of the resistor** I connected a reference frequency of the GPS standard to the RTL.SDR dongle and displayed it on the grabber made with Lopora. When the frequency of the crystal goes up, the graph goes down, as it displays the received tone, that goes just in the opposite direction of the crystal frequency.

The resistor is connected to a variable power supply and the power is increased in steps of 50mW. When I did this test, it was only 10C in my radio lab, so the lowest room temperature instead of the average room temperature. You can see that it reaches its turnover point but that not far above that point, the temperature dependency quickly becomes worse. So avoid to go over that point. When the crystal frequency goes down, the graph goes up. I needed 250mW and that means a resistor of 100 ohm connected to the 5 volt supply of the RTL.SDR

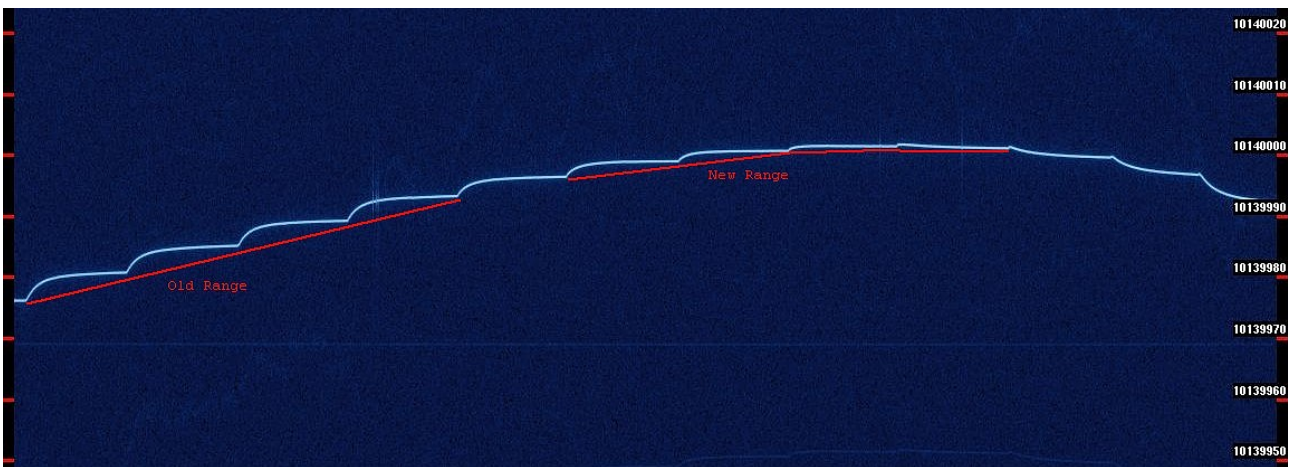

The resistor is connected to a variable power supply and the power is increased in steps of 50mW. One step is approximately 5C. It starts at the left at only 10C that evening.

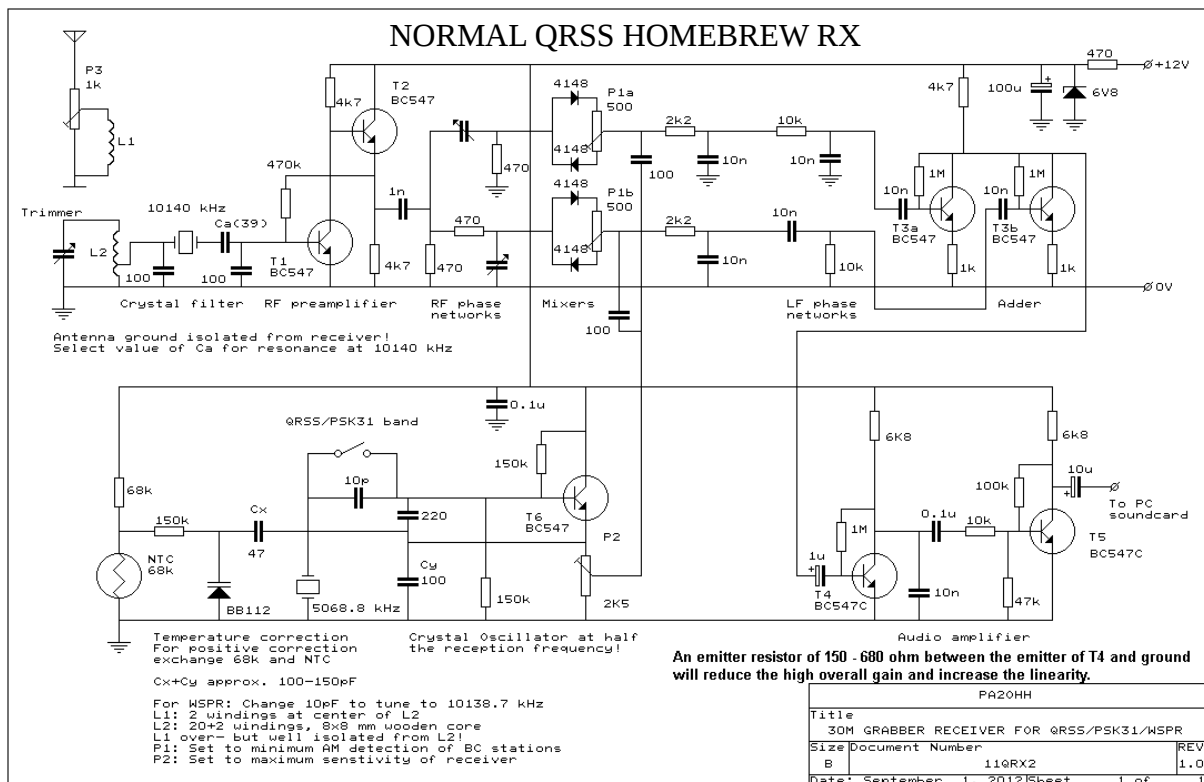

# Candlepower QRSS

---

Proof that QRPP can work even at the bottom of the sunspot cycle.

10 milliwatts or less can work wonders on QRSS, even at the bottom of the sunspot cycle. An the WORST sunspot cycle in living memory too. I was recently surprised to see a new callsign appear on both 40m and 30m on the east coast USA grabbers such as WD4ELG and W4HBK. That callsign turned out to be Bert VE2ZAZ. Bert was using what I call more of a Slow Hell type mode, that is often a lot less efficient than normal QRSS, so it took a little while to obtain the whole message. Eventually I could see that it said VE2ZAZ @RAC.CA, an email address. I emailed Bert who replied -

***`You are the first one to report back on my text QRSS. Thanks for keeping an eye on the grabbers. Output power on 7039 khz is 10 mW, and on 10140 Khz is only about 6 mW! It is the output of an Si5351C synthesizer chip. WD4ELG is the grabber that sees me consistently, and is located 1400 km away. Not bad for 6 mW!`***

***`A 7 MHz half-sloper with feedpoint at the apex, 12 meters off the ground. Daytime I stick to 10140. In the evening and night, I tend to switch to 7039.9`***

***If you are curious about my beacon, see my GitHub page <https://github.com/VE2ZAZ/Si5351-QRSS-Beacon> .`***

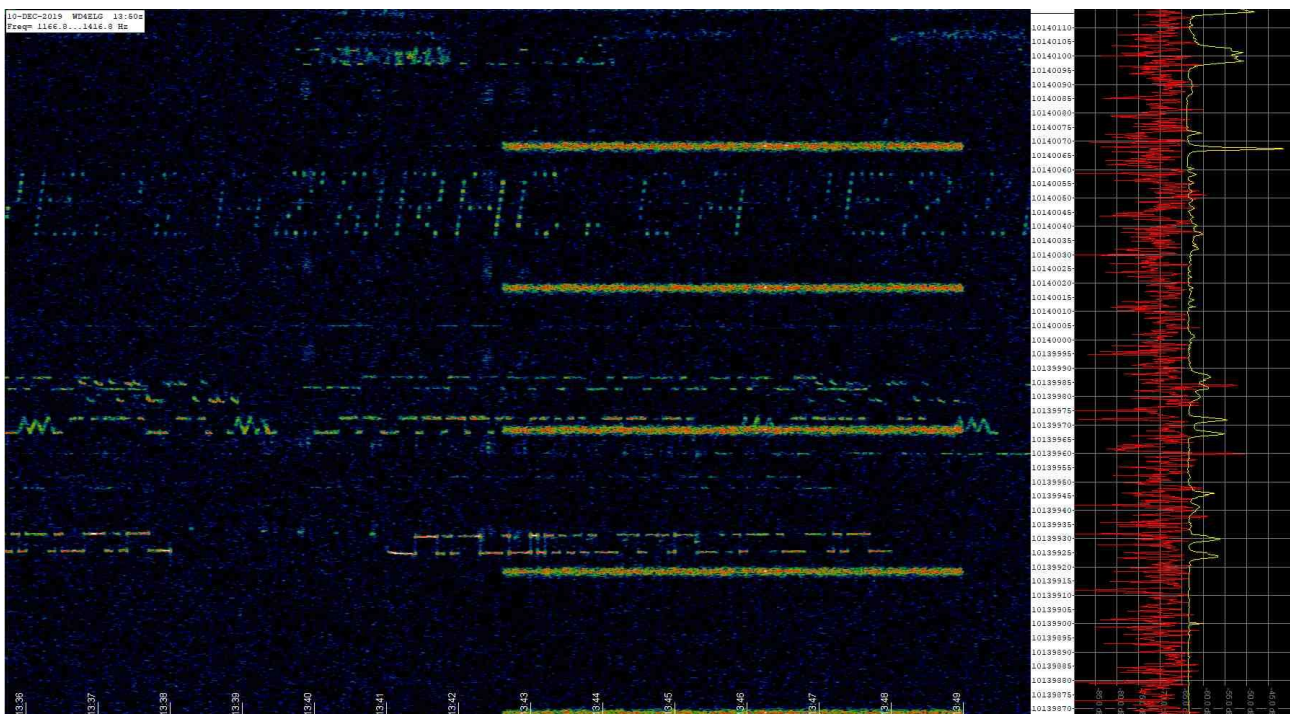

We have also seen good results from OK1FCX and his Raspberry Pi transmitter, approx 10 milliwatts being heard around Europe on 10m with a simple vertical antenna. Well done everyone. QRSS, a truly useful QRPP mode.

---



# Watching the ionosphere in transition.

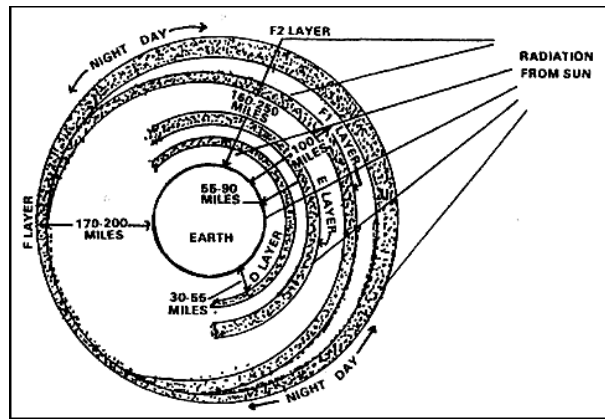

Presented here are a series of observations by OK1FCX and G0FTD. Whilst some of this work will have already been seen through newsgroups, it was felt that it was time to collate the information together for posterity in one place before it gets lost and forgotten. This is the policy of 74!, to record the slow moving events in the world of QRSS instead of being scattered around the internet or lost in our memories.

In FIG 1 we see the start of the day on the 80m band. OK1FCX is the observer of several highly stable transmitters, about 10 miles away in his home country. They normally radiate a steady carrier. But as you can see, the lines are anything but straight due to movement in the ionosphere effecting the frequency. Interesting to note in FIG 1 the start frequency is slightly higher.

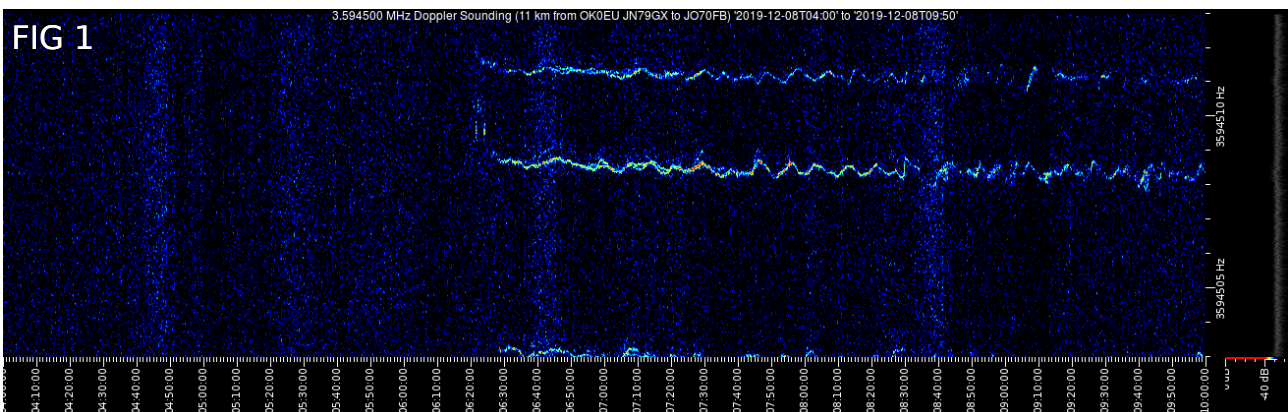

In FIG 2 we see the end of the day when the sun disappears. We start to see at two traces appear. These represent two different paths that the same signal has taken. Presumably these are from the **remainder** of the E layer and the F layer coming together as the sun goes down. Both cases show approx 1Hz shift.

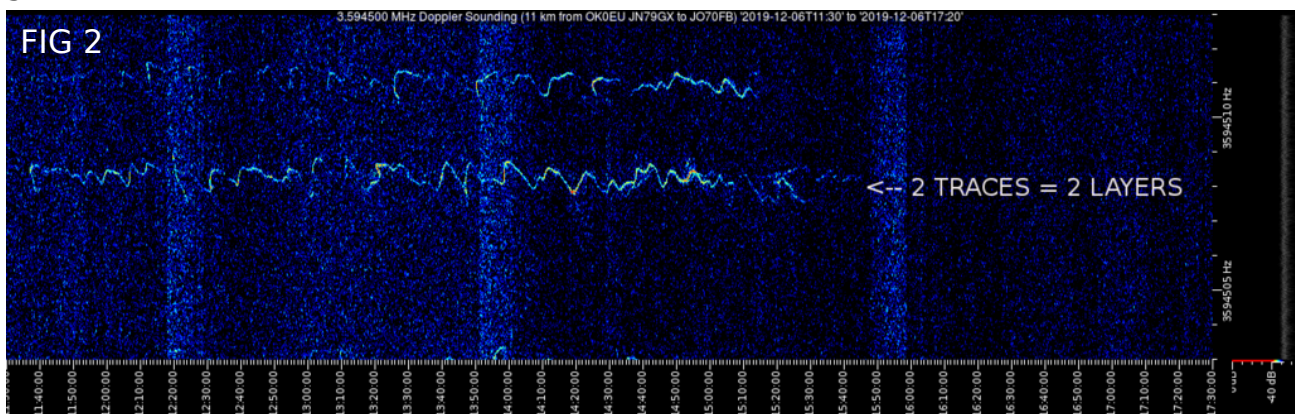



We can also see the two paths at sunset on the grabs below. Here the observer receiver is in Holland about 150 miles away.





Now what about those approx 1Hz oscillations that we see on OK1FCX's 80m grab ? Well Radovan OK1FCX produced the following illustration that I think explains them. During the day, the predominant path is taken roughly at the boundary of what we would call the E layer and the F layer. The slightly different ion density makes the signal wander about, this causing the 1Hz oscillations.

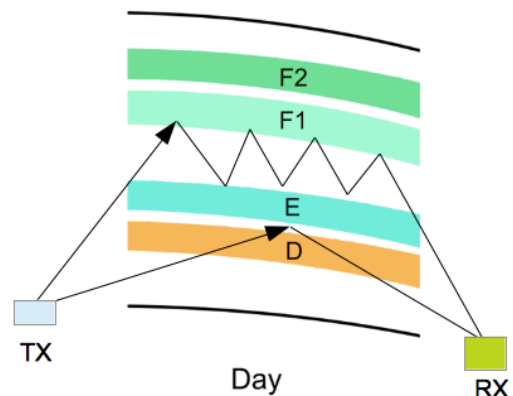

On the same illustration (left) you can also see the typical E and F layer direct paths that can be taken, leading to the times when we see two traces occurring.

Well so far we have described the ionosphere in transition between sunrise and sunset. But what about when the ionosphere is transitioning between no propagation into a state of active propagation ?

Well we can also observe the tell tale signs on other bands too. Below you will see a portion of a grab from G4IOG ON 28Mhz. The clean ground wave signal from G0PKT is used to compare a Sporadic E opening to DF1ENZ.

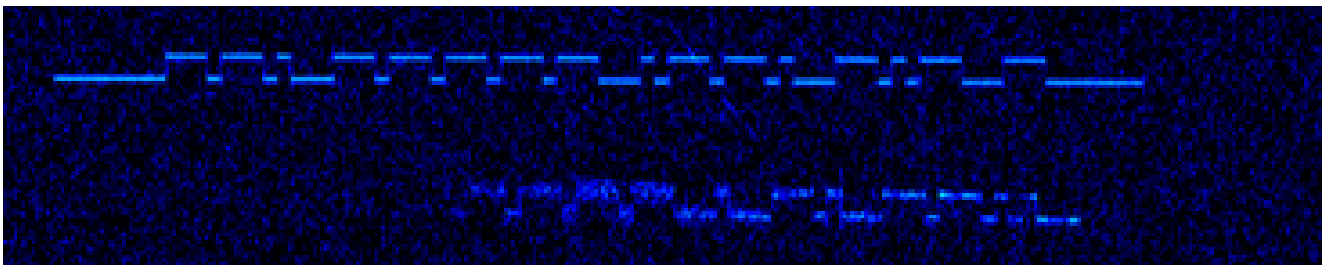

If you look closely, the partial signal from DF1ENZ has a certain fuzziness to it as it starts. This is the tell tale sign of propagation opening and the ionisation is building up. (It can work the other way sometimes at the end of an opening), but it tends to be more of an band opening event. This fuzziness has been observed before on other bands too, including 80m.

Many thanks to OK1FCX and G4IOG for their invaluable input.

~~~~~

If you are not already a member of the Knights QRSS group, please have a look here -

<https://groups.io/g/qrssknights>

~~~~~

# The Tail End



2019's FINAL THOUGHTS FROM G0FTD

One of the characteristics of QRSS is that we DON'T get spoon fed our results. We need to actually do a little work to see them, It takes some effort to collect the results. So we need to help ourselves, and others to become familiar with data collection schemes, such as the methods described in the Grabbing the Grabbers article in this edition. We can all benefit from this. It might be a good idea for us to steer newcomers into these methods before they become disillusioned about the amount of time needed just to see a simple band opening.

Earlier this year I did promise myself to try 50Mhz QRSS. This should be an excellent band in the summertime. Just look at the immense fun that we have had this year on 28Mhz. Regretfully I got as far as building a 6m LPF for my U3S transmitter, and that was it. I was still too busy with Knights projects, such as the YAPI OS image for the Raspberry Pi, providing experimental Kiwi RX virtual grabbers and building group databases. Maybe next year. But there is still one major problem for 6m, and that is grabber receivers. Finding one is the next problem.

With the decline in solar activity, there has been a slight refocus on the LF bands, especially once the summertime Sporadic E season finishes, and 10m fun stops. But don't write off the lower bands in the summer. In 2019, W4HBK suggested a little mid summer madness and we tried 80m. Transatlantic signals were received fairly well. Food for thought.

New data modes such as FT4/8 are becoming a bit problematical as they often cause QRM to our usual operating segments just below the WSPR sub bands. Hopefully the craze will eventually pass, but it does highlight that the area that we operate is always going to be open to the latest data mode fad. The old style bottom 1KHz of the band could still be used as a back up one day.

Please don't forget the annual WA5DJJ New Years Eve QRSS Celebration event. It's a time when every grabber and every transmitter is on the air on every band just to see what can be done. The celebration often lasts a week, so don't miss it. Plus there is quite a bit of winter time sporadic E in the northern hemisphere too, so 28Mhz can still give some surprise results.

And talking of events, maybe we should have a few others spread throughout the year. Maybe a themed, such as an all band midsummer madness event, or specialised 60m band trials ? And here's a thing, YOU can make these events. All you need to do is make an announcement There is no authority other than yourself. And it's a great life statement too. Just do it !

And finally, my favourite description of the Knights. **QRSS'ers they are like amateur radio's noiseless patient spiders, hiding in the noisy undergrowth, just below the WSPR bands or the bottom 1Khz band edge, they send their mating calls, and the grabbers wait silently for their prey.**