

ILERTENNA

End-Fed QRP Tuner Kit

Assembly Manual

Last update: February 01, 2017

ea3gcy@gmail.com

Updates and news: www.qsl.net/ea3gcy



Thanks for building this **ILERTENNA** kit for a QRP tuner for end-fed antennas

Have fun building it, enjoy QRP! 73, Javier Solans, ea3gcy

INDEX

INDEX.....	2
INTRODUCTION.....	3
TIPS FOR FIRST TIME BUILDERS.....	4
PARTS LIST.....	5
ASSEMBLY.....	6
RECOMMENDED BUILDING SEQUENCE.....	7
TOROIDAL TRANSFORMER T1.....	7
TOROIDAL TRANSFORMER T2.....	9
R1, R2 Y R3 PLACEMENT.....	10
POLYVARICON PLACEMENT.....	11
BCN CONNECTOR AND SWITCH PLACEMENT.....	12
ANTENNA TERMINALS PLACEMENT.....	14
WORKING WITH THIS TUNER.....	15
TIPS AND TRICKS.....	17
IF YOUR KIT DOES NOT WORK AFTER ASSEMBLY.....	18
WARRANTY CLAUSES.....	19
SCHEMATIC.....	20

INTRODUCTION

The most popular antenna is the center-fed dipole which has a nominal impedance about 75 ohms which can be easily adapted to a 50 ohm feed. When we want to feed a similar length antenna, such as the half wave through one of its ends, its impedance is close to 3000 - 5000 ohm and needs a transformation system to match to a 50 ohm transceiver.

In the 20s of the last century "zeppelin" airships encountered a problem when installing their huge communication antennas. Unlike the great ocean liners in which the antenna was hung between the masts, in the "zeppelin" it was impossible to use this system. The solution was to left it hanging feeding it through its end. The antenna was connected to a system to automatically deploy and rewind it for take off and landing, respectively. Such antennas were renamed as "zeppelin antennas". The "end-fed" antenna, as the name suggests, are similar to the "zeppelin" ones although the type of coupling is somewhat different.

The use of a half-wave antenna fed by one end has certain advantages compared to a conventional dipole. The impedance of the antenna is around 3000 - 5000 ohms and very little RF energy flows to ground. The coaxial cable from the tuner to the rig will act as a counter-antenna. If used as a vertical antenna, it is not necessary to use ground radials for improving the efficiency. The point of maximum radiation is at half the length of the antenna. For example, for a 40 meter antenna, if it is hanging vertically from a tree or pole the point of maximum radiation is 10 meters above ground level, without having to have radials on the ground.

Obviously, installing an end-ed antenna is really very easy. In practice, especially for QRP enthusiasts who like to do field trips, the antenna has important advantages: it only needs a fixing point, usually a tree or a fishing rod, and requires little or no coaxial cable, thus saving weight in the backpack.

PLEASE, READ AT LEAST ONCE AND THOROUGHLY ALL THE ASSEMBLY INSTRUCTIONS PRIOR TO BUILDING SESSIONS.

TIPS FOR FIRST TIME BUILDERS

Tools Required:

- Small tipped soldering of about 25-30 W rating, good quality soldering tin for electronic work, small side cutters, wire strippers, long strippers, long nosed pliers, a sharp knife hobby "cutter", a screw driver for the M 2,5 bolts.
- You need a good light and a magnifying glass to see fine print on the parts and other building details.

Soldering:

There are two important things which need to be done to ensure the successful operation of a kit. One is getting the right part into the proper place on the board, the second is good soldering. To solder properly, you must use the correct type of iron and the right quality of solder. Use a small tipped soldering iron which has a bit that is short and almost pointed at end. The iron should be about 25-30 Watts (if it is not thermostatically controlled). Use only electronic type multicore solder. NEVER use any extra flux. You should hold the hot iron in contact with both the board and component lead for about two seconds to heat them up. Then, keeping the iron in place, touch the solder onto the junction of lead and track and wait about two second or so until the solder to flow along the lead and track to form a good joint. Now remove the iron. The iron should have been in contact with the work piece for a total time of about 4 seconds in all. When soldering leads going to the ground plane of the board, you will need to preheat the union longer to get a good flow of the molten tin. It is highly recommended to clean and remove the remaining tin from the iron tip after each soldering (most of the holders have a sponge for this); this helps to avoid old tin on the tip and residues from previous operations.

PARTS LIST

Componentes electrónicos					
	Quantity	Referencia	Value	Part Type	Identification
	2	R1	50 Ω	2 resistors 100 Ω (see text)	brown-black-brown
	2	R2	50 Ω	2 resistors 100 Ω (see text)	brown-black-brown
	2	R3	50 Ω	2 resistors 100 Ω (see text)	brown-black-brown
	1	R4	1K	Resistor 1K	brown-black-red
	1	C1/C2	Polyvaricon	Polyvaricon 160 + 70 pF	--
	1	C3	100 nF	Capacitor	104 o 0.1
	1	D1	1N4148	Diode	4148
	1	LED	--	3 mm LED	--
	1	T1	T50-6	Yellow Toroid 12.5 mm diam. (½ in)	--
	1	T2	FT37-43	Black Toroid 9.5 mm diam. (3/8 in)	--

Componentes mecánicos			
	Cantidad	Referencia	Pieza. Comentarios
	1	1591MBK	Plastic Box 85 x 50 x 22 mm.
	2	BR300	Antenna terminals 4 mm (one red, one black)
	1	BNC	Female BNC connector for panel.
	1	SW1 DPTD	DPDT switch
	1	Botón	Knob for 6 mm DPDT switch shaft
	1	2.5x12	Screw 2,5 x 12 mm for the Polyvaricon shaft
	2	2.5x4	Screws 2,5 x 4 mm for holding the Polyvaricon
	1	Shaft	6 mm shaft for the Polyvaricon
	65 cm	0.5 mm wire	62 cm enameled wire 0.5 mm required for T1
	50 cm	0.5 mm wire	46 cm enameled wire 0.3 mm required for T2
	1	PCB Ilertenna	PCB 85 x 50 mm

ASSEMBLY

The assembly of the ILERTENNA is very easy. Please notice that the PCB does not have any hole for part insertion. All parts are soldered over the pads as if they were for Surface Mounting. See the pictures.

Resistors R1, R2, and R3 are composed by resistor couples which will be soldered as per the pictures (see "Placement of R1, R2, and R3"). Toroidal transformers T1 and T2, as well as the polyvaricon need special attention as addressed on this manual.

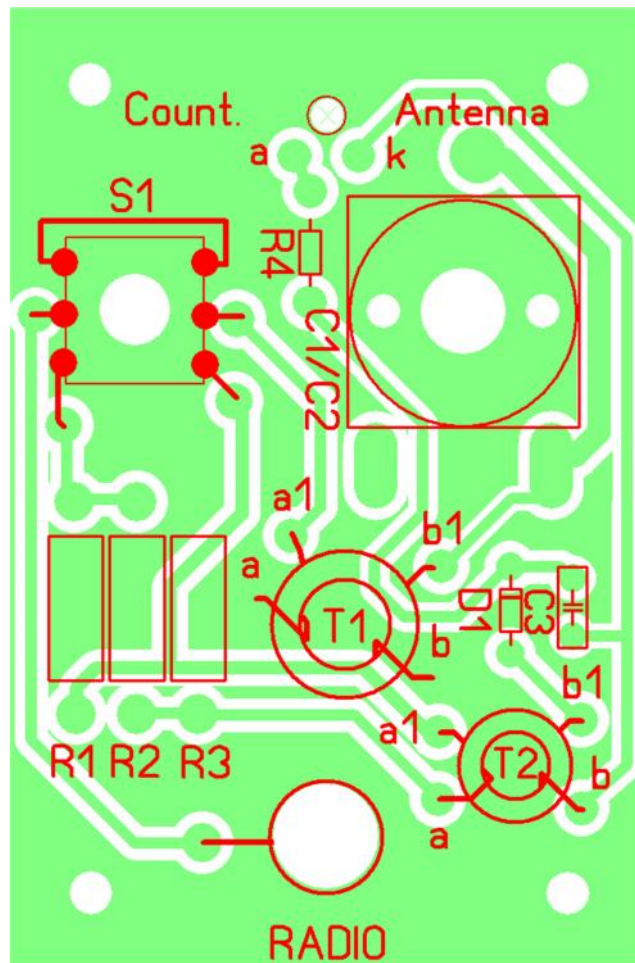

IMPORTANT

The front panel of the ILERTENNA serves also as the PCB for placing the parts.

Take care not to scratch it during assembly. It may be a good idea to place it while assembly over cloth or other protecting material.

RECOMMENDED BUILDING SEQUENCE

For an easier assembly the following procedure is proposed:

- 1.- Prepare and solder toroidal transformers T1 and T2 in place (see the specific chapters).
- 2.- Install R4 of 1K ohms. Cut the legs accordingly.
- 3.- As with the resistor, install D1 diode 1N4148, taking care with the placement of the side with the black bar which should follow the silkscreen outline.
- 4.- Prepare the legs of capacitor C3 of 100 nF (104) and solder it on place.
- 5.- Insert the LED on the PCB hole so it protudes on the frontal side about 1-2 mm (1/16 in). Tweak the legs and solder them on place. The longest lead goes to the "a" pad whereas the short one goes to the "k" pad.
- 6.- Place the resistor couples R1, R2, and R3 (see the specific chapter).
- 7.- Place and solder the Polyvarycon (see the specific chapter).
- 8.- Place the switch and hold it on place with its nut and washer. Take care when fixing to avoid scratching the front panel. Make the connections as indicated by the specific chapter.
- 9.- Install the female BNC connector on the PCB and hold it with its washer and nut. Take care when fixing to avoid scratching the front panel. Make the connections as indicated by the specific chapter.
- 10.- Install the antenna terminals (see the specific chapter), put the knob over the axe of the Polyvaricon and finish assembling the box.

Toroide transformador T1

Transformer T1 is used to adapt the end-fed dipole impedance to the 50 ohms of the transmitter. It is made on a yellow T50-6 toroid with a diameter of 12.5 mm (1/2 in). The secondary has 28 turns whereas the primary has 4 turns. For both windings enameled wire of 0.5 mm, provided with the kit, is used. Cut about 50 cm of wire and make twenty eight (28) turns as indicated on the picture. This will be the secondary winding and will be soldered to pads "b" and "b1" on the silkscreen outline.



Make tight turns, following the contour of the toroid so turns are taut. Spread the turns over the toroid and leave 10 mm (0,4 in) pigtails. Scratch and remove the enamel so the pigtails may be soldered. Turn counting: every time that the wire goes through the inner hole of the toroid it counts as one turn.

IMPORTANT: prepare the coil as indicated on the pictures. The winding direction in both primary and secondary windings is important.

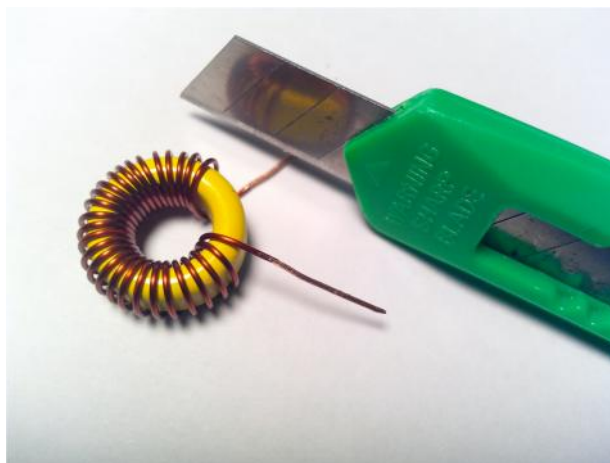

Then cut a 10-11 cm (4 – 4 ¼ in) piece of 0.5 mm enameled wire and make four (4) turns in the opposite side of the toroid (see the picture). This is the primary winding and will be soldered to pads “a” – “a1”. Leave 10 mm (0,4 in) long pigtails. Scratch and remove the enamel so the pigtails may be soldered.

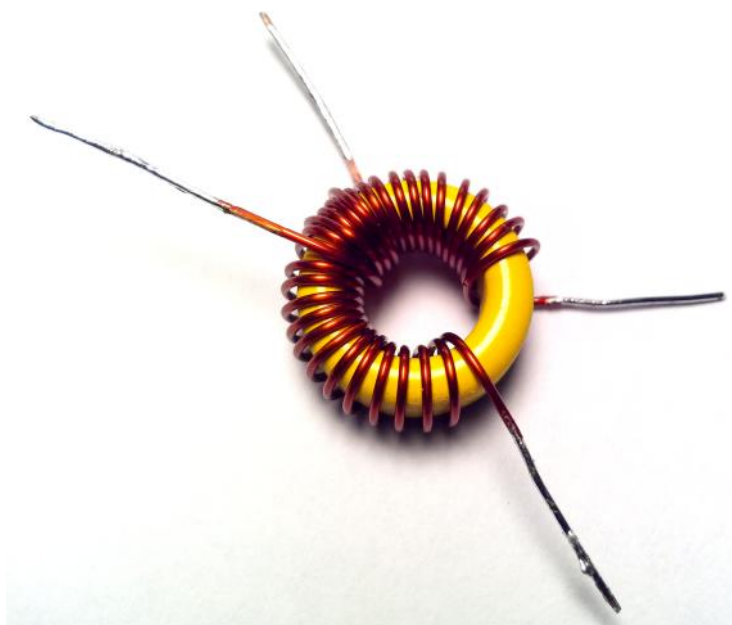

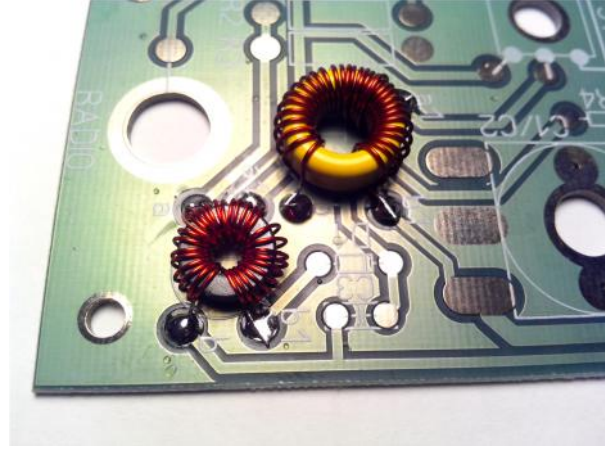
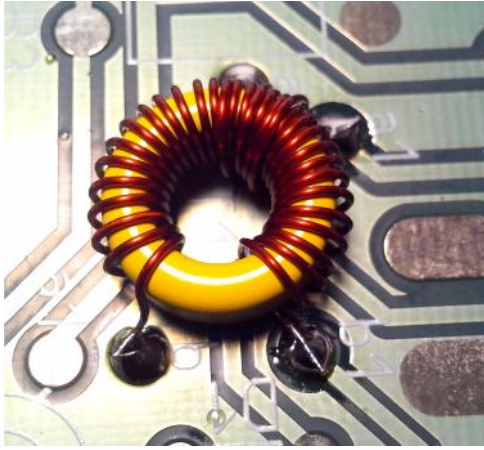

Cut the pigtails to fit the pads and solder them to their correct pads “a” –“a1” and “b” – “b1” around T1. Be sure of their correct orientation. This toroid may be left touching the board or slightly separated, 1-3 mm (1/16 in) over the board.

Toroidal transformer T2

Transformer T2 is used to pick up a signal and feed a LED which indicates the tuning soft spot when its light diminishes. It is made on a black FT37-43 toroid with a diameter of 8.5 mm (3/8 in). The secondary has 23 turns whereas the primary has 5 turns. For both windings enameled wire of 0.3 mm, provided with the kit, is used. Cut about 35 cm of 0.3 mm wire and make twenty three (23) turns as indicated on the picture. This will be the secondary winding and will be soldered to pads “b” and “b1” on the silkscreen outline. Leave 10 mm (0,4 in) pigtails and scratch and remove the enamel so the pigtails may be soldered.

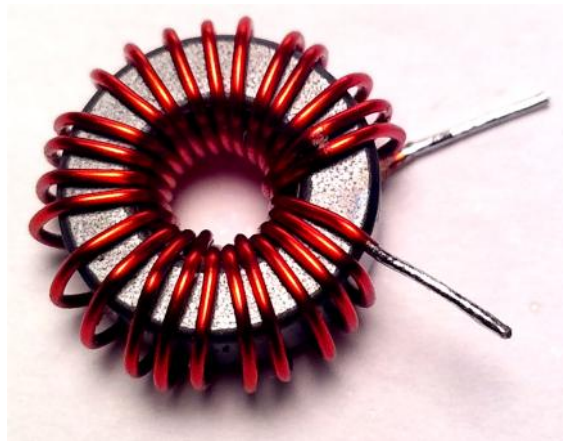

Then cut a 10 cm (4 in) piece of 0.3 mm enameled wire and make five (5) turns in the opposite side of the toroid (see the picture). This is the primary winding and will be soldered to pads “a” – “a1”. Leave 10 mm (0,4 in) long pigtails. Scratch and remove the enamel so the pigtails may be soldered.

IMPORTANT: Wind the toroids exactly as indicated on the pictures.

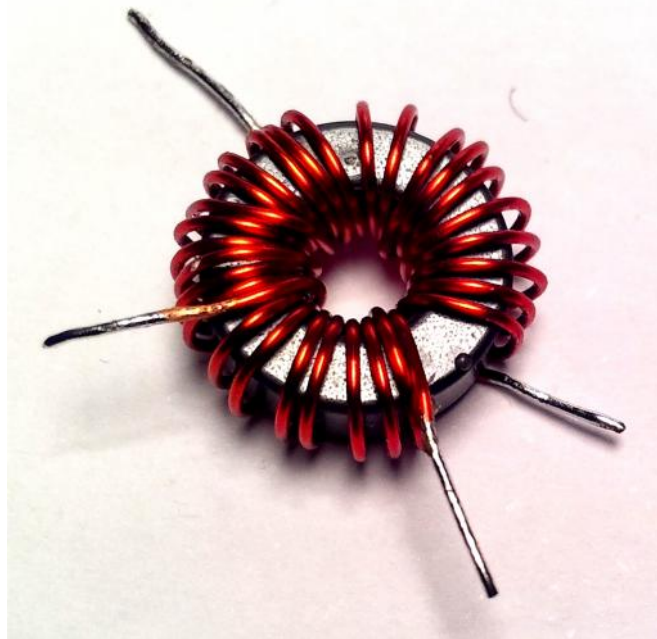

As with T1, cut the pigtails to fit the pads and solder them to their correct pads “a” –“a1” and “b” – “b1”. Be sure of their correct orientation. This toroid may be left touching the board or slightly separated, 1-3 mm (1/16 in) over the board.

Installation of R1, R2 y R3

R1, R2 and R3 resistors are composed by three pairs of 100 ohms resistors so that three 50 ohm resistors are obtained.

As shown in the pictures, first solder a resistor and then place another on top soldering it to the leads of the first. Leave about 2mm clearance between the PCB and the resistor, and a similar clearance to the resistor above. Repeat this procedure for all three locations (R1, R2 and R3).

They may also be prepared off-board, slightly twisting their leads and soldering them prior to their insertion on the PCB.



Installation of POLYVARICON

Install the shaft on the POLYVARICON with one M 2.5x12 screw.

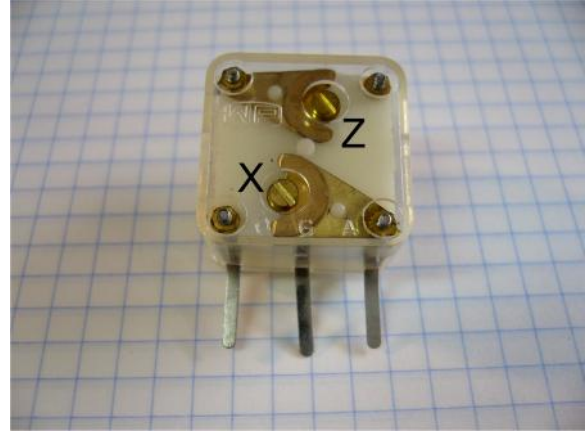
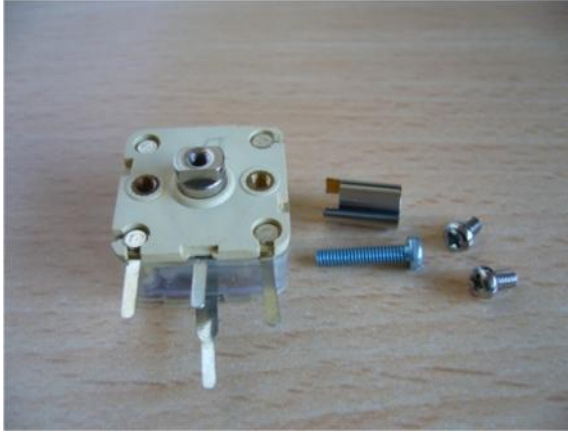

Install Polyvaricon on board and fix it with two M 2.5x4 screws.

Solder its three terminals to the correct pads.

Although only one section of the Polyvaricon is used, adjust both "Padders" "X" and "Z" to their minimum capacity so that the tuner can be used on the higher bands (up to 15 m). This is achieved by placing the rotor (looks like a "half moon") outside of the "padder" plates; The following photo shows the two "Padders" adjusted to minimum capacity.

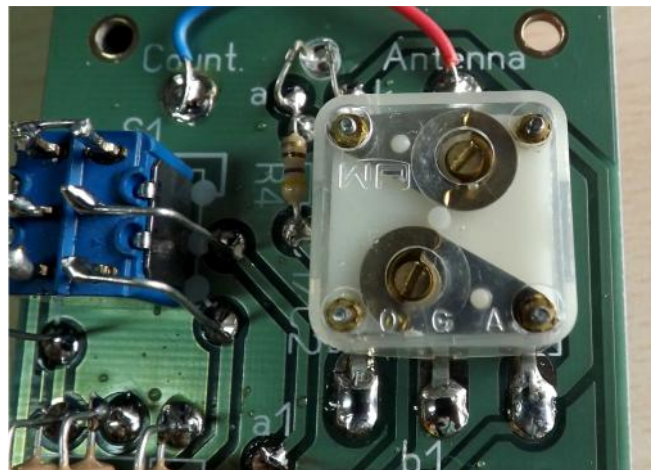

SWITCH and BNC Connector

Install the switch and the female BNC connector on the board as shown on the following pictures. Use a few pieces of thin rigid or flexible wire.

Look carefully at the wiring of the switch, the top two terminals are connected together, and the remaining four are connected to board pads.

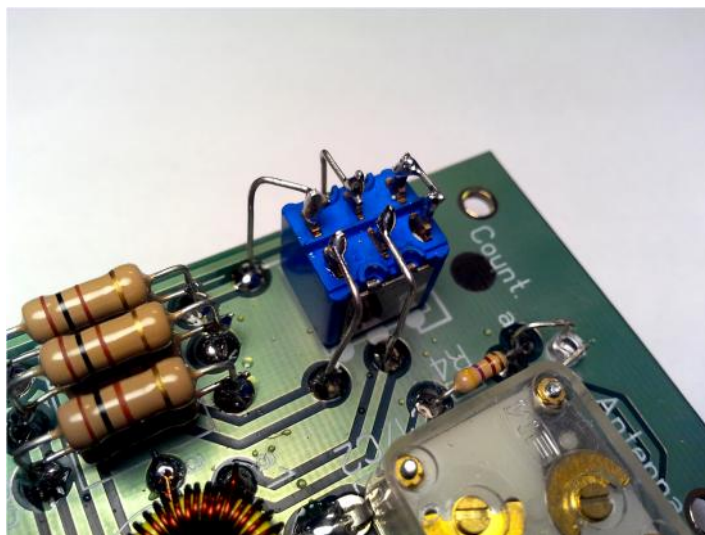

The BNC connector is easy to install. Screw it onto the plate and connect the center terminal to the pad.

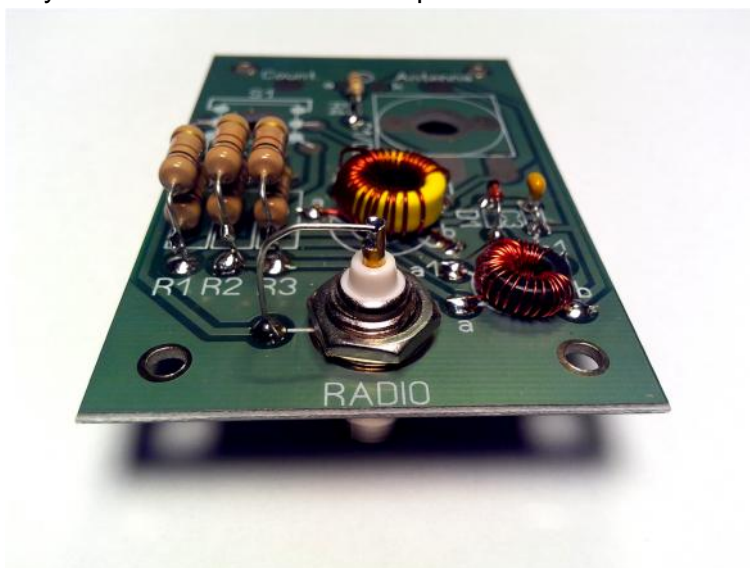



Installation of ANTENNA TERMINALS

Place the red and black terminals as shown in the picture.

IMPORTANT: Place the two plastic insulating "cylinders" on the outside of the box, otherwise the Polyvaricon and other internal elements would make contact to the terminals, making difficult to close the box.

With two pieces of wire as short as possible connect the black terminal to the "Count" pad and the red one to the "Antenna" pad.

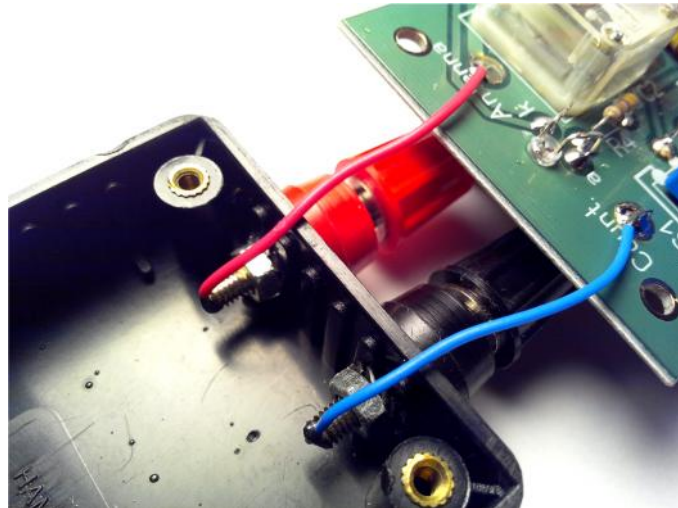

There are three ways to connect the antenna wire to the terminals: Direct connection of the wire to the terminals, banana plugs or ring terminals.

Personally I recommend using ring terminals. See the pictures below.



HOW TO USE THE TUNER

You will find lots of information about the end-fed antennas on internet. There are hundreds of ideas and tips on its length, holding systems, ways of use, etc.

ANTENNA

With the right length of antenna wire the ILERTENNA can be used within the 40-15 m bands. This kind of tuners may work without an antenna counterpoise, so it is not necessary to connect anything on the terminal marked "Counterp.". You will only need to connect a ½ wave wire to the "Antenna" terminal; in this case the coaxial cable to the transceiver, the transceiver itself, and the microphone cable or CW keyer will act similarly to a counterpoise wire.

A half-wave wire for the 40 m band (about 20, 35 meters) can also be tuned to the 20 m band. However, best performance is obtained by using the length of a half-wave antenna for the specific band. You can use the following equation: $142.5 / \text{Freq (MHz)}$ with the result in meters.

See next table:

Band	40 m	30 m	20 m	17 m	15 m
Lenght	20,35 m	14,25 m	10,2 m	7,90 m	6,8 m

Although not essential, many authors advise to use certain wire length as counterpoise. You can use the following table:

Band	40 m	30 m	20 m	17 m	15 m
Antenna	19,2 m	13,4 m	9,6 m	7,47 m	6,4 m
Count.	10,67 m	7,31 m	5,33 m	4,11 m	3,5 m

As with all antennas, for maximum efficiency it is important to place it in a high and clear place as possible. A badly placed antenna close to the ground or near conductive elements as power lines, concrete constructions, etc. will have a degraded efficiency and even it will prevent to achieve a proper tuning.

OPERATION

The operation of this type of tuners is extremely simple:

- **Set the switch to the "TUNING" position and transmit.**
- **Adjust the tuning knob until the LED almost goes out or dimms as much as possible.**
- **Stop transmitting.**
- **Flip the switch to the "OPERATE" position**
- **The antenna is now tuned. You may now transmit normally.**

The adjustment point is not very critical. Normally not more than 2-3 seconds are needed to find the best fit. You can also preset the tuning without transmitting (by listening to the signals and / or noise band and adjusting the knob to maximum signal or maximum noise). Use the minimum time for setting (when switched to "TUNING").

Note that the LED may not be completely off although the antenna is adjusted OK. This is normal and happens more frequently whenever high power is used on the higher bands.

In "OPERATE" position the LED will light up slightly in the tuning point (unlike the "TUNING" position). This is also normal as some of the RF flowing through the tuner is picked up by the indicating circuit.

REMEMBER:

DO NOT EXCEED THE 5 W CW OR 10 W PEP LIMIT

ATTENTION:

AT THE FEEDING POINT OF THE ANTENNA THERE IS A VERY HIGH VOLTAGE, EVEN WITH 5 W OUTPUT. NEVER TOUCH THAT POINT WHEN ADJUSTING OR TRANSMITTING.

TIPS AND TRICKS

FRONTAL FINISH

The ILERTENNA front panel is also the printed circuit board where the parts are soldered. This board is cut into a rectangular shape, with sharp corners. It may be a good idea to sand the edges off a bit to round them up to match the box; this way you will get a better cosmetic finish.

Another interesting idea is to apply a protective coating to the front surface. The painting of the plate is not very durable and therefore a suitable varnish may help to protect it.

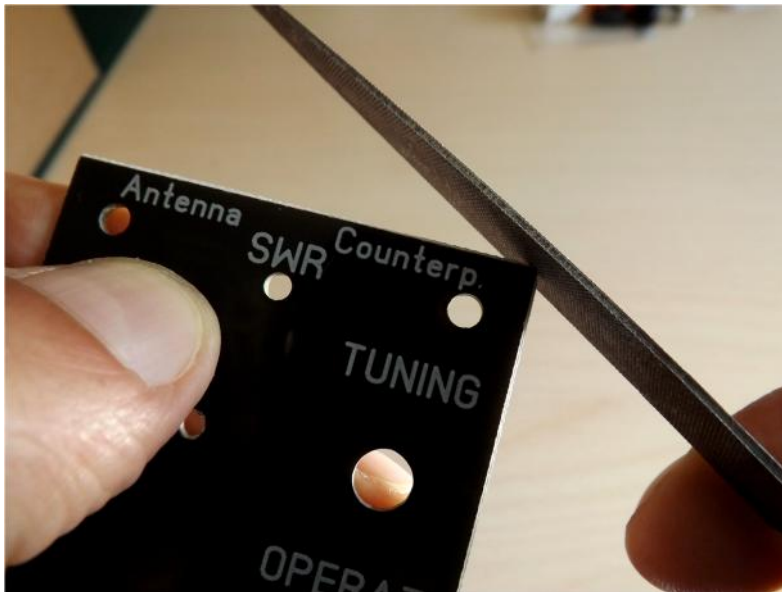

POLYVARICON AND T1

Note that in the assembly of the ILERTENNA only one section of the Polyvaricon capacitor is used: the one with 160 pF, suitable for the bands between 40 and 15 meters. The other section has about 70 pF. If you intend to use antennas only for 17 to 10 m bands, the tuning will be easier using the 70 pF section of the Polyvaricon. You can also experiment by removing some turns of the toroid T1 to achieve an easier tuning on those bands.

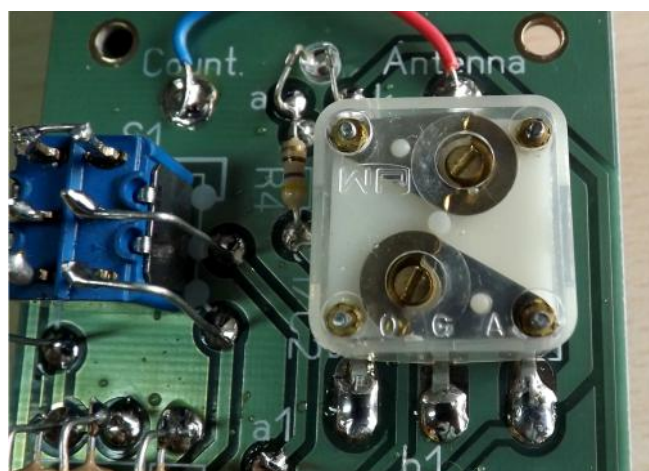

LED

Note that the LED may not be completely turned off, although the tuner is adjusted OK. This is normal and happens more frequently on the higher bands when using higher power. You can try to decrease the brightness of the LED by increasing the value of R4 or by removing some turns of the secondary winding (the one with 23 turns) of the T2 toroid.

30 to 10 meters MODIFICATION

Wind T1 with **19** turns secondary and **3** turns primary. Work from 30 to 10 meters (10 to 30MHz).

IF YOUR KIT DOES NOT WORK AFTER ASSEMBLY

Don't worry, it is not uncommon a non working kit on the first try; be calm as in the majority of cases they are small mistakes with a simple fix. Most faults are due to poorly soldered connections or misplaced parts; it is very rare to find a faulty part. Before taking any measurements with instruments, check all connections, inspect your soldering work looking for cold connections, shortcircuits between tracks or parts placed in the wrong place. If your kit does not work after final assembly, please follow these steps in order:

- Double-check every step in the assembly manual, pads soldered, and right parts placed in their right position.
- If you have access to instrumentation, take readings, and follow the signals on the circuit to diagnose what is happening and why.
- Talk to a ham with experience on kits or a technician to check your work. A fresh look to your circuit may find things you had overlooked.
- In case of need, your request for technical assistance by email to ea3gcy@gmail.com is welcomed.

As a last resource, you may send the kit for a repair; I will have to charge, though, the repair needed, but I will try the cost will be as moderate as possible.

WARRANTY CLAUSES

Please read carefully BEFORE building your kit

All parts and hardware supplied with the kit are under warranty in case of manufacturing defect for the period of one year after sale.

The original purchaser has the option of examining the kit and manual for 10 days. If, within this period, the buyer decides not to build the kit, he or she may return the entire unassembled kit at their own expense. Shipping charges included on the kit price and sale commissions (by banks or "Paypal", etc) won't be returned.. Please, BEFORE making a return, ask for directions by email to: ea3gcy@gmail.

Javier Solans, ea3gcy, warrants this device to function as described in this documentation provided that it is assembled and used correctly according to all printed instructions. It is your responsibility to follow all directions in the instruction manual, to identify parts correctly, and to use good workmanship and proper tools and instruments in constructing and adjusting this kit. REMEMBER: This kit will not work as a commercially manufactured set, however, can often give similar results. Do not expect great performance, but it is sure that you will have a lot of fun!

If you notice a missing kit part missing, please do first a thorough inventory. Check all bags, envelopes or boxes carefully. If need be, email me and I will promptly replace any missing part. Even in the case that you find the exact replacement locally, please let us know so we are aware of the problem and get ready to help other customers. I can also supply any part that you have lost or break accidentally. If you find any errors in this manual or would like to make a comment, please do not hesitate in contacting me at: ea3gcy@gmail.com

THANKS for building the end-fed tuner ILERTENNA kit.
Enjoy QRP!

73 Javier Solans, ea3gcy

SCHEMATIC

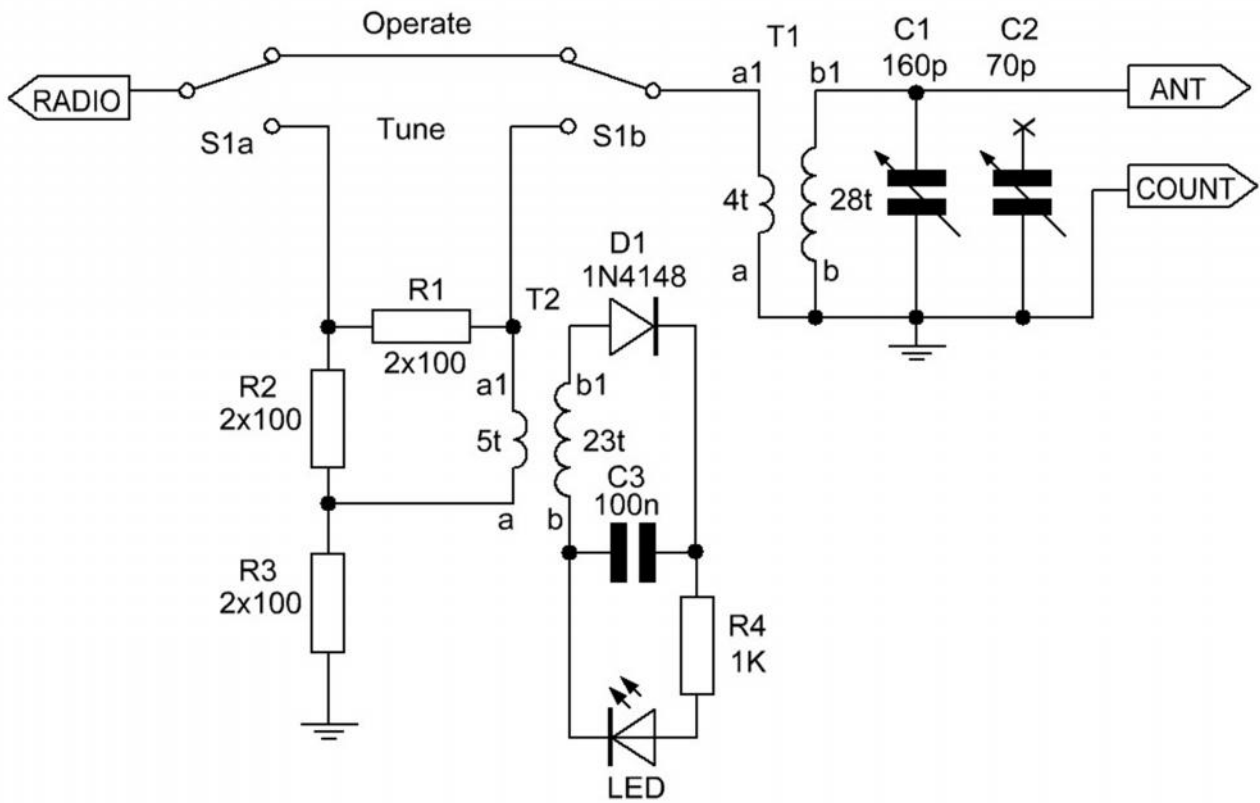

ILERTENNA