

144/430 (440) MHz FM DUAL BANDER

TM-D710A/D710E

SERVICE MANUAL

KENWOOD

Kenwood Corporation

© 2007-8 PRINTED IN JAPAN
B51-8801-00 (N) 281

This service manual details the panel section.
Refer to the TM-V71A/V71E service manual
(B51-8791-00) for any information which has
not been covered in this TM-D710A/D710E
service manual.



Photo is TM-D710A.

CONTENTS

CIRCUIT DESCRIPTION	2	PC BOARD	
SEMICONDUCTOR DATA	6	DISPLAY UNIT (X54-3620-00)	52
COMPONENTS DESCRIPTION	9	TX-RX UNIT (X57-731X-XX)	56
TERMINAL FUNCTION	10	INTERCONNECTION DIAGRAM	64
PARTS LIST	12	SCHEMATIC DIAGRAM	66
EXPLODED VIEW	29	BLOCK DIAGRAM	80
PACKING	30	LEVEL DIAGRAM	82
ADJUSTMENT	31	OPTIONAL ACCESSORIES	84
		SPECIFICATIONS	85



Document Copyrights

Copyright 2007 by Kenwood Corporation. All rights reserved.

No part of this manual may be reproduced, translated, distributed, or transmitted in any form or by any means, electronic, mechanical, photocopying, recording, or otherwise, for any purpose without the prior written permission of Kenwood.

Disclaimer

While every precaution has been taken in the preparation of this manual, Kenwood assumes no responsibility for errors or omissions. Neither is any liability assumed for damages resulting from the use of the information contained herein. Kenwood reserves the right to make changes to any products herein at any time for improvement purposes.

CIRCUIT DESCRIPTION

1. Outline

TM-D710A/D710E and TM-V71A/V71E have a common main unit. Thus, the main unit firmware is also common to both.

The command formats of the panel connected to the main unit are different for TM-V71A/V71E and TM-D710A/D710E. So, the main unit section MPU (IC918) judges the type of the panel connected, when power is turned on and communication starts.

2. Frequency Configuration

The TM-D710A/D710E has an individual VCO and PLL unit for both band A and band B. Using these separate VCO and PLL circuits, it can receive 2 separate bands at the same time. You can also perform full-duplex operation.

The band A VCO is used for the following functions:

- (i) VHF/UHF transmission
- (ii) The first local oscillator for the band A (VHF) reception.

- (iii) The first local oscillator for the band A (UHF) reception.

The band B VCO is used for the following functions:

- (i) VHF/UHF transmission
- (ii) The first local oscillator for the band B (VHF) reception.
- (iii) The first local oscillator for the band B (UHF) reception.

The PLL reference frequency is generated by a 12.8MHz (band A) and a 16.8MHz (band B) crystal oscillator connected to the band A and band B PLL ICs. This reference frequency is used for both PLL circuits. The 45.505MHz second local oscillator for band A is generated by the FM IC crystal oscillator circuit. The second local oscillator for the band B uses the tripled 16.8MHz reference oscillator frequency.

Note:

The PCB layout and the mounting parts are the same for the band A VCO (X57-731 B/6) and band B VCO (X57-731 C/6), although the PCB silk print is different.

CIRCUIT DESCRIPTION

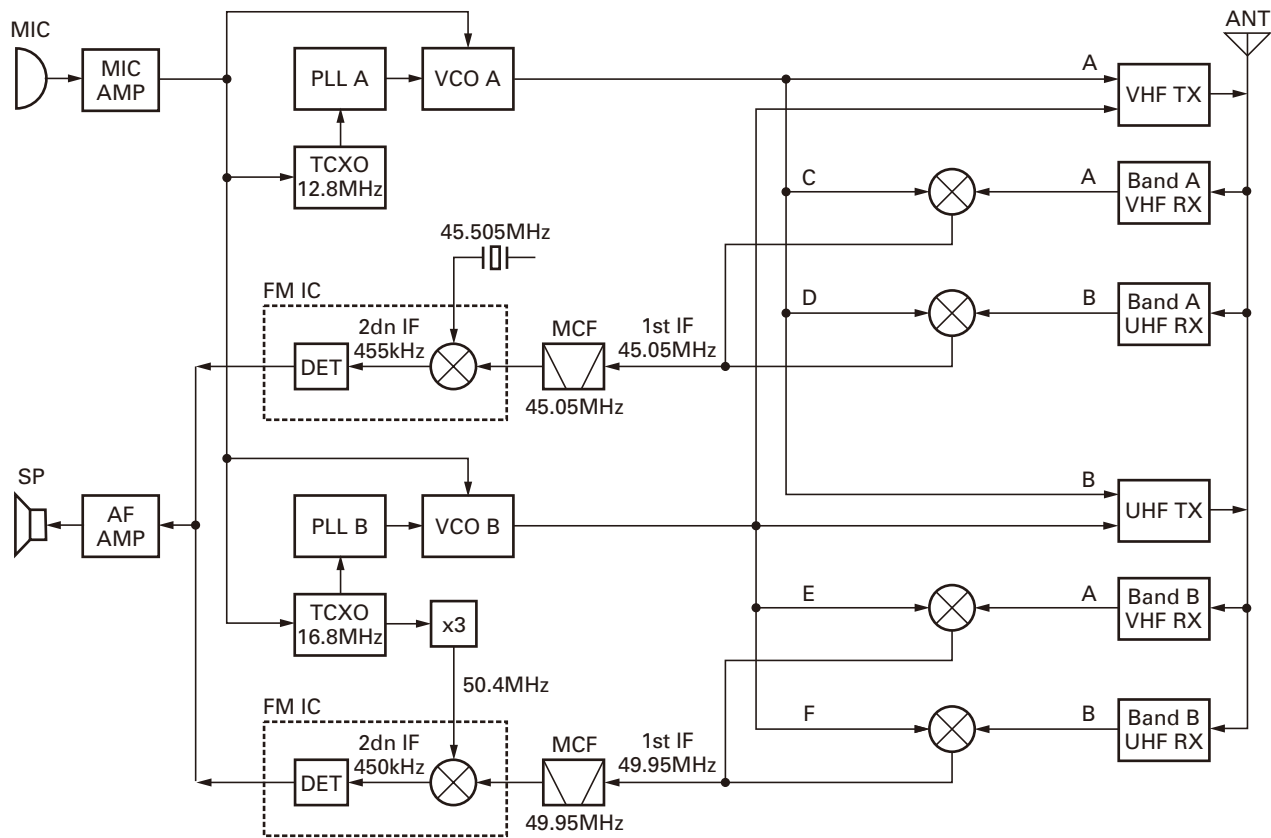

	K type	E type	M4 type
A	144.000 ~147.995MHz	144.000~145.995MHz	144.000~145.995MHz
B	438.000~449.995MHz	430.000~439.995MHz	430.000~439.995MHz
C	189.050~193.045MHz	189.050~191.045MHz	189.050~191.045MHz
D	392.950~404.945MHz	384.950~394.945MHz	384.950~394.945MHz
E	193.950~197.945MHz	193.950~195.945MHz	193.950~195.945MHz
F	388.050~400.045MHz	380.050~390.045MHz	380.050~390.045MHz

Fig. 1 Frequency configuration

Band A 1st IF: 45.05MHz, 2nd IF: 455kHz (Upper)

RX frequency range [MHz]		VCO oscillation frequency range [MHz]		Multiply	VCO V/U IC576 pin 7	VCO shift IC576 pin 12	1st Mix.	Local frequency range [MHz]	
1	2	3	4					5	6
118.000	129.995	163.050	175.045	1	H	L	Upper	163.050	175.045
130.000	185.995	175.050	231.045	1	H	H	Upper	175.050	231.045
186.000	224.995	140.950	179.945	1	H	L	Lower	140.950	179.945
225.000	279.995	179.950	234.945	1	H	H	Lower	179.950	234.945
280.000	359.995	325.050	405.045	1	L	L	Upper	325.050	405.045
360.000	399.995	405.050	445.045	1	L	H	Upper	405.050	445.045
400.000	429.995	354.950	384.945	1	L	L	Lower	354.950	384.945
430.000	523.995	384.950	478.945	1	L	H	Lower	384.950	478.945

TM-D710A/D710E

CIRCUIT DESCRIPTION

Band B 1st IF: 49.95MHz, 2nd IF: 450kHz (Upper)

RX frequency range [MHz]		VCO oscillation frequency range [MHz]		Multiply	VCO V/U IC577 pin 7	VCO shift IC577 pin 12	1st Mix.	Local frequency range [MHz]	
Start	End	Start	End					Start	End
136.000	185.995	185.950	235.945	1	H	H	Upper	185.950	235.945
186.000	224.995	136.050	175.045	1	H	L	Lower	136.050	175.045
225.000	279.995	175.050	230.045	1	H	H	Lower	175.050	230.045
280.000	359.995	329.950	409.945	1	L	L	Upper	329.950	409.945
360.000	399.995	409.950	449.945	1	L	H	Upper	409.950	449.945
400.000	429.995	350.050	380.045	1	L	L	Lower	350.050	380.045
430.000	523.995	380.050	474.045	1	L	H	Lower	380.050	474.045
800.000	823.990	375.0250	387.0200	2	L	L	Lower	750.050	774.040
824.000	909.990	436.9750	479.9700	2	L	H	Upper	873.950	959.940
910.000	1109.990	319.9833	386.6467	3	L	L	Upper	959.950	1159.940
1100.000	1209.990	350.0167	386.6800	3	L	L	Lower	1050.050	1160.040
1210.000	1299.990	314.9875	337.4850	4	L	L	Upper	1259.950	1349.940

RX BPF switching frequency

	VHF BPF	UHF BPF
Band A	118~279.995MHz (5RVA : ON)	280~523.995MHz (5RUA : ON)
Band B	136~279.995MHz (5RVB : ON)	280~523.995MHz (5RUB : ON)

VHF BPF shift frequency

BPF shift switch	RX frequency	
	~199.995MHz	200MHz~
IC576 pin 16	L	H
IC577 pin 17	L	H

3. Panel Section

The panel section consists of the control section, the TNC section and the full-dot LCD (235×65 dots) display section.

The flash-type panel MPU (IC1) is used in the panel section and the firmware can be rewritten. Also, the panel MPU has no program for controlling frequency, so it is common for all types.

3-1. Power Supply Circuit

10V is always supplied to the panel section even if the power of the main unit is turned off, as long as the main unit is connected to a power supply such as battery. Power is applied to the panel MPU through the 5V AVR (IC6) and the panel section is operating in standby mode.

When in standby state, the LCD power, the RS-232C circuit power and the TNC power are turned off with switches Q1, Q2, and Q3 respectively, in order to reduce power consumption.

The reset signal of the panel MPU (IC1) detects the rising edge of the voltage of the 5V line with the voltage detection

IC (IC3). The voltage detection IC (IC24) detects the reduced voltage of the 10V power line and backs up the state immediately before the voltage becomes approximately 8V or less, to the EEPROM (IC2).

The voltage detection IC (IC14) monitors the TNC-5V line and the reset signal of the TNC MPU (IC11) performs reset operations.

The backup battery circuit divides the 5V voltage always applied with R115 and R116 and floating-charges the internal rechargeable lithium battery through the reverse current prevention diode (D3). The voltage of the battery is approximately 3.1V when fully charged.

The internal rechargeable lithium battery backs up the data of the S-RAM (IC13), RTC (IC25) and logic IC (IC15). The backup current of approximately 5μA is consumed. So, the data can be saved for approximately four weeks on a full charge.

The S-RAM is used for maintaining the status of the packet mode.

The call sign of the APRS and reception list are stored in the EEPROM.

CIRCUIT DESCRIPTION

3-2. Key, Encoder, Volume Input Circuit

The panel section key corresponds to the panel MPU port, one-to-one. The POWER key is pulled up and connected to the interrupt port of the panel MPU.

Other keys are also pulled up outside because the panel MPU is an 8 bit data bus mode. The scanning process reads out the status of the keys. So, if a key is in the "L" level, no other keys are accepted.

The encoder is connected to the panel MPU and the port is pulled up.

The volume (VOL/SQL) divides the 5V voltage, reads with the A/D port of the panel MPU and transfers the data to the main unit section MPU (IC918).

3-3. Display Circuit

The LCD is a COF (Chip On Flexible printed circuit board) type with the driver IC mounted on the FPC and controlled by the 8 bit data bus mode. The voltage "V3" is approximately 12V for the LCD, but due to the voltage booster function of this driver IC, it can operate with a single power of 5V.

The contrast can change this "V3" voltage by 16 steps, using the internal memory of the driver IC.

3-4. Brightness Circuit

The illumination color can be set to either amber or green.

The PWM signal output from the panel MPU passes through the LPF, is converted into DC voltage, and controls the current that flows to the LED with the transistor. The duty of the PWM changes the LED brightness to one of eight levels or OFF.

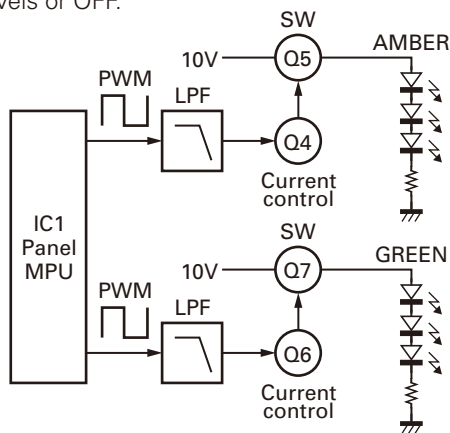

Fig. 2 Brightness circuit

3-5. TNC Section

The reception data signal from the main unit is input to the panel section through the PRI terminal (pin 8 of the modular jack of the panel section). This signal is the same as the PR9 signal of the DATA terminal. So, the data signal enters the panel section through the same route for both 1200bps and 9600bps.

The reception data signal from the PRI terminal passes the LPF (gain: 0, cutoff frequency: 4.8kHz) of IC22, adjusts the output with the electric volume (IC20) and the data signal enters the operational amplifier (IC10). The output adjustment value of the electric volume is fixed. The data signal of 1200bps and 9600bps is divided with the op-amp (IC10). Each data signal passes the buffer amp and is converted to a logic signal by the comparator (IC17).

The logic signal converted with the comparator enters to the TNC ASIC (IC12). The signal is demodulated with the TNC ASIC and is then processed with the TNC MPU (IC11).

For packet mode, signals processed with the TNC MPU enter to the panel MPU. The digital signals are not changed in the panel MPU. The level of the signal is changed with the RS-232C driver IC (IC7) and the signals are then output from the COM terminal (J2).

In APRS mode, the signal entering the panel MPU is processed and the status is displayed on the LCD.

The TNC section uses the same 3-chip TNC as the TM-D700. The flash-type TNC MPU is used and the firmware can be rewritten. The MPU clock operates at double frequency. TNC ASIC is an existing product. So, the frequency of the clock signal is divided by half with the flip-flop (IC16).

The S-RAM (IC13) has a capacity of 4M bits in order to operate smoothly in the KISS mode of packet communication.

Panel MPU: 30626FHPGKBXC (Display unit IC1)

Pin No.	Port Name	I/O	Function
1	2099EN	O	Chip enable output for serial-parallel conversion IC (BU2099FV)
2	RTC_SCL	O	RTC (RV5C386A) serial clock output (I2C bus)
3	LCD_RES	O	LCD driver reset terminal
4	CLOCK	O	Common serial clock output (EEPROM, DAC, serial-parallel)
5	DATA	O	Common serial data output (EEPROM, DAC, serial-parallel)
6	BYTE	I	Not used (5V)
7	NC	-	Not used (GND)
8	ENC_1	I	Encoder, B
9	SQCIN	I	Squelch state input from transceiver main unit
10	RESET	I	System reset
11	XOUT	O	System clock output (11.0592MHz)
12	VSS	I	GND
13	XIN	I	System clock input (11.0592MHz)
14	VCC	I	5V power supply
15	NMI	I	Not used (5V)
16	ENC_2	I	Encoder, A (INT)
17	RXD_INT	I	RXD detection interrupt from main unit UART terminal
18	INT	I	Power supply voltage fall detection interrupt
19	PKSOUT	O	PKS request output to transceiver main unit
20	AMBER	O	Brightness output PWM (Amber)
21	EEPCS	O	EEPROM (AT25256A) chip select output
22	EEPSI	I	EEPROM (AT25256A) serial data input
23	DA_EN	O	DAC (M62364) chip select output
24	BEEP	O	BEEP sound output
25	INTRA	I	RTC fixed-cycle interrupt terminal
26	GREEN	O	Brightness output PWM (Green)
27	RXD(TNC)	I	UART input from internal TNC terminal
28	TXD(TNC)	O	UART output to internal TNC terminal
29	TXD	O	UART output to main unit MPU
30	RXD	I	UART input from main unit MPU
31	CLKFLS	I	Not used (GND)
32	FLS_SW	I	Not used (5V)
33	TXD(PC)	O	UART data output to PC terminal
34	RXD(PC)	I	UART data input from PC terminal

Pin No.	Port Name	I/O	Function
35	S9600	I	Baud rate state input of TNC
36	PKSIN	I	Packet standby (PKS) state input of TNC
37	RDY	I	Not used (5V)
38	ALE	-	Not used
39	HOLD/EPM	I	Not used (5V)
40	HLDA	-	Not used
41	BCLK	-	Not used
42	RD	O	LCD driver RD terminal
43	BHE	-	Not used
44	WR	O	LCD driver WR terminal
45	MALED	I	Message state input to my station
46	TNCCTS	O	UART inhibiting signal output to TNC
47	TNCRTS	I	UART inhibiting signal input from TNC
48	LCD_CS0	O	LCD driver chip select
49	KEY_4	I	[MHz] key input
50	KEY_3	I	[MR] key input
51	KEY_2	I	[VFO] key input
52	KEY_1	I	[CALL] key input
53	KEY_8	I	[REV] key input
54	KEY_7	I	[TONE] key input
55	KEY_6	I	[F] key input
56	KEY_5	I	[KEY] key input
57~59	NC	-	Not used
60	VCC	I	5V power supply
61	NC	-	Not used
62	VSS	I	GND
63~69	NC	-	Not used
70	LCD_A0	O	LCD driver (Address bus)
71	PSW	I	Power switch detection interrupt
72	KEY_15	I	[PM] key input
73	KEY_14	I	[TNC] key input
74	KEY_13	I	[BAND SEL B] key input
75	KEY_12	I	[BAND SEL A] key input
76	KEY_11	I	[PF2] key input
77	KEY_10	I	[PF1] key input
78	KEY_9	I	[LOW] key input
79~86	LCD_D7~ LCD_D0	O	LCD driver (Data bus)
87	CONLED	I	Connection state input
88	STALED	I	The transmission remaining packet state input
89	GPSLED	I	GPS measurement state input

SEMICONDUCTOR DATA

Pin No.	Port Name	I/O	Function
90	RTC_SDA	I/O	RTC (RV5C386A) serial data I/O (I2C bus)
91	VOL_B	I	AF VOL (Band B) A/D input
92	VOL_A	I	AF VOL (Band A) A/D input
93	SQL_B	I	SQL (Band B) A/D input
94	AVSS	I	GND
95	SQL_A	I	SQL (Band A) A/D input
96	VREF	I	Reference voltage
97	AVCC	I	Analog power supply
98	PCCTS	I	UART inhibiting signal input from PC
99	PCRTS	O	UART inhibiting signal output to PC
100	MBLED	I	Message board connection state input

TNC MPU: 3048BTE25KBYB (Display unit IC11)

Pin No.	Port Name	I/O	Function
1	VCC	-	5V power supply
2	HOSTCTS	I	CTS signal of asynchronous serial communication with host
3	SQ	I	Squelch input. H: With receive signal, L: No receive signal
4	PTT(PKSIN)	O	PTT output. H: Transmit, L: Receive
5	NC	-	Not used
6	NC	-	Not used
7	CONLED	O	CON LED Drive. H: Light off, L: Light on, During connection Light on
8	STALED	O	STALED Drive. H: Light off, L: Light on, Light on when transmit data exist.
9	NC	-	Not used
10	FWE(RESOUT)	I	Flash rewrite control
11	VSS	-	GND
12	GPSTX	O	3 chip TNC → Serial communication host data line
13	HOSTTX	O	3 chip TNC → Serial communication GPS data line
14	GPSRX	I	Host → Serial communication data line of 3 chip TNC
15	HOSTRX	I	GPS → Serial communication data line of 3 chip TNC
16	NC	-	L: Packet mode
17	GPSLED	O	Outputs 1-sec interval pulse when position determination data from GPS are received.
18	ABAUD1	I	Determine the communication speed with host by combination among ABAUD1~3. Set L for 9600bps.

Pin No.	Port Name	I/O	Function
19	ABAUD2	I	Determine the communication speed with host by combination among ABAUD1~3. Set L for 9600bps.
20	ABAUD3	I	Determine the communication speed with host by combination among ABAUD1~3. Set H for 9600bps.
21	CARRIER (D3(NC))	I	Carrier sense. L: With carrier, H: No carrier
22	VSS	-	GND
23	NC	-	Not used
24	NC	-	Not used
25	B_SEL	O	Clock divider circuit control. L: 1/2, H: 1/1
26	NC	-	Not used
27~34	D8~D15	I/O	Data bus of S-RAM D0~D7
35	VCC	-	5V power supply
36~43	A0~A7	O	Address bus of S-RAM A0~A7
44	VSS	-	GND
45~53	A8~A16	O	Address bus of S-RAM A8~A16
54	A17(NC)	O	(Address bus of S-RAM A17)
55	A18(NC)	O	(Address bus of S-RAM A18)
56	A19	O	(Inverted to CS of S-RAM)
57	VSS	-	GND
58	WAIT	I	WAIT. H: Fixed
59	MBODLED	O	MBOD LED control. H: Light off, L: Light on
60	MAILED	O	MAIL LED control. H: Light off, L: Light on
61	CLKOUT(NC) (CARRIER)	O	Clock output (7.9872MHz). H: Sleep
62	STBY	I	Hardware standby terminal. L: Hardware standby status (Sleep action)
63	RESET	I	Reset terminal. L: Reset status
64	SLEEP	I	Sleep terminal. H: Fixed
65	VSS	-	GND
66	X2	I	System clock input (15.9744MHz)
67	X1	O	System clock output (15.9744MHz)
68	VCC	-	5V power supply
69	NC	-	Not used
70	RD(OE)	-	Connected to RD terminal of S-RAM
71	HWR	-	Connected to WR terminal of S-RAM
72	NC	-	Not used
73	MD0	I	MPU mode setting. Normally, H
74	MD1	I	MPU mode setting. Normally, L
75	MD2	I	MPU mode setting. Normally, H

SEMICONDUCTOR DATA

Pin No.	Port Name	I/O	Function
76	VCC	-	5V power supply
77	VREF	-	5V power supply
78	TNC_SEL(VSS)	I	LOW
79	SPEC(VSS)	I	L: Fixed
80	GPS_SEL(VSS)	I	Selects GPS default. H: SONY(9600bps), L: NMEA(4800bps)
81	PLLOCK	I	Input from gate array
82	CLKEN(VSS)	I	MPU clock output selection. H: Output, L: No output
83	FLAG	I	Input from gate array
84	SIN	I	Inputs receive serial data from gate array
85	IODATA	I	Not used (GND)
86	VSS	-	Analog circuit GND
87	SCLKR	I	Clock input of receive data from gate array
88	SCLKT	I	Clock output of transmit data to gate array
89	IOCLK	I	Not used (GND)
90	IOEN	I	Extended output port data fixed control
91	NC	-	Not used
92	VSS	-	GND
93	SOUT	O	Serial data output to gate array
94	TXX	O	Transmit/receive switch output to gate array. H: Transmit, L: Receive
95	S9600	O	Output of gate array. H: 9600bps, L: 1200bps switch
96	WAY2	O	Output to gate array (Not used)
97	NC	-	Not used
98	LOOP	O	Output to gate array. (H: Loop back test in gate array)
99	PLLNT	O	Output to gate array (PLL lock follow-up)
100	HOSTRTS	O	RTS signal of asynchronous serial communication with host

Shift Register: BU2099FV (Display unit IC8)

Pin No.	Port Name	Signal name	Function	Active level
6	Q0	TNCWR	TNC flash rewrite switching terminal	L: Rewrite
7	Q1	PKTSW	1200bps/ 9600bps switching	L: ON
8	Q2	TNC_SEL	Switching between packet and APRS mode	L: Packet H: APRS
9	Q3	TNC_CAR	Carrier sense output to TNC(carrier information of transmit band)	L: With carrier H: No carrier
10	Q4	SQCOUT	Squelch status output to TNC	L: Receive H: Transmit
11	Q5	32K_SW	Control of adjustment mode of RTC crystal	L
12	Q6	S5M_C	RS-232C driver power supply control	L
13	Q7	TNC_PSW	TNC power supply control output	L
14	Q8	-	Not used	
15	Q9	LCD_SW	LCD drive power supply switch (V3)	
16	Q10	-	Not used	
17	Q11	-	Not used	

COMPONENTS DESCRIPTION

DISPLAY UNIT (X54-3620-00)

Ref. No.	Use / Function	Operation / Condition / Compatibility
IC1	Panel MPU	
IC2	EEPROM	
IC3	Voltage detection	Reset voltage for panel MPU
IC4	Buffer	RXD to TX-RX unit
IC5	Buffer	TXD to TX-RX unit
IC6	5V AVR	5V
IC7	RS-232C driver	for COM Port
IC8	Output expander	12bit serial input/ Parallel output
IC10	OP amplifier	RX data buffer
IC11	TNC MPU	
IC12	TNC ASIC	
IC13	S-RAM	
IC14	Voltage detection	Reset voltage for TNC MPU
IC15	Input NAND gate	TNC MPU reset control
IC16	Flip flop	1/2 Dividing frequency
IC17	Comparator	RX data
IC18	Comparator	RX 1200bps
IC19	Switching	TX1200bps/ TX9600bps
IC20	D/A converter	Port 1:TX data, Port 2:RX data
IC21	Buffer	SQC IN to TX-RX unit
IC22	OP amplifier	RX data LPF
IC23	RS-232C driver	for GPS port
IC24	Voltage detection	INT voltage for panel MPU
IC25	RTC	Timer
Q1	Switching	SW5V for LCD and Variable resistor volume
Q2	Switching	SW5V for RS-232C driver IC
Q3	Switching	SW5V for TNC ASIC and TNC MPU
Q4	Switching	Amber LED 10V control
Q5	Switching	10V for Amber LED
Q6	Switching	Green LED 10V control
Q7	Switching	10V for Green LED
Q9	Switching	SW5V for RTC IC
Q10	Switching	PKSOUT control
Q11	Switching	TNC MPU flash rewrite
Q12	Filter	RX 1200bps data
Q13	Filter	RX 9600bps data
Q14	Filter	RX 1200bps data
Q15	Filter	RX 1200bps data
Q16	Switching	PKTSW control
D1	Reverse current prevention	10V AVR input

Ref. No.	Use / Function	Operation / Condition / Compatibility
D2	Reverse current prevention	for backup power supply control
D3	Reverse current prevention	for backup charge control
D4	Reverse current prevention	for backup battery
D8~29	Over voltage prevention	Prevent surge voltage
D30~32	LED	Amber
D33~35	LED	Green
D36,38	LED	Amber
D39,41, D44,45	LED	Green
D46~48	LED	Amber
D49~51	LED	Green
D52~54	LED	Amber
D55~57	LED	Green
D58~60	LED	Amber
D61~63	LED	Green
D64~66	LED	Amber
D67~69	LED	Green
D70~72	LED	Amber
D73~75	LED	Green
D76~78	LED	Amber
D79~81	LED	Green
D82~84	LED	Amber
D85~87	LED	Green
D88~90	LED	Amber
D91~93	LED	Green
D94~96	LED	Amber
D97~99	LED	Green
D100~102	LED	Amber
D103~105	LED	Green
D106~108	LED	Amber
D109~111	LED	Green
D112~114	LED	Amber
D115~117	LED	Green
D118~120	LED	Amber
D121~123	LED	Green
D124~126	LED	Amber
D127~129	LED	Green
D130~132	LED	Amber
D133~135	LED	Green
D136~138	LED	Amber
D139~141	LED	Green

TM-D710A/D710E

TERMINAL FUNCTION

DISPLAY UNIT (X54-3620-00)

Pin No.	Name	I/O	Function
CN1 (for LCD)			
1	NC	-	No connection
2	VDI		VDD bypass
3	VDD		Switched 5V
4	VDIS		LCD multi-level power supply control
5	CS	I	Chip select
6	RES	I	Reset
7	A0	I	Address
8	WR	I	Write/ Read select
9	RD	I	Data bus select
10	D0	I/O	8bit MPU data bus
11	D1	I/O	8bit MPU data bus
12	D2	I/O	8bit MPU data bus
13	D3	I/O	8bit MPU data bus
14	D4	I/O	8bit MPU data bus
15	D5	I/O	8bit MPU data bus
16	D6	I/O	8bit MPU data bus
17	D7	I/O	8bit MPU data bus
18	VDI		VDD bypass
19	VDD		Switched 5V
20	NC	-	No connection
21	VSS		GND
22	NC	-	No connection
23	VDD		Switched 5V
24	NC	-	No connection
25	VDD2		Switched 5V
26	NC	-	No connection
27	VOUT	O	Output pin for step-up
28	NC	-	No connection
29	CAP1+	O	For step-up capacitor
30	CAP1-	O	For step-up capacitor
31	CAP2-	O	For step-up capacitor
32	CAP2+	O	For step-up capacitor
33	V3		LCD multi-level power supply
34	V2		LCD multi-level power supply
35	V1		LCD multi-level power supply

Pin No.	Name	I/O	Function
36	VC		LCD multi-level power supply
37	MV1		LCD multi-level power supply
38	MV2		LCD multi-level power supply
39	VSS	-	GND
40	SVD2	O	NC (Thermal sensor)
CN2			
1	GND	-	GND
2	SW5V	O	Switched 5V
3	KEY12	I	Volume key signal (Band A)
4	VOL_A	I	AF volume voltage (Band A)
5	SQL_A	I	SQL volume voltage (Band A)
CN3			
1	GND	-	GND
2	SW5V	O	Switched 5V
3	KEY13	I	Volume key signal (Band B)
4	VOL_B	I	AF volume voltage (Band B)
5	SQL_B	I	SQL volume voltage (Band B)
CN4			
1	PRI	I	TNC data input
2	10V	I	+10V
3	GND	-	GND
4	TXD	I	Serial data input
5	PKS	O	Data standby control signal output
6	PKD	O	TNC data output
7	RXD	O	Serial data output
8	SQC	I	Squelch control signal input
CN5 (for backup battery)			
1	+		Battery +
2	GND	-	GND
CN11			
1	GND	-	GND
2	SW5V	I	Switched 5V
3	KEY12	O	Volume key signal (Band A)
4	VOL_A	O	AF volume voltage (Band A)
5	SQL_A	O	SQL volume voltage (Band A)
CN12			
1	GND	-	GND

TERMINAL FUNCTION

Pin No.	Name	I/O	Function
2	SW5V	I	Switched 5V
3	KEY13	O	Volume key signal (Band B)
4	VOL_B	O	AF volume voltage (Band B)
5	SQL_B	O	SQL volume voltage (Band B)
CN13			
1	PRI	O	TNC data output
2	10V	O	+10V
3	GND	-	GND
4	TXD	O	Serial data output
5	PKS	I	Data standby control signal input
6	PKD	I	TNC data input
7	RXD	I	Serial data input
8	SQC	O	Squelch control signal output
J1 (to TX-RX (CONTROL) unit D/6)			
1	SQC	I	Squelch control signal input
2	RXD	O	Serial data output
3	PKD	O	TNC data output
4	PKS	O	Data standby control signal output

Pin No.	Name	I/O	Function
5	TXD	I	Serial data input
6	GND	-	GND
7	10V	I	+10V
8	PRI	I	TNC data input
J2 (COM terminal)			
1	RTS	O	Request to send
2	CTS	I	Clear to send
3	TXD	O	Transmit data
4	GND	-	GND
5	RXD	I	Receive data
6	NC	-	No connection
7	NC	-	No connection
8	NC	-	No connection
J3 (GPS jack)			
1	GND	-	GND
2	TXD	O	GPS receiver command output
3	RXD	I	GPS measurement data input

TM-D710A/D710E

PARTS LIST

* New Parts. Δ indicates safety critical components.

Parts without **Parts No.** are not supplied.

Les articles non mentionnés dans le **Parts No.** ne sont pas fournis.

Teile ohne **Parts No.** werden nicht geliefert.

L : Scandinavia

K : USA

P : Canada

Y : PX (Far East, Hawaii)

T : England

E : Europe

Y : AAFES (Europe)

X : Australia

M : Other Areas

TM-D710A/D710E (Y51-513X-XX) DISPLAY UNIT (X54-3620-00)

Ref. No.	Address	New parts	Parts No.	Description	Destination
TM-D710A/D710E					
1	1B	*	A01-2206-22	METALLIC CABINET	
2	3B	*	A62-1157-01	PANEL (MAIN UNIT)	
3	3A	*	A62-1159-01	PANEL (DISPLAY)	
4	1A	*	A82-0072-11	REAR PANEL (DISPLAY)	
6	3A	*	B10-2782-12	FRONT GLASS (DISPLAY)	
7	3A	*	B11-1856-03	ILLUMINATION GUIDE (ENC)	
8	2A	*	B11-1858-03	ILLUMINATION GUIDE (LCD)	
9	2A	*	B38-0926-05	LCD (DISPLAY)	
10	3A	*	B43-1611-04	BADGE (DISPLAY)	
11	1C	*	B62-1986-00	INSTRUCTION MANUAL (ENG)	
12	1C	*	B62-1987-00	INSTRUCTION MANUAL (SPA/FRA)	K,E
13	1C	*	B62-1989-00	INSTRUCTION MANUAL (ITA/GER/DUT)	E
14	1C	*	B62-1992-00	INSTRUCTION MANUAL (CHINESE)	M4
16	3B		E04-0167-15	RF COAXIAL RECEPTACLE (M)	K,M4
17	3B		E04-0170-15	RF COAXIAL RECEPTACLE (N)	E
18	3C		E30-3400-05	CORD WITH PLUG (GPS) ACCESSORY	
19	2C		E30-3452-05	DC CORD ACCESSORY	E
20	2B		E30-3453-05	DC CORD (MAIN UNIT)	E
21	2C		E30-7628-05	DC CORD ACCESSORY	K,M4
22	1A,2C	*	E30-7639-05	MODULAR CABLE (4m) ACCESSORY	
23	2B		E30-7642-05	DC CORD (MAIN UNIT)	K,M4
24	1B		E37-1291-05	LEAD WIRE WITH CONNECTOR (SP)	
27	3B		F07-1916-05	COVER (FANMOTOR)	
28	3B		F09-0489-05	FANMOTOR	
29	2B		F10-3072-03	SHIELDING COVER (POWER MODULE)	
30	2A		F20-1186-14	INSULATING SHEET (DISPLAY)	
31	2C		F51-0079-05	FUSE (6X30,15A) ACCESSORY	K,M4
32	2C		F52-0024-05	FUSE (BLADE,15A) ACCESSORY	E
34	3A		G09-0405-05	KNOB SPRING (ENC)	
35	2A	*	G10-1374-04	FIBROUS SHEET (MODULAR JACK)	
36	2C	*	G11-4228-04	SHEET (BRACKET) ACCESSORY	
37	3A	*	G11-4430-03	SHEET (FRONT GLASS)	
38	2A	*	G11-4431-04	SHEET (DISPLAY)	
39	3C	*	G11-4438-04	SHEET (STAND) ACCESSORY	K,E
40	2A	*	G11-4445-04	SHEET (DISPLAY)	
41	1B		G13-2153-04	CONDUCTIVE CUSHION (SP COVER)	
42	3A	*	G13-2221-04	CUSHION (DISPLAY)	
43	2A	*	G13-2222-04	CUSHION (3KEY)	
44	2A	*	G13-2229-04	CUSHION (7KEY)	
45	2A	*	G13-2230-04	CUSHION (MODULAR JACK)	
46	3C	*	G13-2233-04	CUSHION (BRACKET) ACCESSORY	
47	3B	*	G13-2239-04	CUSHION (MAIN UNIT MIC MODULAR)	
48	3C		J09-0409-03	STAND ACCESSORY	K,E
49	2C		J19-1584-15	HOLDER (MICROPHONE) ACCESSORY	
50	1B		J19-5500-04	HOLDER (SP)	
51	2A	*	J21-8580-03	MOUNTING HARDWARE (LCD)	
52	1D		J29-0628-33	BRACKET (MAIN UNIT) ACCESSORY	
53	3C		J29-0663-13	BRACKET (DISPLAY) ACCESSORY	
54	2C		J29-0707-03	BRACKET (DISPLAY) ACCESSORY	
55	2B		J82-0113-05	FPC (TXRX-CONT)	
57	3A		K29-9377-03	KNOB (VOL)	
58	3A		K29-9380-03	KNOB (SQL)	

Ref. No.	Address	New parts	Parts No.	Description	Destination
59	3A	*	K29-9409-03	KNOB (ENC)	
60	2A	*	K29-9410-02	BUTTON KNOB (3KEY-L)	
61	3B	*	K29-9411-02	BUTTON KNOB (3KEY-R)	
62	3A	*	K29-9412-02	BUTTON KNOB (7KEY)	
64	2C		L79-1417-05	LINE FILTER ACCESSORY	
A	3B		N09-6548-05	SEMS SCREW (FANMOTOR)	
B	1A,1B	*	N09-6555-05	TAPTITE SCREW (REAR PANEL)	
C	3A		N14-0830-14	CIRCULAR NUT (VOL)	
D	3A	*	N14-0845-04	CIRCULAR NUT (ENC)	
E	1B		N33-2606-43	OVAL HEAD MACHINE SCREW (CASE)	
F	2B		N67-3008-48	PAN HEAD SEMS SCREW (PM,AMP,AVR)	
G	2A		N80-2008-48	PAN HEAD TAPTITE SCREW (DISPLAY PCB)	
H	2B,3B		N87-2606-48	BRAZIER HEAD TAPTITE SCREW (PCB,ANT)	
J	3A,3B		N89-2606-43	BINDING HEAD TAPTITE SCREW (SUB PANEL)	
66	2C		N99-2055-05	SCREW SET ACCESSORY	
68	1B		T07-0368-15	SPEAKER	
69	2C	*	T91-0657-25	MICROPHONE ACCESSORY	
70	1C	*	T93-0131-05	CD-ROM (I/M) ACCESSORY	
72	2A		W09-0971-05	LITHIUM CELL (DISPLAY)	
DISPLAY UNIT (X54-3620-00)					
D30-32			B30-2290-05	LED (G/Y)	
D33-35			B30-2293-05	LED (YG)	
D36			B30-2281-05	LED (Y)	
D38			B30-2281-05	LED (Y)	
D39			B30-2293-05	LED (YG)	
D41			B30-2293-05	LED (YG)	
D42,43			B30-2290-05	LED (G/Y)	
D44,45			B30-2293-05	LED (YG)	
D46-48			B30-2290-05	LED (G/Y)	
D49-51			B30-2293-05	LED (YG)	
D52-54			B30-2290-05	LED (G/Y)	
D55-57			B30-2293-05	LED (YG)	
D58-60			B30-2290-05	LED (G/Y)	
D61-63			B30-2293-05	LED (YG)	
D64-66			B30-2290-05	LED (G/Y)	
D67-69			B30-2293-05	LED (YG)	
D70-72			B30-2290-05	LED (G/Y)	
D73-75			B30-2293-05	LED (YG)	
D76-78			B30-2290-05	LED (G/Y)	
D79-81			B30-2293-05	LED (YG)	
D82-84			B30-2290-05	LED (G/Y)	
D85-87			B30-2293-05	LED (YG)	
D88-90			B30-2290-05	LED (G/Y)	
D91-93			B30-2293-05	LED (YG)	
D94-96			B30-2290-05	LED (G/Y)	
D97-99			B30-2293-05	LED (YG)	
D100-102			B30-2290-05	LED (G/Y)	
D103-105			B30-2293-05	LED (YG)	
D106-108			B30-2290-05	LED (G/Y)	
D109-111			B30-2293-05	LED (YG)	
D112-114			B30-2290-05	LED (G/Y)	

PARTS LIST

DISPLAY UNIT (X54-3620-00)

Ref. No.	Address	New parts	Parts No.	Description	Desti-nation	Ref. No.	Address	New parts	Parts No.	Description	Desti-nation
D115-117			B30-2293-05	LED (YG)		C99			CK73GB1E105K	CHIP C	1.0UF K
D118-120			B30-2290-05	LED (G/Y)		C100			CC73HCH1H101J	CHIP C	100PF J
D121-123			B30-2293-05	LED (YG)		C101			CK73HB1A104K	CHIP C	0.10UF K
D124-126			B30-2290-05	LED (G/Y)		C102			CK73HB1H102K	CHIP C	1000PF K
D127-129			B30-2293-05	LED (YG)		C103,104			CK73HB1A104K	CHIP C	0.10UF K
D130-132			B30-2290-05	LED (G/Y)		C105			CK73HB1H102K	CHIP C	1000PF K
D133-135			B30-2293-05	LED (YG)		C106			CK73HB1A104K	CHIP C	0.10UF K
D136-138			B30-2290-05	LED (G/Y)		C107,108			CC73GCH1H090B	CHIP C	9.0PF B
D139-141			B30-2293-05	LED (YG)		C109			CK73HB1H102K	CHIP C	1000PF K
C1			CE32CL1HR47M	CHIP EL	0.47UF 50WV	C110			CK73HB1A104K	CHIP C	0.10UF K
C2			CE32BF1E101M	CHIP EL	100UF 25WV	C112-114			CK73HB1A104K	CHIP C	0.10UF K
C3-5			CE32CL1C100M	CHIP EL	10UF 16WV	C115			CK73HB1H102K	CHIP C	1000PF K
C6			CE32BM1C101M	CHIP EL	100UF 16WV	C116,117			CK73HB1A104K	CHIP C	0.10UF K
C7			CE32CL1C100M	CHIP EL	10UF 16WV	C118			CK73HB1H102K	CHIP C	1000PF K
C8			CK73GB1H122K	CHIP C	1200PF K	C119,120			CK73HB1A104K	CHIP C	0.10UF K
C11			CK73GB1H471K	CHIP C	470PF K	C121			CK73GB1C683K	CHIP C	0.068UF K
C12,13			CK73GB1E104K	CHIP C	0.10UF K	C122,123			CK73GB1H152K	CHIP C	1500PF K
C14			CK73GB1E105K	CHIP C	1.0UF K	C124,125			CK73HB1A104K	CHIP C	0.10UF K
C15			CK73HB1A104K	CHIP C	0.10UF K	C126,127			CC73GCH1H040C	CHIP C	4.0PF C
C16			CC73GCH1H101J	CHIP C	100PF J	C128			CK73HB1A104K	CHIP C	0.10UF K
C17,18			CK73HB1A104K	CHIP C	0.10UF K	C129,130			CK73GB1E105K	CHIP C	1.0UF K
C19			CK73GB1H471K	CHIP C	470PF K	C131			CC73HCH1H101J	CHIP C	100PF J
C20-22			CC73GCH1H101J	CHIP C	100PF J	C132			CK73HB1E472K	CHIP C	4700PF K
C23			CK73HB1H102K	CHIP C	1000PF K	C133			CK73HB1H471K	CHIP C	470PF K
C24,25			CK73HB1A104K	CHIP C	0.10UF K	C134			CK73HB1H102K	CHIP C	1000PF K
C26			CK73HB1H102K	CHIP C	1000PF K	C135			CK73GB1H682K	CHIP C	6800PF K
C27,28			CC73GCH1H220J	CHIP C	22PF J	C136			CK73GB1H103K	CHIP C	0.010UF K
C29			CK73HB1H471K	CHIP C	470PF K	C137			CK73GB1H222K	CHIP C	2200PF K
C30-32			CK73HB1A104K	CHIP C	0.10UF K	C138			CK73GB1H102K	CHIP C	1000PF K
C33			CK73HB1H102K	CHIP C	1000PF K	C139			CK73GB1H221K	CHIP C	220PF K
C34			CK73HB1A104K	CHIP C	0.10UF K	C140			CK73HB1A104K	CHIP C	0.10UF K
C35			CK73HB1H471K	CHIP C	470PF K	C141			CK73HB1E103K	CHIP C	0.010UF K
C36			CK73HB1A104K	CHIP C	0.10UF K	C142			CK73HB1H102K	CHIP C	1000PF K
C37			CK73GB1A105K	CHIP C	1.0UF K	C143			CK73GB1E105K	CHIP C	1.0UF K
C38			CK73HB1A104K	CHIP C	0.10UF K	C144,145			CK73GB1C223K	CHIP C	0.022UF K
C39,40			CC73GCH1H101J	CHIP C	100PF J	C146			CK73GB1H682K	CHIP C	6800PF K
C41-43			CK73HB1A104K	CHIP C	0.10UF K	C147			CK73GB1C223K	CHIP C	0.022UF K
C44			CK73HB1H471K	CHIP C	470PF K	C148			CK73GB1H682K	CHIP C	6800PF K
C45			CK73GB1A105K	CHIP C	1.0UF K	C149			CK73GB1E103K	CHIP C	0.010UF K
C46-49			CK73GB1C104K	CHIP C	0.10UF K	C150			CK73HB1H471K	CHIP C	470PF K
C50-53			CC73GCH1H101J	CHIP C	100PF J	C151			CK73HB1A104K	CHIP C	0.10UF K
C54			CK73HB1A104K	CHIP C	0.10UF K	CN1	*	E40-6759-05	FLAT CABLE CONNECTOR		
C55			CC73GCH1H820J	CHIP C	82PF J	CN2,3		E40-6708-05	PIN ASSY		
C56			CK73HB1A104K	CHIP C	0.10UF K	CN4	*	E40-6765-05	PIN ASSY		
C57			CK73FB1A475K	CHIP C	4.7UF K	CN11,12		E40-6710-05	PIN ASSY		
C58			CK73GB1C104K	CHIP C	0.10UF K	CN13	*	E40-6766-05	PIN ASSY		
C59-61			CK73HB1A104K	CHIP C	0.10UF K	J1		E58-0522-05	MODULAR JACK		
C62			CK73GB1H104K	CHIP C	0.10UF K	J2	*	E56-0419-05	DIN SOCKET		
C63			CK73GB1E105K	CHIP C	1.0UF K	J3		E11-0709-05	2.5D PHONE JACK		
C64			CK73GB1H104K	CHIP C	0.10UF K	CN5		J19-5386-05	HOLDER (LITHIUM CELL)		
C65			CK73GB1E105K	CHIP C	1.0UF K	L1-3		L92-0138-05	CHIP FERRITE		
C66			CK73GB1H104K	CHIP C	0.10UF K	L4		L33-1990-05	CHOKE COIL		
C67-79			CK73GB1E105K	CHIP C	1.0UF K	L11		L41-4795-33	SMALL FIXED INDUCTOR (4.7UH)		
C80			CK73HB1A104K	CHIP C	0.10UF K	L12-18		L92-0140-05	CHIP FERRITE		
C81			CK73HB1H471K	CHIP C	470PF K	X1		L77-1950-05	CRYSTAL RESONATOR (11.0592MHZ)		
C82			CK73HB1E472K	CHIP C	4700PF K	X2		L77-1802-05	CRYSTAL RESONATOR (32768HZ)		
C83			CK73HB1H471K	CHIP C	470PF K	X3	*	L77-3031-05	CRYSTAL RESONATOR (15.9744MHZ)		
C84			CK73HB1E472K	CHIP C	4700PF K						
C85-98			CK73HB1H471K	CHIP C	470PF K						

PARTS LIST

DISPLAY UNIT (X54-3620-00)

Ref. No.	Address	New parts	Parts No.	Description	Destination	Ref. No.	Address	New parts	Parts No.	Description	Destination
CP1			RK74HB1J102J	CHIP-COM 1.0K J 1/16W		R115			RK73GH2A392D	CHIP R 3.9K D 1/10W	
CP2			RK74HB1J473J	CHIP-COM 47K J 1/16W		R116			RK73GB2A562J	CHIP R 5.6K J 1/10W	
CP3			RK75HA1J473J	CHIP-COM 47K J 1/16W		R117,118			RK73HB1J154J	CHIP R 150K J 1/16W	
CP4			RK75HA1J103J	CHIP-COM 10K J 1/16W		R119			RK73HB1J473J	CHIP R 47K J 1/16W	
CP5,6			RK74HB1J102J	CHIP-COM 1.0K J 1/16W		R120			RK73HB1J154J	CHIP R 150K J 1/16W	
CP7			RK74HB1J473J	CHIP-COM 47K J 1/16W		R121			RK73HB1J473J	CHIP R 47K J 1/16W	
CP10-13			RK74HB1J473J	CHIP-COM 47K J 1/16W		R122			RK73HB1J563J	CHIP R 56K J 1/16W	
R1,2			RK73HB1J333J	CHIP R 33K J 1/16W		R123			RK73HB1J104J	CHIP R 100K J 1/16W	
R3,4			RK73HB1J473J	CHIP R 47K J 1/16W		R124			RK73HB1J154J	CHIP R 150K J 1/16W	
R5			RK73HB1J334J	CHIP R 330K J 1/16W		R125-127			RK73HB1J103J	CHIP R 10K J 1/16W	
R6,7			RK73GH2A393D	CHIP R 39K D 1/10W		R128			RK73HB1J332J	CHIP R 3.3K J 1/16W	
R8			RK73HB1J394J	CHIP R 390K J 1/16W		R129			RK73HB1J823J	CHIP R 82K J 1/16W	
R9			RK73HB1J102J	CHIP R 1.0K J 1/16W		R130			RK73HB1J393J	CHIP R 39K J 1/16W	
R10			RK73HB1J000J	CHIP R 0.0 J 1/16W		R131			RK73HB1J332J	CHIP R 3.3K J 1/16W	
R11			RK73HB1J103J	CHIP R 10K J 1/16W		R132			RK73HB1J103J	CHIP R 10K J 1/16W	
R12			RK73HB1J333J	CHIP R 33K J 1/16W		R133			RK73HB1J472J	CHIP R 4.7K J 1/16W	
R14-16			RK73HB1J103J	CHIP R 10K J 1/16W		R134			RK73HB1J104J	CHIP R 100K J 1/16W	
R17			RK73HB1J101J	CHIP R 100 J 1/16W		R135-138			RK73HB1J103J	CHIP R 10K J 1/16W	
R18,19			RK73HB1J102J	CHIP R 1.0K J 1/16W		R139-141			RK73HB1J123J	CHIP R 12K J 1/16W	
R20			RK73HB1J101J	CHIP R 100 J 1/16W		R142			RK73HB1J222J	CHIP R 2.2K J 1/16W	
R21-26			RK73HB1J102J	CHIP R 1.0K J 1/16W		R143,144			RK73HB1J123J	CHIP R 12K J 1/16W	
R27,28			RK73HB1J103J	CHIP R 10K J 1/16W		R145			RK73HB1J332J	CHIP R 3.3K J 1/16W	
R29			RK73HB1J473J	CHIP R 47K J 1/16W		R146			RK73HB1J103J	CHIP R 10K J 1/16W	
R30			RK73HB1J102J	CHIP R 1.0K J 1/16W		R147,148			RK73HB1J223J	CHIP R 22K J 1/16W	
R31-34			RK73GB2A101J	CHIP R 100 J 1/10W		R149			RK73HB1J103J	CHIP R 10K J 1/16W	
R35			RK73GB2A000J	CHIP R 0.0 J 1/10W		R150			RK73HB1J272J	CHIP R 2.7K J 1/16W	
R36-39			RK73HB1J102J	CHIP R 1.0K J 1/16W		R151			RK73HB1J273J	CHIP R 27K J 1/16W	
R40,41			RK73HB1J473J	CHIP R 47K J 1/16W		R152			RK73HB1J272J	CHIP R 2.7K J 1/16W	
R42			RK73HB1J102J	CHIP R 1.0K J 1/16W		R153			RK73HB1J273J	CHIP R 27K J 1/16W	
R43			RK73HB1J473J	CHIP R 47K J 1/16W		R154			RK73HB1J223J	CHIP R 22K J 1/16W	
R44			RK73HB1J102J	CHIP R 1.0K J 1/16W		R155			RK73HB1J273J	CHIP R 27K J 1/16W	
R45			RK73HB1J473J	CHIP R 47K J 1/16W		R160,161			RK73HB1J102J	CHIP R 1.0K J 1/16W	
R46,47			RK73HB1J102J	CHIP R 1.0K J 1/16W		R162			RK73HB1J273J	CHIP R 27K J 1/16W	
R48,49			RK73GB2A101J	CHIP R 100 J 1/10W		R163			RK73HB1J104J	CHIP R 100K J 1/16W	
R50,51			RK73HB1J102J	CHIP R 1.0K J 1/16W		R164			RK73HB1J103J	CHIP R 10K J 1/16W	
R52			RK73HB1J222J	CHIP R 2.2K J 1/16W		R165			RK73HB1J473J	CHIP R 47K J 1/16W	
R53			RK73HB1J102J	CHIP R 1.0K J 1/16W		R166-173			RK73GB2A271J	CHIP R 270 J 1/10W	
R54			RK73HB1J473J	CHIP R 47K J 1/16W		R175,176			RK73HB1J473J	CHIP R 47K J 1/16W	
R55			RK73HB1J122J	CHIP R 1.2K J 1/16W		R179			RK73HB1J473J	CHIP R 47K J 1/16W	
R56			RK73HB1J821J	CHIP R 820 J 1/16W		R180			RK73HB1J472J	CHIP R 4.7K J 1/16W	
R57			RK73HB1J000J	CHIP R 0.0 J 1/16W		R273			RK73FB2B121J	CHIP R 120 J 1/8W	
R58,59			RK73EB2E102J	CHIP R 1.0K J 1/4W		R275			RK73HB1J154J	CHIP R 150K J 1/16W	
R60			RK73FB2B102J	CHIP R 1.0K J 1/8W		VR1,2			R31-0629-15	VARIABLE RESISTOR	
R61			RK73HB1J000J	CHIP R 0.0 J 1/16W		S11-23			S70-0439-15	TACT SWITCH	
R62,63			RK73EB2E102J	CHIP R 1.0K J 1/4W		D1			1SR154-400	DIODE	
R64			RK73FB2B102J	CHIP R 1.0K J 1/8W		D2,3			1SS388F	DIODE	
R65,66			RK73GB2A271J	CHIP R 270 J 1/10W		D4			1SS400	DIODE	
R69,70			RK73FB2B121J	CHIP R 120 J 1/8W		D8-29			DA221	DIODE	
R71,72			RK73FB2B471J	CHIP R 470 J 1/8W		IC1	*		30626FHPGKBXC	MICROPROCESSOR IC	
R74			RK73FB2B121J	CHIP R 120 J 1/8W		IC2			AT25256A10TU27	ROM IC	
R75,76			RK73FB2B471J	CHIP R 470 J 1/8W		IC3			BD4840FVE	MOS-IC	
R77-100			RK73GB2A271J	CHIP R 270 J 1/10W		IC4,5			TC4S81F-F	MOS-IC	
R101			RK73HB1J103J	CHIP R 10K J 1/16W		IC6			TA4805BF	MOS-IC	
R102,103			RK73HB1J000J	CHIP R 0.0 J 1/16W		IC7			ADM202EARUZ	MOS-IC	
R104-107			RK73HB1J103J	CHIP R 10K J 1/16W		IC8			BU2099FV	MOS-IC	
R108,109			RK73HB1J000J	CHIP R 0.0 J 1/16W		IC10			TA75W01FUF	MOS-IC	
R111			RK73HB1J101J	CHIP R 100 J 1/16W		IC11	*		3048BTE25KBYB	MICROPROCESSOR IC	
R112			RK73HB1J103J	CHIP R 10K J 1/16W		IC12			TGT0210Q	MOS-IC	
R113			RK73HB1J102J	CHIP R 1.0K J 1/16W		IC13	*		R1LP0408CSB5S	SRAM IC	
R114			RK73HB1J334J	CHIP R 330K J 1/16W							

PARTS LIST

DISPLAY UNIT (X54-3620-00)
TX-RX UNIT (X57-731X-XX)

Ref. No.	Address	New parts	Parts No.	Description	Desti-nation	Ref. No.	Address	New parts	Parts No.	Description	Desti-nation
IC14			BD4840FVE	MOS-IC		C35			CC73HCH1H150G	CHIP C	15PF G
IC15			TC7S00FU-F	MOS-IC		C36-39			CK73HB1H471K	CHIP C	470PF K
IC16			TC7W74FU-F	MOS-IC		C40			CC73HCH1H040B	CHIP C	4.0PF B
IC17			TA75W393FU-F	MOS-IC		C41			CC73HCH1H1R5B	CHIP C	1.5PF B
IC18			TA75S393F-F	MOS-IC		C42-44			CK73HB1H471K	CHIP C	470PF K
IC19			TC7W66FK-F	MOS-IC		C45			CC73HCH1H150G	CHIP C	15PF G
IC20			M62364FP-F	MOS-IC		C46			CC73HCH1H010B	CHIP C	1.0PF B
IC21			TC4S81F-F	MOS-IC		C47			CC73HCH1H150G	CHIP C	15PF G
IC22			TC75S51F-F	MOS-IC		C49,50			CK73HB1H471K	CHIP C	470PF K
IC23		*	ADM101EARMZ	MOS-IC		C51			CC73HCH1H030B	CHIP C	3.0PF B
IC24			BD4840FVE	MOS-IC		C52			CC73HCH1H150G	CHIP C	15PF G
IC25			RV5C386A	MOS-IC		C53			CK73HB1H471K	CHIP C	470PF K
Q1,2			DTA123JUA	DIGITAL TRANSISTOR		C54			CC73HCH1H270G	CHIP C	27PF G
Q3			2SA1162-F(Y)	TRANSISTOR		C55			CC73HCH1H030B	CHIP C	3.0PF B
Q4			DTC144EUA	DIGITAL TRANSISTOR		C56,57			CK73HB1H102K	CHIP C	1000PF K
Q5			CPH6122	TRANSISTOR		C58			CC73HCH1H070B	CHIP C	7.0PF B
Q6			DTC144EUA	DIGITAL TRANSISTOR		C59			CC73HCH1H020B	CHIP C	2.0PF B
Q7			CPH6122	TRANSISTOR		C60			CK73HB1H102K	CHIP C	1000PF K
Q9			DTA123JUA	DIGITAL TRANSISTOR		C61,62			CK73HB1H471K	CHIP C	470PF K
Q10			DTC143EKA	DIGITAL TRANSISTOR		C63			CC73HCH1H040B	CHIP C	4.0PF B
Q11			DTC144EUA	DIGITAL TRANSISTOR		C64,65			CC73HCH1H100B	CHIP C	10PF B
Q12,13			2SC4617(R)	TRANSISTOR		C66			CK73HB1H471K	CHIP C	470PF K
Q14			2SA1774(R)	TRANSISTOR		C67			CK73HB1H102K	CHIP C	1000PF K
Q15			2SC4617(R)	TRANSISTOR		C68			CK73HB1E103K	CHIP C	0.010UF K
Q16			2SK1824-A	FET		C69,70			CK73GB1H104K	CHIP C	0.10UF K
S1			W02-1978-05	ENCODER		C71			CC73HCH1H470J	CHIP C	47PF J
TX-RX UNIT (X57-731X-XX) 0-11: K 0-21: M4 2-71: E						C72			CK73HB1H471K	CHIP C	470PF K
C1			CK73HB1H471K	CHIP C	470PF K	C74			CK73HB1H471K	CHIP C	470PF K
C2			CK73HB1H102K	CHIP C	1000PF K	C75			CK73GB1H104K	CHIP C	0.10UF K
C3			CK73HB1E103K	CHIP C	0.010UF K	C76,77			CK73HB1H102K	CHIP C	1000PF K
C4,5			CK73GB1H104K	CHIP C	0.10UF K	C78			CS77CB21A220M	CHIP TNTL	22UF 10WV
C6			CC73HCH1H470J	CHIP C	47PF J	C79			CK73HB1E103K	CHIP C	0.010UF K
C7			CK73HB1H471K	CHIP C	470PF K	C80			CK73HB1H102K	CHIP C	1000PF K
C9			CK73HB1H471K	CHIP C	470PF K	C81,82			CK73HB1E103K	CHIP C	0.010UF K
C10			CK73GB1H104K	CHIP C	0.10UF K	C83			CK73GB1C473K	CHIP C	0.047UF K
C11			CK73HB1H102K	CHIP C	1000PF K	C84			CK73HB1H102K	CHIP C	1000PF K
C12			CS77CB21A220M	CHIP TNTL	22UF 10WV	C85			CS77AA1VR47M	CHIP TNTL	0.47UF 35WV
C13			CK73HB1E103K	CHIP C	0.010UF K	C86			CS77AA1A100M	CHIP TNTL	10UF 10WV
C14			CK73HB1H102K	CHIP C	1000PF K	C87,88			CK73HB1H102K	CHIP C	1000PF K
C15,16			CK73HB1E103K	CHIP C	0.010UF K	C89			CS77CA1VR22M	CHIP TNTL	0.22UF 35WV
C17			CK73GB1C473K	CHIP C	0.047UF K	C90			CS77CB21A220M	CHIP TNTL	22UF 10WV
C18			CS77AA1VR47M	CHIP TNTL	0.47UF 35WV	C91			CC73HCH1H040B	CHIP C	4.0PF B
C19			CK73HB1H102K	CHIP C	1000PF K	C92			CK73HB1H471K	CHIP C	470PF K
C20			CS77AA1A100M	CHIP TNTL	10UF 10WV	C93			CC73HCH1H100B	CHIP C	10PF B
C21,22			CK73HB1H102K	CHIP C	1000PF K	C94			CK73HB1E103K	CHIP C	0.010UF K
C23			CS77CA1VR22M	CHIP TNTL	0.22UF 35WV	C95			CK73GB1A105K	CHIP C	1.0UF K
C24			CS77CB21A220M	CHIP TNTL	22UF 10WV	C96			CC73HCH1H040B	CHIP C	4.0PF B
C25			CK73HB1H102K	CHIP C	1000PF K	C97			CC73HCH1H270G	CHIP C	27PF G
C26			CK73HB1H471K	CHIP C	470PF K	C98			CK73HB1E103K	CHIP C	0.010UF K
C27			CC73HCH1H100B	CHIP C	10PF B	C99			CC73HCH1H101J	CHIP C	100PF J
C28			CK73HB1E103K	CHIP C	0.010UF K	C100			CC73HCH1H120G	CHIP C	12PF G
C29			CK73GB1A105K	CHIP C	1.0UF K	C101			CC73HCH1H150G	CHIP C	15PF G
C30			CC73HCH1H040B	CHIP C	4.0PF B	C102-105			CK73HB1H471K	CHIP C	470PF K
C31			CC73HCH1H270G	CHIP C	27PF G	C106			CC73HCH1H040B	CHIP C	4.0PF B
C32			CK73HB1E103K	CHIP C	0.010UF K	C107			CC73HCH1H1R5B	CHIP C	1.5PF B
C33			CC73HCH1H101J	CHIP C	100PF J	C108-110			CK73HB1H471K	CHIP C	470PF K
C34			CC73HCH1H120G	CHIP C	12PF G	C111			CC73HCH1H150G	CHIP C	15PF G
						C112			CC73HCH1H010B	CHIP C	1.0PF B
						C113-117			CK73HB1H471K	CHIP C	470PF K
						C119,120			CK73HB1H471K	CHIP C	470PF K

PARTS LIST

TX-RX UNIT (X57-731X-XX)

Ref. No.	Address	New parts	Parts No.	Description	Destination	Ref. No.	Address	New parts	Parts No.	Description	Destination
C121,122			CK73HB1H102K	CHIP C 1000PF K		C197			C93-0562-05	CHIP C 15PF J	
C123			CC73HCH1H070B	CHIP C 7.0PF B		C198			C93-0553-05	CHIP C 3.0PF C	
C124			CC73HCH1H020B	CHIP C 2.0PF B		C199			C93-0552-05	CHIP C 2.0PF C	
C125			CK73HB1H102K	CHIP C 1000PF K		C200			CC73GCH1HR75B	CHIP C 0.75PF B	
C126			CK73GB1E105K	CHIP C 1.0UF K		C201			C93-0553-05	CHIP C 3.0PF C	
C127,128			CK73HB1H471K	CHIP C 470PF K		C202-207			CK73GB1H102K	CHIP C 1000PF K	
C129,130			CC73HCH1H100B	CHIP C 10PF B		C208			CK73HB1E103K	CHIP C 0.010UF K	
C131-133			CK73HB1H102K	CHIP C 1000PF K		C209			CK73HB1H102K	CHIP C 1000PF K	
C134			CK73GB1H102K	CHIP C 1000PF K		C210			CK73HB1C223K	CHIP C 0.022UF K	
C135			CK73HB1H471K	CHIP C 470PF K		C211			CK73HB1E103K	CHIP C 0.010UF K	
C136			CK73FB1A475K	CHIP C 4.7UF K		C212			CK73HB1C223K	CHIP C 0.022UF K	
C137-139			CK73GB1H471K	CHIP C 470PF K		C213-215			CK73HB1H102K	CHIP C 1000PF K	
C141			CK73GB1H471K	CHIP C 470PF K		C216			CK73GB1H471K	CHIP C 470PF K	
C142			CK73GB1H104K	CHIP C 0.10UF K		C217			CK73GB1H104K	CHIP C 0.10UF K	
C143			CK73GB1H471K	CHIP C 470PF K		C218,219			CK73HB1H102K	CHIP C 1000PF K	
C144			C93-0562-05	CHIP C 15PF J		C220-222			CK73GB1H471K	CHIP C 470PF K	
C145			CK73GB1H103K	CHIP C 0.010UF K		C223			CK73HB1H471K	CHIP C 470PF K	
C146			CK73EB1E225K	CHIP C 2.2UF C		C224			CK73HB1A104K	CHIP C 0.10UF K	
C149			C93-0554-05	CHIP C 4.0PF C		C225			C93-0555-05	CHIP C 5.0PF C	
C150			CK73GB1H102K	CHIP C 1000PF K		C226			C93-0553-05	CHIP C 3.0PF C	
C151			C93-0562-05	CHIP C 15PF J		C227			CC73GCH1H3R5B	CHIP C 3.5PF B	
C152			CK73GB1H103K	CHIP C 0.010UF K		C228			CC73HCH1H030B	CHIP C 3.0PF B	
C153			CK73HB1H102K	CHIP C 1000PF K		C229			CC73HCH1H070B	CHIP C 7.0PF B	
C154,155			CK73HB1H471K	CHIP C 470PF K		C230			CK73HB1H102K	CHIP C 1000PF K	
C156			CC73HCH1H150G	CHIP C 15PF G		C231,232			CC73HCH1H040B	CHIP C 4.0PF B	
C157-160			CC73HCH1H050B	CHIP C 5.0PF B		C233			CK73HB1H102K	CHIP C 1000PF K	
C161,162			CK73HB1H471K	CHIP C 470PF K		C234			CC73HCH1H110G	CHIP C 11PF G	
C163			CK73HB1H102K	CHIP C 1000PF K		C235			CK73HB1A104K	CHIP C 0.10UF K	
C164			CK73HB1H471K	CHIP C 470PF K		C236			CK73HB1H102K	CHIP C 1000PF K	
C165			CC73HCH1H150G	CHIP C 15PF G		C237			CK73HB1A104K	CHIP C 0.10UF K	
C166			CK73HB1H471K	CHIP C 470PF K		C239-245			CK73HB1H102K	CHIP C 1000PF K	
C167			CK73GB1H471K	CHIP C 470PF K		C246			CC73HCH1H020B	CHIP C 2.0PF B	
C168			CK73HB1H471K	CHIP C 470PF K		C247-252			CK73HB1H102K	CHIP C 1000PF K	
C169			CK73FB1A475K	CHIP C 4.7UF K		C253,254			CK73HB1H471K	CHIP C 470PF K	
C170			CK73GB1H471K	CHIP C 470PF K		C255-257			CK73HB1H102K	CHIP C 1000PF K	
C171			CC73GCH1H100D	CHIP C 10PF D		C259-261			CK73HB1H102K	CHIP C 1000PF K	
C172			CK73GB1H471K	CHIP C 470PF K		C262			CC73HCH1H020B	CHIP C 2.0PF B	
C173			C93-0553-05	CHIP C 3.0PF C		C263-269			CK73HB1H102K	CHIP C 1000PF K	
C174			CK73GB1H471K	CHIP C 470PF K		C270			CC73HCH1H101J	CHIP C 100PF J	
C175			CK73GB1H104K	CHIP C 0.10UF K		C271-274			CK73HB1H102K	CHIP C 1000PF K	
C176			CK73GB1H471K	CHIP C 470PF K		C275			CC73HCH1H270G	CHIP C 27PF G	
C177			CK73GB1H103K	CHIP C 0.010UF K		C276			CC73HCH1H150G	CHIP C 15PF G	
C178			C93-0553-05	CHIP C 3.0PF C		C279-281			CK73HB1H102K	CHIP C 1000PF K	
C179			CK73HB1H102K	CHIP C 1000PF K		C283-288			CK73HB1H102K	CHIP C 1000PF K	
C180			CK73HB1H471K	CHIP C 470PF K		C292			CK73HB1A104K	CHIP C 0.10UF K	
C181			CK73GB1H103K	CHIP C 0.010UF K		C293			CC73HCH1H030B	CHIP C 3.0PF B	
C182			CK73HB1H102K	CHIP C 1000PF K		C294			CC73HCH1H070B	CHIP C 7.0PF B	
C183,184			CK73HB1H471K	CHIP C 470PF K		C295			CK73HB1H102K	CHIP C 1000PF K	
C185			C93-0551-05	CHIP C 1.5PF C		C296,297			CC73HCH1H040B	CHIP C 4.0PF B	
C186			C93-0552-05	CHIP C 2.0PF C		C298			CK73HB1H102K	CHIP C 1000PF K	
C188			CC73FCH1H220J	CHIP C 22PF J		C299			CC73HCH1H110G	CHIP C 11PF G	
C189			CC73FCH1H070B	CHIP C 7.0PF B		C300			CK73HB1A104K	CHIP C 0.10UF K	
C190			C93-0554-05	CHIP C 4.0PF C		C301			CK73HB1H102K	CHIP C 1000PF K	
C190			C93-0555-05	CHIP C 5.0PF C		C302			CK73HB1A104K	CHIP C 0.10UF K	
C191			C93-0603-05	CHIP C 1000PF K		C303			CK73HB1H102K	CHIP C 1000PF K	
C192			C93-0556-05	CHIP C 6.0PF D		C305-310			CK73HB1H102K	CHIP C 1000PF K	
C193			C93-0562-05	CHIP C 15PF J		C311			CC73HCH1H020B	CHIP C 2.0PF B	
C194			C93-0553-05	CHIP C 3.0PF C		C312-316			CK73HB1H102K	CHIP C 1000PF K	
C195			C93-0554-05	CHIP C 4.0PF C		C317			CC73HCH1H020B	CHIP C 2.0PF B	
C196			CC73FCH1HR75B	CHIP C 0.75PF B		C321,322			CK73HB1H102K	CHIP C 1000PF K	

K,M4
E

PARTS LIST

TX-RX UNIT (X57-731X-XX)

Ref. No.	Address	New parts	Parts No.	Description	Desti-nation	Ref. No.	Address	New parts	Parts No.	Description	Desti-nation
C324-327			CK73HB1H102K	CHIP C 1000PF K		C435			CK73GB1H471K	CHIP C 470PF K	
C329-335			CK73HB1H102K	CHIP C 1000PF K		C436-438			CK73HB1H471K	CHIP C 470PF K	
C337-340			CK73HB1H102K	CHIP C 1000PF K		C439			CC73HCH1H050B	CHIP C 5.0PF B	
C343,344			CC73HCH1H0R5B	CHIP C 0.5PF B		C440-442			CK73HB1H471K	CHIP C 470PF K	
C345			CC73HCH1H040B	CHIP C 4.0PF B		C443			CC73HCH1H060B	CHIP C 6.0PF B	
C346,347			CK73HB1H102K	CHIP C 1000PF K		C444-448			CK73HB1H471K	CHIP C 470PF K	
C349-354			CK73HB1H102K	CHIP C 1000PF K		C449			CC73HCH1H020B	CHIP C 2.0PF B	
C355			CC73HCH1H070B	CHIP C 7.0PF B		C450			CK73HB1E103K	CHIP C 0.010UF K	
C356			CC73HCH1H820J	CHIP C 82PF J		C452			CK73HB1H471K	CHIP C 470PF K	
C357			CC73HCH1H150G	CHIP C 15PF G		C455			CC73HCH1H020B	CHIP C 2.0PF B	
C358			CC73HCH1H181J	CHIP C 180PF J		C457			CC73HCH1H020B	CHIP C 2.0PF B	
C359			CK73HB1H102K	CHIP C 1000PF K		C458			CC73HCH1H101J	CHIP C 100PF J	
C360			CC73HCH1H100B	CHIP C 10PF B		C459			CC73HCH1H020B	CHIP C 2.0PF B	
C361			CK73HB1A104K	CHIP C 0.10UF K		C460,461			CC73HCH1H101J	CHIP C 100PF J	
C363			CC73HCH1H020B	CHIP C 2.0PF B		C462			CC73HCH1H020B	CHIP C 2.0PF B	
C364			CC73HCH1H100B	CHIP C 10PF B		C463			CK73HB1H102K	CHIP C 1000PF K	
C365			CK73HB1H471K	CHIP C 470PF K		C464			CC73HCH1H101J	CHIP C 100PF J	
C366			CC73HCH1H030B	CHIP C 3.0PF B		C465			CK73HB1H222K	CHIP C 2200PF K	
C367			CC73HCH1H470J	CHIP C 47PF J		C466-469			CC73HCH1H101J	CHIP C 100PF J	
C368			CK73HB1H471K	CHIP C 470PF K		C470			CK73HB1E103K	CHIP C 0.010UF K	
C369			CC73HCH1H180G	CHIP C 18PF G		C471			CK73HB1H102K	CHIP C 1000PF K	
C370			CK73HB1A104K	CHIP C 0.10UF K		C472			CC73HCH1H030B	CHIP C 3.0PF B	
C371,372			CK73HB1H102K	CHIP C 1000PF K		C473			CC73HCH1H101J	CHIP C 100PF J	
C373			CK73HB1H471K	CHIP C 470PF K		C474			CC73HCH1H030B	CHIP C 3.0PF B	
C375			CC73HCH1H120G	CHIP C 12PF G		C475			CK73HB1H471K	CHIP C 470PF K	
C376			CK73HB1H471K	CHIP C 470PF K		C476			CC73HCH1H820J	CHIP C 82PF J	
C378			CK73HB1H471K	CHIP C 470PF K		C477			CC73HCH1H101J	CHIP C 100PF J	
C379			CC73HCH1H470J	CHIP C 47PF J		C478			CC73HCH1H100B	CHIP C 10PF B	
C380-382			CK73HB1H471K	CHIP C 470PF K		C480			CC73HCH1H050B	CHIP C 5.0PF B	
C383			CC73HCH1H1R5B	CHIP C 1.5PF B		C486			CK73HB1A104K	CHIP C 0.10UF K	
C384-388			CK73HB1H471K	CHIP C 470PF K		C487			CK73HB1H391K	CHIP C 390PF K	
C389			CC73HCH1H060B	CHIP C 6.0PF B		C488			CK73HB1H392K	CHIP C 3900PF K	
C390			CK73HB1H471K	CHIP C 470PF K		C489			CC73HCH1H101J	CHIP C 100PF J	
C391,392			CC73HCH1H470J	CHIP C 47PF J		C491			CC73HCH1H180G	CHIP C 18PF G	
C393			CK73GB1H471K	CHIP C 470PF K		C493			CS77AA1A100M	CHIP TNTL 10UF 10WV	
C394			CK73HB1H471K	CHIP C 470PF K		C494			CK73HB1A104K	CHIP C 0.10UF K	
C395			CC73HCH1H050B	CHIP C 5.0PF B		C495			CK73HB1H102K	CHIP C 1000PF K	
C396-398			CK73HB1H471K	CHIP C 470PF K		C496			CK73HB0J105K	CHIP C 1.0UF K	
C399			CC73HCH1H040B	CHIP C 4.0PF B		C497			CK73HB1A104K	CHIP C 0.10UF K	
C400-405			CK73HB1H471K	CHIP C 470PF K		C498			CC73HCH1H820J	CHIP C 82PF J	
C406			CC73HCH1H020B	CHIP C 2.0PF B		C499-501			CK73HB1A104K	CHIP C 0.10UF K	
C407			CC73HCH1H070B	CHIP C 7.0PF B		C502			CK73HB0J105K	CHIP C 1.0UF K	
C408			CC73HCH1H020B	CHIP C 2.0PF B		C503,504			CK73HB1A104K	CHIP C 0.10UF K	
C409			CC73HCH1H100B	CHIP C 10PF B		C505			CK73GB1A105K	CHIP C 1.0UF K	
C410			CK73HB1H471K	CHIP C 470PF K		C507			CK73HB1A104K	CHIP C 0.10UF K	
C411			CC73HCH1H030B	CHIP C 3.0PF B		C509			CC73HCH1H560J	CHIP C 56PF J	
C413			CK73HB1H471K	CHIP C 470PF K		C511			CK73HB1E103K	CHIP C 0.010UF K	
C414			CC73HCH1H150G	CHIP C 15PF G		C512,513			CK73HB1H102K	CHIP C 1000PF K	
C415			CK73HB1A104K	CHIP C 0.10UF K		C514			CK73HB1A104K	CHIP C 0.10UF K	
C416,417			CK73HB1H102K	CHIP C 1000PF K		C515,516			CK73HB1H102K	CHIP C 1000PF K	
C418			CK73HB1H471K	CHIP C 470PF K		C518			CK73HB1A104K	CHIP C 0.10UF K	
C419			CK73HB1A104K	CHIP C 0.10UF K		C519			CC73HCH1H110G	CHIP C 11PF G	
C420			CC73HCH1H120G	CHIP C 12PF G		C521-525			CK73HB1A104K	CHIP C 0.10UF K	
C421			CK73HB1H471K	CHIP C 470PF K		C527,528			CK73HB1A104K	CHIP C 0.10UF K	
C422			CC73HCH1H1R5B	CHIP C 1.5PF B		C531-534			CK73GB0J475K	CHIP C 4.7UF K	
C423			CK73HB1H471K	CHIP C 470PF K		C538			CC73HCH1H050B	CHIP C 5.0PF B	
C425-427			CK73HB1H471K	CHIP C 470PF K		C539			CC73HCH1H220G	CHIP C 22PF G	
C428			CC73HCH1H1R5B	CHIP C 1.5PF B		C540			C93-0570-05	CHIP C 68PF J	
C429-433			CK73HB1H471K	CHIP C 470PF K		C541			CC73HCH1H070B	CHIP C 7.0PF B	
C434			CC73HCH1H040B	CHIP C 4.0PF B		C542			CC73HCH1H090B	CHIP C 9.0PF B	

PARTS LIST

TX-RX UNIT (X57-731X-XX)

Ref. No.	Address	New parts	Parts No.	Description	Destination	Ref. No.	Address	New parts	Parts No.	Description	Destination
C544			CK73HB1H102K	CHIP C 1000PF K		C661			CC73HCH1H470J	CHIP C 47PF J	
C545			CK73HB1C223K	CHIP C 0.022UF K		C662			CK73GB1H103K	CHIP C 0.010UF K	
C546			CK73HB1E103K	CHIP C 0.010UF K		C664			CK73HB1H102K	CHIP C 1000PF K	
C548			CC73HCH1H220G	CHIP C 22PF G		C665			CK73GB1A105K	CHIP C 1.0UF K	
C549			CK73HB1A104K	CHIP C 0.10UF K		C666,667			CK73HB1A104K	CHIP C 0.10UF K	
C551			CC73HCH1H090B	CHIP C 9.0PF B		C668			CK73HB1H102K	CHIP C 1000PF K	
C552			CK73HB1H391K	CHIP C 390PF K		C669			CS77AA1A100M	CHIP TNTL 10UF 10WV	
C553			CK73HB1H392K	CHIP C 3900PF K		C670			CC73HCH1H470J	CHIP C 47PF J	
C554			CC73HCH1H101J	CHIP C 100PF J		C671			CK73GB1A105K	CHIP C 1.0UF K	
C555			C93-0555-05	CHIP C 5.0PF C		C672			CC73HCH1H101J	CHIP C 100PF J	
C556			CK73HB1H102K	CHIP C 1000PF K		C673			CC73HCH1H270G	CHIP C 27PF G	
C557			CC73HCH1H910J	CHIP C 91PF J		C674			CC73HCH1H470J	CHIP C 47PF J	
C558,559			CK73HB1A104K	CHIP C 0.10UF K		C675,676			CC73HCH1H101J	CHIP C 100PF J	
C560			CK73GB1A105K	CHIP C 1.0UF K		C677-686			CK73HB1A104K	CHIP C 0.10UF K	
C561			CK73HB1A104K	CHIP C 0.10UF K		C687			CK73HB0J105K	CHIP C 1.0UF K	
C562			CS77AA1A100M	CHIP TNTL 10UF 10WV		C689			CC73HCH1H1R5B	CHIP C 1.5PF B	
C563			CK73HB1A104K	CHIP C 0.10UF K		C690			CC73HCH1H030B	CHIP C 3.0PF B	
C565			CC73HCH1H120G	CHIP C 12PF G		C693			CC73HCH1H1R5B	CHIP C 1.5PF B	
C567-574			CK73HB1A104K	CHIP C 0.10UF K		C694			CC73HCH1H030B	CHIP C 3.0PF B	
C576,577			CK73HB1A104K	CHIP C 0.10UF K		C697			CC73HCH1H070B	CHIP C 7.0PF B	
C579-581			CK73GB1E105K	CHIP C 1.0UF K		C698			CC73HCH1H270G	CHIP C 27PF G	
C583-592			CK73GB1E105K	CHIP C 1.0UF K		C699			CC73HCH1H070B	CHIP C 7.0PF B	
C593			C93-0555-05	CHIP C 5.0PF C		C701,702			CK73HB1H102K	CHIP C 1000PF K	
C594,595			CE32CL1C470M	CHIP EL 47UF 16WV		C704			CK73HB1H471K	CHIP C 470PF K	
C596			CK73HB1H102K	CHIP C 1000PF K		C708			CK73HB1H471K	CHIP C 470PF K	
C597			CK73GB1E105K	CHIP C 1.0UF K		C710,711			CK73HB1H102K	CHIP C 1000PF K	
C598,599			CK73GB1H104K	CHIP C 0.10UF K		C712			CK73HB1H471K	CHIP C 470PF K	
C600			CK73GB1E105K	CHIP C 1.0UF K		C713,714			CK73HB1H102K	CHIP C 1000PF K	
C601			CK73GB1A105K	CHIP C 1.0UF K		C715			CK73HB1H471K	CHIP C 470PF K	
C602,603			CK73GB1H104K	CHIP C 0.10UF K		C716			CK73HB1E103K	CHIP C 0.010UF K	
C604			CK73HB1H471K	CHIP C 470PF K		C717			CC73HCH1H390J	CHIP C 39PF J	
C605			CC73HCH1H470J	CHIP C 47PF J		C718			CK73HB1E103K	CHIP C 0.010UF K	
C606			CK73GB0J475K	CHIP C 4.7UF K		C719			CC73HCH1H050B	CHIP C 5.0PF B	
C607			CK73HB1A104K	CHIP C 0.10UF K		C720,721			CC73HCH1H0R5B	CHIP C 0.5PF B	
C608			CK73GB1H104K	CHIP C 0.10UF K		C722			CC73HCH1H030B	CHIP C 3.0PF B	
C609			CK73GB1A105K	CHIP C 1.0UF K		C723			CC73HCH1H060B	CHIP C 6.0PF B	
C610			CC73HCH1H121J	CHIP C 120PF J		C724			CC73HCH1H120G	CHIP C 12PF G	
C611,612			CK73GB1H104K	CHIP C 0.10UF K		C725			CC73HCH1H040B	CHIP C 4.0PF B	
C613			CS77AA1A100M	CHIP TNTL 10UF 10WV		C727			CC73HCH1H050B	CHIP C 5.0PF B	
C614			CK73HB1A473K	CHIP C 0.047UF K		C728			CK73HB1H102K	CHIP C 1000PF K	
C615,616			CK73GB1H104K	CHIP C 0.10UF K		C729,730			CC73HCH1H0R5B	CHIP C 0.5PF B	
C617			CK73GB1H102K	CHIP C 1000PF K		C731,732			CK73HB1H471K	CHIP C 470PF K	
C618			CK73HB0J105K	CHIP C 1.0UF K		C733			CC73HCH1H220G	CHIP C 22PF G	
C619			CC73HCH1H101J	CHIP C 100PF J		C734			CK73HB1H471K	CHIP C 470PF K	
C620			CD04AZ1E471M	ELECTRO 470UF 25WV		C735			CK73GB1H104K	CHIP C 0.10UF K	
C621-624			CC73HCH1H101J	CHIP C 100PF J		C736			CC73HCH1H0R5B	CHIP C 0.5PF B	
C625,626			CD04AZ1E471M	ELECTRO 470UF 25WV		C751,752			CK73HB1H102K	CHIP C 1000PF K	
C627-634			CC73HCH1H101J	CHIP C 100PF J		C754			CK73HB1H471K	CHIP C 470PF K	
C642			CS77AA1A100M	CHIP TNTL 10UF 10WV		C758			CK73HB1H471K	CHIP C 470PF K	
C643,644			CK73HB1H102K	CHIP C 1000PF K		C760,761			CK73HB1H102K	CHIP C 1000PF K	
C645,646			CC73HCH1H470J	CHIP C 47PF J		C762			CK73HB1H471K	CHIP C 470PF K	
C647			CK73GB1H471K	CHIP C 470PF K		C763,764			CK73HB1H102K	CHIP C 1000PF K	
C649,650			CC73HCH1H470J	CHIP C 47PF J		C765			CK73HB1H471K	CHIP C 470PF K	
C651			CE32CL1C470M	CHIP EL 47UF 16WV		C766			CK73HB1E103K	CHIP C 0.010UF K	
C652			CC73HCH1H470J	CHIP C 47PF J		C767			CC73HCH1H390J	CHIP C 39PF J	
C653			CK73GB1H102K	CHIP C 1000PF K		C768			CK73HB1E103K	CHIP C 0.010UF K	
C655			CK73HB1E103K	CHIP C 0.010UF K		C769			CC73HCH1H050B	CHIP C 5.0PF B	
C656			CC73HCH1H470J	CHIP C 47PF J		C770,771			CC73HCH1H0R5B	CHIP C 0.5PF B	
C659			CC73HCH1H470J	CHIP C 47PF J		C772			CC73HCH1H030B	CHIP C 3.0PF B	
C660			CK73GB1A105K	CHIP C 1.0UF K		C773			CC73HCH1H060B	CHIP C 6.0PF B	

PARTS LIST

TX-RX UNIT (X57-731X-XX)

Ref. No.	Address	New parts	Parts No.	Description	Desti-nation	Ref. No.	Address	New parts	Parts No.	Description	Desti-nation
C774			CC73HCH1H120G	CHIP C 12PF G		C865			CS77CA1A4R7M	CHIP TNTL 4.7UF 10WV	
C775			CC73HCH1H040B	CHIP C 4.0PF B		C866,867			CK73HB1E562K	CHIP C 5600PF K	
C777			CC73HCH1H050B	CHIP C 5.0PF B		C868			CC73HCH1H221J	CHIP C 220PF J	
C778			CK73HB1H102K	CHIP C 1000PF K		C869			CK73HB0J105K	CHIP C 1.0UF K	
C779,780			CC73HCH1H0R5B	CHIP C 0.5PF B		C870			CK73HB1H102K	CHIP C 1000PF K	
C781,782			CK73HB1H471K	CHIP C 470PF K		C872			CS77AA1A100M	CHIP TNTL 10UF 10WV	
C783			CC73HCH1H220G	CHIP C 22PF G		C873			CK73HB0J105K	CHIP C 1.0UF K	
C784			CK73HB1H471K	CHIP C 470PF K		C874			CK73HB1A104K	CHIP C 0.10UF K	
C785			CK73GB1H104K	CHIP C 0.10UF K		C875,876			CK73HB1H102K	CHIP C 1000PF K	
C786			CC73HCH1H0R5B	CHIP C 0.5PF B		C877			CK73HB1H561K	CHIP C 560PF K	
C803,804			CE32BF1E331M	CHIP EL 330UF 25WV		C878			CC73HCH1H470J	CHIP C 47PF J	
C805			CK73GB1H104K	CHIP C 0.10UF K		C879,880			CK73HB1A104K	CHIP C 0.10UF K	
C806,807			CE32BF1E331M	CHIP EL 330UF 25WV		C881			CK73HB1H102K	CHIP C 1000PF K	
C808			CK73GB0J475K	CHIP C 4.7UF K		C882			CC73HCH1H470J	CHIP C 47PF J	
C809			CK73HB1H102K	CHIP C 1000PF K		C883			CC73HCH1H220G	CHIP C 22PF G	
C810			CE32CL1C470M	CHIP EL 47UF 16WV		C884			CK73HB1H472K	CHIP C 4700PF K	
C811			CS77CA1A4R7M	CHIP TNTL 4.7UF 10WV		C885			CK73HB1H561K	CHIP C 560PF K	
C812			CK73HB1A473K	CHIP C 0.047UF K		C887			CK73HB0J105K	CHIP C 1.0UF K	
C813			C92-0661-05	CHIP TNTL 2.2UF 10WV		C889			CK73HB1H681K	CHIP C 680PF K	
C814			CK73HB1H561K	CHIP C 560PF K		C891			CK73HB0J105K	CHIP C 1.0UF K	
C815			CK73HB1A393K	CHIP C 0.039UF K		C892			CK73HB1H102K	CHIP C 1000PF K	
C816			CK73HB1A104K	CHIP C 0.10UF K		C893			CK73HB1A104K	CHIP C 0.10UF K	
C817			CK73HB1H102K	CHIP C 1000PF K		C894			CS77AA1A100M	CHIP TNTL 10UF 10WV	
C818			CK73HB1A104K	CHIP C 0.10UF K		C895-906			CK73HB0J105K	CHIP C 1.0UF K	
C819			CK73HB1H102K	CHIP C 1000PF K		C907,908			CK73HB1H102K	CHIP C 1000PF K	
C820			CK73HB1A104K	CHIP C 0.10UF K		C909			CS77AA1A100M	CHIP TNTL 10UF 10WV	
C821,822			CK73GB1C474K	CHIP C 0.47UF K		C910			CK73HB1H102K	CHIP C 1000PF K	
C823,824			CK73HB1H102K	CHIP C 1000PF K		C914			CK73HB1E682K	CHIP C 6800PF K	
C825			CC73HCH1H121J	CHIP C 120PF J		C915			CK73HB1C822K	CHIP C 8200PF K	
C826			CK73HB1A104K	CHIP C 0.10UF K		C916			CK73HB1A104K	CHIP C 0.10UF K	
C827			CK73HB1H272K	CHIP C 2700PF K		C917,918			CK73HB1H102K	CHIP C 1000PF K	
C828,829			CK73GB1A105K	CHIP C 1.0UF K		C919-922			CC73HCH1H220G	CHIP C 22PF G	
C830			CK73HB1A104K	CHIP C 0.10UF K		C923			CK73HB1H102K	CHIP C 1000PF K	
C831			CK73HB1H332K	CHIP C 3300PF K		C924			CC73HCH1H101J	CHIP C 100PF J	
C832			CK73HB1H561K	CHIP C 560PF K		C926			CK73HB1H681K	CHIP C 680PF K	
C833			CK73HB1H102K	CHIP C 1000PF K		C928			CK73GB1H102K	CHIP C 1000PF K	
C834-837			CK73HB1E103K	CHIP C 0.010UF K		C929			CK73HB1A104K	CHIP C 0.10UF K	
C838			CK73HB1C822K	CHIP C 8200PF K		C930,931			CK73HB1H102K	CHIP C 1000PF K	
C839			CK73HB1A104K	CHIP C 0.10UF K		C932			CK73HB0J105K	CHIP C 1.0UF K	
C840,841			CS77CA1A4R7M	CHIP TNTL 4.7UF 10WV		C933			CK73HB1H102K	CHIP C 1000PF K	
C842			CK73HB1H332K	CHIP C 3300PF K		C934			CK73HB0J105K	CHIP C 1.0UF K	
C843			CC73HCH1H221J	CHIP C 220PF J		C935-937			CK73HB1H102K	CHIP C 1000PF K	
C844			CK73HB1H561K	CHIP C 560PF K		C938,939			CK73HB1A104K	CHIP C 0.10UF K	
C845,846			CK73HB1H472K	CHIP C 4700PF K		C941			CK73HB1H472K	CHIP C 4700PF K	
C847			CK73HB1H102K	CHIP C 1000PF K		C943			CK73HB1H102K	CHIP C 1000PF K	
C848			CK73HB0J105K	CHIP C 1.0UF K		C944			CK73HB0J105K	CHIP C 1.0UF K	
C849,850			CK73HB1H472K	CHIP C 4700PF K		C945			CK73HB1A104K	CHIP C 0.10UF K	
C851			CK73HB1H102K	CHIP C 1000PF K		C946			CK73HB1H102K	CHIP C 1000PF K	
C852			CK73HB1A473K	CHIP C 0.047UF K		C947			CK73GB1A105K	CHIP C 1.0UF K	
C853			CK73HB1H102K	CHIP C 1000PF K		C948			CK73HB1H102K	CHIP C 1000PF K	
C854			CK73HB1A473K	CHIP C 0.047UF K		C949			CK73GB1H104K	CHIP C 0.10UF K	
C855			CK73HB1A104K	CHIP C 0.10UF K		C950			CK73GB1C473K	CHIP C 0.047UF K	
C856			CK73HB1H102K	CHIP C 1000PF K		C951			CK73HB1H102K	CHIP C 1000PF K	
C857			CK73HB1A104K	CHIP C 0.10UF K		C952			CK73GB1A105K	CHIP C 1.0UF K	
C858			CK73HB1H102K	CHIP C 1000PF K		C953			CK73GB0J475K	CHIP C 4.7UF K	
C859			CK73HB1H122K	CHIP C 1200PF K		C954			CK73GB1H102K	CHIP C 1000PF K	
C860			CK73HB1H102K	CHIP C 1000PF K		C955			CK73HB1H102K	CHIP C 1000PF K	
C861			CK73HB0J105K	CHIP C 1.0UF K		C957			CK73HB1H102K	CHIP C 1000PF K	
C862			CK73HB1H122K	CHIP C 1200PF K		C958			CK73HB1A104K	CHIP C 0.10UF K	
C863,864			CK73HB1E103K	CHIP C 0.010UF K		C960			CK73HB1H102K	CHIP C 1000PF K	

TM-D710A/D710E

PARTS LIST

TX-RX UNIT (X57-731X-XX)

Ref. No.	Address	New parts	Parts No.	Description	Destination	Ref. No.	Address	New parts	Parts No.	Description	Destination
C962			CK73HB1H102K	CHIP C 1000PF K		L67			L40-4775-92	SMALL FIXED INDUCTOR (47NH)	
C963			CE32CL1C470M	CHIP EL 47UF 16WV		L131			L40-5675-92	SMALL FIXED INDUCTOR (56NH)	
C964			CK73HB1H102K	CHIP C 1000PF K		L132			L92-0443-05	CHIP FERRITE	
C966			CK73HB1H102K	CHIP C 1000PF K		L133			L34-0742-05	AIR-CORE COIL	
C967-969			CK73HB1E103K	CHIP C 0.010UF K		L135			L34-0742-05	AIR-CORE COIL	
C970			CE32BF1E331M	CHIP EL 330UF 25WV		L136			L34-4865-05	AIR-CORE COIL	
C971			CK73GB1E105K	CHIP C 1.0UF K		L161,162			L40-2275-92	SMALL FIXED INDUCTOR (22NH)	
C972			CK73GB1H104K	CHIP C 0.10UF K		L163			L92-0443-05	CHIP FERRITE	
C973			CE32BC1D220M	CHIP EL 22UF 20WV		L164			L34-0742-05	AIR-CORE COIL	
C974			CK73HB1H102K	CHIP C 1000PF K		L165			L34-4811-05	AIR-CORE COIL	
C975			CK73GB1H104K	CHIP C 0.10UF K		L166			L34-1239-05	AIR-CORE COIL	
C976			CK73HB1H102K	CHIP C 1000PF K		L186			L34-0894-05	AIR-CORE COIL	
C977			CK73HB1A104K	CHIP C 0.10UF K		L187			L34-1185-05	AIR-CORE COIL	
C978			CK73HB1H102K	CHIP C 1000PF K		L188			L34-4811-05	AIR-CORE COIL	
C979			CK73HB1A104K	CHIP C 0.10UF K		L189			L34-1228-05	AIR-CORE COIL	
C980			CK73GB1E105K	CHIP C 1.0UF K		L190			L41-3378-03	SMALL FIXED INDUCTOR (33NH)	
C981			CK73GB1C474K	CHIP C 0.47UF K		L191			L41-1278-03	SMALL FIXED INDUCTOR (12NH)	
C982			CK73HB1H102K	CHIP C 1000PF K		L192			L34-4810-05	AIR-CORE COIL	
C983			CK73GB1H102K	CHIP C 1000PF K		L193			L34-4811-05	AIR-CORE COIL	
C984,985			CK73HB1H102K	CHIP C 1000PF K		L194			L34-1052-05	AIR-CORE COIL	
C986			CK73HB1E103K	CHIP C 0.010UF K		L195			L34-4864-05	AIR-CORE COIL	
C988			CK73HB1A104K	CHIP C 0.10UF K		L196			L34-4811-05	AIR-CORE COIL	
C991			CC73HCH1H470J	CHIP C 47PF J		L197			L40-1875-92	SMALL FIXED INDUCTOR (18NH)	
CN641			E40-6525-05	PIN ASSY		L198			L34-4874-05	AIR-CORE COIL	
CN642			E40-6389-05	PIN ASSY		L227,228			L40-4775-92	SMALL FIXED INDUCTOR (47NH)	
CN676			E40-6525-05	PIN ASSY		L229,230			L41-5685-14	SMALL FIXED INDUCTOR (560NH)	
CN677			E40-6745-05	FLAT CABLE CONNECTOR		L231			L40-2785-92	SMALL FIXED INDUCTOR (270NH)	
CN701			E40-6771-05	PIN ASSY		L232			L41-1188-03	SMALL FIXED INDUCTOR (110NH)	
CN702			E40-6770-05	PIN ASSY		L233			L41-5678-03	SMALL FIXED INDUCTOR (56NH)	
CN751			E40-6771-05	PIN ASSY		L234			L41-3385-14	SMALL FIXED INDUCTOR (330NH)	
CN752			E40-6770-05	PIN ASSY		L236,237			L41-5678-03	SMALL FIXED INDUCTOR (56NH)	
CN960			E40-6745-05	FLAT CABLE CONNECTOR		L242			L40-2785-92	SMALL FIXED INDUCTOR (270NH)	
CN961			E40-6527-05	PIN ASSY		L244			L41-1088-03	SMALL FIXED INDUCTOR (100NH)	
J606			E56-0411-05	DIN SOCKET		L245			L41-5678-03	SMALL FIXED INDUCTOR (56NH)	
J607			E56-0405-05	DIN SOCKET		L246			L41-3988-14	SMALL FIXED INDUCTOR (390NH)	
J801,802			E11-0425-05	3.5D PHONE JACK (3P)		L248,249			L41-6878-03	SMALL FIXED INDUCTOR (68NH)	
J951			E58-0523-05	MODULAR JACK		L254			L40-2785-92	SMALL FIXED INDUCTOR (270NH)	
J952			E58-0527-05	MODULAR JACK		L255			L41-5685-14	SMALL FIXED INDUCTOR (560NH)	
W601			E37-1403-05	PROCESSED LEAD WIRE	K,M4	L256			L41-3388-03	SMALL FIXED INDUCTOR (330NH)	
101	2B		F10-3082-04	SHIELDING CASE		L257			L41-1278-03	SMALL FIXED INDUCTOR (12NH)	
F576,577			F53-0392-05	FUSE (3A)		L258			L41-1578-03	SMALL FIXED INDUCTOR (15NH)	
F641			F53-0128-05	FUSE (0.5A)		L259,260			L41-1278-03	SMALL FIXED INDUCTOR (12NH)	
F951			F53-0323-05	FUSE (2A)		L292,293			L40-4775-92	SMALL FIXED INDUCTOR (47NH)	
CD486			L79-1701-05	TUNING COIL		L294,295			L41-4785-14	SMALL FIXED INDUCTOR (470NH)	
CD546			L79-1582-05	TUNING COIL		L296			L40-2785-92	SMALL FIXED INDUCTOR (270NH)	
CF486			L72-1035-05	CERAMIC FILTER		L297			L41-1188-03	SMALL FIXED INDUCTOR (110NH)	
CF487			L72-1036-05	CERAMIC FILTER		L298			L41-5678-03	SMALL FIXED INDUCTOR (56NH)	
CF546			L72-1034-05	CERAMIC FILTER		L299			L41-3385-14	SMALL FIXED INDUCTOR (330NH)	
CF547			L72-0999-05	CERAMIC FILTER		L301,302			L41-5678-03	SMALL FIXED INDUCTOR (56NH)	
L2			L40-4775-92	SMALL FIXED INDUCTOR (47NH)		L307			L40-2785-92	SMALL FIXED INDUCTOR (270NH)	
L10			L40-1875-92	SMALL FIXED INDUCTOR (18NH)		L308			L41-5685-14	SMALL FIXED INDUCTOR (560NH)	
L11			L40-2275-92	SMALL FIXED INDUCTOR (22NH)		L309			L41-1088-03	SMALL FIXED INDUCTOR (100NH)	
L12			L40-8265-92	SMALL FIXED INDUCTOR (8.2NH)		L310			L41-5678-03	SMALL FIXED INDUCTOR (56NH)	
L13			L40-1875-92	SMALL FIXED INDUCTOR (18NH)		L311			L41-3988-14	SMALL FIXED INDUCTOR (390NH)	
L14			L40-2275-92	SMALL FIXED INDUCTOR (22NH)		L312			L41-1578-03	SMALL FIXED INDUCTOR (15NH)	
L15			L40-8265-92	SMALL FIXED INDUCTOR (8.2NH)		L313,314			L41-6878-03	SMALL FIXED INDUCTOR (68NH)	
L16,17			L40-3975-92	SMALL FIXED INDUCTOR (39NH)		L319			L40-2785-92	SMALL FIXED INDUCTOR (270NH)	
L19-22			L40-3975-92	SMALL FIXED INDUCTOR (39NH)		L320			L41-5685-14	SMALL FIXED INDUCTOR (560NH)	
						L321			L41-3388-03	SMALL FIXED INDUCTOR (330NH)	
						L322-324			L41-1278-03	SMALL FIXED INDUCTOR (12NH)	

PARTS LIST

TX-RX UNIT (X57-731X-XX)

Ref. No.	Address	New parts	Parts No.	Description	Destination	Ref. No.	Address	New parts	Parts No.	Description	Destination
L356			L41-5678-03	SMALL FIXED INDUCTOR (56NH)		L704,705			L41-1098-08	SMALL FIXED INDUCTOR (1.0UH)	
L357			L41-3988-14	SMALL FIXED INDUCTOR (390NH)		L706			L41-3378-08	SMALL FIXED INDUCTOR (33NH)	
L358			L41-5678-03	SMALL FIXED INDUCTOR (56NH)		L707			L41-2278-08	SMALL FIXED INDUCTOR (22NH)	
L359			L41-3385-14	SMALL FIXED INDUCTOR (330NH)		L708			L41-1878-08	SMALL FIXED INDUCTOR (18NH)	
L361			L40-1275-92	SMALL FIXED INDUCTOR (12NH)		L709			L41-1098-08	SMALL FIXED INDUCTOR (1.0UH)	
L362			L40-1875-92	SMALL FIXED INDUCTOR (18NH)		L710,711			L41-1095-14	SMALL FIXED INDUCTOR (1.0UF)	
L363			L41-1585-14	SMALL FIXED INDUCTOR (150NH)		L712			L40-1585-92	SMALL FIXED INDUCTOR (150NH)	
L364			L41-4785-14	SMALL FIXED INDUCTOR (470NH)		L751,752			L41-1098-08	SMALL FIXED INDUCTOR (1.0UH)	
L365			L40-2785-92	SMALL FIXED INDUCTOR (270NH)		L753			L41-1278-08	SMALL FIXED INDUCTOR (12NH)	
L366			L41-1578-03	SMALL FIXED INDUCTOR (15NH)		L754,755			L41-1098-08	SMALL FIXED INDUCTOR (1.0UH)	
L368			L41-1578-03	SMALL FIXED INDUCTOR (15NH)		L756			L41-3378-08	SMALL FIXED INDUCTOR (33NH)	
L370			L41-1578-03	SMALL FIXED INDUCTOR (15NH)		L757			L41-2278-08	SMALL FIXED INDUCTOR (22NH)	
L371			L40-1091-86	SMALL FIXED INDUCTOR (1.0UH)		L758			L41-1878-08	SMALL FIXED INDUCTOR (18NH)	
L372			L41-2288-03	SMALL FIXED INDUCTOR (220NH)		L759			L41-1098-08	SMALL FIXED INDUCTOR (1.0UH)	
L375			L41-1278-03	SMALL FIXED INDUCTOR (12NH)		L760,761			L41-1095-14	SMALL FIXED INDUCTOR (1.0UF)	
L376			L41-2288-03	SMALL FIXED INDUCTOR (220NH)		L762			L40-1585-92	SMALL FIXED INDUCTOR (150NH)	
L377			L41-1578-03	SMALL FIXED INDUCTOR (15NH)		L916,917			L92-0443-05	CHIP FERRITE	
L378			L40-1091-86	SMALL FIXED INDUCTOR (1.0UH)		L921,922			L41-3385-14	SMALL FIXED INDUCTOR (330NH)	
L379			L41-2288-03	SMALL FIXED INDUCTOR (220NH)		L951,952			L92-0443-05	CHIP FERRITE	
L380			L41-4378-03	SMALL FIXED INDUCTOR (43NH)		X1			L77-3018-05	TCXO (12.8MHZ)	
L406			L40-1275-92	SMALL FIXED INDUCTOR (12NH)		X66			L77-3017-05	TCXO (16.8MHZ)	
L407			L40-1875-92	SMALL FIXED INDUCTOR (18NH)		X486			L77-3021-05	CRYSTAL RESONATOR (45.505MHZ)	
L408			L41-1585-14	SMALL FIXED INDUCTOR (150NH)		X916			L77-3022-05	CRYSTAL RESONATOR (11.0592MHZ)	
L409			L41-4785-14	SMALL FIXED INDUCTOR (470NH)		X917			L78-0459-05	RESONATOR (4.19MHZ)	
L410			L40-2785-92	SMALL FIXED INDUCTOR (270NH)		XF486			L71-0642-05	MCF (45.05MHZ)	
L411			L41-1578-03	SMALL FIXED INDUCTOR (15NH)		XF546			L71-0641-05	MCF (49.95MHZ)	
L413			L41-1578-03	SMALL FIXED INDUCTOR (15NH)		CP1			RK75HA1J103J	CHIP-COM 10K J 1/16W	
L415			L41-1578-03	SMALL FIXED INDUCTOR (15NH)		CP66			RK75HA1J103J	CHIP-COM 10K J 1/16W	
L416			L40-1091-86	SMALL FIXED INDUCTOR (1.0UH)		CP576			RK74HB1J102J	CHIP-COM 1.0K J 1/16W	
L417			L41-2288-03	SMALL FIXED INDUCTOR (220NH)		CP577-579			RK74HB1J472J	CHIP-COM 4.7K J 1/16W	
L419			L41-2288-03	SMALL FIXED INDUCTOR (220NH)		CP606			RK74HB1J102J	CHIP-COM 1.0K J 1/16W	
L420			L41-1278-03	SMALL FIXED INDUCTOR (12NH)		CP666			RK75HA1J472J	CHIP-COM 4.7K J 1/16W	
L421			L40-1075-92	SMALL FIXED INDUCTOR (10NH)		CP667			RK74HB1J102J	CHIP-COM 1.0K J 1/16W	
L422			L41-1578-03	SMALL FIXED INDUCTOR (15NH)		CP801			RK74HB1J102J	CHIP-COM 1.0K J 1/16W	
L423			L40-1091-86	SMALL FIXED INDUCTOR (1.0UH)		CP802			RK74HB1J473J	CHIP-COM 47K J 1/16W	
L424			L41-2288-03	SMALL FIXED INDUCTOR (220NH)		CP803			RK74HB1J102J	CHIP-COM 1.0K J 1/16W	
L425			L41-4378-03	SMALL FIXED INDUCTOR (43NH)		CP916			RK74HB1J102J	CHIP-COM 1.0K J 1/16W	
L451			L41-1278-03	SMALL FIXED INDUCTOR (12NH)		CP917,918			RK75HA1J102J	CHIP-COM 1.0K J 1/16W	
L452			L41-1578-03	SMALL FIXED INDUCTOR (15NH)		CP919			RK74HB1J102J	CHIP-COM 1.0K J 1/16W	
L454			L41-1578-03	SMALL FIXED INDUCTOR (15NH)		CP920,921			RK74HB1J473J	CHIP-COM 47K J 1/16W	
L457,458			L40-6865-92	SMALL FIXED INDUCTOR (6.8NH)		CP922			RK74HB1J102J	CHIP-COM 1.0K J 1/16W	
L460,461			L41-8285-14	SMALL FIXED INDUCTOR (820NH)		CP923			RK75HA1J102J	CHIP-COM 1.0K J 1/16W	
L462			L40-4781-86	SMALL FIXED INDUCTOR (0.47UH)		CP924			RK74HB1J102J	CHIP-COM 1.0K J 1/16W	
L465			L40-2263-92	SMALL FIXED INDUCTOR (2.2NH)		CP925			RK75HA1J102J	CHIP-COM 1.0K J 1/16W	
L468			L40-1075-92	SMALL FIXED INDUCTOR (10NH)		CP926			RK74HB1J102J	CHIP-COM 1.0K J 1/16W	
L500			L40-4781-86	SMALL FIXED INDUCTOR (0.47UH)		CP951			RK75HA1J473J	CHIP-COM 47K J 1/16W	
L501			L40-3981-86	SMALL FIXED INDUCTOR (0.39UH)		CP952			RK74HB1J473J	CHIP-COM 47K J 1/16W	
L546,547			L41-3385-14	SMALL FIXED INDUCTOR (330NH)		R1,2			RK73HB1J104J	CHIP R 100K J 1/16W	
L606			L40-3381-86	SMALL FIXED INDUCTOR (0.33UH)		R3			RK73HH1J333D	CHIP R 33K D 1/16W	
L607,608			L41-3988-14	SMALL FIXED INDUCTOR (390NH)		R4			RK73HB1J103J	CHIP R 10K J 1/16W	
L613,614			L41-2785-14	SMALL FIXED INDUCTOR (270NH)		R7			RK73HB1J102J	CHIP R 1.0K J 1/16W	
L617,618			L41-2785-14	SMALL FIXED INDUCTOR (270NH)		R8			RK73HB1J220J	CHIP R 22 J 1/16W	
L621			L41-5685-14	SMALL FIXED INDUCTOR (560NH)		R9			RK73HB1J154J	CHIP R 150K J 1/16W	
L622			L40-8265-57	SMALL FIXED INDUCTOR (8.2NH)		R11			RK73HB1J220J	CHIP R 22 J 1/16W	
L623			L40-5675-92	SMALL FIXED INDUCTOR (56NH)		R12			RK73HB1J103J	CHIP R 10K J 1/16W	
L624,625			L40-1085-57	SMALL FIXED INDUCTOR (100NH)		R13			RK73HB1J332J	CHIP R 3.3K J 1/16W	
L626			L40-5663-57	SMALL FIXED INDUCTOR (5.6NH)		R14			RK73HB1J103J	CHIP R 10K J 1/16W	
L641,642			L92-0443-05	CHIP FERRITE		R15			RK73HB1J472J	CHIP R 4.7K J 1/16W	
L701,702			L41-1098-08	SMALL FIXED INDUCTOR (1.0UH)		R16			RK73HB1J332J	CHIP R 3.3K J 1/16W	
L703			L41-1278-08	SMALL FIXED INDUCTOR (12NH)							

PARTS LIST

TX-RX UNIT (X57-731X-XX)

Ref. No.	Address	New parts	Parts No.	Description	Destination	Ref. No.	Address	New parts	Parts No.	Description	Destination
R17			RK73HB1J682J	CHIP R 6.8K J 1/16W		R96			RK73HB1J222J	CHIP R 2.2K J 1/16W	
R18			RK73HB1J101J	CHIP R 100 J 1/16W		R97			RK73HB1J101J	CHIP R 100 J 1/16W	
R19			RK73HB1J182J	CHIP R 1.8K J 1/16W		R98			RK73HB1J823J	CHIP R 82K J 1/16W	
R20			RK73HB1J152J	CHIP R 1.5K J 1/16W		R100			RK73HB1J470J	CHIP R 47 J 1/16W	
R21			RK73HB1J391J	CHIP R 390 J 1/16W		R101			RK73HB1J472J	CHIP R 4.7K J 1/16W	
R22			RK73HB1J102J	CHIP R 1.0K J 1/16W		R102			RK73HB1J101J	CHIP R 100 J 1/16W	
R23,24			RK73HB1J332J	CHIP R 3.3K J 1/16W		R103			RK73HB1J683J	CHIP R 68K J 1/16W	
R25			RK73HB1J103J	CHIP R 10K J 1/16W		R104			RK73HB1J180J	CHIP R 18 J 1/16W	
R26			RK73HB1J102J	CHIP R 1.0K J 1/16W		R105			RK73HB1J102J	CHIP R 1.0K J 1/16W	
R27			RK73HB1J123J	CHIP R 12K J 1/16W		R106			RK73HB1J331J	CHIP R 330 J 1/16W	
R28			RK73HB1J222J	CHIP R 2.2K J 1/16W		R107-113			RK73HB1J222J	CHIP R 2.2K J 1/16W	
R29			RK73HB1J474J	CHIP R 470K J 1/16W		R114			RK73HB1J331J	CHIP R 330 J 1/16W	
R30			RK73HB1J153J	CHIP R 15K J 1/16W		R115			RK73HB1J473J	CHIP R 47K J 1/16W	
R31			RK73HB1J222J	CHIP R 2.2K J 1/16W		R116,117			RK73HB1J222J	CHIP R 2.2K J 1/16W	
R32			RK73HB1J101J	CHIP R 100 J 1/16W		R118,119			RK73HB1J102J	CHIP R 1.0K J 1/16W	
R33			RK73HB1J823J	CHIP R 82K J 1/16W		R120			RK73HB1J4R7J	CHIP R 4.7 J 1/16W	
R35			RK73HB1J470J	CHIP R 47 J 1/16W		R121,122			RK73HB1J103J	CHIP R 10K J 1/16W	
R36			RK73HB1J472J	CHIP R 4.7K J 1/16W		R123-125			RK73FB2B000J	CHIP R 0.0 J 1/8W	
R37			RK73HB1J101J	CHIP R 100 J 1/16W		R129-132			RK73HB1J222J	CHIP R 2.2K J 1/16W	
R38			RK73HB1J683J	CHIP R 68K J 1/16W		R133			RK73HB1J822J	CHIP R 8.2K J 1/16W	
R39			RK73HB1J331J	CHIP R 330 J 1/16W		R134,135			RK73GB2A100J	CHIP R 10 J 1/10W	
R40			RK73HB1J102J	CHIP R 1.0K J 1/16W		R136			RK73GB2A222J	CHIP R 2.2K J 1/10W	
R41			RK73HB1J180J	CHIP R 18 J 1/16W		R137			RK73GB2A470J	CHIP R 47 J 1/10W	
R42			RK73HB1J222J	CHIP R 2.2K J 1/16W		R138			RK73GB2A271J	CHIP R 270 J 1/10W	
R43			RK73HB1J331J	CHIP R 330 J 1/16W		R139			RK73GB2A180J	CHIP R 18 J 1/10W	
R46			RK73HB1J222J	CHIP R 2.2K J 1/16W		R140			RK73GB2A271J	CHIP R 270 J 1/10W	
R48			RK73HB1J473J	CHIP R 47K J 1/16W		R141			RN73GH1J103D	CHIP R 10K D 1/16W	
R50			RK73HB1J222J	CHIP R 2.2K J 1/16W		R142			RK73PB2H101J	CHIP R 100 J 1/2W	
R53			RK73HB1J560J	CHIP R 56 J 1/16W		R147			RK73EB2E000J	CHIP R 0.0 J 1/4W	
R54,55			RK73HB1J222J	CHIP R 2.2K J 1/16W		R161			RK73HB1J222J	CHIP R 2.2K J 1/16W	
R56,57			RK73HB1J102J	CHIP R 1.0K J 1/16W		R162			RK73HB1J122J	CHIP R 1.2K J 1/16W	
R58			RK73HB1J560J	CHIP R 56 J 1/16W		R163			RK73HB1J682J	CHIP R 6.8K J 1/16W	
R59			RK73HB1J4R7J	CHIP R 4.7 J 1/16W		R164			RK73HB1J470J	CHIP R 47 J 1/16W	
R60,61			RK73HB1J330J	CHIP R 33 J 1/16W		R165			RK73HB1J101J	CHIP R 100 J 1/16W	
R64,65			RK73HB1J222J	CHIP R 2.2K J 1/16W		R166			RK73HB1J222J	CHIP R 2.2K J 1/16W	
R66,67			RK73HB1J104J	CHIP R 100K J 1/16W		R167			RK73HB1J822J	CHIP R 8.2K J 1/16W	
R68			RK73HB1J333D	CHIP R 33K D 1/16W		R168,169			RK73GB2A100J	CHIP R 10 J 1/10W	
R69			RK73HB1J103J	CHIP R 10K J 1/16W		R170			RK73GB2A222J	CHIP R 2.2K J 1/10W	
R72			RK73HB1J102J	CHIP R 1.0K J 1/16W		R171			RK73GB2A470J	CHIP R 47 J 1/10W	
R73			RK73HB1J220J	CHIP R 22 J 1/16W		R172			RK73GB2A271J	CHIP R 270 J 1/10W	
R74			RK73HB1J154J	CHIP R 150K J 1/16W		R173			RK73GB2A180J	CHIP R 18 J 1/10W	
R76			RK73HB1J220J	CHIP R 22 J 1/16W		R174			RK73GB2A271J	CHIP R 270 J 1/10W	
R77			RK73HB1J103J	CHIP R 10K J 1/16W		R175			RN73GH1J103D	CHIP R 10K D 1/16W	
R78			RK73HB1J332J	CHIP R 3.3K J 1/16W		R176			RK73PB2H101J	CHIP R 100 J 1/2W	
R79			RK73HB1J103J	CHIP R 10K J 1/16W		R186			RK73GB2A470J	CHIP R 47 J 1/10W	
R80			RK73HB1J472J	CHIP R 4.7K J 1/16W		R187			RK73HB1J392J	CHIP R 3.9K J 1/16W	
R81			RK73HB1J332J	CHIP R 3.3K J 1/16W		R188			RK73HB1J682J	CHIP R 6.8K J 1/16W	
R82			RK73HB1J682J	CHIP R 6.8K J 1/16W		R189			RK73HB1J273J	CHIP R 27K J 1/16W	
R83			RK73HB1J101J	CHIP R 100 J 1/16W		R190			RK73HB1J394J	CHIP R 390K J 1/16W	
R84			RK73HB1J182J	CHIP R 1.8K J 1/16W		R191			RK73HB1J224J	CHIP R 220K J 1/16W	
R85			RK73HB1J152J	CHIP R 1.5K J 1/16W		R192			RK73HB1J333J	CHIP R 33K J 1/16W	
R86			RK73HB1J391J	CHIP R 390 J 1/16W		R194			RK73HB1J822J	CHIP R 8.2K J 1/16W	
R87			RK73HB1J102J	CHIP R 1.0K J 1/16W		R195,196			RK73HB1J273J	CHIP R 27K J 1/16W	
R88,89			RK73HB1J332J	CHIP R 3.3K J 1/16W		R197			RK73GB2A820J	CHIP R 82 J 1/10W	
R90			RK73HB1J103J	CHIP R 10K J 1/16W		R198,199			RK73GB2A101J	CHIP R 100 J 1/10W	
R91			RK73HB1J102J	CHIP R 1.0K J 1/16W		R200			RK73HB1J103J	CHIP R 10K J 1/16W	
R92			RK73HB1J123J	CHIP R 12K J 1/16W		R201			RK73HB1J822J	CHIP R 8.2K J 1/16W	
R93			RK73HB1J222J	CHIP R 2.2K J 1/16W		R202			RK73HB1J154J	CHIP R 150K J 1/16W	
R94			RK73HB1J474J	CHIP R 470K J 1/16W		R203			RK73HB1J104J	CHIP R 100K J 1/16W	
R95			RK73HB1J153J	CHIP R 15K J 1/16W		R204			RK73GB2A820J	CHIP R 82 J 1/10W	

PARTS LIST

TX-RX UNIT (X57-731X-XX)

Ref. No.	Address	New parts	Parts No.	Description	Desti-nation	Ref. No.	Address	New parts	Parts No.	Description	Desti-nation
R208			RK73HB1J474J	CHIP R 470K J 1/16W		R327,328			RK73HB1J332J	CHIP R 3.3K J 1/16W	
R209			RK73HB1J154J	CHIP R 150K J 1/16W		R329			RK73HB1J000J	CHIP R 0.0 J 1/16W	
R211			R92-3616-05	CARBON RESISTOR (0 OHM)		R330			RK73HB1J104J	CHIP R 100K J 1/16W	
R212			RK73HB1J000J	CHIP R 0.0 J 1/16W		R331,332			RK73HB1J823J	CHIP R 82K J 1/16W	
R213			RK73GB2A562J	CHIP R 5.6K J 1/10W		R333			RK73HB1J222J	CHIP R 2.2K J 1/16W	
R226			RK73HB1J000J	CHIP R 0.0 J 1/16W		R338			RK73HB1J271J	CHIP R 270 J 1/16W	
R227			RK73HB1J332J	CHIP R 3.3K J 1/16W		R339			RK73HB1J390J	CHIP R 39 J 1/16W	
R228			RK73HB1J270J	CHIP R 27 J 1/16W		R340			RK73HB1J104J	CHIP R 100K J 1/16W	
R229			RK73HB1J103J	CHIP R 10K J 1/16W		R341			RK73HB1J823J	CHIP R 82K J 1/16W	
R230			RK73HB1J330J	CHIP R 33 J 1/16W		R342			RK73HB1J333J	CHIP R 33K J 1/16W	
R231-234			RK73HB1J223J	CHIP R 22K J 1/16W		R343			RK73HB1J223J	CHIP R 22K J 1/16W	
R235			RK73HB1J000J	CHIP R 0.0 J 1/16W		R344			RK73HB1J220J	CHIP R 27 J 1/16W	
R236,237			RK73HB1J332J	CHIP R 3.3K J 1/16W		R345			RK73HB1J564J	CHIP R 560K J 1/16W	
R238			RK73HB1J000J	CHIP R 0.0 J 1/16W		R360			RK73HB1J103J	CHIP R 10K J 1/16W	
R239			RK73HB1J104J	CHIP R 100K J 1/16W		R361			RK73HB1J000J	CHIP R 0.0 J 1/16W	
R240,241			RK73HB1J332J	CHIP R 3.3K J 1/16W		R362			RK73HB1J332J	CHIP R 3.3K J 1/16W	
R242			RK73HB1J000J	CHIP R 0.0 J 1/16W		R363			RK73HB1J103J	CHIP R 10K J 1/16W	
R243			RK73HB1J104J	CHIP R 100K J 1/16W		R365			RK73HB1J101J	CHIP R 100 J 1/16W	
R244			RK73HB1J102J	CHIP R 1.0K J 1/16W		R366			RK73HB1J333J	CHIP R 33K J 1/16W	
R251			RK73HB1J151J	CHIP R 150 J 1/16W		R367			RK73HB1J223J	CHIP R 22K J 1/16W	
R252			RK73HB1J120J	CHIP R 12 J 1/16W		R368			RK73HB1J473J	CHIP R 47K J 1/16W	
R253			RK73HB1J104J	CHIP R 100K J 1/16W		R369			RK73HB1J223J	CHIP R 22K J 1/16W	
R255			RK73HB1J333J	CHIP R 33K J 1/16W		R370,371			RK73HB1J000J	CHIP R 0.0 J 1/16W	
R256			RK73HB1J223J	CHIP R 22K J 1/16W		R372			RK73HB1J104J	CHIP R 100K J 1/16W	
R257			RK73HB1J000J	CHIP R 0.0 J 1/16W		R374			RK73HB1J000J	CHIP R 0.0 J 1/16W	
R258,259			RK73HB1J332J	CHIP R 3.3K J 1/16W		R375			RK73HB1J104J	CHIP R 100K J 1/16W	
R260			RK73HB1J000J	CHIP R 0.0 J 1/16W		R376			RK73HB1J152J	CHIP R 1.5K J 1/16W	
R261			RK73HB1J104J	CHIP R 100K J 1/16W		R377			RK73HB1J000J	CHIP R 0.0 J 1/16W	
R262,263			RK73HB1J332J	CHIP R 3.3K J 1/16W		R378			RK73HB1J104J	CHIP R 100K J 1/16W	
R264			RK73HB1J000J	CHIP R 0.0 J 1/16W		R380			RK73HB1J391J	CHIP R 390 J 1/16W	
R265			RK73HB1J104J	CHIP R 100K J 1/16W		R381			RK73HB1J330J	CHIP R 33 J 1/16W	
R266			RK73HB1J222J	CHIP R 2.2K J 1/16W		R382			RK73HB1J104J	CHIP R 100K J 1/16W	
R273			RK73HB1J271J	CHIP R 270 J 1/16W		R384			RK73HB1J153J	CHIP R 15K J 1/16W	
R274			RK73HB1J390J	CHIP R 39 J 1/16W		R385			RK73HB1J103J	CHIP R 10K J 1/16W	
R275,276			RK73HB1J104J	CHIP R 100K J 1/16W		R386			RK73HB1J100J	CHIP R 10 J 1/16W	
R277			RK73HB1J333J	CHIP R 33K J 1/16W		R389			RK73HB1J100J	CHIP R 10 J 1/16W	
R278			RK73HB1J223J	CHIP R 22K J 1/16W		R390			RK73HB1J000J	CHIP R 0.0 J 1/16W	
R291			RK73HB1J000J	CHIP R 0.0 J 1/16W		R391,392			RK73HB1J104J	CHIP R 100K J 1/16W	
R292			RK73HB1J332J	CHIP R 3.3K J 1/16W		R393			RK73HB1J561J	CHIP R 560 J 1/16W	
R293			RK73HB1J103J	CHIP R 10K J 1/16W		R394			RK73HB1J104J	CHIP R 100K J 1/16W	
R294			RK73HB1J102J	CHIP R 1.0K J 1/16W		R396			RK73HB1J471J	CHIP R 470 J 1/16W	
R295			RK73HB1J330J	CHIP R 33 J 1/16W		R397			RK73HB1J330J	CHIP R 33 J 1/16W	
R296-299			RK73HB1J223J	CHIP R 22K J 1/16W		R398,399			RK73HB1J104J	CHIP R 100K J 1/16W	
R300			RK73HB1J000J	CHIP R 0.0 J 1/16W		R400			RK73HB1J333J	CHIP R 33K J 1/16W	
R301,302			RK73HB1J332J	CHIP R 3.3K J 1/16W		R401			RK73HB1J223J	CHIP R 22K J 1/16W	
R303			RK73HB1J000J	CHIP R 0.0 J 1/16W		R405			RK73HB1J103J	CHIP R 10K J 1/16W	
R304			RK73HB1J104J	CHIP R 100K J 1/16W		R406			RK73HB1J000J	CHIP R 0.0 J 1/16W	
R305,306			RK73HB1J332J	CHIP R 3.3K J 1/16W		R407			RK73HB1J332J	CHIP R 3.3K J 1/16W	
R307			RK73HB1J000J	CHIP R 0.0 J 1/16W		R408			RK73HB1J103J	CHIP R 10K J 1/16W	
R308			RK73HB1J104J	CHIP R 100K J 1/16W		R410			RK73HB1J101J	CHIP R 100 J 1/16W	
R316			RK73HB1J151J	CHIP R 150 J 1/16W		R411			RK73HB1J333J	CHIP R 33K J 1/16W	
R317			RK73HB1J120J	CHIP R 12 J 1/16W		R412			RK73HB1J223J	CHIP R 22K J 1/16W	
R318			RK73HB1J104J	CHIP R 100K J 1/16W		R413			RK73HB1J473J	CHIP R 47K J 1/16W	
R319			RK73HB1J564J	CHIP R 560K J 1/16W		R414			RK73HB1J223J	CHIP R 22K J 1/16W	
R320			RK73HB1J333J	CHIP R 33K J 1/16W		R415,416			RK73HB1J000J	CHIP R 0.0 J 1/16W	
R321			RK73HB1J223J	CHIP R 22K J 1/16W		R417			RK73HB1J104J	CHIP R 100K J 1/16W	
R322			RK73HB1J000J	CHIP R 0.0 J 1/16W		R418			RK73HB1J152J	CHIP R 1.5K J 1/16W	
R323,324			RK73HB1J332J	CHIP R 3.3K J 1/16W		R419			RK73HB1J000J	CHIP R 0.0 J 1/16W	
R325			RK73HB1J000J	CHIP R 0.0 J 1/16W		R420			RK73HB1J104J	CHIP R 100K J 1/16W	
R326			RK73HB1J104J	CHIP R 100K J 1/16W		R422			RK73HB1J000J	CHIP R 0.0 J 1/16W	

PARTS LIST

TX-RX UNIT (X57-731X-XX)

Ref. No.	Address	New parts	Parts No.	Description	Destination	Ref. No.	Address	New parts	Parts No.	Description	Destination
R423			RK73HB1J104J	CHIP R 100K J 1/16W		R516			RK73HB1J272J	CHIP R 2.7K J 1/16W	
R425			RK73HB1J391J	CHIP R 390 J 1/16W		R518,519			RK73HB1J103J	CHIP R 10K J 1/16W	
R426			RK73HB1J330J	CHIP R 33 J 1/16W		R521			RK73HB1J103J	CHIP R 10K J 1/16W	
R427			RK73HB1J104J	CHIP R 100K J 1/16W		R522			RK73HB1J221J	CHIP R 220 J 1/16W	
R428			RK73HB1J564J	CHIP R 560K J 1/16W		R523			RK73HB1J330J	CHIP R 33 J 1/16W	
R429			RK73HB1J153J	CHIP R 15K J 1/16W		R524			RK73HB1J102J	CHIP R 1.0K J 1/16W	
R430			RK73HB1J103J	CHIP R 10K J 1/16W		R525			RK73HB1J101J	CHIP R 100 J 1/16W	
R431,432			RK73HB1J100J	CHIP R 10 J 1/16W		R526,527			RK73HB1J104J	CHIP R 100K J 1/16W	
R435			RK73HB1J000J	CHIP R 0.0 J 1/16W		R529			RK73HB1J473J	CHIP R 47K J 1/16W	
R436,437			RK73HB1J104J	CHIP R 100K J 1/16W		R531,532			RK73HB1J104J	CHIP R 100K J 1/16W	
R438			RK73HB1J561J	CHIP R 560 J 1/16W		R533			RK73HB1J391J	CHIP R 390 J 1/16W	
R439			RK73HB1J104J	CHIP R 100K J 1/16W		R534			RK73HB1J102J	CHIP R 1.0K J 1/16W	
R441			RK73HB1J471J	CHIP R 470 J 1/16W		R536			RK73HB1J821J	CHIP R 820 J 1/16W	
R442			RK73HB1J330J	CHIP R 33 J 1/16W		R537			RK73HB1J104J	CHIP R 100K J 1/16W	
R443			RK73HB1J104J	CHIP R 100K J 1/16W		R538			RK73HB1J153J	CHIP R 15K J 1/16W	
R444			RK73HB1J564J	CHIP R 560K J 1/16W		R539			RK73HB1J104J	CHIP R 100K J 1/16W	
R445			RK73HB1J333J	CHIP R 33K J 1/16W		R540			RK73HB1J183J	CHIP R 18K J 1/16W	
R446			RK73HB1J223J	CHIP R 22K J 1/16W		R541			RK73HB1J103J	CHIP R 10K J 1/16W	
R447			RK73HB1J823J	CHIP R 82K J 1/16W		R543			RK73HB1J102J	CHIP R 1.0K J 1/16W	
R457			RK73HB1J332J	CHIP R 3.3K J 1/16W		R544,545			RK73HB1J470J	CHIP R 47 J 1/16W	
R459			RK73HB1J102J	CHIP R 1.0K J 1/16W		R546			RK73HB1J152J	CHIP R 1.5K J 1/16W	
R460			RK73HB1J154J	CHIP R 150K J 1/16W		R547			RK73HB1J103J	CHIP R 10K J 1/16W	
R461			RK73HB1J101J	CHIP R 100 J 1/16W		R548			RK73HB1J474J	CHIP R 470K J 1/16W	
R462			RK73HB1J221J	CHIP R 220 J 1/16W		R549			RK73HB1J101J	CHIP R 100 J 1/16W	
R464			RK73HB1J330J	CHIP R 33 J 1/16W		R550-553			RK73HB1J103J	CHIP R 10K J 1/16W	
R465			RK73HB1J103J	CHIP R 10K J 1/16W		R554,555			RK73HB1J102J	CHIP R 1.0K J 1/16W	
R466			RK73HB1J333J	CHIP R 33K J 1/16W		R556			RK73HB1J103J	CHIP R 10K J 1/16W	
R467			RK73HB1J153J	CHIP R 15K J 1/16W		R557			RK73HB1J820J	CHIP R 82 J 1/16W	
R468			RK73HB1J393J	CHIP R 39K J 1/16W		R558			RK73HB1J220J	CHIP R 22 J 1/16W	
R470			RK73HB1J333J	CHIP R 33K J 1/16W		R559,560			RK73HB1J124J	CHIP R 120K J 1/16W	
R474			RK73HB1J222J	CHIP R 2.2K J 1/16W		R561			RK73HB1J332J	CHIP R 3.3K J 1/16W	
R475			RK73HB1J100J	CHIP R 10 J 1/16W		R562			RK73HB1J102J	CHIP R 1.0K J 1/16W	
R477			RK73HB1J220J	CHIP R 22 J 1/16W		R564			RK73HB1J000J	CHIP R 0.0 J 1/16W	
R478			RK73HB1J102J	CHIP R 1.0K J 1/16W		R565			RK73HB1J182J	CHIP R 1.8K J 1/16W	
R479			RK73HB1J101J	CHIP R 100 J 1/16W		R566			RK73HB1J222J	CHIP R 2.2K J 1/16W	
R480			RK73HB1J104J	CHIP R 100K J 1/16W		R567			RK73HB1J103J	CHIP R 10K J 1/16W	
R481,482			RK73HB1J470J	CHIP R 47 J 1/16W		R568			RK73HB1J102J	CHIP R 1.0K J 1/16W	
R483,484			RK73HB1J151J	CHIP R 150 J 1/16W		R569			RK73HB1J101J	CHIP R 100 J 1/16W	
R486-490			RK73HB1J103J	CHIP R 10K J 1/16W		R570			RK73HB1J104J	CHIP R 100K J 1/16W	
R491,492			RK73HB1J102J	CHIP R 1.0K J 1/16W		R572			RK73HB1J391J	CHIP R 390 J 1/16W	
R494			RK73HB1J220J	CHIP R 22 J 1/16W		R573			RK73HB1J821J	CHIP R 820 J 1/16W	
R495			RK73HB1J820J	CHIP R 82 J 1/16W		R574			RK73HB1J103J	CHIP R 10K J 1/16W	
R496			RK73HB1J472J	CHIP R 4.7K J 1/16W		R575			RK73HB1J472J	CHIP R 4.7K J 1/16W	
R497			RK73HB1J562J	CHIP R 5.6K J 1/16W		R576,577			RK73HB1J103J	CHIP R 10K J 1/16W	
R498			RK73HB1J124J	CHIP R 120K J 1/16W		R578,579			RK73HB1J182J	CHIP R 1.8K J 1/16W	
R499			RK73HB1J562J	CHIP R 5.6K J 1/16W		R580			RK73EB2E102J	CHIP R 1.0K J 1/4W	
R500			RK73HB1J124J	CHIP R 120K J 1/16W		R581			RK73HB1J103J	CHIP R 10K J 1/16W	
R501			RK73HB1J332J	CHIP R 3.3K J 1/16W		R582			RK73EB2E102J	CHIP R 1.0K J 1/4W	
R502			RK73HB1J103J	CHIP R 10K J 1/16W		R583,584			RK73HB1J223J	CHIP R 22K J 1/16W	
R504			RK73HB1J000J	CHIP R 0.0 J 1/16W		R587			RK73HB1J000J	CHIP R 0.0 J 1/16W	
R505			RK73HB1J334J	CHIP R 330K J 1/16W		R588-591			RK73HB1J103J	CHIP R 10K J 1/16W	
R506			RK73HB1J101J	CHIP R 100 J 1/16W		R606			RK73HB1J562J	CHIP R 5.6K J 1/16W	
R507			RK73HB1J102J	CHIP R 1.0K J 1/16W		R608			RK73HB1J153J	CHIP R 15K J 1/16W	
R508			RK73HB1J561J	CHIP R 560 J 1/16W		R611,612			RK73HB1J224J	CHIP R 220K J 1/16W	
R510			RK73HB1J334J	CHIP R 330K J 1/16W		R615			RK73HB1J102J	CHIP R 1.0K J 1/16W	
R511			RK73HB1J103J	CHIP R 10K J 1/16W		R616			RK73HB1J472J	CHIP R 4.7K J 1/16W	
R512			RK73HB1J182J	CHIP R 1.8K J 1/16W		R617,618			RK73HB1J102J	CHIP R 1.0K J 1/16W	
R513			RK73HB1J101J	CHIP R 100 J 1/16W		R619			RK73HB1J103J	CHIP R 10K J 1/16W	
R514			RK73HB1J102J	CHIP R 1.0K J 1/16W		R620			RK73GB2A100J	CHIP R 10 J 1/10W	
R515			RK73HB1J561J	CHIP R 560 J 1/16W		R621-623			RK73HB1J102J	CHIP R 1.0K J 1/16W	

PARTS LIST

TX-RX UNIT (X57-731X-XX)

Ref. No.	Address	New parts	Parts No.	Description	Desti-nation	Ref. No.	Address	New parts	Parts No.	Description	Desti-nation
R624			RK73HB1J104J	CHIP R 100K J 1/16W		R764			RK73HB1J473J	CHIP R 47K J 1/16W	
R625			RK73HB1J103J	CHIP R 10K J 1/16W		R765,766			RK73HB1J222J	CHIP R 2.2K J 1/16W	
R626,627			RK73HB1J104J	CHIP R 100K J 1/16W		R767			RK73HB1J473J	CHIP R 47K J 1/16W	
R635,636			RK73HB1J101J	CHIP R 100 J 1/16W		R770			RK73GB2A000J	CHIP R 0.0 J 1/10W	
R641			RK73EB2E105J	CHIP R 1.0M J 1/4W		R771,772			RK73HB1J681J	CHIP R 680 J 1/16W	
R644			RK73EB2E104J	CHIP R 100K J 1/4W		R773			RK73HB1J331J	CHIP R 330 J 1/16W	
R646			RK73RB2H220J	CHIP R 22 J 1/2W		R774			RK73HB1J151J	CHIP R 150 J 1/16W	
R647			RK73HB1J103J	CHIP R 10K J 1/16W		R775			RK73HB1J470J	CHIP R 47 J 1/16W	
R648			RK73HB1J102J	CHIP R 1.0K J 1/16W		R776			RK73HB1J103J	CHIP R 10K J 1/16W	
R649			RK73HB1J154J	CHIP R 150K J 1/16W		R777			RK73HB1J392J	CHIP R 3.9K J 1/16W	
R650,651			RK73HB1J223J	CHIP R 22K J 1/16W		R778			RK73HB1J101J	CHIP R 100 J 1/16W	
R652			RK73HB1J222J	CHIP R 2.2K J 1/16W		R780			RK73HB1J330J	CHIP R 33 J 1/16W	
R654			RK73GB2A000J	CHIP R 0.0 J 1/10W	K	R803			RK73GB2A104J	CHIP R 100K J 1/10W	
R656			RK73GB2A000J	CHIP R 0.0 J 1/10W	K,M4	R804			RK73GB2A222J	CHIP R 2.2K J 1/10W	
R657			RK73HB1J473J	CHIP R 47K J 1/16W		R805			RK73HB1J563J	CHIP R 56K J 1/16W	
R658			RK73GB2A000J	CHIP R 0.0 J 1/10W	E	R806			RK73HB1J821J	CHIP R 820 J 1/16W	
R659			RK73HB1J473J	CHIP R 47K J 1/16W		R809			RK73HB1J101J	CHIP R 100 J 1/16W	
R663,664			RK73GB2A000J	CHIP R 0.0 J 1/10W		R810			RK73HB1J103J	CHIP R 10K J 1/16W	
R665			RK73HB1J473J	CHIP R 47K J 1/16W		R811			RK73HB1J105J	CHIP R 1.0M J 1/16W	
R672			RK73HB1J473J	CHIP R 47K J 1/16W		R812			RK73GB2A391J	CHIP R 390 J 1/10W	
R684			RK73HB1J332J	CHIP R 3.3K J 1/16W		R813			RK73HB1J472J	CHIP R 4.7K J 1/16W	
R685			RK73HB1J221J	CHIP R 220 J 1/16W		R814,815			RK73HB1J333J	CHIP R 33K J 1/16W	
R689			RK73HB1J000J	CHIP R 0.0 J 1/16W		R816			RK73HB1J562J	CHIP R 5.6K J 1/16W	
R690			RK73HB1J682J	CHIP R 6.8K J 1/16W		R817,818			RK73HB1J333J	CHIP R 33K J 1/16W	
R691			RK73HB1J122J	CHIP R 1.2K J 1/16W		R819			RK73HB1J473J	CHIP R 47K J 1/16W	
R692			RK73HB1J470J	CHIP R 47 J 1/16W		R820,821			RK73HB1J103J	CHIP R 10K J 1/16W	
R693			RK73HB1J101J	CHIP R 100 J 1/16W		R822			RK73HB1J473J	CHIP R 47K J 1/16W	
R695			RK73HB1J332J	CHIP R 3.3K J 1/16W		R823			RK73HB1J152J	CHIP R 1.5K J 1/16W	
R696			RK73HB1J000J	CHIP R 0.0 J 1/16W		R825			RK73HB1J822J	CHIP R 8.2K J 1/16W	
R697			RK73GB2A000J	CHIP R 0.0 J 1/10W		R826			RK73HB1J473J	CHIP R 47K J 1/16W	
R701,702			RK73HB1J000J	CHIP R 0.0 J 1/16W		R827			RK73HB1J472J	CHIP R 4.7K J 1/16W	
R703			RK73HB1J102J	CHIP R 1.0K J 1/16W		R828			RK73HB1J473J	CHIP R 47K J 1/16W	
R704			RK73GB2A000J	CHIP R 0.0 J 1/10W		R829			RK73GB2A185J	CHIP R 1.8M J 1/10W	
R705			RK73HB1J474J	CHIP R 470K J 1/16W		R830			RK73HB1J330J	CHIP R 33 J 1/16W	
R706,707			RK73HB1J473J	CHIP R 47K J 1/16W		R831			RK73HB1J103J	CHIP R 10K J 1/16W	
R708,709			RK73HB1J153J	CHIP R 15K J 1/16W		R832,833			RK73HB1J683J	CHIP R 68K J 1/16W	
R710			RK73HB1J474J	CHIP R 470K J 1/16W		R836,837			RK73HB1J472J	CHIP R 4.7K J 1/16W	
R711			RK73FB2B000J	CHIP R 0.0 J 1/8W		R838			RK73HB1J392J	CHIP R 3.9K J 1/16W	
R713			RK73HB1J104J	CHIP R 100K J 1/16W		R839,840			RK73HB1J473J	CHIP R 47K J 1/16W	
R714			RK73HB1J473J	CHIP R 47K J 1/16W		R841			RK73HB1J471J	CHIP R 470 J 1/16W	
R715,716			RK73HB1J222J	CHIP R 2.2K J 1/16W		R842			RK73HB1J472J	CHIP R 4.7K J 1/16W	
R717			RK73HB1J473J	CHIP R 47K J 1/16W		R843			RK73HB1J471J	CHIP R 470 J 1/16W	
R720			RK73GB2A000J	CHIP R 0.0 J 1/10W		R844			RK73HB1J472J	CHIP R 4.7K J 1/16W	
R721,722			RK73HB1J681J	CHIP R 680 J 1/16W		R845,846			RK73HB1J684J	CHIP R 680K J 1/16W	
R723			RK73HB1J331J	CHIP R 330 J 1/16W		R847			RK73HB1J104J	CHIP R 100K J 1/16W	
R724			RK73HB1J151J	CHIP R 150 J 1/16W		R848			RK73GB2A185J	CHIP R 1.8M J 1/10W	
R725			RK73HB1J470J	CHIP R 47 J 1/16W		R849,850			RK73HB1J273J	CHIP R 27K J 1/16W	
R726			RK73HB1J103J	CHIP R 10K J 1/16W		R851			RK73HB1J103J	CHIP R 10K J 1/16W	
R727			RK73HB1J392J	CHIP R 3.9K J 1/16W		R852			RK73HB1J330J	CHIP R 33 J 1/16W	
R728			RK73HB1J101J	CHIP R 100 J 1/16W		R853			RK73GB2A185J	CHIP R 1.8M J 1/10W	
R730			RK73HB1J330J	CHIP R 33 J 1/16W		R854,855			RK73HB1J330J	CHIP R 33 J 1/16W	
R751,752			RK73HB1J000J	CHIP R 0.0 J 1/16W		R856			RK73HB1J473J	CHIP R 47K J 1/16W	
R753			RK73HB1J102J	CHIP R 1.0K J 1/16W		R857			RK73HB1J103J	CHIP R 10K J 1/16W	
R754			RK73GB2A000J	CHIP R 0.0 J 1/10W		R858			RK73HB1J102J	CHIP R 1.0K J 1/16W	
R755			RK73HB1J474J	CHIP R 470K J 1/16W		R859			RK73HB1J103J	CHIP R 10K J 1/16W	
R756,757			RK73HB1J473J	CHIP R 47K J 1/16W		R860			RK73HB1J102J	CHIP R 1.0K J 1/16W	
R758,759			RK73HB1J153J	CHIP R 15K J 1/16W		R861,862			RK73HB1J824J	CHIP R 820K J 1/16W	
R760			RK73HB1J474J	CHIP R 470K J 1/16W		R863			RK73HB1J473J	CHIP R 47K J 1/16W	
R761			RK73FB2B000J	CHIP R 0.0 J 1/8W		R866-868			RK73HB1J104J	CHIP R 100K J 1/16W	
R763			RK73HB1J104J	CHIP R 100K J 1/16W		R869			RK73HB1J563J	CHIP R 56K J 1/16W	

PARTS LIST

TX-RX UNIT (X57-731X-XX)

Ref. No.	Address	New parts	Parts No.	Description	Destination	Ref. No.	Address	New parts	Parts No.	Description	Destination
R870			RK73HB1J473J	CHIP R 47K J 1/16W		R992			RK73HB1J274J	CHIP R 270K J 1/16W	
R871			RK73GB2A185J	CHIP R 1.8M J 1/10W		R993			RK73HB1J103J	CHIP R 10K J 1/16W	
R872			RK73HB1J102J	CHIP R 1.0K J 1/16W		R994			RK73EB2E102J	CHIP R 1.0K J 1/4W	
R874			RK73HB1J103J	CHIP R 10K J 1/16W		R995			RK73HB1J332J	CHIP R 3.3K J 1/16W	
R875,876			RK73HB1J124J	CHIP R 120K J 1/16W		R996			RK73HB1J223J	CHIP R 22K J 1/16W	
R877			RK73HB1J334J	CHIP R 330K J 1/16W		R997			RK73HB1J183J	CHIP R 18K J 1/16W	
R878,879			RK73HB1J103J	CHIP R 10K J 1/16W		R998,999			RK73HB1J000J	CHIP R 0.0 J 1/16W	
R880			RK73HB1J224J	CHIP R 220K J 1/16W		D1			1SS400	DIODE	
R882			RK73HB1J564J	CHIP R 560K J 1/16W		D2			DA221	DIODE	
R883			RK73HB1J101J	CHIP R 100 J 1/16W		D3,4			1SS400	DIODE	
R884			RK73HB1J124J	CHIP R 120K J 1/16W		D5,6			MA2S077-F	DIODE	
R885			RK73HB1J394J	CHIP R 390K J 1/16W		D10-13			HSC277	DIODE	
R886,887			RK73HB1J103J	CHIP R 10K J 1/16W		D14-19			HVC131	DIODE	
R888			RK73HB1J124J	CHIP R 120K J 1/16W		D20,21			HSC277	DIODE	
R889,890			RK73HB1J103J	CHIP R 10K J 1/16W		D22-29			HVC131	DIODE	
R891			RK73HB1J223J	CHIP R 22K J 1/16W		D30-35			HSC277	DIODE	
R892			RK73HB1J563J	CHIP R 56K J 1/16W		D66			1SS400	DIODE	
R906			RK73HB1J332J	CHIP R 3.3K J 1/16W		D67			DA221	DIODE	
R908-910			RK73HB1J103J	CHIP R 10K J 1/16W		D68,69			1SS400	DIODE	
R911			RK73HB1J224J	CHIP R 220K J 1/16W		D70,71			MA2S077-F	DIODE	
R912,913			RK73HB1J562J	CHIP R 5.6K J 1/16W		D130,131			HVC131	DIODE	
R916			RK73HB1J473J	CHIP R 47K J 1/16W		D132			1SS355	DIODE	
R917,918			RK73HB1J000J	CHIP R 0.0 J 1/16W		D133			EDZ5.1B	ZENER DIODE	
R919			RK73HB1J473J	CHIP R 47K J 1/16W		D134,135			L407CDB	DIODE (50V/1W)	
R920			RK73HB1J000J	CHIP R 0.0 J 1/16W		D136			1SS355	DIODE	
R921-923			RK73HB1J473J	CHIP R 47K J 1/16W		D160,161			HVC131	DIODE	
R924			RK73HB1J104J	CHIP R 100K J 1/16W		D162			1SS355	DIODE	
R925			RK73HB1J223J	CHIP R 22K J 1/16W		D163			EDZ5.1B	ZENER DIODE	
R927			RK73HB1J473J	CHIP R 47K J 1/16W		D164,165			L407CDB	DIODE (50V/1W)	
R928			RK73HB1J823J	CHIP R 82K J 1/16W		D166			1SS355	DIODE	
R930			RK73HB1J473J	CHIP R 47K J 1/16W		D186,187			MA4PH633	DIODE	
R931			RK73HB1J000J	CHIP R 0.0 J 1/16W		D188,189			HVU131-E	DIODE	
R932			RK73HB1J473J	CHIP R 47K J 1/16W		D190			1SS400	DIODE	
R934-939			RK73HB1J473J	CHIP R 47K J 1/16W		D191,192			MA3J742	DIODE	
R940			RK73GB2A821J	CHIP R 820 J 1/10W		D193			EDZ5.1B	ZENER DIODE	
R942,943			RK73HB1J334J	CHIP R 330K J 1/16W		D226,227			HSC277	DIODE	
R944			RK73HB1J183J	CHIP R 18K J 1/16W		D229			HSC277	DIODE	
R945			RK73HB1J153J	CHIP R 15K J 1/16W		D230,231			1SV325F	VARIABLE CAPACITANCE DIODE	
R946			RK73HB1J473J	CHIP R 47K J 1/16W		D232			HSC277	DIODE	
R950			RK73HB1J102J	CHIP R 1.0K J 1/16W		D233,234			1SV325F	VARIABLE CAPACITANCE DIODE	
R951,952			RK73HB1J000J	CHIP R 0.0 J 1/16W		D238			HSC277	DIODE	
R953			RK73HB1J102J	CHIP R 1.0K J 1/16W		D239,240			1SV325F	VARIABLE CAPACITANCE DIODE	
R954,955			RK73HB1J000J	CHIP R 0.0 J 1/16W		D241			HSC277	DIODE	
R956			RK73HB1J102J	CHIP R 1.0K J 1/16W		D242,243			1SV325F	VARIABLE CAPACITANCE DIODE	
R957-963			RK73HB1J000J	CHIP R 0.0 J 1/16W		D291,292			HSC277	DIODE	
R965			RK73FB2B122J	CHIP R 1.2K J 1/8W		D294			HSC277	DIODE	
R967			RK73GB2A000J	CHIP R 0.0 J 1/10W	M4	D295,296			1SV325F	VARIABLE CAPACITANCE DIODE	
R968			RK73FB2B122J	CHIP R 1.2K J 1/8W		D297			HSC277	DIODE	
R969			RK73EB2E000J	CHIP R 0.0 J 1/4W		D298,299			1SV325F	VARIABLE CAPACITANCE DIODE	
R971			RK73GB2A000J	CHIP R 0.0 J 1/10W	E	D303			HSC277	DIODE	
R979			RK73HB1J682J	CHIP R 6.8K J 1/16W		D304,305			1SV325F	VARIABLE CAPACITANCE DIODE	
R980			RK73HB1J000J	CHIP R 0.0 J 1/16W		D306			HSC277	DIODE	
R981			RK73FB2B330J	CHIP R 33 J 1/8W		D307,308			1SV325F	VARIABLE CAPACITANCE DIODE	
R982			RK73HB1J102J	CHIP R 1.0K J 1/16W		D356			HVC131	DIODE	
R983			RK73HB1J101J	CHIP R 100 J 1/16W		D361-363			HSC277	DIODE	
R984			RK73HB1J102J	CHIP R 1.0K J 1/16W		D364,365			BBY65-02V	VARIABLE CAPACITANCE DIODE	
R985,986			RK73HB1J000J	CHIP R 0.0 J 1/16W		D367,368			BBY65-02V	VARIABLE CAPACITANCE DIODE	
R987			RK73EB2E000J	CHIP R 0.0 J 1/4W		D370,371			BBY65-02V	VARIABLE CAPACITANCE DIODE	
R990			RK73EB2E102J	CHIP R 1.0K J 1/4W		D375,376			BBY65-02V	VARIABLE CAPACITANCE DIODE	
R991			RK73HB1J104J	CHIP R 100K J 1/16W							

PARTS LIST

TX-RX UNIT (X57-731X-XX)

Ref. No.	Address	New parts	Parts No.	Description	Destination	Ref. No.	Address	New parts	Parts No.	Description	Destination
D377			BBY53-05W	VARIABLE CAPACITANCE DIODE		IC666			BU4053BCFV	MOS-IC	
D378,379			BBY65-02V	VARIABLE CAPACITANCE DIODE		IC667			BH2228FV	MOS-IC	
D406-408			HSC277	DIODE		IC668			TA4002F-F	BI-POLAR IC	
D409,410			BBY65-02V	VARIABLE CAPACITANCE DIODE		IC801	2B		LA4629	MOS-IC	
D412,413			BBY65-02V	VARIABLE CAPACITANCE DIODE		IC802,803			NJM2100V-ZB	MOS-IC	
D415,416			BBY65-02V	VARIABLE CAPACITANCE DIODE		IC804			M62364FP-F	MOS-IC	
D419			BBY53-05W	VARIABLE CAPACITANCE DIODE		IC805			NJM2112V-ZB	MOS-IC	
D420,421			BBY65-02V	VARIABLE CAPACITANCE DIODE		IC806			BU8241FS	MOS-IC	
D423,424			BBY65-02V	VARIABLE CAPACITANCE DIODE		IC807			TC7W66FK-F	MOS-IC	
D451			HVC131	DIODE		IC916			AT25256A10TU27	ROM IC	
D456			HSC277	DIODE		IC917			TC4W53FU-F	MOS-IC	
D457			HVC131	DIODE		IC918		*	3062LFGPUKBVE	MICROPROCESSOR IC	K
D486,487			DAN235E	DIODE		IC918		*	3062LFGPUKBWE	MICROPROCESSOR IC	E,M4
D488			RB706F-40	DIODE		IC919,920			BD4840FVE	MOS-IC	
D489			HSC277	DIODE		IC921			LC73881M-E	MOS-IC	
D546,547			DAN235E	DIODE		IC951			TC74HC4050AFT	MOS-IC	
D576			DAN222	DIODE		IC952	3B		BAJ0CC0T	BI-POLAR IC	
D578			1SS400	DIODE		IC953			TA7805FQ	MOS-IC	
D580			DAN222	DIODE		Q1			2SC4617(R)	TRANSISTOR	
D582,583			DAN222	DIODE		Q2			2SA1774(R)	TRANSISTOR	
D584			DAP202K	DIODE		Q3,4			2SC4617(R)	TRANSISTOR	
D606			1SS400	DIODE		Q5			2SC5636	TRANSISTOR	
D607			DA221	DIODE		Q6			DTC144EE	DIGITAL TRANSISTOR	
D608			1SS400	DIODE		Q7			2SC5636	TRANSISTOR	
D609			DA221	DIODE		Q8,9			DTC144EE	DIGITAL TRANSISTOR	
D610,611			DSM3MA1-RPB	DIODE		Q66			2SC4617(R)	TRANSISTOR	
D612			22ZR-10D	SURGE ABSORBER		Q67			2SA1774(R)	TRANSISTOR	
D701			HSC277	DIODE		Q68,69			2SC4617(R)	TRANSISTOR	
D703-705			1SV325F	VARIABLE CAPACITANCE DIODE		Q70			2SC5636	TRANSISTOR	
D707			1SV325F	VARIABLE CAPACITANCE DIODE		Q71			DTC144EE	DIGITAL TRANSISTOR	
D708			HSC277	DIODE		Q72			2SC5636	TRANSISTOR	
D709			1SV323F	VARIABLE CAPACITANCE DIODE		Q73,74			DTC144EE	DIGITAL TRANSISTOR	
D710			1SV278F	VARIABLE CAPACITANCE DIODE		Q131			2SC3357-A(RF)	TRANSISTOR	
D751			HSC277	DIODE		Q132			2SK1830F	FET	
D753-755			1SV325F	VARIABLE CAPACITANCE DIODE		Q161			2SC3356-A(R24)	TRANSISTOR	
D757			1SV325F	VARIABLE CAPACITANCE DIODE		Q162			2SC3357-A(RF)	TRANSISTOR	
D758			HSC277	DIODE		Q163			2SK1830F	FET	
D759			1SV323F	VARIABLE CAPACITANCE DIODE		Q186			DTC144EE	DIGITAL TRANSISTOR	
D760			1SV278F	VARIABLE CAPACITANCE DIODE		Q226,227			3SK294-FP	FET	
D801			DAN222	DIODE		Q228			3SK318	FET	
D802			1SS372F	DIODE		Q229			DTC144EE	DIGITAL TRANSISTOR	
D916			02DZ18F-X,Y	ZENER DIODE		Q291,292			3SK294-FP	FET	
D951-953			DA221	DIODE		Q293			3SK318	FET	
D954			1SS355	DIODE		Q294			DTC144EE	DIGITAL TRANSISTOR	
D955			EDZ5.1B	ZENER DIODE		Q361			3SK294-FP	FET	
D956			MINISMDC110F16	VARISTOR		Q362,363			3SK318	FET	
D957			1SR154-400	DIODE		Q400			DTC144EE	DIGITAL TRANSISTOR	
IC1			MB15A02PFV2E1	MOS-IC		Q406			3SK294-FP	FET	
IC66			MB15A02PFV2E1	MOS-IC		Q407,408			3SK318	FET	
IC131	2B		RA60H13171123	MOS-IC		Q450			DTC144EE	DIGITAL TRANSISTOR	
IC161	2B		RA60H40471101	MOS-IC		Q456			2SC5636	TRANSISTOR	
IC186			TC7W66FK-F	MOS-IC		Q457			3SK318	FET	
IC187			NJM2904V-ZB	MOS-IC		Q459			2SC5066-F(O)	TRANSISTOR	
IC486			TA31136FNG	MOS-IC		Q486-488			2SK1830F	FET	
IC487			TC75W51FUF	MOS-IC		Q489			2SC4617(R)	TRANSISTOR	
IC546			TA31136FNG	MOS-IC		Q490			2SK1830F	FET	
IC576,577			BU2099FV	MOS-IC		Q491			2SC4617(R)	TRANSISTOR	
IC578	2B		KIA7808API	MOS-IC		Q492			2SK1830F	FET	
IC579			TA7805FQ	MOS-IC		Q493			DTA114EUA	DIGITAL TRANSISTOR	
IC606			ADM202EARUZ	MOS-IC		Q494			2SC4617(R)	TRANSISTOR	

If a part reference number is listed in a shaded box, that part does not come with the PCB.

TM-D710A/D710E

PARTS LIST

TX-RX UNIT (X57-731X-XX)

Ref. No.	Address	New parts	Parts No.	Description	Destination	Ref. No.	Address	New parts	Parts No.	Description	Destination
Q495			2SC5636	TRANSISTOR							
Q496			2SK1830F	FET							
Q546			2SK1830F	FET							
Q547			2SC4649(N,P)	TRANSISTOR							
Q548,549			2SK1830F	FET							
Q550			DTA114EUA	DIGITAL TRANSISTOR							
Q551			2SC5636	TRANSISTOR							
Q572			DTA114EE	DIGITAL TRANSISTOR							
Q573			2SK1830F	FET							
Q574			DTA114EE	DIGITAL TRANSISTOR							
Q575			2SK1830F	FET							
Q576			DTA123JUA	DIGITAL TRANSISTOR							
Q578-580			DTA123JUA	DIGITAL TRANSISTOR							
Q582-584			DTA123JUA	DIGITAL TRANSISTOR							
Q585,586			12A02CH	TRANSISTOR							
Q587-590			DTA123JUA	DIGITAL TRANSISTOR							
Q591			DTC144EE	DIGITAL TRANSISTOR							
Q592			CPH6122	TRANSISTOR							
Q606,607			2SC4617(R)	TRANSISTOR							
Q641			2SC4617(R)	TRANSISTOR							
Q642			DTC144EE	DIGITAL TRANSISTOR							
Q644			2SC3356-A(R24)	TRANSISTOR							
Q701,702			DTC114YE	DIGITAL TRANSISTOR							
Q703			SSM6L05FU-F	FET							
Q704			2SJ347F	FET							
Q705,706			2SK508NV(K52)	FET							
Q707			2SC5108(YF)	TRANSISTOR							
Q751,752			DTC114YE	DIGITAL TRANSISTOR							
Q753			SSM6L05FU-F	FET							
Q754			2SJ347F	FET							
Q755,756			2SK508NV(K52)	FET							
Q757			2SC5108(YF)	TRANSISTOR							
Q801			2SC4919	TRANSISTOR							
Q802			KRC102S-P	DIGITAL TRANSISTOR							
Q803,804			DTC363EU	DIGITAL TRANSISTOR							
Q805			2SC4617(S)	TRANSISTOR							
Q806,807			2SC4617(R)	TRANSISTOR							
Q808			2SC4617(S)	TRANSISTOR							
Q809			2SK1830F	FET							
Q810,811			2SC4617(R)	TRANSISTOR							
Q812			2SK1830F	FET							
Q816			DTC363EU	DIGITAL TRANSISTOR							
Q817			2SK1824-A	FET							
Q916-918			DTC144EE	DIGITAL TRANSISTOR							
Q951,952			DTC144EE	DIGITAL TRANSISTOR							
Q953			CPH6122	TRANSISTOR							
Q954			DTA123JUA	DIGITAL TRANSISTOR							
Q955			2SC4617(R)	TRANSISTOR							
TH102,103			NCP18XH103J0S	THERMISTOR							
TH131			NCP18XH103F0S	THERMISTOR							
TH161			NCP18XH103F0S	THERMISTOR							
TH485,486			NCP18XQ102J0S	THERMISTOR							
TH545,546			NCP18XQ102J0S	THERMISTOR							
-			X57-7310-61	VCO PCB (SERVICE)							

EXPLODED VIEW

- | | | | |
|---|------------------|---|-------------|
| A | M3 x 20 | : | N09-6548-05 |
| B | 2 x 18 | : | N09-6555-05 |
| C | | : | N14-0830-14 |
| D | | : | N14-0845-04 |
| E | M2.6 x 6 (OC) | : | N33-2606-43 |
| F | M3 x 8 | : | N67-3008-48 |
| G | 2 x 8 | : | N80-2008-48 |
| H | 2.6 x 6 (Br-Tap) | : | N87-2606-48 |
| J | 2.6 x 6 (Bi-Tap) | : | N89-2606-43 |

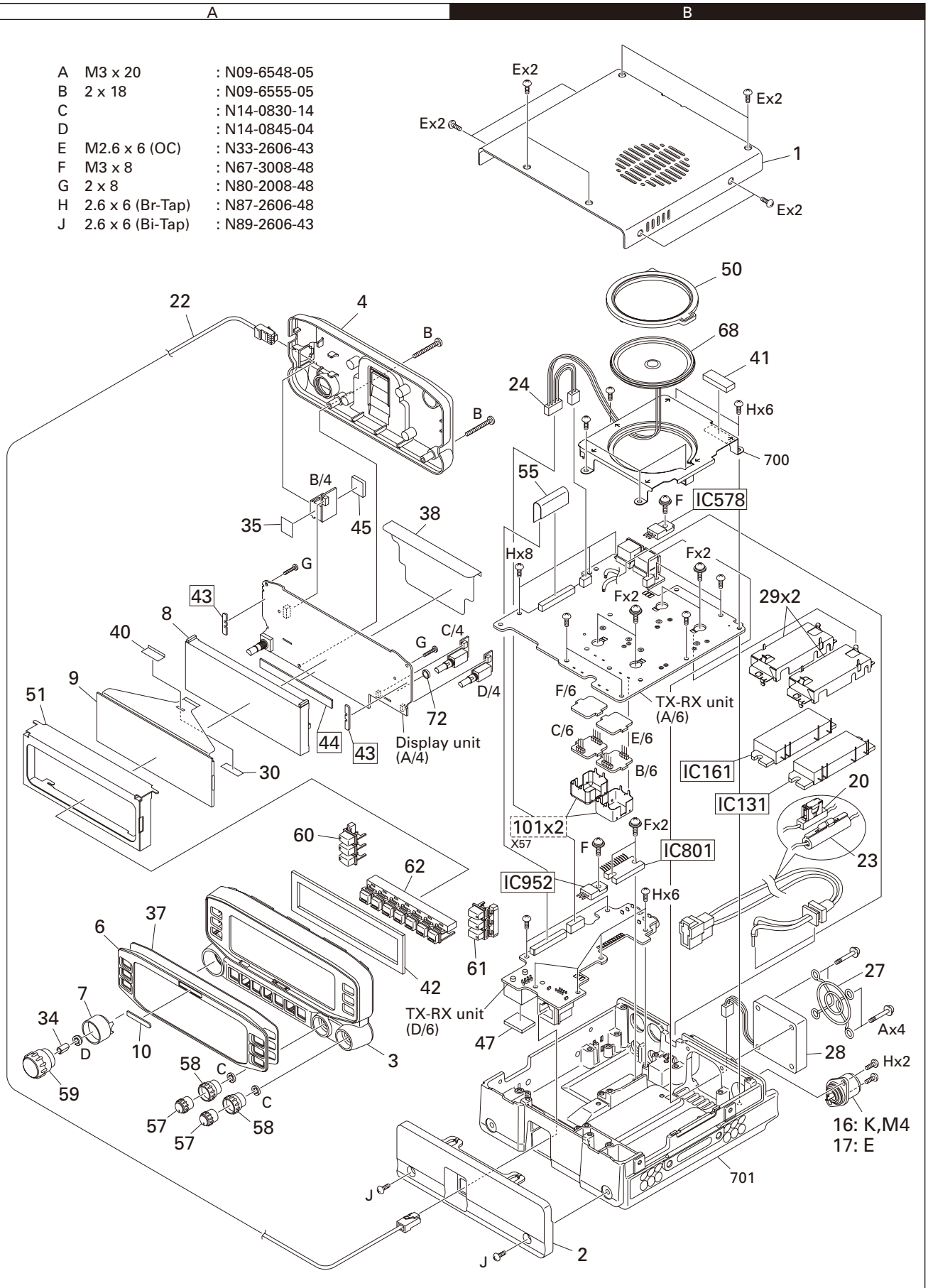

Parts with the exploded numbers larger than 700 are not supplied.

If a part reference number is listed in a box on the exploded view of the PCB, that part does not come with the PCB. These parts must be ordered separately.

PACKING

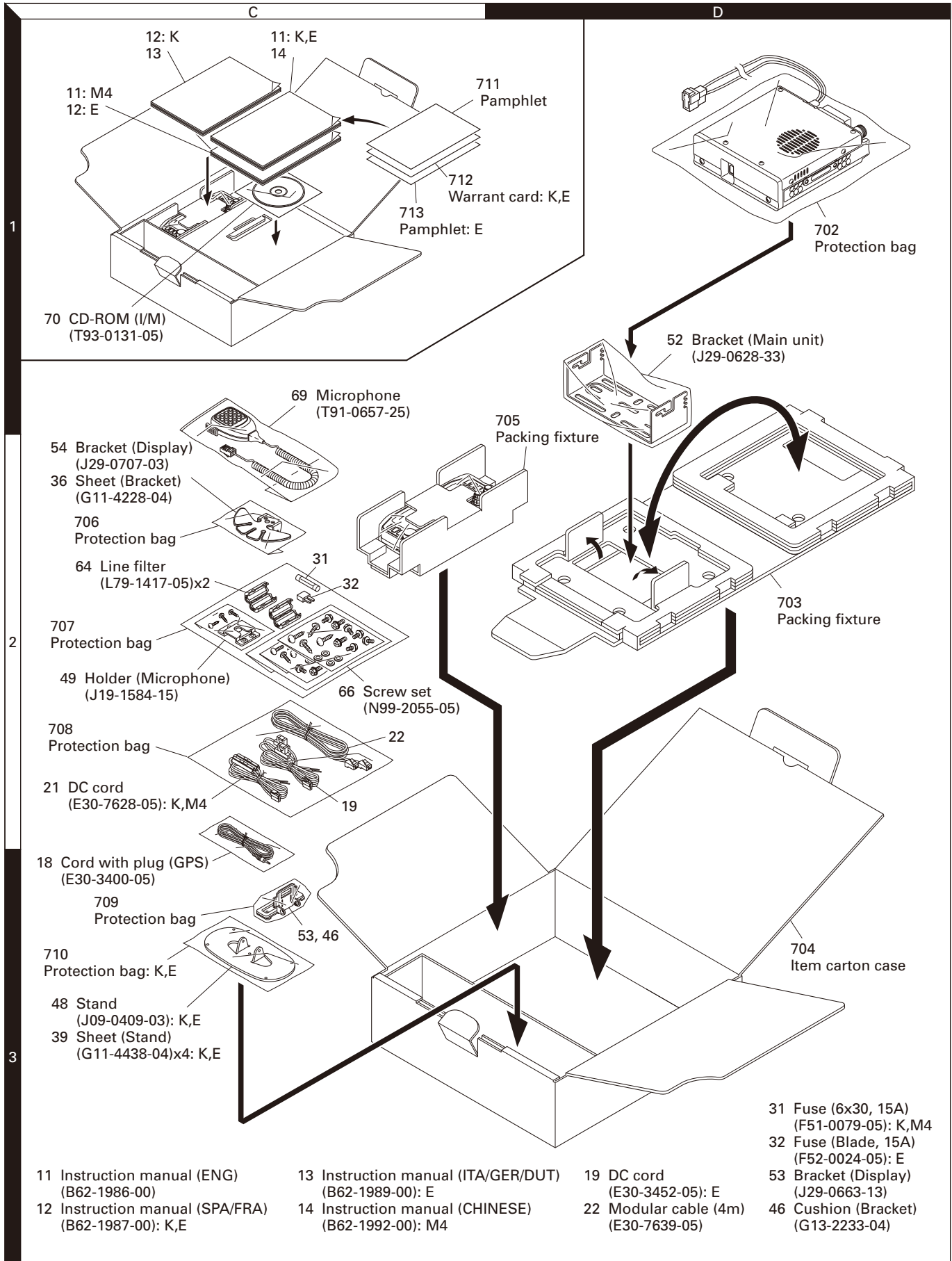

ADJUSTMENT

EchoLink Operation Check Method

You can confirm whether the terminal for EchoLink operates normally by performing the following three operation checks.

1. Squelch signal operation check
2. PTT signal operation check
3. Voice operation check

■ Operation procedure

- 1) Connect the serial communications cable (8-pin mini DIN terminal and D-SUB terminal) of the PG-5H (PC interface cable kit) to the PC terminal on the rear of the transceiver.
- 2) Turn the transceiver power ON while pressing the [PF2] key, to enter the EchoLink Sysop mode.
- 3) Check the squelch signal operation.
 - ① The squelch signal is output from pin 1 of the transceiver PC terminal or pin 8 of the PG-5H D-SUB terminal (RTS). Check the voltage of the RTS line with a digital voltmeter.

Terminal name	PC terminal of the transceiver	D-SUB terminal of PG-5H
RTS	pin 1	pin 8
CTS	pin 2	pin 7

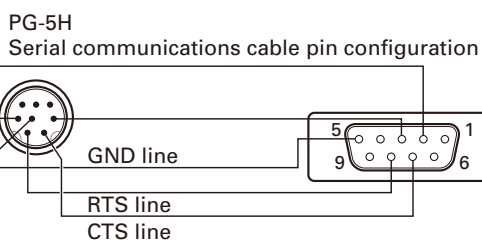

- ② When you open and close the transceiver squelch, check that the voltage of the RTS line increases and decreases.
(Reference voltage value of RTS line)
Voltage when squelch is closed: 10 V
Voltage when squelch is opened : -10 V

- 4) Check the PTT signal operation.
 - ① Input 5 to 10 V to pin 2 of the transceiver PC terminal or pin 7 of the PG-5H D-SUB terminal (CTS).
 - ② Ensure that the transceiver becomes the transmission state.
- 5) Check the voice operation.
 - ① Connect the data communications cable (6-pin mini DIN terminal and pink/ green pin) of the PG-5H (Interface cable kit) to the DATA terminal on the rear of the transceiver.
 - ② Input a 1kHz/ 150 mV AF signal from AG to the green pin of the data communication cable (PKD line). Confirm the modulation of 2 to 4 kHz deviation hangs when transmitting by PTT operation as stated in step 4), above.
 - ③ Input a standard modulation signal of -47dBm (MOD: 1kHz, DEV: 3kHz) from SSG to the transceiver.

Check that a 1kHz tone of 3 to 15 mV is output from the pink pin (PR1 line) of the data communication cable.

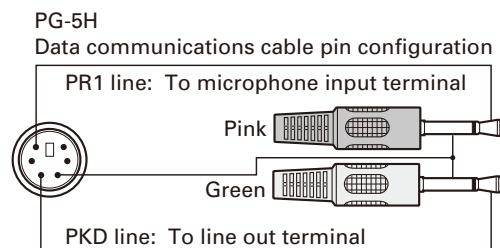

Main MPU/Panel MPU/TNC MPU Version Check Method

■ Main MPU/Panel MPU version check method

You can confirm the Main MPU and Panel MPU versions of the transceiver using its panel keys.

When confirming the version, use normal mode.

When confirming the version in APRS mode or packet mode and the beacon is transmitted, the version display is cancelled.

• Operation procedure

- 1) Turn the transceiver power OFF.
- 2) Turn the transceiver power ON while pressing the [PF1] key to enter the version display mode.
- 3) The Main MPU and Panel MPU versions are displayed when entering the version display mode.

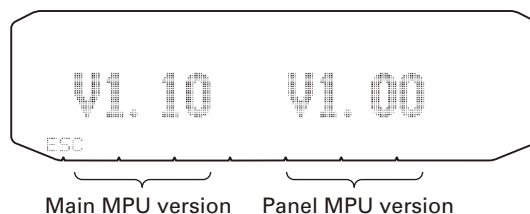

- 4) To exit the version display mode, press the [ESC] key.

■ TNC MPU version check method

After connecting the transceiver to the PC via the PG-5G (programming cable), you can confirm the TNC MPU version by accessing the personal computer communication software.

• Operation procedure

- 1) Turn the transceiver power OFF.
- 2) Connect the RS-232C serial port of the PC to the COM terminal on the rear of the operation panel via the PG-5G (Programming cable).
- 3) Turn the transceiver power ON.
- 4) Run the personal computer communication software. The method of operating personal computer communication software "HyperTerminal" attached to Windows is described here as an example.
- 5) Click the "Start" button on the PC, and then select the software as follows: "Programs" → "Accessories" → "Communications" → "HyperTerminal"

ADJUSTMENT

- 6) The HyperTerminal starts, and the "Connection Description" window is displayed.
- 7) Input the name that you want to use, in the "Name" column, then click "OK".
- 8) Change the COM Port of the "Connect using" setting if necessary. (For example, select COM1.)
- 9) After selecting "OK" on the "Connect To" window, the "COM1 Properties" window is displayed.

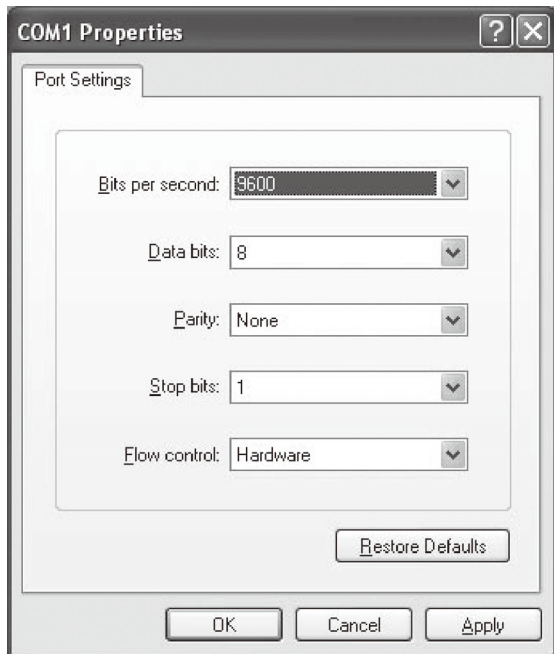

- 10) Confirm the PC terminal baud rate speed set to the transceiver by following these steps:
 - (1) Press the [F] key, then press the Tuning control.
 - (2) Select "AUX" by turning the Tuning control.
 - (3) Press the Tuning control to display the AUX menu.
 - (4) Turn the Tuning control to select menu number 519 (PC PORT BAUDRATE). The baud rate is displayed.
 - (5) Press the [ESC] key to exit menu mode.
- 11) Select the confirmed baud rate (from step 10, above) from the "Bits per second" pull-down menu on the "COM1 Properties" window.
- 12) Click "OK" on the "COM1 Properties" window. The "HyperTerminal" window is displayed.
- 13) Press the [TNC] key on the operation panel. "APRS 12 OPENING TNC" will appear on the display for approximately 1 second, followed by "APRS12". Press the [TNC] key again to enter the packet mode. The TNC MPU version is displayed on the HyperTerminal window.

```
Kenwood Radio Modem      TNC MPU version
AX.25 Level 2 Version 2.0
Release 23/Jun/07 3Chip ver 1.00
Checksum $FD16
cmd:DA 070702113600
cmd:
```
- 14) To exit the packet mode, press the [TNC] key.

Measuring Equipment for Alignment

1. Digital voltmeter (D.V.M)

Input impedance: High

2. RF valve voltmeter (RF V.M)

Input impedance: 1MΩ or more, 2pF or less

Voltage range: Full scale=10mV to 300V

Measurable frequency range: Up to 450MHz

3. Frequency counter (f.counter)

Input sensitivity: About 50mV

Measurable frequency: 450MHz or more

4. DC power supply

Voltage: Variable in the range 10 to 17V

Current: 13A or more

5. Power meter

Measurement power: 60W, 30W, 10W

Impedance: 50Ω

Measurable frequency: 450MHz

6. AF valve voltmeter (AF V.M)

Input impedance: 1MΩ or more

Voltage range: Full scale=1mV to 30V

Measurable frequency range: 50Hz to 10kHz

7. AF generator (AG)

Output frequency: 100Hz to 10kHz

Output voltage: 0.5mV to 1V

8. Linear detector

Measurable frequency: 450MHz

9. Spectrum analyzer

Measurable frequency: 450MHz

10. Directional coupler

11. Oscilloscope

High sensitivity with horizontal input terminal

12. Standard signal generator (SSG)

The standard signal generator must be able to generate the 1.3GHz band frequencies and vary the amplitude and frequency.

Output: -133dBm to greater than -13dBm

13. Dummy load (for AF)

8Ω, about 5W

14. Noise generator

The noise generator must be able to generate noise similar to ignition noise containing high-frequency components of 450MHz or more.

15. Sweep generator

The sweep generator must be able to sweep the 144 and 430MHz bands.

16. Tracking generator

ADJUSTMENT

Preparation

- To protect the signal generator, never connect the microphone to the microphone jack when the receiver section is adjusted.
- Without specification of SSG, standard modulation is applied (MOD: 1kHz, DEV: ±3kHz)

■ Operation panel (Front)

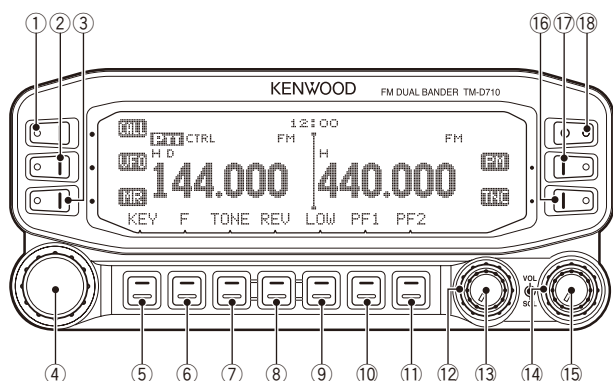

- | | |
|------------------|--------------------------|
| ① CALL | ⑩ PF1 |
| ② VFO | ⑪ PF2 |
| ③ MR | ⑫ SQL (Band A) |
| ④ Tuning control | ⑬ BAND SEL/ VOL (Band A) |
| ⑤ KEY | ⑭ SQL (Band B) |
| ⑥ F | ⑮ BAND SEL/ VOL (Band B) |
| ⑦ TONE | ⑯ TNC |
| ⑧ REV | ⑰ PM |
| ⑨ LOW | ⑱ Power switch |

■ TX/RX unit (Rear)

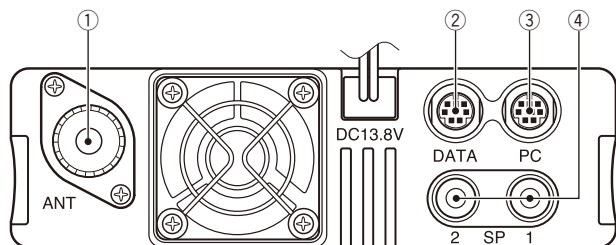

- | | |
|--------|----------------|
| ① ANT | ③ PC |
| ② DATA | ④ SP (SP1/SP2) |

■ Microphone jack (as viewed from the front of the transceiver)

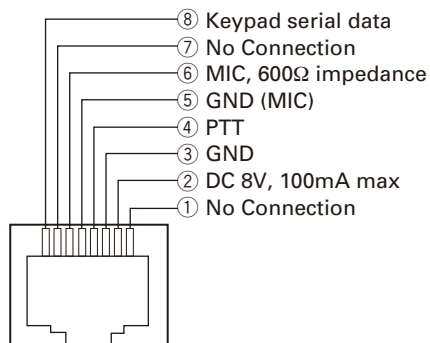

Service Jig

■ Extension flat cable (50-pin) (E37-1407-05), about 10cm

to TX-RX unit (X57-731 A/6) connector (CN677)

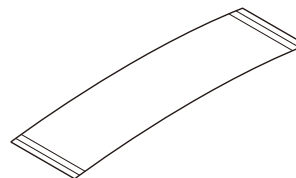

to TX-RX (control section) unit (X57-731 D/6) connector (CN960)

While servicing the unit, if you are checking the foil side of the TX-RX unit (X57-731 A/6), replace the original flat cable with extension cable (E37-1407-05).

■ Data terminal short plug (W05-0611-00)

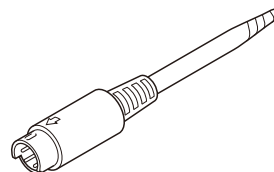

Insert the adjustment jig (W05-0611-00) into the DATA connector located on the rear panel of the transceiver.

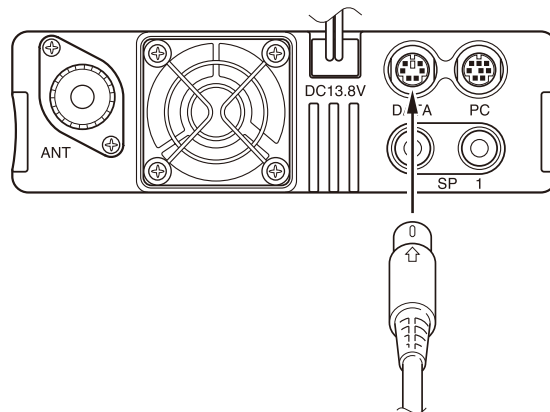

• DATA connector pin assignment

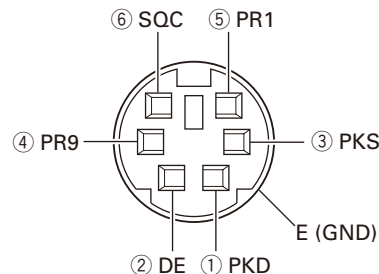

- Terminals ③ and ⑥ are short circuited.
- ③ PKS (SEND switch for DATA terminal)
Connect PTT output. If PKS is set to "GND", data are sent and the microphone will be mute.
- ⑥ SQC (Squelch control output)
This outputs squelch control output.

ADJUSTMENT

Adjustment Mode

The transceiver can be adjusted using its panel keys.

■ Adjustment Items

1. Frequency (Band A)
2. Frequency (Band B)
3. High power (144MHz band, 430MHz band)
4. Mid power (144MHz band, 430MHz band)
5. Low power (144MHz band, 430MHz band)
6. SWR protection (144MHz band, 430MHz band)
7. DCS balance (Band A) (144MHz band, 430MHz band)
8. DCS balance (Band B) (144MHz band, 430MHz band)
9. MAX deviation (Band A) (144MHz band, 430MHz band)
10. MAX deviation (Band B) (144MHz band, 430MHz band)
11. CTCSS deviation (Band A) (144MHz band, 430MHz band)
12. CTCSS deviation (Band B) (144MHz band, 430MHz band)
13. DCS deviation (Band A) (144MHz band, 430MHz band)
14. DCS deviation (Band B) (144MHz band, 430MHz band)
15. BPF RSSI (Band A) (144MHz band, 200MHz band, 430MHz band)*1
16. BPF RSSI (Band B) (144MHz band, 200MHz band, 430MHz band)*1
17. Squelch threshold (Band A) (144MHz band, 200MHz band, 300MHz band, 430MHz band)
18. Squelch threshold (Band B) (144MHz band, 200MHz band, 300MHz band, 430MHz band, 1.2GHz band)
19. Squelch tight (Band A) (144MHz band, 200MHz band, 300MHz band, 430MHz band)
20. Squelch tight (Band B) (144MHz band, 200MHz band, 300MHz band, 430MHz band, 1.2GHz band)
21. S-meter S1 (Band A) (144MHz band, 200MHz band, 300MHz band, 430MHz band)
22. S-meter S1 (Band B) (144MHz band, 200MHz band, 300MHz band, 430MHz band, 1.2GHz band)
23. S-meter full scale (Band A) (144MHz band, 200MHz band, 300MHz band, 430MHz band)
24. S-meter full scale (Band B) (144MHz band, 200MHz band, 300MHz band, 430MHz band, 1.2GHz band)

*1: Adjust 3 points (Low, Center, High) for the 144MHz band and the 200MHz band.
Adjust 5 points (Low, Low', Center, High', High) for the 430MHz band.

■ How to enter the adjustment mode

1. Turn the transceiver power OFF and insert the data terminal short plug (W05-0611-00) into the DATA terminal located on the rear panel of the transceiver.
2. Turn the transceiver power ON while pressing the [KEY] and [F] keys to enter adjustment mode.

3. The adjustment item "FRQ A" of the Band A frequency is displayed when entering the adjustment mode.



4. Remove the data terminal short plug from the DATA terminal of the transceiver.

Note:

- To exit the Adjustment Mode, turn the transceiver power OFF.
- When the adjustment mode is activated, the transceiver automatically sets the frequency as shown in "The frequency that is set to the transceiver" table, on pages 36 to 38.

■ LCD display in the adjustment mode

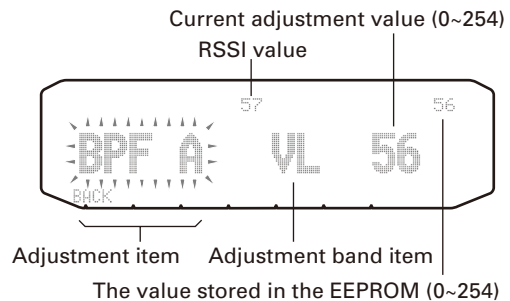

■ Panel key operation in the adjustment mode

Key name		Function
Tuning control	(Turn)	<ul style="list-style-type: none"> • Changes the adjustment item or adjustment band item. • Increase or decrease the adjustment values (0~254).
	(Press)	<ul style="list-style-type: none"> • Movement from the adjustment item display to the adjustment band item display or movement from the adjustment band item display to the adjustment value display. (Forward) • Write adjustment values.
[CALL], [BACK]		Movement from the adjustment value display to the adjustment band item display or movement from the adjustment band item display to the adjustment item display. (Back)
[VFO],[MR],[F],[TONE],[REV],[LOW],[PF1],[PF2],[TNC],[PM]		Unused
Microphone key		
[PTT]		Transmit. (Only the adjustment item of the transmitter section can be used.)

ADJUSTMENT

■ Example of the adjustment mode operation procedure

The operating procedure when the BPF RSSI of band A (430MHz band, low frequency) is adjusted is described as follows.

The adjustment item "FRQ A" of the band A frequency is displayed when entering the adjustment mode according to the operating procedure of "How to enter the adjustment mode" described on page 34.

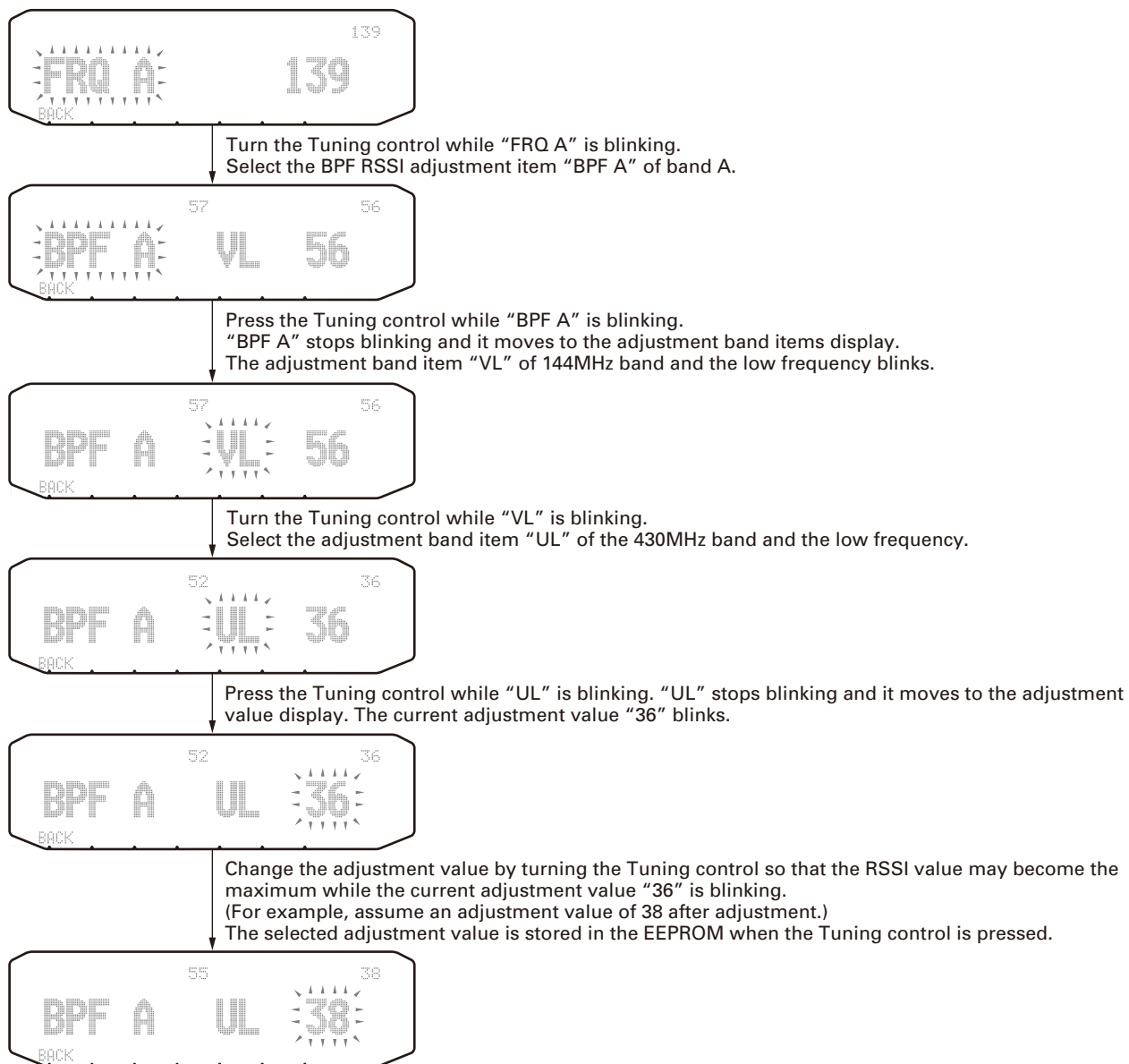

ADJUSTMENT

■ Adjustment item, adjustment band item, display and the frequency that is set to the transceiver

No.	Adjustment item	Adjustment band item	Display		The frequency that is set to the transceiver		Signaling
			Adjustment item	Adjustment band item	K type	E, M4 types	
1	Frequency (Band A)	-	FRQ A	-	444.100MHz	435.100MHz	
2	Frequency (Band B)	-	FRQ B	-	444.100MHz	435.100MHz	
3	High power	144MHz band	HPWR	V	146.100MHz	145.100MHz	
		430MHz band	HPWR	U	444.100MHz	435.100MHz	
4	Mid power	144MHz band	MPWR	V	146.100MHz	145.100MHz	
		430MHz band	MPWR	U	444.100MHz	435.100MHz	
5	Low power	144MHz band	LPWR	V	146.100MHz	145.100MHz	
		430MHz band	LPWR	U	444.100MHz	435.100MHz	
6	SWR protection	144MHz band	SWR	V	146.100MHz	145.100MHz	
		430MHz band	SWR	U	444.100MHz	435.100MHz	
7	DCS balance *1 (Band A)	144MHz band, Low frequency	BAL A	VL	136.100MHz	136.100MHz	
		144MHz band, Center frequency	BAL A	VC	146.100MHz	145.100MHz	
		144MHz band, High frequency	BAL A	VH	173.900MHz	173.900MHz	
		430MHz band, Low frequency	BAL A	UL	400.100MHz	400.100MHz	
		430MHz band, Center frequency	BAL A	UC	444.100MHz	435.100MHz	
		430MHz band, High frequency	BAL A	UH	469.900MHz	469.900MHz	
8	DCS balance *1 (Band B)	144MHz band, Low frequency	BAL B	VL	136.100MHz	136.100MHz	
		144MHz band, Center frequency	BAL B	VC	146.100MHz	145.100MHz	
		144MHz band, High frequency	BAL B	VH	173.900MHz	173.900MHz	
		430MHz band, Low frequency	BAL B	UL	400.100MHz	400.100MHz	
		430MHz band, Center frequency	BAL B	UC	444.100MHz	435.100MHz	
		430MHz band, High frequency	BAL B	UH	469.900MHz	469.900MHz	
9	MAX deviation (Band A)	144MHz band	DEV A	V	146.100MHz	145.100MHz	
		430MHz band	DEV A	U	444.100MHz	435.100MHz	
10	MAX deviation (Band B)	144MHz band	DEV B	V	146.100MHz	145.100MHz	
		430MHz band	DEV B	U	444.100MHz	435.100MHz	
11	CTCSS deviation (Band A)	144MHz band	CT A	V	146.100MHz	145.100MHz	CTCSS: 91.5Hz
		430MHz band	CT A	U	444.100MHz	435.100MHz	
12	CTCSS deviation (Band B)	144MHz band	CT B	V	146.100MHz	145.100MHz	CTCSS: 91.5Hz
		430MHz band	CT B	U	444.100MHz	435.100MHz	
13	DCS deviation (Band A)	144MHz band	DCS A	V	146.100MHz	145.100MHz	DCS: 023
		430MHz band	DCS A	U	444.100MHz	435.100MHz	
14	DCS deviation (Band B)	144MHz band	DCS B	V	146.100MHz	145.100MHz	DCS: 023
		430MHz band	DCS B	U	444.100MHz	435.100MHz	

*1: The DCS balance adjustment can adjust only the center frequency.

ADJUSTMENT

No.	Adjustment item	Adjustment band item	Display		The frequency that is set to the transceiver		Signaling
			Adjustment item	Adjustment band item	K type	E, M4 types	
15	BPF RSSI (Band A)	144MHz band, Low frequency	BPF A	VL	118.050MHz	118.050MHz	
		144MHz band, Center frequency	BPF A	VC	145.050MHz	145.050MHz	
		144MHz band, High frequency	BPF A	VH	199.950MHz	199.950MHz	
		200MHz band, Low frequency	BPF A	2L	220.050MHz	220.050MHz	
		200MHz band, Center frequency	BPF A	2C	250.050MHz	250.050MHz	
		200MHz band, High frequency	BPF A	2H	279.950MHz	279.950MHz	
		430MHz band, Low frequency	BPF A	UL	300.050MHz	300.050MHz	
		430MHz band, Low' frequency	BPF A	ULD	350.050MHz	350.050MHz	
		430MHz band, Center frequency	BPF A	UC	400.050MHz	400.050MHz	
		430MHz band, High' frequency	BPF A	UHD	440.050MHz	440.050MHz	
		430MHz band, High frequency	BPF A	UH	500.050MHz	500.050MHz	
16	BPF RSSI (Band B)	144MHz band, Low frequency	BPF B	VL	118.050MHz	118.050MHz	
		144MHz band, Center frequency	BPF B	VC	145.050MHz	145.050MHz	
		144MHz band, High frequency	BPF B	VH	199.950MHz	199.950MHz	
		200MHz band, Low frequency	BPF B	2L	220.050MHz	220.050MHz	
		200MHz band, Center frequency	BPF B	2C	250.050MHz	250.050MHz	
		200MHz band, High frequency	BPF B	2H	279.950MHz	279.950MHz	
		430MHz band, Low frequency	BPF B	UL	300.050MHz	300.050MHz	
		430MHz band, Low' frequency	BPF B	ULD	350.050MHz	350.050MHz	
		430MHz band, Center frequency	BPF B	UC	400.050MHz	400.050MHz	
		430MHz band, High' frequency	BPF B	UHD	440.050MHz	440.050MHz	
		430MHz band, High frequency	BPF B	UH	500.050MHz	500.050MHz	
17	Squelch threshold (Band A)	144MHz band	SQ1 A	V	145.050MHz	145.050MHz	
		200MHz band	SQ1 A	2	220.050MHz	220.050MHz	
		300MHz band	SQ1 A	3	350.050MHz	350.050MHz	
		430MHz band	SQ1 A	U	440.050MHz	440.050MHz	
18	Squelch threshold (Band B)	144MHz band	SQ1 B	V	145.050MHz	145.050MHz	
		200MHz band	SQ1 B	2	220.050MHz	220.050MHz	
		300MHz band	SQ1 B	3	350.050MHz	350.050MHz	
		430MHz band	SQ1 B	U	440.050MHz	440.050MHz	
		1.2GHz band	SQ1 B	8	1270.050MHz	1270.050MHz	
19	Squelch tight (Band A)	144MHz band	SQT A	V	145.050MHz	145.050MHz	
		200MHz band	SQT A	2	220.050MHz	220.050MHz	
		300MHz band	SQT A	3	350.050MHz	350.050MHz	
		430MHz band	SQT A	U	440.050MHz	440.050MHz	

ADJUSTMENT

No.	Adjustment item	Adjustment band item	Display		The frequency that is set to the transceiver		Signaling
			Adjustment item	Adjustment band item	K type	E, M4 types	
20	Squelch tight (Band B)	144MHz band	SQT B	V	145.050MHz	145.050MHz	
		200MHz band	SQT B	2	220.050MHz	220.050MHz	
		300MHz band	SQT B	3	350.050MHz	350.050MHz	
		430MHz band	SQT B	U	440.050MHz	440.050MHz	
		1.2GHz band	SQT B	8	1270.050MHz	1270.050MHz	
21	S-meter S1 (Band A)	144MHz band	SM1 A	V	145.050MHz	145.050MHz	
		200MHz band	SM1 A	2	220.050MHz	220.050MHz	
		300MHz band	SM1 A	3	350.050MHz	350.050MHz	
		430MHz band	SM1 A	U	440.050MHz	440.050MHz	
22	S-meter S1 (Band B)	144MHz band	SM1 B	V	145.050MHz	145.050MHz	
		200MHz band	SM1 B	2	220.050MHz	220.050MHz	
		300MHz band	SM1 B	3	350.050MHz	350.050MHz	
		430MHz band	SM1 B	U	440.050MHz	440.050MHz	
		1.2GHz band	SM1 B	8	1270.050MHz	1270.050MHz	
23	S-meter full scale (Band A)	144MHz band	SM7 A	V	145.050MHz	145.050MHz	
		200MHz band	SM7 A	2	220.050MHz	220.050MHz	
		300MHz band	SM7 A	3	350.050MHz	350.050MHz	
		430MHz band	SM7 A	U	440.050MHz	440.050MHz	
24	S-meter full scale (Band B)	144MHz band	SM7 B	V	145.050MHz	145.050MHz	
		200MHz band	SM7 B	2	220.050MHz	220.050MHz	
		300MHz band	SM7 B	3	350.050MHz	350.050MHz	
		430MHz band	SM7 B	U	440.050MHz	440.050MHz	
		1.2GHz band	SM7 B	8	1270.050MHz	1270.050MHz	

ADJUSTMENT

Common Section

Item	Condition	Measurement			Adjustment			Specifications / Remarks
		Test-equipment	Unit	Terminal	Unit	Parts	Method	
1. Setting	1) Power supply voltage DC power supply terminal : 13.8V							
2. Full reset	1) Full reset Turn the transceiver power ON by pressing the power switch while [F] key is pressed. Release the [F] key. Select reset type "FULL RESET" by tuning the Tuning control when the reset confirmation message appears. Press the Tuning control to set the reset type. Press the Tuning control again to perform the full reset. * This adjustment mode has an adjustment item to be used as is in the user mode setting contents (AIP, menu mode, etc). Therefore, if you do not perform the full reset, it may be adjusted unintentionally.							
<div style="border: 1px solid black; padding: 5px;"> <p>Note: When you do not want to remove data such as memory channel data, save the data using the MCP-2A (Memory control program) before performing the full reset, then write the data to the transceiver after performing the adjustment.</p> </div>								

Transmitter Section: Adjustment Mode Setting Items

(Refer to the table on pages 36 to 38 for the frequencies which will apply in the adjustment mode.)

Item	Condition	Measurement			Adjustment			Specifications / Remarks
		Test-equipment	Unit	Terminal	Unit	Parts	Method	
1. Frequency (Band A) Adjust	1) Adj item: [FRQ A] Adjust: [***] 2) PTT: ON	f. counter	TX/RX unit (Rear)	ANT	Operation panel (Front)	Tuning control	Write	435.100MHz±100Hz E,M4 444.100MHz±100Hz K
2. Frequency (Band B) Adjust	1) Adj item: [FRQ B] Adjust: [***] 2) PTT: ON							
3. High power Adjust • 144MHz band	1) Adj item: [HPWR V] Adjust: [***] 2) PTT: ON	Power meter					Write	50W±1W
• 430MHz band	3) Adj item: [HPWR U] Adjust: [***] 4) PTT: ON							48W±1W
4. Mid power Adjust • 144MHz band	1) Adj item: [MPWR V] Adjust: [***] 2) PTT: ON						Write	12W±1W K,E 22.5W±1W M4
• 430MHz band	3) Adj item: [MPWR U] Adjust: [***] 4) PTT: ON							
5. Low power Adjust • 144MHz band	1) Adj item: [LPWR V] Adjust: [***] 2) PTT: ON						Write	5W±1W
• 430MHz band	3) Adj item: [LPWR U] Adjust: [***] 4) PTT: ON							

ADJUSTMENT

Item	Condition	Measurement			Adjustment			Specifications / Remarks
		Test-equipment	Unit	Terminal	Unit	Parts	Method	
6. SWR protection Adjust • 144MHz band	1) Adj item: [SWR V] Adjust: [***] 2) PTT: ON	Power meter	TX/RX unit (Rear)	ANT	Operation panel (Front)	Tuning control	Set the following adjustment values to the transceiver by turning the Tuning control. * When the transceiver is shipped, the SWR adjustment value is different from that which is stated in this manual, as SWR protection adjustment is performed at production. Although there is a difference in the numerical value, this does not pose a problem, as the adjustment value provided in this manual is the mean value. Adjustment value: 66	
• 430MHz band	3) Adj item: [SWR U] Adjust: [***] 4) PTT: ON						Adjustment value: 120	
7. DCS balance (Band A) Adjust • 144MHz band	1) Adj item: [BAL A VC] Adjust: [***] Detector: +P HOLD LPF: 3kHz HPF: OFF De-emphasis: OFF 2) PTT: ON	Linear detector Oscilloscope					By turning the Tuning control, adjust the modulation wave until it becomes the square wave.	
• 430MHz band	3) Adj item: [BAL A UC] Adjust: [***] 4) PTT: ON							
8. DCS balance (Band B) Adjust • 144MHz band	1) Adj item: [BAL B VC] Adjust: [***] Detector: +P HOLD LPF: 3kHz HPF: OFF De-emphasis: OFF 2) PTT: ON							
• 430MHz band	3) Adj item: [BAL B UC] Adjust: [***] 4) PTT: ON							
9. MAX deviation (Band A) Adjust • 144MHz band	1) Adj item: [DEV A V] Adjust: [***] AG: 1kHz/50mV K,M4 AG: 1kHz/20mV E Detector: +P, -P LPF: 15kHz HPF: OFF De-emphasis: OFF 2) PTT: ON	Linear detector Oscilloscope AG AF V.M		ANT MIC			Write	4.2kHz±0.1kHz (According to the larger +P, -P)
• 430MHz band	3) Adj item: [DEV A U] Adjust: [***] 4) PTT: ON							
10. MAX deviation (Band B) Adjust • 144MHz band	1) Adj item: [DEV B V] Adjust: [***] AG: 1kHz/50mV K,M4 AG: 1kHz/20mV E Detector: +P, -P LPF: 15kHz HPF: OFF De-emphasis: OFF 2) PTT: ON							
• 430MHz band	3) Adj item: [DEV B U] Adjust: [***] 4) PTT: ON							

ADJUSTMENT

Item	Condition	Measurement			Adjustment			Specifications / Remarks
		Test-equipment	Unit	Terminal	Unit	Parts	Method	
11. CTCSS deviation (Band A) Adjust • 144MHz band	1) Adj item: [CT A V] Adjust: [***] Detector: P-P/2 LPF: 3kHz HPF: OFF De-emphasis: OFF PTT:ON	Linear detector Oscilloscope	TX/RX unit (Rear)	ANT	Operation panel (Front)	Tuning control	Write	0.75kHz±0.05kHz
	• 430MHz band							
12. CTCSS deviation (Band B) Adjust • 144MHz band	1) Adj item: [CT B V] Adjust: [***] Detector: P-P/2 LPF: 3kHz HPF: OFF De-emphasis: OFF PTT: ON							
	• 430MHz band						2) Adj item: [CT B U] Adjust: [***] PTT: ON	
13. DCS deviation (Band A) Adjust • 144MHz band	1) Adj item: [DCS A V] Adjust: [***] Detector: +P HOLD LPF: 3kHz HPF: OFF De-emphasis: OFF PTT: ON						Write	0.75kHz±0.05kHz
	• 430MHz band							
14. DCS deviation (Band B) Adjust • 144MHz band	1) Adj item: [DCS B V] Adjust: [***] Detector: +P HOLD LPF: 3kHz HPF: OFF De-emphasis: OFF PTT: ON							
	• 430MHz band						2) Adj item: [DCS B U] Adjust: [***] PTT: ON	

Transmitter Section: User Mode Confirmation Items

(Do not insert the data terminal short plug to the DATA terminal of the transceiver when entering user mode.)

Item	Condition	Measurement			Adjustment			Specifications / Remarks
		Test-equipment	Unit	Terminal	Unit	Parts	Method	
1. High power Check • Band A	1) Frequency: 144.000MHz 2) Frequency: 145.990MHz E Frequency: 147.990MHz K 3) PTT: ON	Power meter Ammeter	TX/RX unit (Rear)	ANT			Check	47~53W 12A or less
	4) Frequency: 430.000MHz E Frequency: 438.000MHz K 5) Frequency: 435.000MHz E Frequency: 444.000MHz K 6) Frequency: 439.990MHz E Frequency: 449.990MHz K 7) PTT: ON							45~51W 12A or less

ADJUSTMENT

Item	Condition	Measurement			Adjustment			Specifications / Remarks
		Test-equipment	Unit	Terminal	Unit	Parts	Method	
• Band B	8) Frequency: 144.000MHz 9) Frequency: 145.000MHz E Frequency: 146.000MHz K 10) Frequency: 145.990MHz E Frequency: 147.990MHz K 11) PTT: ON	Power meter Ammeter	TX/RX unit (Rear)	ANT			Check	47~53W 12A or less
	12) Frequency: 430.000MHz E Frequency: 438.000MHz K 13) Frequency: 439.990MHz E Frequency: 449.990MHz K 14) PTT: ON							45~51W 12A or less
2. Mid power Check • Band A	1) Frequency: 144.000MHz 2) Frequency: 145.990MHz E,M4 Frequency: 147.990MHz K 3) PTT: ON						Check	K,E: 11~13W, 5A or less M4: 20.5~24.5W, 8A or less
	4) Frequency: 430.000MHz E,M4 Frequency: 438.000MHz K 5) Frequency: 435.000MHz E,M4 Frequency: 444.000MHz K 6) Frequency: 439.990MHz E,M4 Frequency: 449.990MHz K 7) PTT: ON							K,E: 11~13W, 6A or less M4: 20.5~24.5W, 8A or less
• Band B	8) Frequency: 144.000MHz 9) Frequency: 145.000MHz E,M4 Frequency: 146.000MHz K 10) Frequency: 145.990MHz E,M4 Frequency: 147.990MHz K 11) PTT: ON						Check	K,E: 11~13W, 5A or less M4: 20.5~24.5W, 8A or less
	12) Frequency: 430.000MHz E,M4 Frequency: 438.000MHz K 13) Frequency: 439.990MHz E,M4 Frequency: 449.990MHz K 14) PTT: ON							K,E: 11~13W, 6A or less M4: 20.5~24.5W, 8A or less
3. Low power Check • Band A	1) Frequency: 144.000MHz 2) Frequency: 145.990MHz E,M4 Frequency: 147.990MHz K 3) PTT: ON						Check	4~6W 3.5A or less
	4) Frequency: 430.000MHz E,M4 Frequency: 438.000MHz K 5) Frequency: 435.000MHz E,M4 Frequency: 444.000MHz K 6) Frequency: 439.990MHz E,M4 Frequency: 449.990MHz K 7) PTT: ON							4~6W 4.5A or less
• Band B	8) Frequency: 144.000MHz 9) Frequency: 145.000MHz E,M4 Frequency: 146.000MHz K 10) Frequency: 145.990MHz E,M4 Frequency: 147.990MHz K 11) PTT: ON						Check	4~6W 3.5A or less
	12) Frequency: 430.000MHz E,M4 Frequency: 438.000MHz K 13) Frequency: 439.990MHz E,M4 Frequency: 449.990MHz K 14) PTT: ON							4~6W 4.5A or less

ADJUSTMENT

Item	Condition	Measurement			Adjustment			Specifications / Remarks
		Test-equipment	Unit	Terminal	Unit	Parts	Method	
4. MIC sensitivity Check • Band A	1) Frequency: 145.000MHz E,M4 Frequency: 146.000MHz K AG: 1kHz/5mV K,M4 AG: 1kHz/2mV E Detector: P-P/2 LPF: 15kHz HPF: OFF De-emphasis: OFF 2) PTT: ON	Linear detector Oscilloscope AG AF V.M	TX/RX unit (Rear)	ANT MIC			Check	±2.34~4.17kHz K,M4 ±2.38~4.05kHz E
	3) Frequency: 435.000MHz E,M4 Frequency: 444.000MHz K 4) PTT: ON							
	• Band B							
	5) Frequency: 145.000MHz E,M4 Frequency: 146.000MHz K AG: 1kHz/5mV K,M4 AG: 1kHz/2mV E Detector: P-P/2 LPF: 15kHz HPF: OFF De-emphasis: OFF 6) PTT: ON							
	7) Frequency: 435.000MHz E,M4 Frequency: 444.000MHz K 8) PTT: ON					Check	±2.34~4.17kHz K,M4 ±2.38~4.05kHz E	
5. CTCSS deviation Check • Band A	1) Frequency: 145.000MHz E,M4 Frequency: 146.000MHz K Detector: P-P/2 LPF: 3kHz HPF: OFF De-emphasis: OFF 2) PTT: ON	Linear detector Oscilloscope		ANT			Check	0.65~0.85kHz
	3) Frequency: 435.000MHz E,M4 Frequency: 444.000MHz K 4) PTT: ON							
	• Band B							
	5) Frequency: 145.000MHz E,M4 Frequency: 146.000MHz K Detector: P-P/2 LPF: 3kHz HPF: OFF De-emphasis: OFF 6) PTT: ON							
	7) Frequency: 435.000MHz E,M4 Frequency: 444.000MHz K 8) PTT: ON							
6. DCS deviation Check • Band A	1) Frequency: 145.000MHz E,M4 Frequency: 146.000MHz K Detector: +P HOLD LPF: 3kHz HPF: OFF De-emphasis: OFF 2) PTT: ON						Check	0.65~0.85kHz
	3) Frequency: 435.000MHz E,M4 Frequency: 444.000MHz K 4) PTT: ON							

ADJUSTMENT

Item	Condition	Measurement			Adjustment			Specifications / Remarks
		Test-equipment	Unit	Terminal	Unit	Parts	Method	
• Band B	5) Frequency: 145.000MHz E,M4 Frequency: 146.000MHz K Detector: +P HOLD LPF: 3kHz HPF: OFF De-emphasis: OFF 6) PTT: ON	Linear detector Oscilloscope	TX/RX unit (Rear)	ANT			Check	0.65~0.85kHz
	7) Frequency: 435.000MHz E,M4 Frequency: 444.000MHz K 8) PTT: ON							
7 .Protection Check • Band A	TX Power: High K,E Mid M4 ANT: Short circuit and Open 1) Frequency: 145.000MHz E,M4 Frequency: 146.000MHz K 2) PTT: ON	Ammeter					Check	12A or less
• Band B	3) Frequency: 435.000MHz E,M4 Frequency: 444.000MHz K 4) PTT: ON							

Receiver Section: Adjustment Mode Setting Items

(Refer to the table on pages 36 to 38 for the frequencies which will apply in the adjustment mode.)

Item	Condition	Measurement			Adjustment			Specifications / Remarks																
		Test-equipment	Unit	Terminal	Unit	Parts	Method																	
1. BPF RSSI (Band A) Adjust • 144MHz band	1) Adj item: [BPF A VL] → [BPF A VH] Adjust: [***] SSG output: -100dBm (2.24μV) SSG MOD: 1kHz SSG DEV: 3kHz	SSG Oscilloscope Distortion meter AF V.M Dummy load	TX/RX unit (Rear)	ANT EXT.SP	Operation panel (Front)	Tuning control	Turn the Tuning control until the maximum RSSI value will appear on the LCD. When the same RSSI value remains while it is being adjusted, set the adjustment value to the center value. For example, set the adjustment value to 38 for the values listed below.																	
	• 200MHz band								2) Adj item: [BPF A 2L] Adjust: [***] SSG output: -100dBm (2.24μV) 3) Adj item: [BPF A 2C] Adjust: [***] SSG output: -90dBm (7.08μV) 4) Adj item: [BPF A 2H] Adjust: [***] SSG output: -80dBm (22.4μV)															
	• 430MHz band								5) Adj item: [BPF A UL] Adjust: [***] SSG output: -90dBm (7.08μV) 6) Adj item: [BPF A ULD] → [BPF A UC] → [BPF A UHD] → [BPF A UH] Adjust: [***] SSG output: -100dBm (2.24μV)															
							<table border="1"> <thead> <tr> <th>RSSI value</th> <th>Adjustment value</th> </tr> </thead> <tbody> <tr><td>54</td><td>35</td></tr> <tr><td>55</td><td>36</td></tr> <tr><td>55</td><td>37</td></tr> <tr><td>55</td><td>38</td></tr> <tr><td>55</td><td>39</td></tr> <tr><td>55</td><td>40</td></tr> <tr><td>54</td><td>41</td></tr> </tbody> </table>	RSSI value	Adjustment value	54	35	55	36	55	37	55	38	55	39	55	40	54	41	
RSSI value	Adjustment value																							
54	35																							
55	36																							
55	37																							
55	38																							
55	39																							
55	40																							
54	41																							

ADJUSTMENT

Item	Condition	Measurement			Adjustment			Specifications / Remarks	
		Test-equipment	Unit	Terminal	Unit	Parts	Method		
2. BPF RSSI (Band B) Adjust • 144MHz band	1) Adj item: [BPF B VL] → [BPF B VC] → [BPF B VH] Adjust: [***] SSG output: -100dBm (2.24μV) SSG MOD: 1kHz SSG DEV: 3kHz	SSG Oscilloscope Distortion meter AF V.M Dummy load	TX/RX unit (Rear)	ANT EXT.SP	Operation panel (Front)	Tuning control	Turn the Tuning control until the maximum RSSI value will appear on the LCD. When the same RSSI value remains while it is being adjusted, set the adjustment value to the center value. For example, set the adjustment value to 38 for the values listed below.		
	• 200MHz band								2) Adj item: [BPF B 2L] Adjust: [***] SSG output: -100dBm (2.24μV) 3) Adj item: [BPF B 2C] Adjust: [***] SSG output: -90dBm (7.08μV) 4) Adj item: [BPF B 2H] Adjust: [***] SSG output: -80dBm (22.4μV)
	• 430MHz band								5) Adj item: [BPF B UL] Adjust: [***] SSG output: -90dBm (7.08μV) 6) Adj item: [BPF B ULD] → [BPF A UC] → [BPF A UHD] → [BPF A UH] Adjust: [***] SSG output: -100dBm (2.24μV)
3. Squelch threshold (Band A) Writing • 144MHz band	1) Adj item: [SQ1 A V] Adjust: [***] SSG output: -128dBm (0.089μV) SSG MOD: 1kHz SSG DEV: 3kHz	SSG		ANT			Write		
	• 200MHz band								2) Adj item: [SQ1 A 2] Adjust: [***] SSG output: -117dBm (0.32μV)
	• 300MHz band								3) Adj item: [SQ1 A 3] Adjust: [***] SSG output: -117dBm (0.32μV)
	• 430MHz band								4) Adj item: [SQ1 A U] Adjust: [***] SSG output: -128dBm (0.089μV)
4. Squelch threshold (Band B) Writing • 144MHz band	1) Adj item: [SQ1 B V] Adjust: [***] SSG output: -128dBm (0.089μV) SSG MOD: 1kHz SSG DEV: 3kHz								
	• 200MHz band								2) Adj item: [SQ1 B 2] Adjust: [***] SSG output: -117dBm (0.32μV)
	• 300MHz band								3) Adj item: [SQ1 B 3] Adjust: [***] SSG output: -117dBm (0.32μV)
	• 430MHz band								4) Adj item: [SQ1 B U] Adjust: [***] SSG output: -128dBm (0.089μV)
	• 1.2GHz band								5) Adj item: [SQ1 B 8] Adjust: [***] SSG output: -108dBm (0.89μV)

RSSI value	Adjustment value
54	35
55	36
55	37
55	38
55	39
55	40
54	41

ADJUSTMENT

Item	Condition	Measurement			Adjustment			Specifications / Remarks	
		Test-equipment	Unit	Terminal	Unit	Parts	Method		
5. Squelch tight (Band A) Writing • 144MHz band	1) Adj item: [SQT A V] Adjust: [***] SSG output: -119dBm (0.25µV) SSG MOD: 1kHz SSG DEV: 3kHz	SSG	TX/RX unit (Rear)	ANT	Operation panel (Front)	Tuning control	Write		
	• 200MHz band								2) Adj item: [SQT A 2] Adjust: [***] SSG output: -108dBm (0.89µV)
	• 300MHz band								3) Adj item: [SQT A 3] Adjust: [***] SSG output: -108dBm (0.89µV)
	• 430MHz band								4) Adj item: [SQT A U] Adjust: [***] SSG output: -119dBm (0.25µV)
6. Squelch tight (Band B) Writing • 144MHz band	1) Adj item: [SQT B V] Adjust: [***] SSG output: -119dBm (0.25µV) SSG MOD: 1kHz SSG DEV: 3kHz								
	• 200MHz band								2) Adj item: [SQT B 2] Adjust: [***] SSG output: -108dBm (0.89µV)
	• 300MHz band								3) Adj item: [SQT B 3] Adjust: [***] SSG output: -108dBm (0.89µV)
	• 430MHz band								4) Adj item: [SQT B U] Adjust: [***] SSG output: -119dBm (0.25µV)
	• 1.2GHz band								5) Adj item: [SQT B 8] Adjust: [***] SSG output: -98dBm (2.82µV)
7. S-meter S1 (Band A) Writing • 144MHz band	1) Adj item: [SM1 A V] Adjust: [***] SSG output: -118dBm (0.28µV) SSG MOD: 1kHz SSG DEV: 3kHz								
	• 200MHz band								2) Adj item: [SM1 A 2] Adjust: [***] SSG output: -108dBm (0.89µV)
	• 300MHz band								3) Adj item: [SM1 A 3] Adjust: [***] SSG output: -108dBm (0.89µV)
	• 430MHz band								4) Adj item: [SM1 A U] Adjust: [***] SSG output: -118dBm (0.28µV)

ADJUSTMENT

Item	Condition	Measurement			Adjustment			Specifications / Remarks	
		Test-equipment	Unit	Terminal	Unit	Parts	Method		
8 .S-meter S1 (Band B) Writing • 144MHz band	1) Adj item: [SM1 B V] Adjust: [***] SSG output: -118dBm (0.28μV) SSG MOD: 1kHz SSG DEV: 3kHz	SSG	TX/RX unit (Rear)	ANT	Operation panel (Front)	Tuning control	Write		
	• 200MHz band								2) Adj item: [SM1 B 2] Adjust: [***] SSG output: -108dBm (0.89μV)
	• 300MHz band								3) Adj item: [SM1 B 3] Adjust: [***] SSG output: -108dBm (0.89μV)
	• 430MHz band								4) Adj item: [SM1 B U] Adjust: [***] SSG output: -118dBm (0.28μV)
	• 1.2GHz band								5) Adj item: [SM1 B 8] Adjust: [***] SSG output: -98dBm (2.82μV)
9. S-meter full scale (Band A) Writing • 144MHz band	1) Adj item: [SM7 A V] Adjust: [***] SSG output: -96dBm (3.54μV) SSG MOD: 1kHz SSG DEV: 3kHz								
	• 200MHz band								2) Adj item: [SM7 A 2] Adjust: [***] SSG output: -86dBm (11μV)
	• 300MHz band								3) Adj item: [SM7 A 3] Adjust: [***] SSG output: -86dBm (11μV)
	• 430MHz band								4) Adj item: [SM7 A U] Adjust: [***] SSG output: -96dBm (3.54μV)
10. S-meter full scale (Band B) Writing • 144MHz band	1) Adj item: [SM7 B V] Adjust: [***] SSG output: -96dBm (3.54μV) SSG MOD: 1kHz SSG DEV: 3kHz								
	• 200MHz band								2) Adj item: [SM7 B 2] Adjust: [***] SSG output: -86dBm (11μV)
	• 300MHz band								3) Adj item: [SM7 B 3] Adjust: [***] SSG output: -86dBm (11μV)
	• 430MHz band								4) Adj item: [SM7 B U] Adjust: [***] SSG output: -96dBm (3.54μV)
	• 1.2GHz band								5) Adj item: [SM7 B 8] Adjust: [***] SSG output: -76dBm (35.4μV)

ADJUSTMENT

Receiver Section: User Mode Confirmation Items

(Check the signal band. Also, do not insert the data terminal short plug to the DATA terminal of the transceiver when entering user mode.)

Item	Condition	Measurement			Adjustment			Specifications / Remarks
		Test-equipment	Unit	Terminal	Unit	Parts	Method	
1. AF distortion Check • Band A	1) Frequency: 145.250MHz E,M4 Frequency: 146.250MHz K SSG output: -53dBm (501μV) SSG MOD: 1kHz SSG DEV: 3kHz AF output: 1V/8Ω	SSG Oscilloscope Distortion meter AF V.M Dummy load	TX/RX unit (Rear)	ANT EXT.SP			Check	4% or less
	• Band B							
2. Sensitivity Check • Band A (Wide)	1) Frequency: 145.250MHz E,M4 Frequency: 146.250MHz K SSG output: -122dBm (0.178μV) SSG MOD: 1kHz SSG DEV: 3kHz AF output: 0.63V/8Ω						Check	12dB SINAD or more
	2) Frequency: 144.250MHz SSG output: -122dBm (0.178μV)							
	3) Frequency: 145.750MHz E,M4 Frequency: 147.750MHz K SSG output: -122dBm (0.178μV)							
	4) Frequency: 430.250MHz E,M4 Frequency: 438.250MHz K SSG output: -122dBm (0.178μV)							
	5) Frequency: 435.250MHz E,M4 Frequency: 444.250MHz K SSG output: -122dBm (0.178μV)							
	6) Frequency: 439.750MHz E,M4 Frequency: 449.750MHz K SSG output: -122dBm (0.178μV)							
	7) Frequency: 136.050MHz K,E SSG output: -115dBm (0.4μV)							
	8) Frequency: 160.050MHz K,E SSG output: -115dBm (0.4μV)							
	9) Frequency: 225.050MHz K,E SSG output: -110dBm (0.707μV)							
	10) Frequency: 382.050MHz K,E SSG output: -110dBm (0.707μV)							
	11) Frequency: 400.050MHz K,E SSG output: -118dBm (0.28μV)							
	12) Frequency: 460.050MHz K,E SSG output: -100dBm (2.24μV)							
	13) Frequency: 520.050MHz K,E SSG output: -100dBm (2.24μV)							
	• Band A (Narrow)							



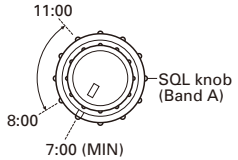
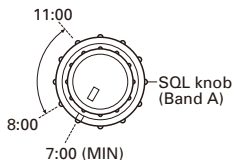
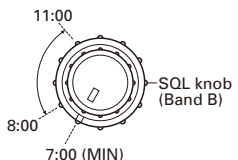

ADJUSTMENT

Item	Condition	Measurement			Adjustment			Specifications / Remarks								
		Test-equipment	Unit	Terminal	Unit	Parts	Method									
<ul style="list-style-type: none"> • Band B (Wide) 	16) Frequency: 145.250MHz E,M4 Frequency: 146.250MHz K SSG output: -122dBm (0.178μV) SSG MOD: 1kHz SSG DEV: 3kHz AF output: 0.63V/8Ω	SSG DVM Oscilloscope AF V.M	TX/RX unit (Rear)	ANT EXT.SP			Check	12dB SINAD or more								
	17) Frequency: 144.250MHz SSG output: -122dBm (0.178μV)															
	18) Frequency: 145.750MHz E,M4 Frequency: 147.750MHz K SSG output: -122dBm (0.178μV)															
	19) Frequency: 430.250MHz E,M4 Frequency: 438.250MHz K SSG output: -122dBm (0.178μV)															
	20) Frequency: 435.250MHz E,M4 Frequency: 444.250MHz K SSG output: -122dBm (0.178μV)															
	21) Frequency: 439.750MHz E,M4 Frequency: 449.750MHz K SSG output: -122dBm (0.178μV)															
	22) Frequency: 136.050MHz K,E SSG output: -115dBm (0.4μV)															
	23) Frequency: 160.050MHz K,E SSG output: -115dBm (0.4μV)															
	24) Frequency: 225.050MHz K,E SSG output: -110dBm (0.707μV)															
	25) Frequency: 382.050MHz K,E SSG output: -110dBm (0.707μV)															
	26) Frequency: 400.050MHz K,E SSG output: -118dBm (0.28μV)															
	27) Frequency: 460.050MHz K,E SSG output: -100dBm (2.24μV)															
	28) Frequency: 520.050MHz K,E SSG output: -100dBm (2.24μV)															
	29) Frequency: 859.900MHz K,E SSG output: -90dBm (7.08μV)															
	30) Frequency: 1270.050MHz K,E SSG output: -100dBm (2.24μV)															
	<ul style="list-style-type: none"> • Band B (Narrow) 								31) Frequency: 145.250MHz E,M4 Frequency: 146.250MHz K SSG output: -120dBm (0.22μV) SSG MOD: 1kHz SSG DEV: 1.5kHz AF output: 0.63V/8Ω							
									32) Frequency: 435.250MHz E,M4 Frequency: 444.250MHz K SSG output: -120dBm (0.22μV)							
	3. Hum and Noise Check <ul style="list-style-type: none"> • Band A 								1) Frequency: 145.250MHz E,M4 Frequency: 146.250MHz K SSG output: -53dBm (501μV) SSG MOD: 1kHz SSG DEV: 3kHz AF output: 1V/8Ω AF V.M: 0dB	SSG Oscilloscope Distortion meter AF V.M Dummy load						
									2) SSG DEV: OFF							
									3) Frequency: 435.000MHz E,M4 Frequency: 444.000MHz K SSG output: -53dBm (501μV) AF V.M: 0dB							
									4) SSG DEV: OFF							
														Check	-43dB or less	
														Check	-43dB or less	

ADJUSTMENT

Item	Condition	Measurement			Adjustment			Specifications / Remarks
		Test-equipment	Unit	Terminal	Unit	Parts	Method	
• Band B	5) Frequency: 145.250MHz E,M4 Frequency: 146.250MHz K SSG output: -53dBm (501μV) AF V.M: 0dB	SSG Oscilloscope Distortion meter AF V.M Dummy load	TX/RX unit (Rear)	ANT EXT.SP				
	6) SSG DEV: OFF						Check	-43dB or less
	7) Frequency: 435.000MHz E,M4 Frequency: 444.000MHz K SSG output: -53dBm (501μV) AF V.M: 0dB							
	8) SSG DEV: OFF						Check	-43dB or less
4. Squelch Check Band A • 144MHz band	1) Frequency: 145.250MHz E,M4 Frequency: 146.250MHz K SSG output: OFF Set to the point where noise will be muted by turning the SQL knob (Band A).	SSG Oscilloscope					Check	SQL knob (Band A) position: 8:00~11:00 BUSY icon disappear. 
	2) SSG output: -126dBm (0.11μV) SSG MOD: 1kHz SSG DEV: 3kHz AF output: 0.63V/8Ω							Check
• 430MHz band	3) Frequency: 435.250MHz E,M4 Frequency: 444.250MHz K SSG output: OFF Set to the point where noise will be muted by turning the SQL knob (Band A).							SQL knob (Band A) position: 8:00~11:00 BUSY icon disappear. 
	4) SSG output: -126dBm (0.11μV) SSG MOD: 1kHz SSG DEV: 3kHz AF output: 0.63V/8Ω							Check
Band B • 144MHz band	5) Frequency: 145.250MHz E,M4 Frequency: 146.250MHz K SSG output: OFF Set to the point where noise will be muted by turning the SQL knob (Band B).							SQL knob (Band B) position: 8:00~11:00 BUSY icon disappear. 
	6) SSG output: -126dBm (0.11μV) SSG MOD: 1kHz SSG DEV: 3kHz AF output: 0.63V/8Ω							Check

ADJUSTMENT

Item	Condition	Measurement			Adjustment			Specifications / Remarks
		Test-equipment	Unit	Terminal	Unit	Parts	Method	
<ul style="list-style-type: none"> • 430MHz band 	7) Frequency: 435.250MHz E,M4 Frequency: 444.250MHz K SSG output: OFF Set to the point where noise will be muted by turning the SQL knob (Band B).	SSG Oscilloscope	TX/RX unit (Rear)	ANT EXT.SP			Check	SQL knob (Band B) position: 8:00~11:00 BUSY icon disappear.
	8) SSG output: -126dBm (0.11μV) SSG MOD: 1kHz SSG DEV: 3kHz AF output: 0.63V/8Ω							Squelch open. BUSY icon appears and S-meter display does not appear.
5. S-meter Check Band A <ul style="list-style-type: none"> • 144MHz band S1 	1) Frequency: 145.250MHz E,M4 Frequency: 146.250MHz K SSG MOD: 1kHz SSG DEV: 3kHz SSG output : -118dBm (0.28μV)±3dB	SSG		ANT			Check	One segment in S-meter lights. 
	<ul style="list-style-type: none"> • 144MHz band Full scale 							SSG output : -96dBm (3.54μV)±3dB
<ul style="list-style-type: none"> • 430MHz band S1 	2) Frequency: 435.000MHz E,M4 Frequency: 444.000MHz K SSG output : -118dBm (0.28μV)±3dB						Check	One segment in S-meter lights. 
	<ul style="list-style-type: none"> • 430MHz band Full scale 							SSG output : -96dBm (3.54μV)±3dB
Band B <ul style="list-style-type: none"> • 144MHz band S1 	3) Frequency: 145.250MHz E,M4 Frequency: 146.250MHz K SSG MOD: 1kHz SSG DEV: 3kHz SSG output : -118dBm (0.28μV)±3dB						Check	One segment in S-meter lights. 
	<ul style="list-style-type: none"> • 144MHz band Full scale 							SSG output : -96dBm (3.54μV)±3dB
<ul style="list-style-type: none"> • 430MHz band S1 	4) Frequency: 435.000MHz E,M4 Frequency: 444.000MHz K SSG output : -118dBm (0.28μV)±3dB						Check	One segment in S-meter lights. 
	<ul style="list-style-type: none"> • 430MHz band Full scale 							SSG output : -96dBm (3.54μV)±3dB

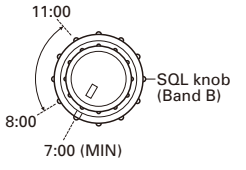

TM-D710A/D710E PC BOARD

DISPLAY UNIT (X54-3620-00) (A/4, B/4, C/4, D/4)
Component side view (J79-0141-09)

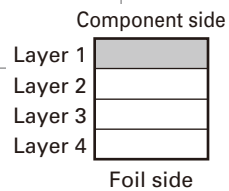
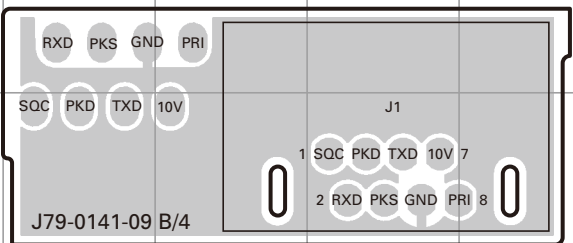
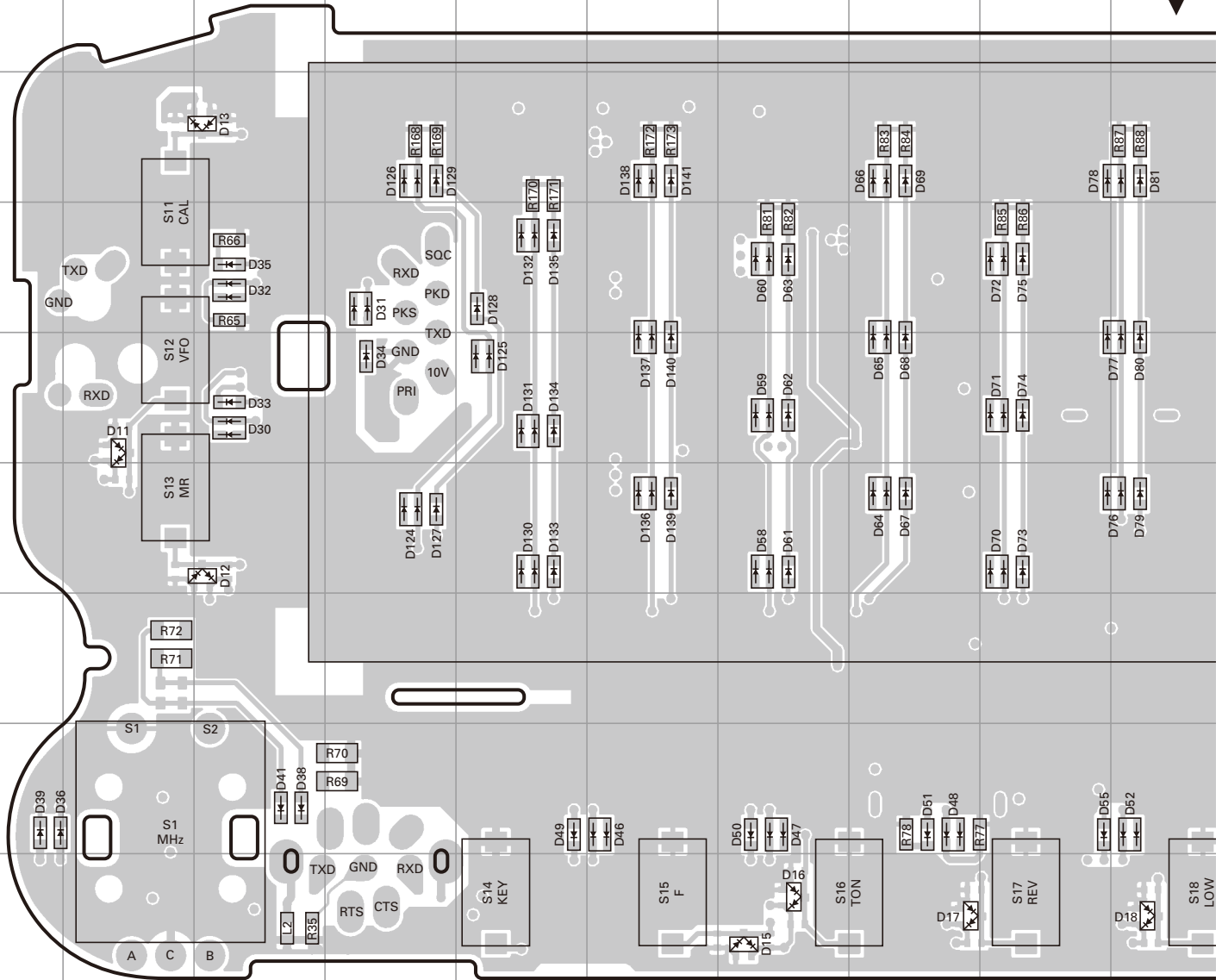

Ref. No.	Address	Ref. No.	Address	Ref. No.	Address	Ref. No.	Address	Ref. No.	Address
D11	5B	D28	10R	D46	8F	D62	5G	D78	3J
D12	6C	D29	10R	D47	8G	D63	4G	D79	6J
D13	3C	D30	5C	D48	8H	D64	6H	D80	5J
D15	9G	D31	4D	D49	8E	D65	5H	D81	3J
D16	9G	D32	4C	D50	8G	D66	3H	D82	6J
D17	9H	D33	5C	D51	8H	D67	6H	D83	5J
D18	9J	D34	5D	D52	8H	D68	5H	D84	4J
D19	9K	D35	4C	D53	8K	D69	3H	D85	6K
D20	9L	D36	8A	D54	8L	D70	6I	D86	5K
D21	3Q	D38	8C	D55	8I	D71	5I	D87	4K
D22	5R	D39	8A	D56	8K	D72	4I	D88	6K
D23	4R	D41	8C	D57	8L	D73	6I	D89	5K
D24	13R	D42	5Q	D58	6G	D74	5I	D90	3K
D25	13R	D43	4Q	D59	5G	D75	4I	D91	6L
D26	13R	D44	5Q	D60	4G	D76	6J	D92	5L
D27	10R	D45	4Q	D61	6G	D77	5J	D93	3L

PC BOARD TM-D710A/D710E

DISPLAY UNIT (X54-3620-00) (A/4, B/4, C/4, D/4)
Component side view (J79-0141-09)

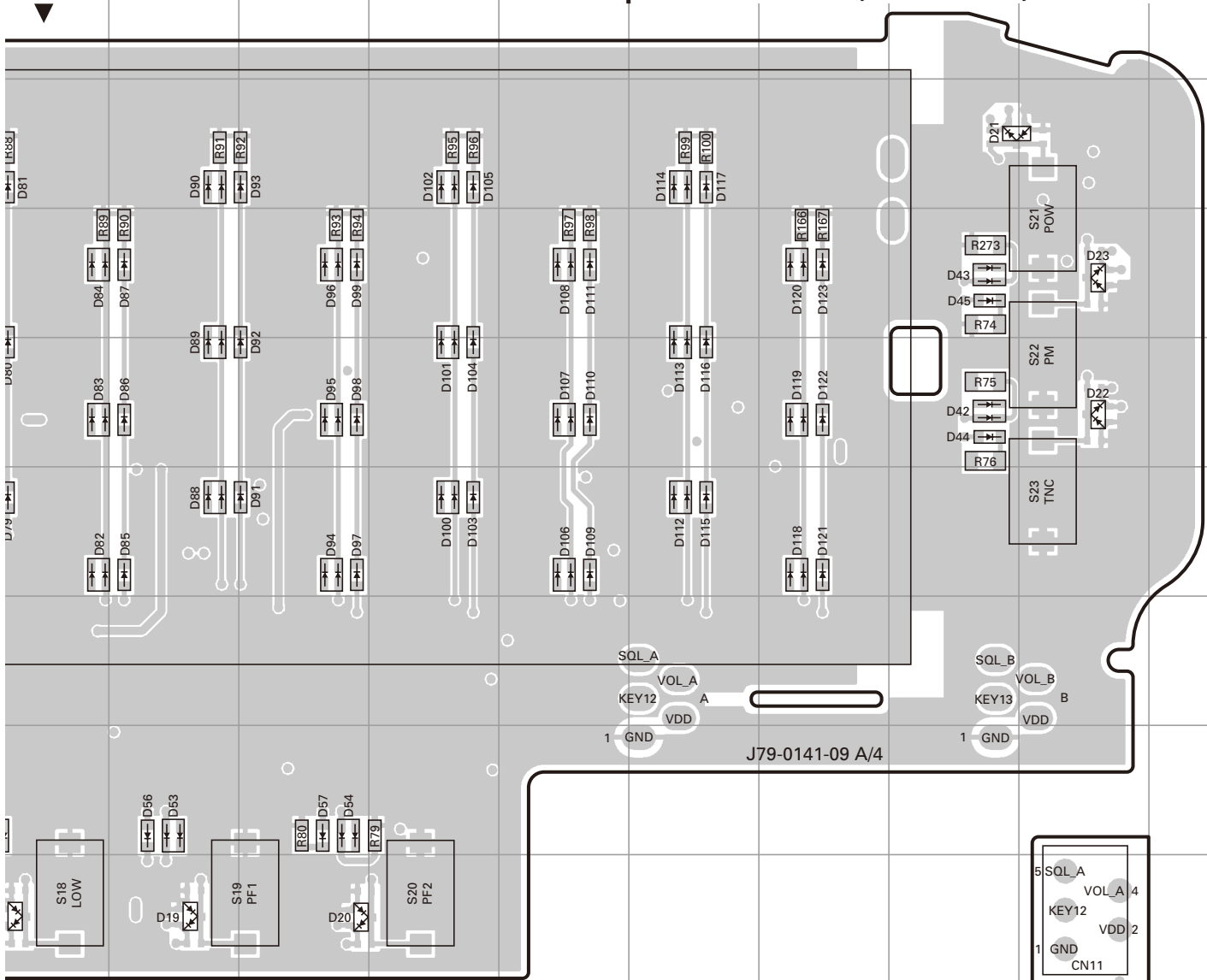

Address	Ref. No.	Address	Ref. No.	Address	Ref. No.	Address	Ref. No.
3J	D94	6L	D110	5N	D126	3D	
6J	D95	5L	D111	4N	D127	6D	
5J	D96	4L	D112	6O	D128	4E	
3J	D97	6L	D113	5O	D129	3D	
6J	D98	5L	D114	3O	D130	6E	
5J	D99	4L	D115	6O	D131	5E	
4J	D100	6M	D116	5O	D132	4E	
6K	D101	5M	D117	3O	D133	6E	
5K	D102	3M	D118	6P	D134	5E	
4K	D103	6M	D119	5P	D135	4E	
6K	D104	5M	D120	4P	D136	6F	
5K	D105	3M	D121	6P	D137	5F	
3K	D106	6N	D122	5P	D138	3F	
6L	D107	5N	D123	4P	D139	6F	
5L	D108	4N	D124	6D	D140	5F	
3L	D109	6N	D125	5E	D141	3F	

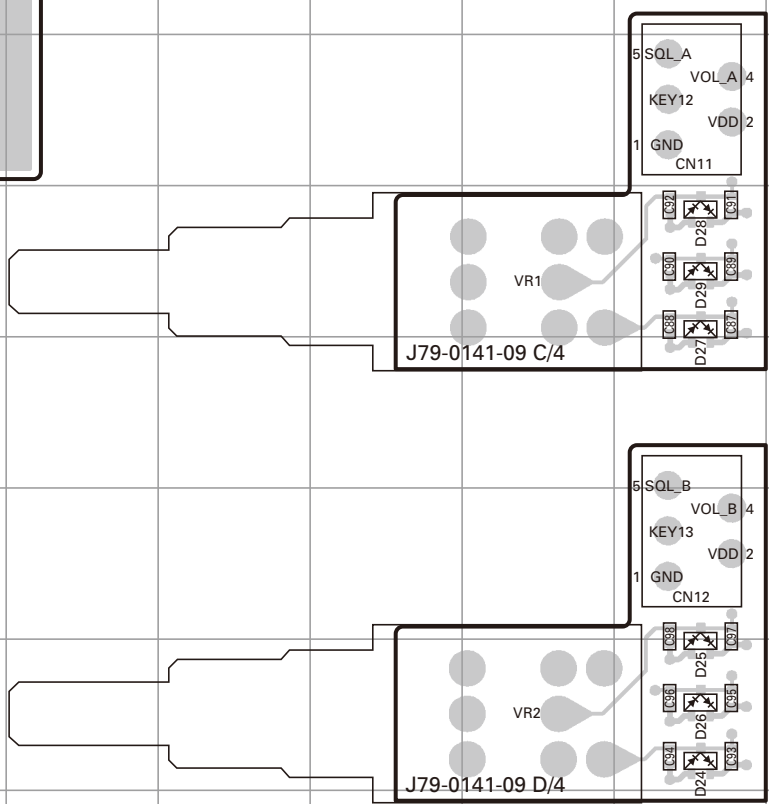

TM-D710A/D710E PC BOARD

DISPLAY UNIT (X54-3620-00) (A/4, B/4, C/4, D/4)

Foil side view (J79-0141-09)

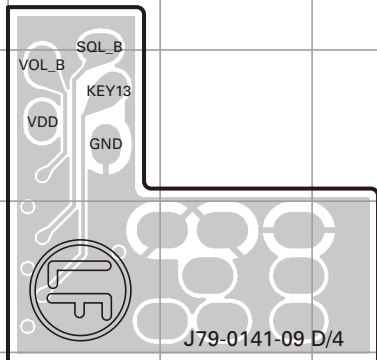
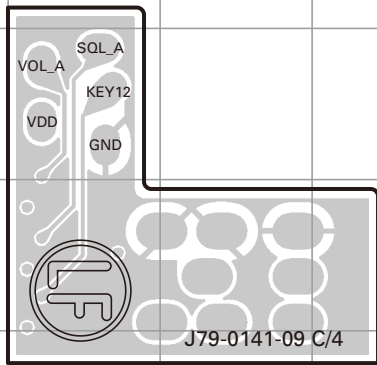
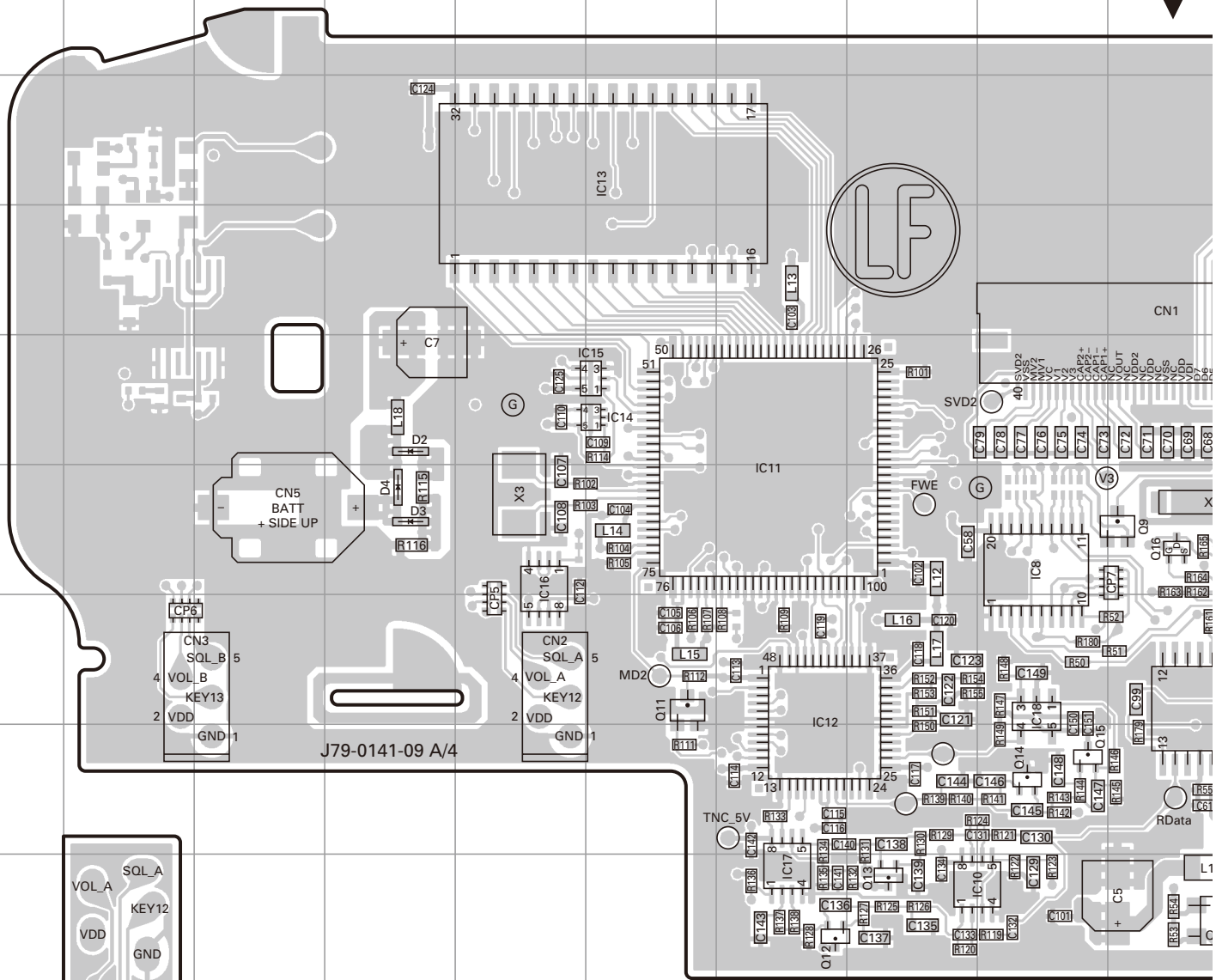

Ref. No.	Address	Ref. No.	Address	Ref. No.	Address	Ref. No.	Address
IC1	4M	IC16	6E	Q5	8L	D4	6D
IC2	6L	IC17	9G	Q6	9L	D8	9Q
IC3	6L	IC18	7I	Q7	8L	D9	9R
IC4	3O	IC19	6K	Q9	6J	D10	8R
IC5	3P	IC20	7J	Q10	5O	D14	9O
IC6	7N	IC21	3P	Q11	7F		
IC7	9N	IC22	3Q	Q12	9G		
IC8	6I	IC23	3R	Q13	9H		
IC10	9I	IC24	5O	Q14	8I		
IC11	6G	IC25	6K	Q15	8I		
IC12	7G	Q1	5N	Q16	6J		
IC13	3F	Q2	8M	D1	5O		
IC14	5F	Q3	9J	D2	5D		
IC15	5F	Q4	9K	D3	6D		

PC BOARD TM-D710A/D710E

DISPLAY UNIT (X54-3620-00) (A/4, B/4, C/4, D/4)
Foil side view (J79-0141-09)

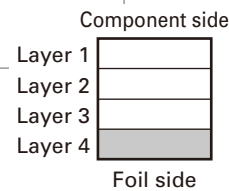
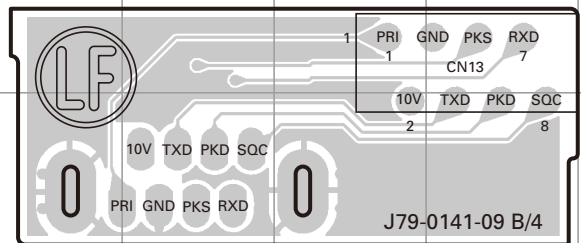
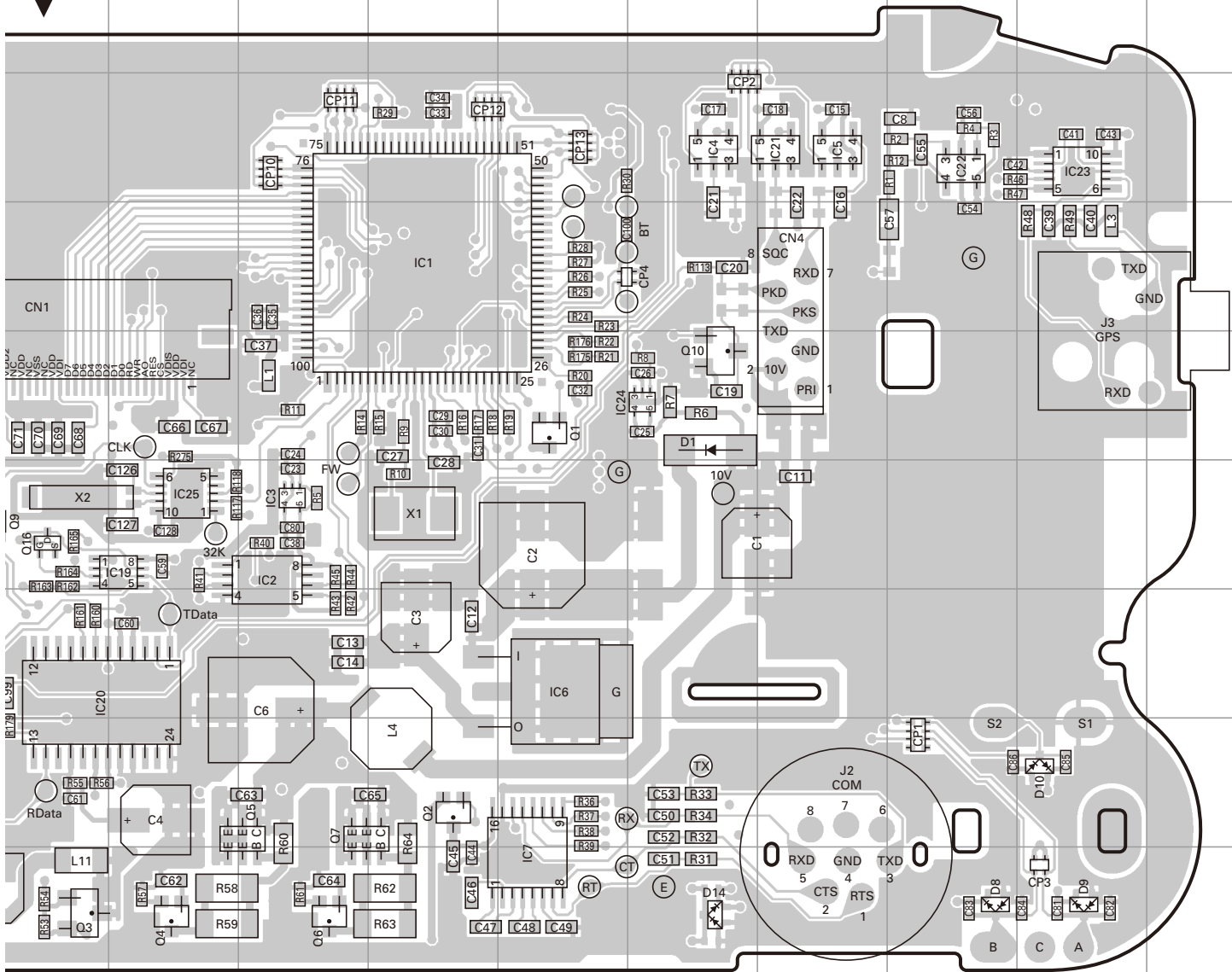

PC BOARD TM-D710A/D710E

**TX-RX UNIT
(X57-731X-XX)(A/6):
TX-RX SECTION
0-11 : K 0-21 : M4 2-71 : E
Component side view
(J79-0142-19 A/6)**

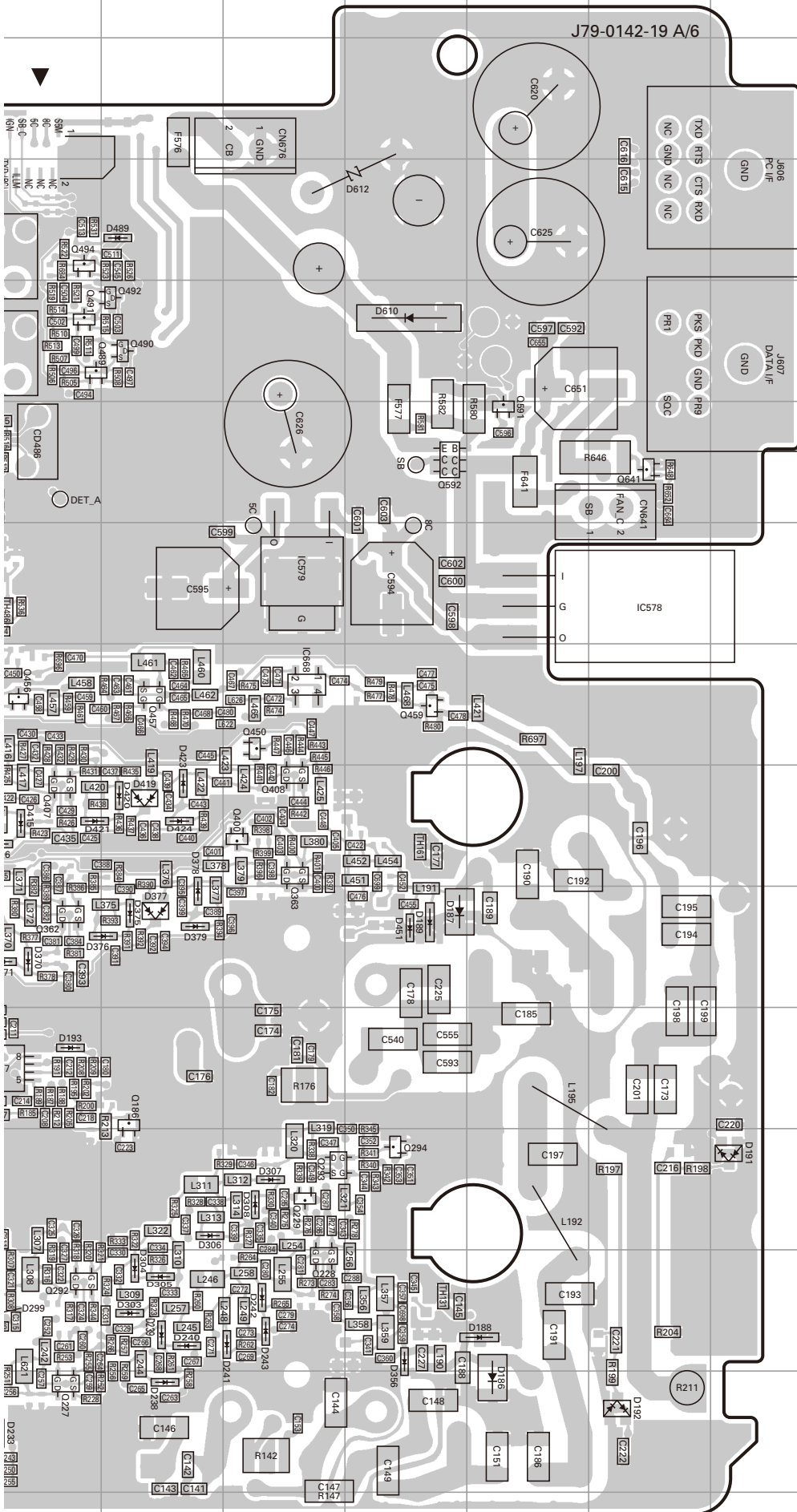

Ref. No.	Address	Ref. No.	Address
D188	12N	D361	6I
D189	9M	D362	9G
D190	10I	D363	9H
D191	11P	D364	9I
D192	13O	D365	9I
D193	10J	D367	9I
D226	6I	D368	9I
D227	12G	D370	9J
D229	12I	D371	9J
D230	12I	D375	9K
D231	12I	D376	9K
D232	13I	D377	9K
D233	13J	D378	9K
D234	13J	D379	9K
D238	13K	D406	6H
D239	12K	D407	7G
D240	12K	D408	7H
D241	12L	D409	8I
D242	12L	D410	8I
D243	12L	D412	8I
D291	6H	D413	8I
D292	11G	D415	8J
D294	11I	D416	8J
D295	11I	D419	8K
D296	11I	D420	8K
D297	12I	D421	8J
D298	12J	D423	8K
D299	12J	D424	8K
D303	12K	D451	9M
D304	12K	D456	6H
D305	12K	D457	7G
D306	11K	D489	3K
D307	11L	D610	4M
D308	11L	D612	3M
D356	12M		

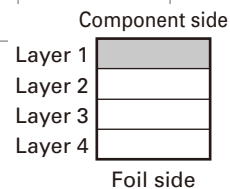

TM-D710A/D710E PC BOARD

TX-RX UNIT
(X57-731X-XX)(A/6):
TX-RX SECTION
0-11 : K 0-21 : M4 2-71 : E
Foil side view
(J79-0142-19 A/6)

Ref. No.	Address	Ref. No.	Address
IC131	11I	Q576	4N
IC161	8I	Q580	4I
IC186	10J	Q606	4E
IC486	5J	Q607	4F
IC487	4I	Q642	4G
IC546	5L	Q644	13M
IC576	5O	D1	13N
IC577	5N	D3	13P
IC606	3E	D24	11M
IC666	3M	D66	8O
IC667	3N	D68	8N
Q1	13P	D69	9O
Q3	13O	D130	13M
Q6	12O	D131	13M
Q8	9N	D132	13M
Q9	9O	D133	13K
Q66	8N	D134	13F
Q68	8N	D135	13F
Q69	9O	D136	12F
Q71	9N	D162	10L
Q73	12O	D163	10K
Q74	12O	D164	9F
Q131	13L	D165	9F
Q132	13K	D166	9G
Q161	10L	D486	4K
Q162	10L	D487	4J
Q163	10K	D488	3J
Q486	4J	D546	4M
Q487	4J	D547	4K
Q488	5J	D576	7N
Q495	5K	D578	7N
Q496	3I	D580	7N
Q546	4L	D582	6O
Q547	5M	D583	6O
Q548	4L	D584	6N
Q549	6L	D606	4E
Q551	6L	D607	4E
Q572	5M	D608	5F
Q573	5N	D609	4E
Q574	5N	D611	3H
Q575	5N		

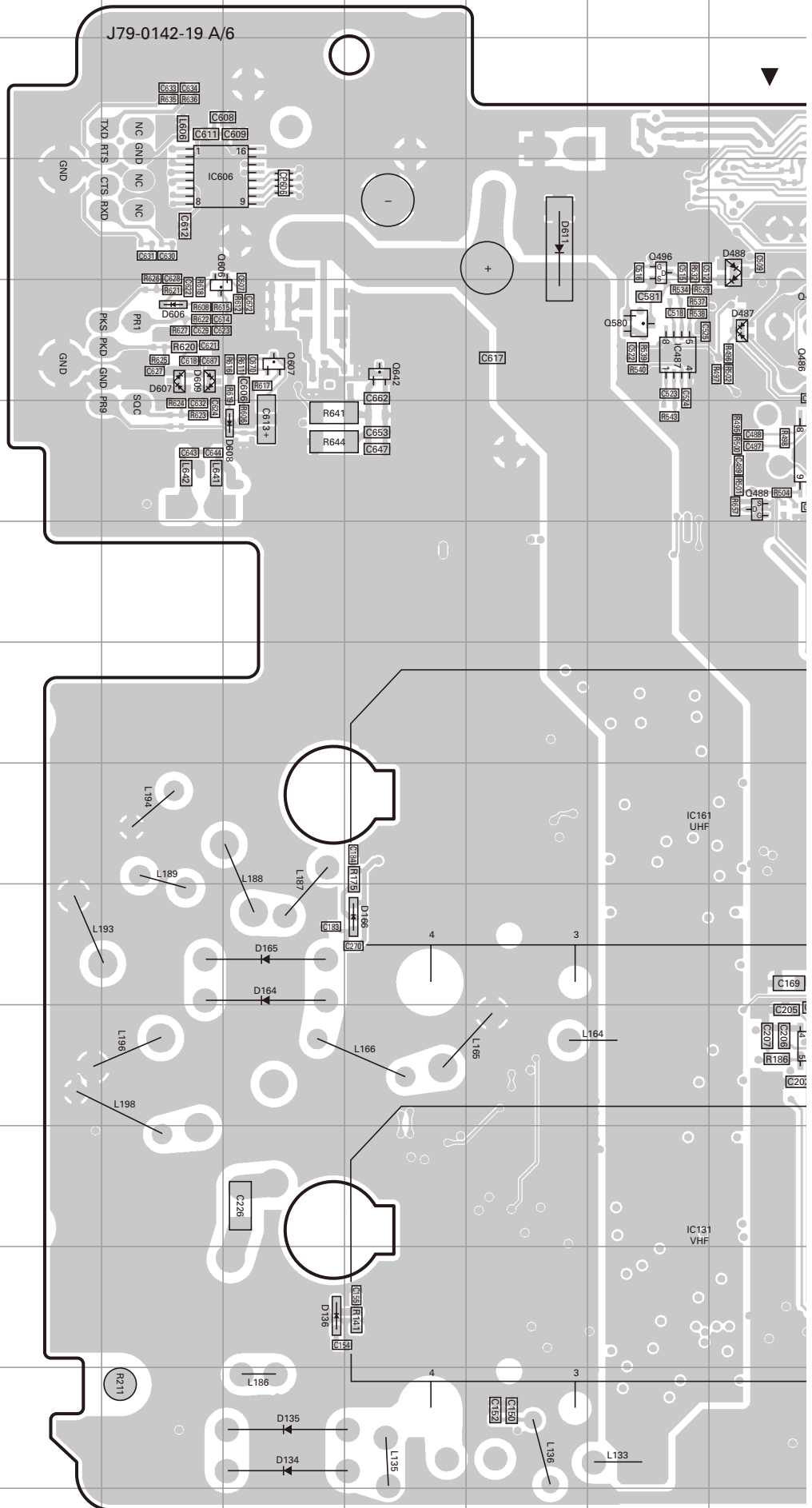

PC BOARD TM-D710A/D710E

**TX-RX UNIT
(X57-731X-XX)(A/6):
TX-RX SECTION
0-11 : K 0-21 : M4 2-71 : E
Foil side view
(J79-0142-19 A/6)**

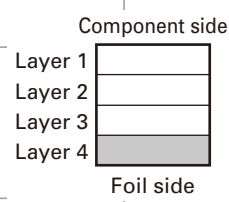
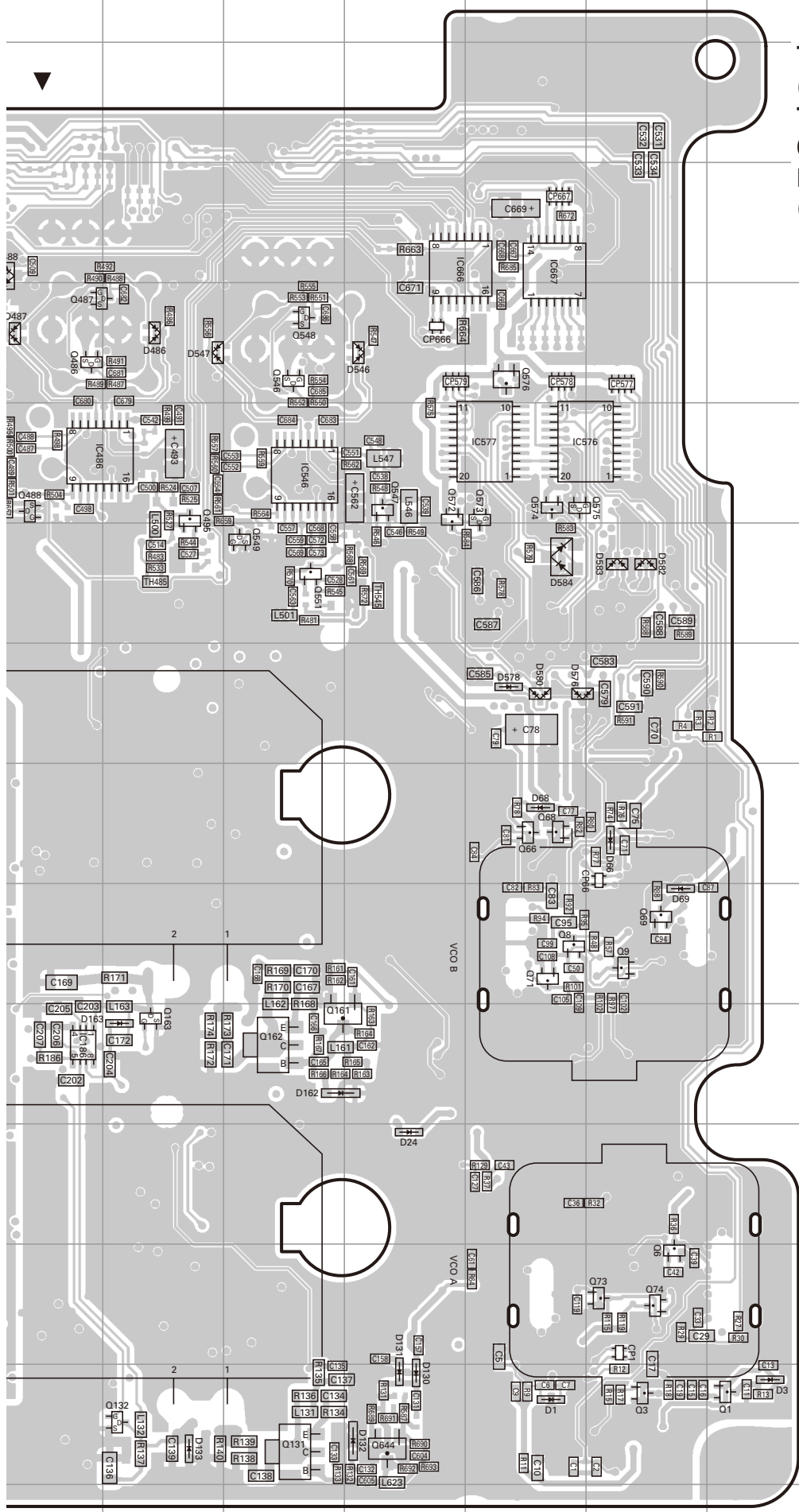

TM-D710A/D710E PC BOARD

TX-RX UNIT (X57-731X-XX) (D/6) : CONTROL SECTION

0-11 : K 0-21 : M4 2-71 : E Component side view (J79-0142-19 D/6)

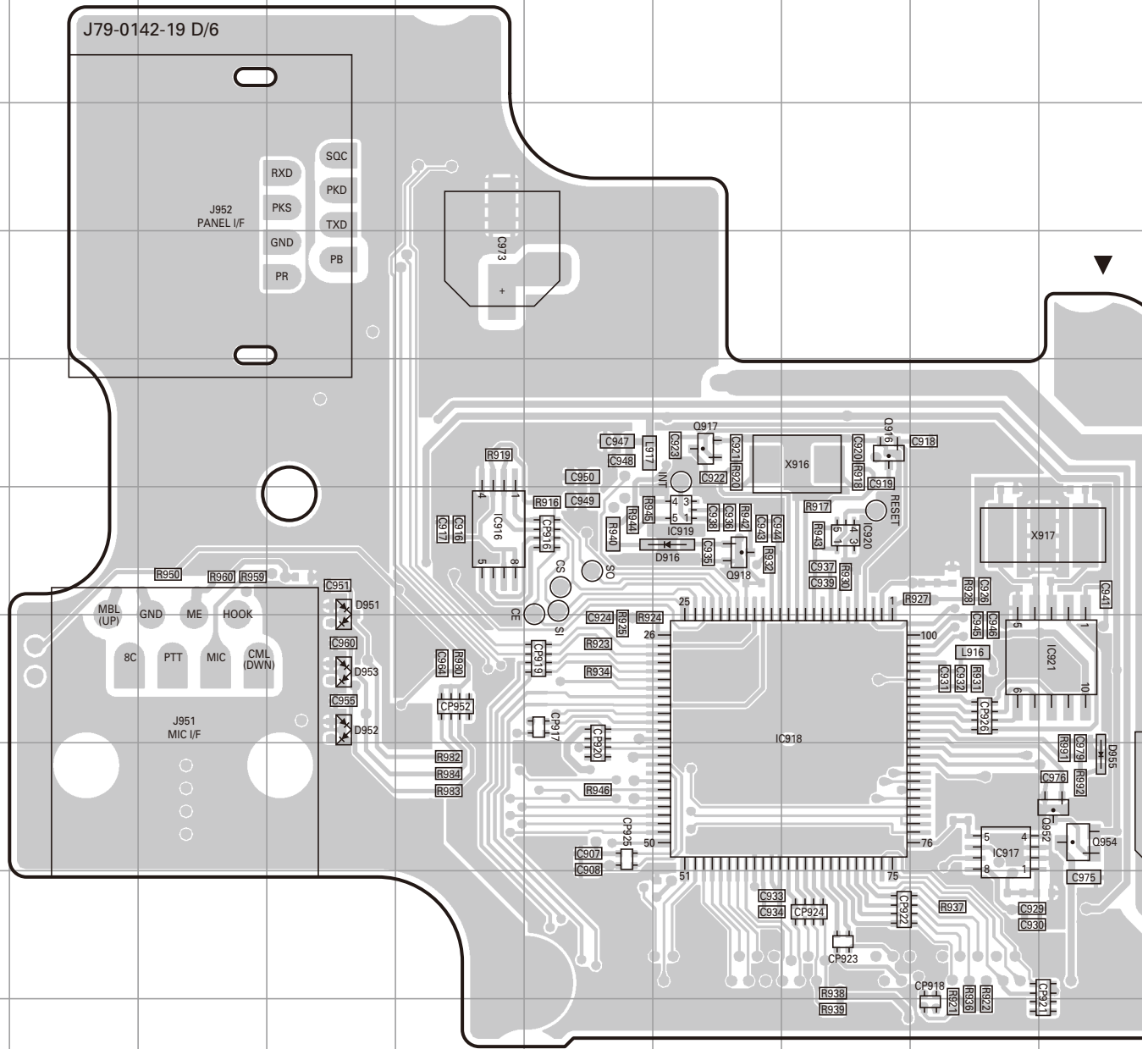

TX-RX UNIT (E/6) :
VCO A SECTION

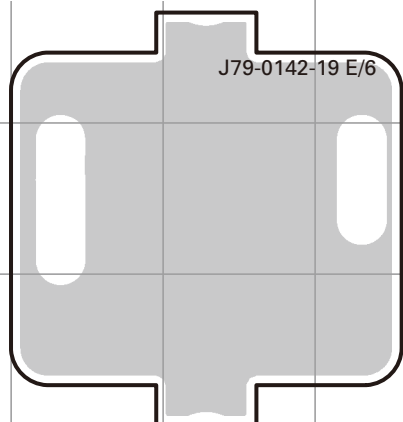

TX-RX UNIT (B/6) :
VCO A SECTION

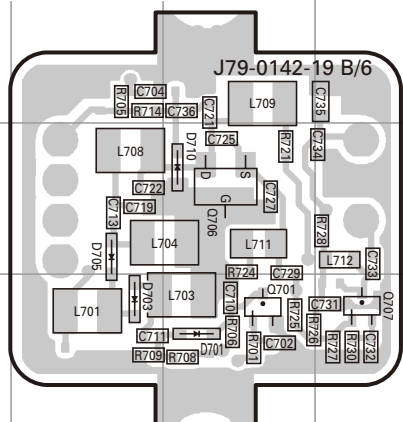

TX-RX UNIT (C/6) :
VCO B SECTION

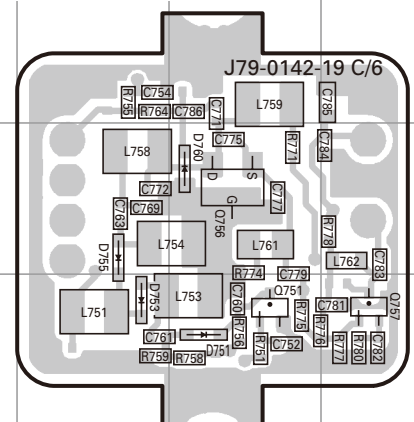

PC BOARD TM-D710A/D710E

TX-RX UNIT (X57-731X-XX) (D/6) : CONTROL SECTION

0-11 : K 0-21 : M4 2-71 : E Component side view (J79-0142-19 D/6)

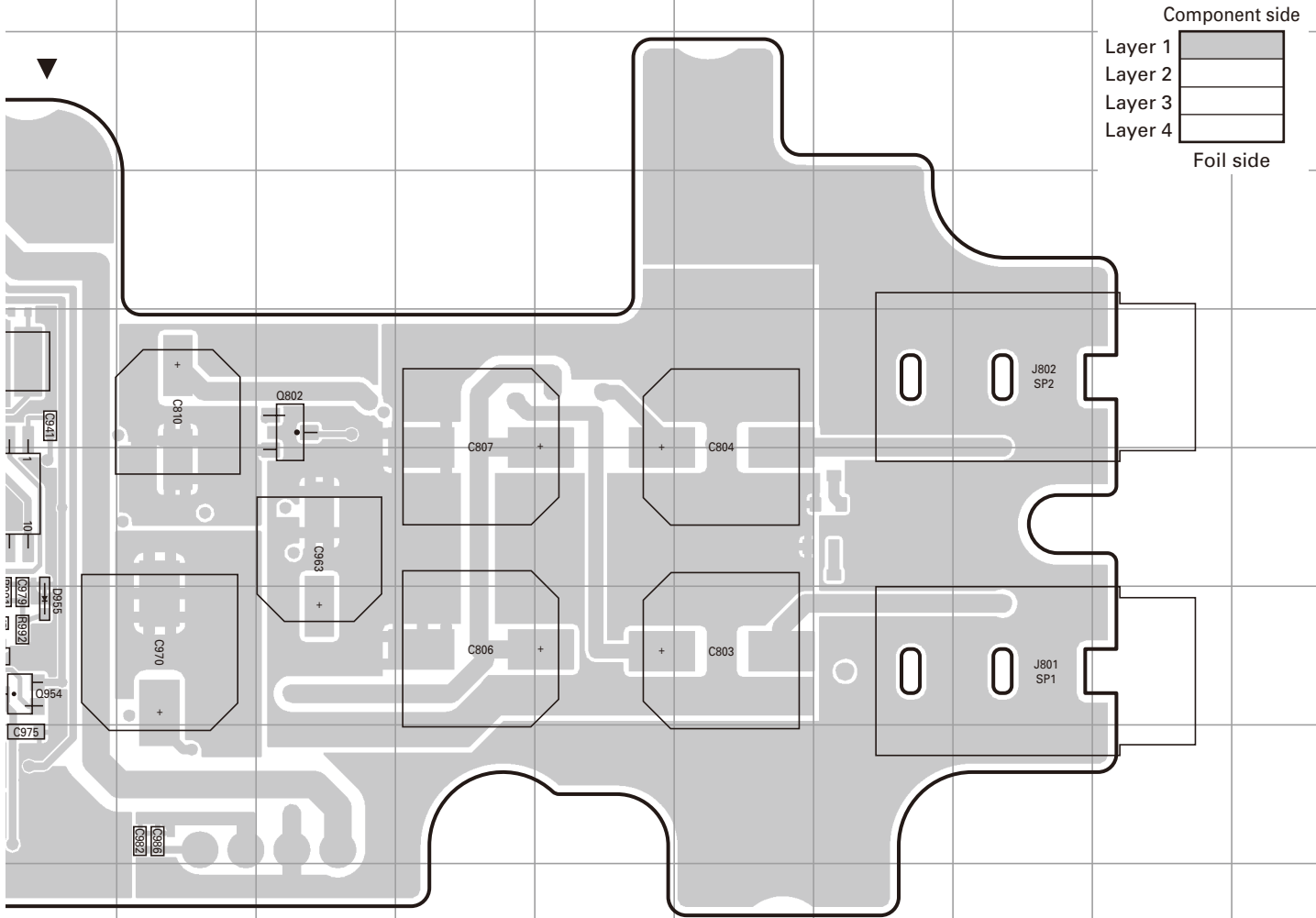

TX-RX UNIT (F/6) :
VCO B SECTION

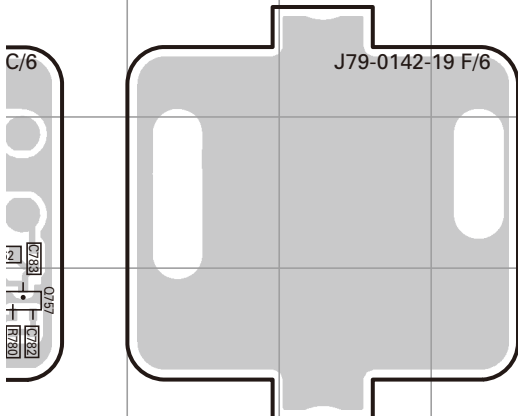

Ref. No.	Address	Ref. No.	Address	Ref. No.	Address
IC916	6E	Q757	13J	D751	13I
IC917	8I	Q802	6L	D753	13H
IC918	7H	Q916	5H	D755	12H
IC919	6G	Q917	5G	D760	12I
IC920	6H	Q918	6G	D916	6G
IC921	7J	Q952	8J	D951	6D
Q701	13F	Q954	8J	D952	7D
Q706	12F	D701	13F	D953	7D
Q707	13G	D703	13E	D955	8J
Q751	13I	D705	12E		
Q756	12I	D710	12F		

TM-D710A/D710E PC BOARD

TX-RX UNIT (X57-731X-XX) (D/6) : CONTROL SECTION

0-11 : K 0-21 : M4 2-71 : E Foil side view (J79-0142-19 D/6)

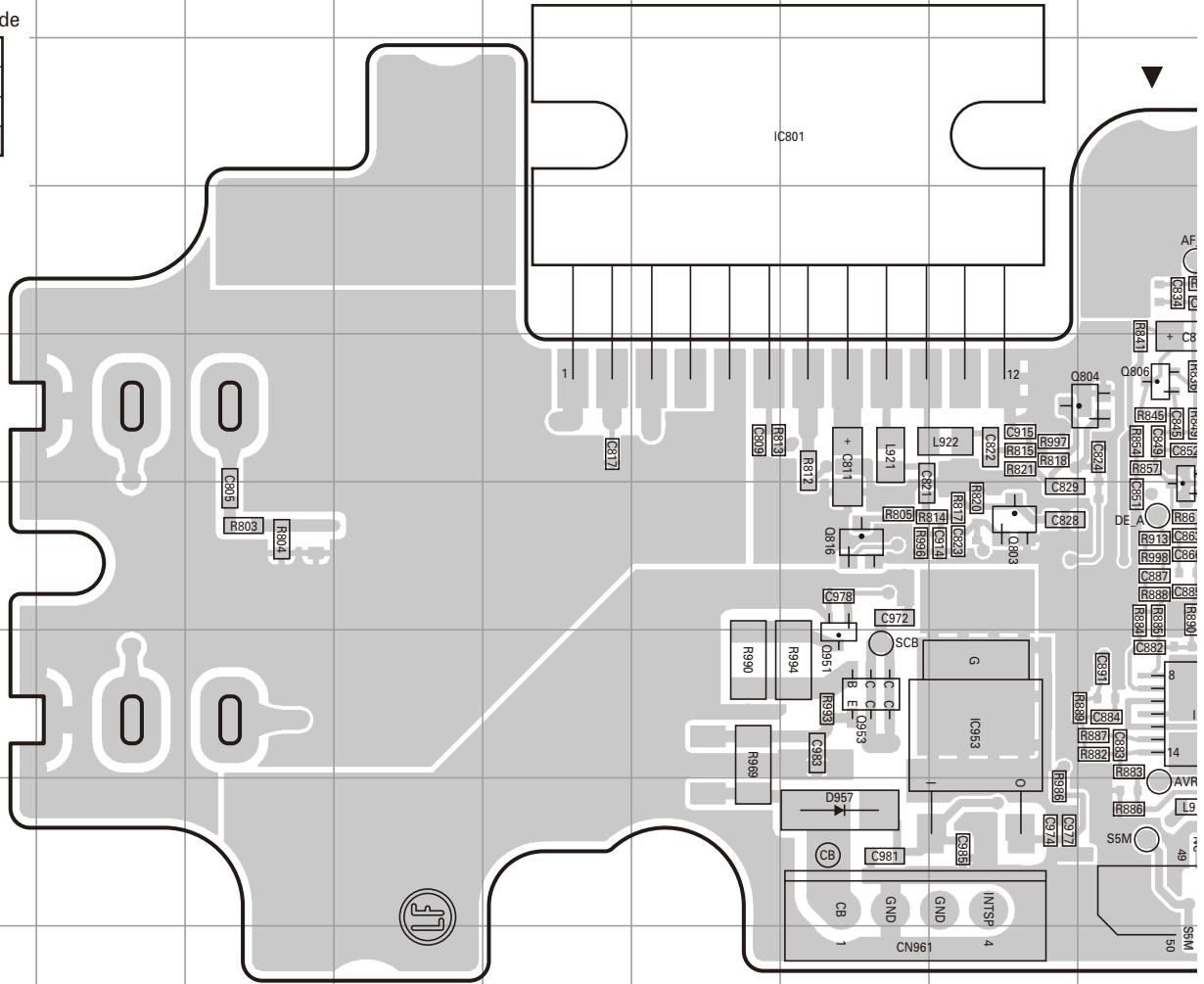
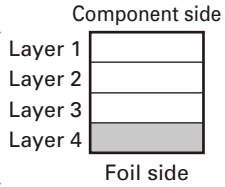

TX-RX UNIT (F/6) :
VCO B SECTION

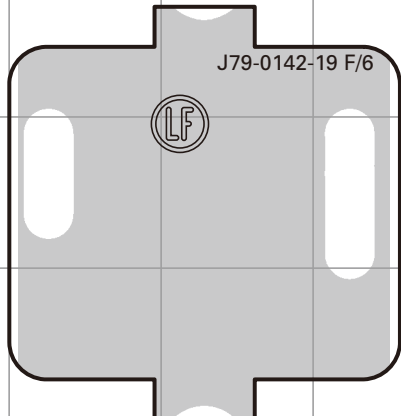

TX-RX UNIT (C/6) :
VCO B SECTION

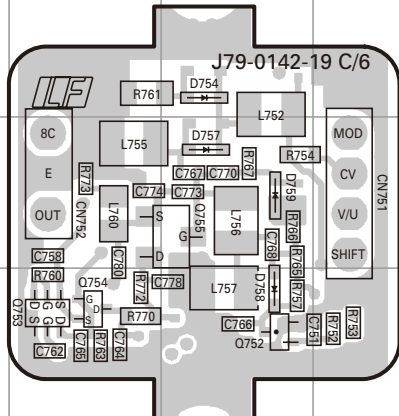

TX-RX UNIT (B/6) :
VCO A SECTION

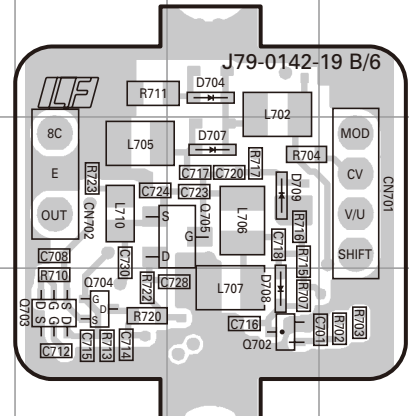

PC BOARD TM-D710A/D710E

TX-RX UNIT (X57-731X-XX) (D/6) : CONTROL SECTION

0-11 : K 0-21 : M4 2-71 : E Foil side view (J79-0142-19 D/6)

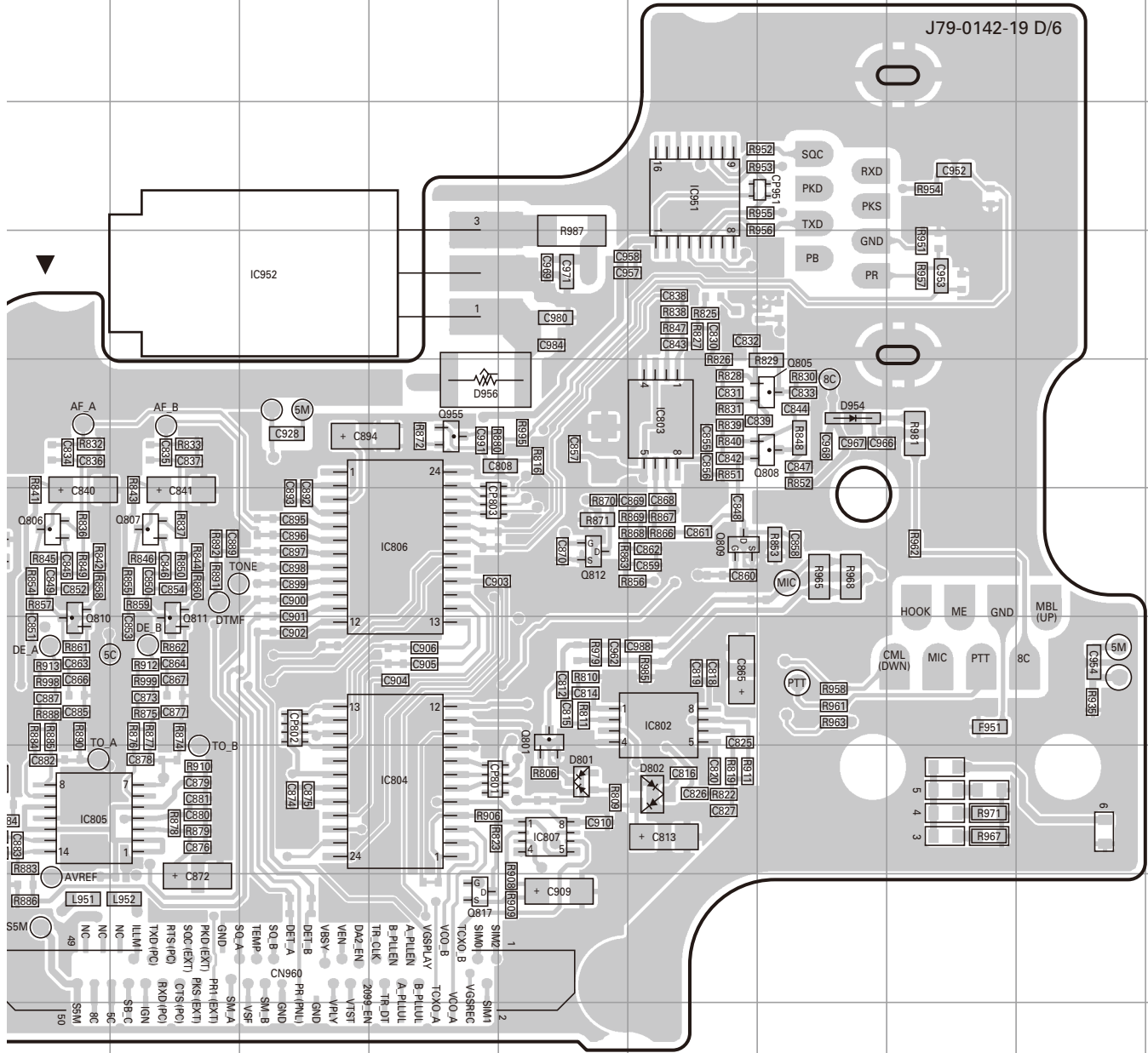

TX-RX UNIT (E/6) : VCO A SECTION

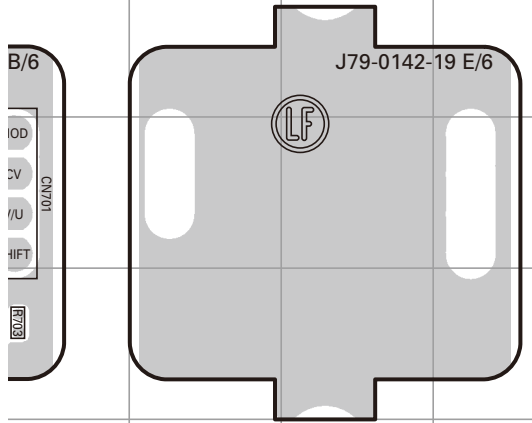

Ref. No.	Address	Ref. No.	Address	Ref. No.	Address	Ref. No.	Address
IC801	4H	Q704	13H	Q808	5P	D708	13I
IC802	7O	Q705	12I	Q809	6O	D709	12I
IC803	5O	Q752	13F	Q810	7J	D754	11F
IC804	8M	Q753	13E	Q811	7K	D757	12F
IC805	8J	Q754	13E	Q812	6N	D758	13F
IC806	6M	Q755	12F	Q816	7H	D759	12F
IC807	8N	Q801	7N	Q817	9M	D801	8N
IC951	3O	Q803	7I	Q951	8H	D802	8O
IC952	4L	Q804	6J	Q953	8H	D954	5P
IC953	8I	Q805	5P	Q955	5M	D956	5M
Q702	13I	Q806	6J	D704	11I	D957	9H
Q703	13H	Q807	6K	D707	12I		

TM-D710A/D710E

INTERCONNECTION DIAGRAM

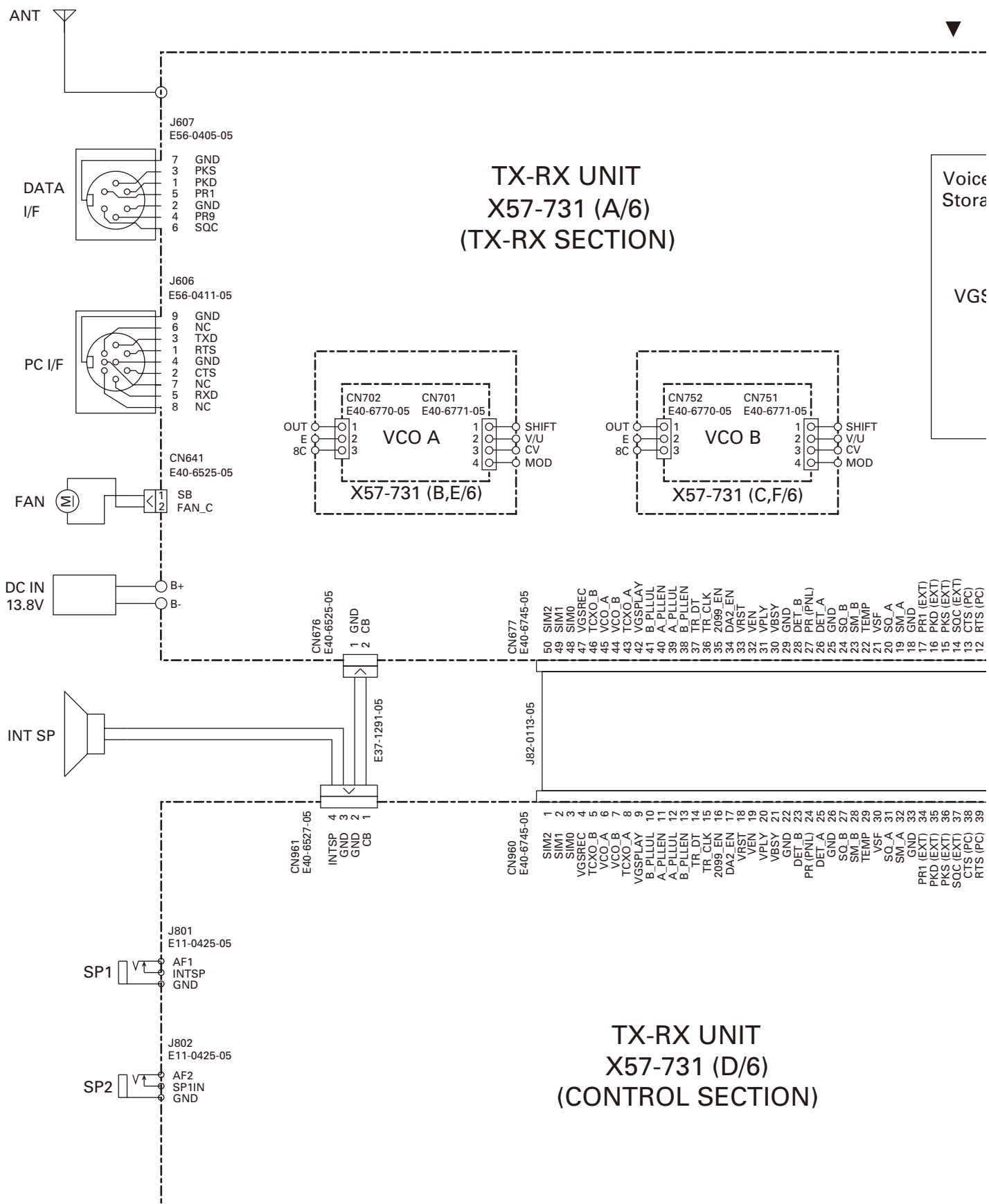

INTERCONNECTION DIAGRAM

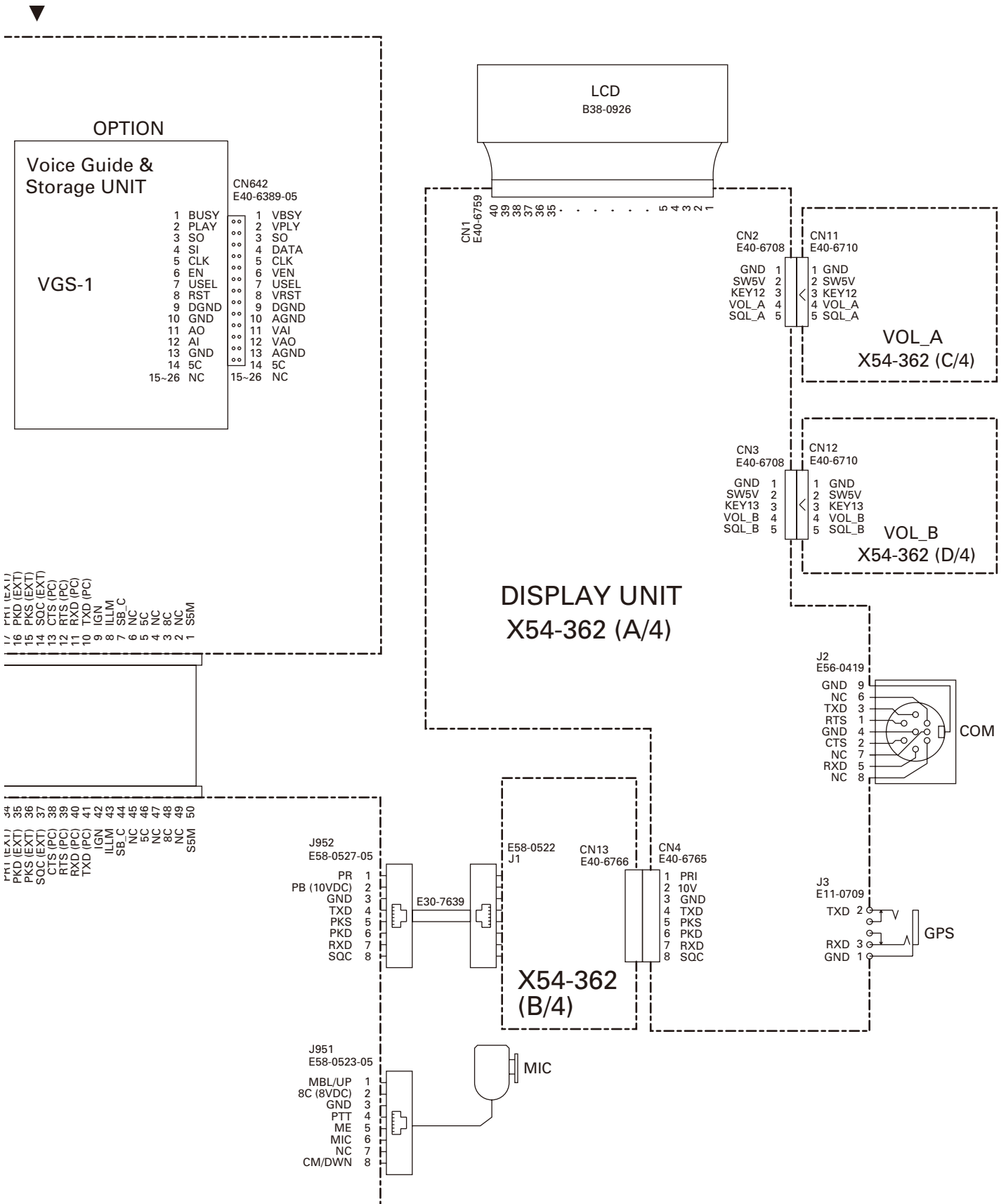

TM-D710A/D710E SCHEMATIC DIAGRAM

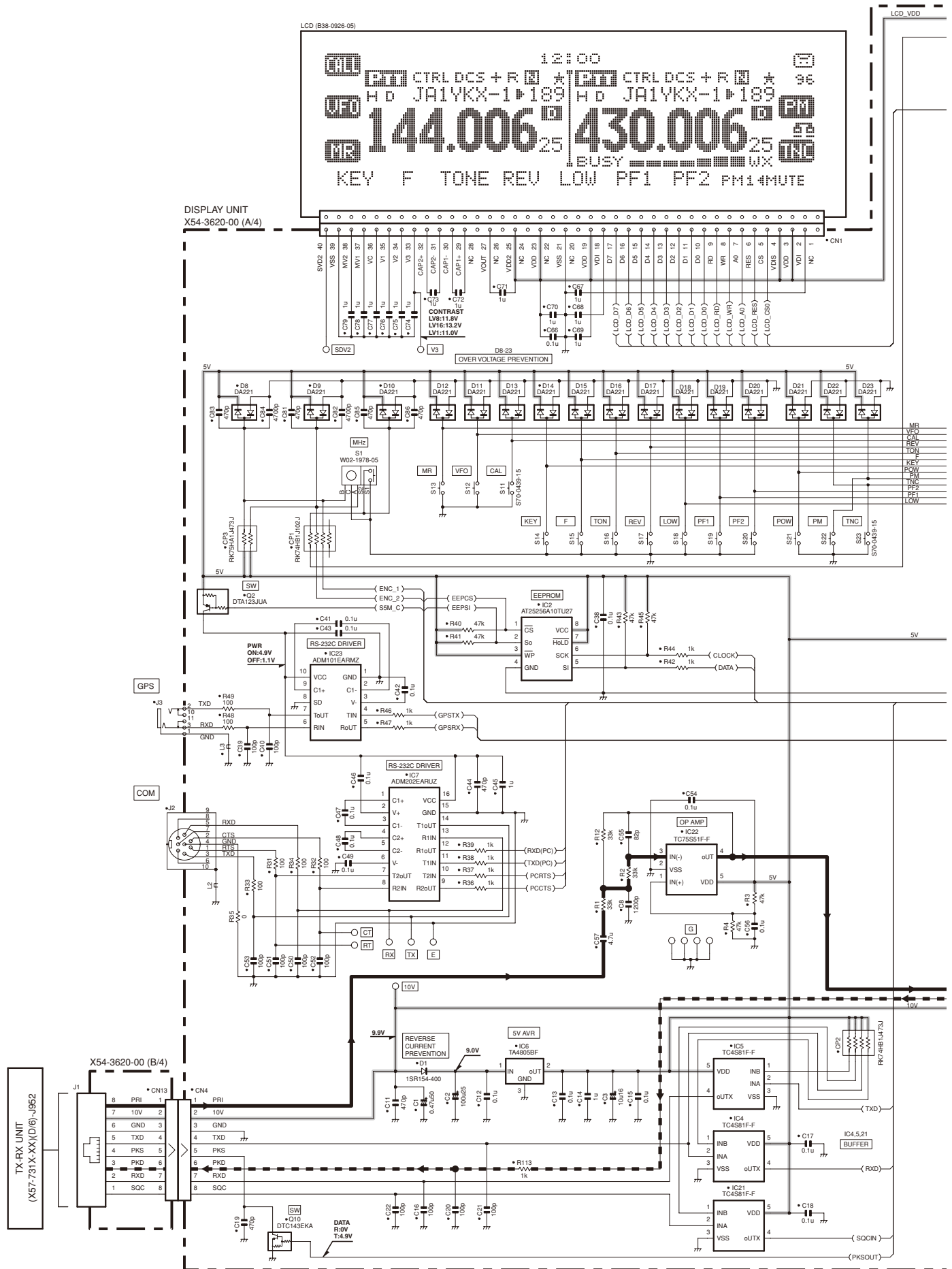

SCHEMATIC DIAGRAM TM-D710A/D710E

DISPLAY UNIT (X54-3620-00) (A/4)

LCD_VDD

LCD_VDD

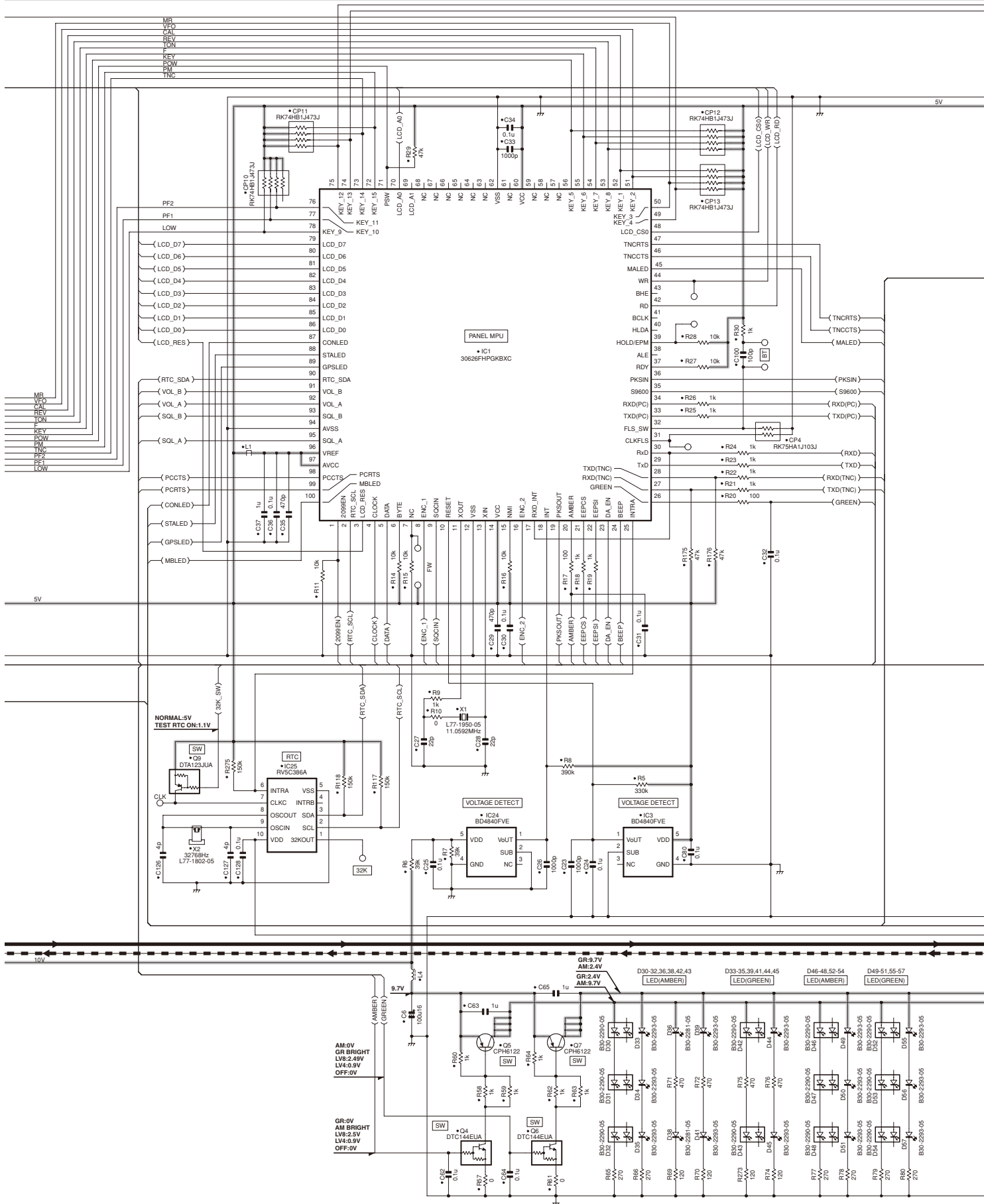

TM-D710A/D710E SCHEMATIC DIAGRAM

DISPLAY UNIT (X54-3620-00) (A/4)

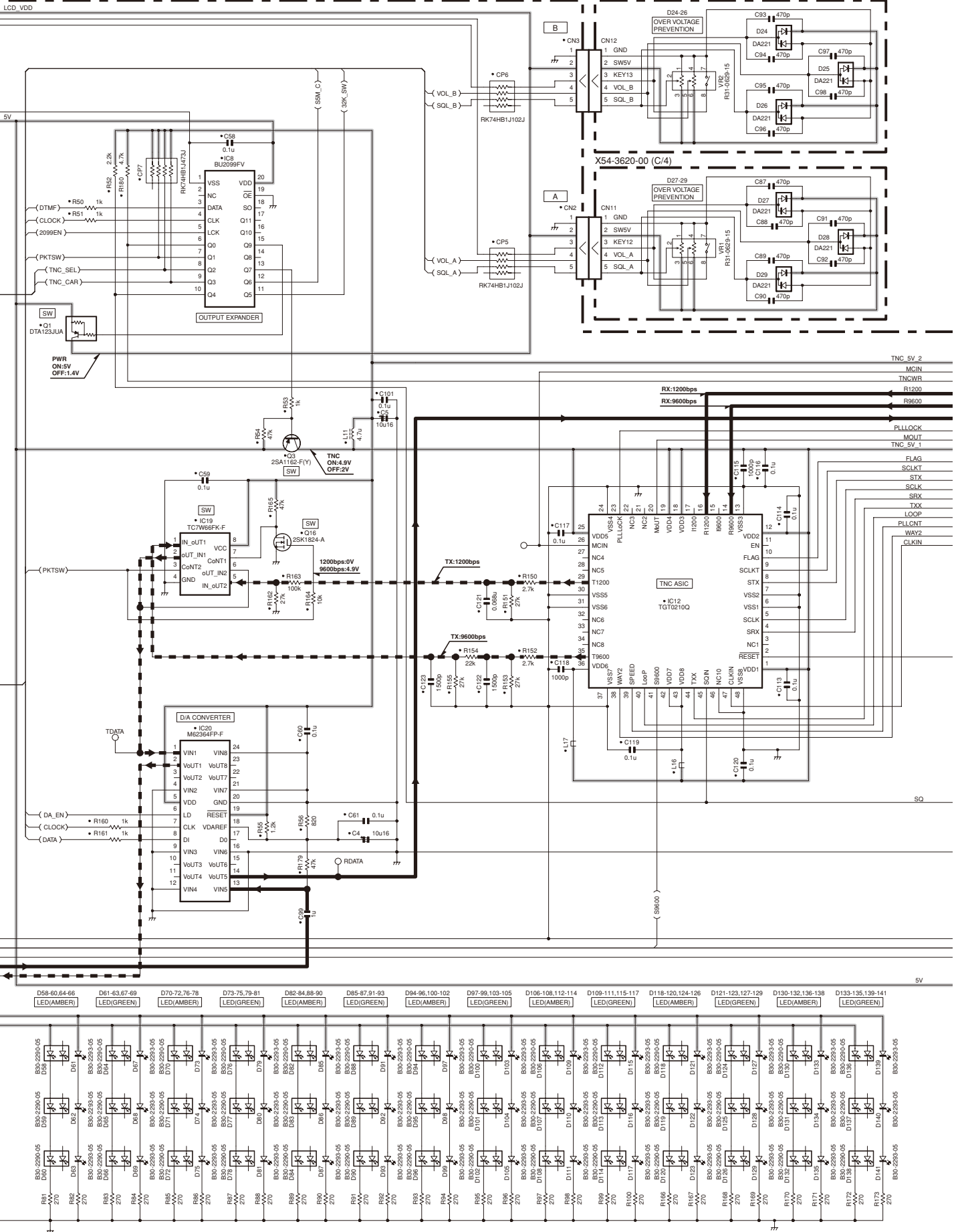

SCHEMATIC DIAGRAM TM-D710A/D710E

DISPLAY UNIT (X54-3620-00) (A/4)

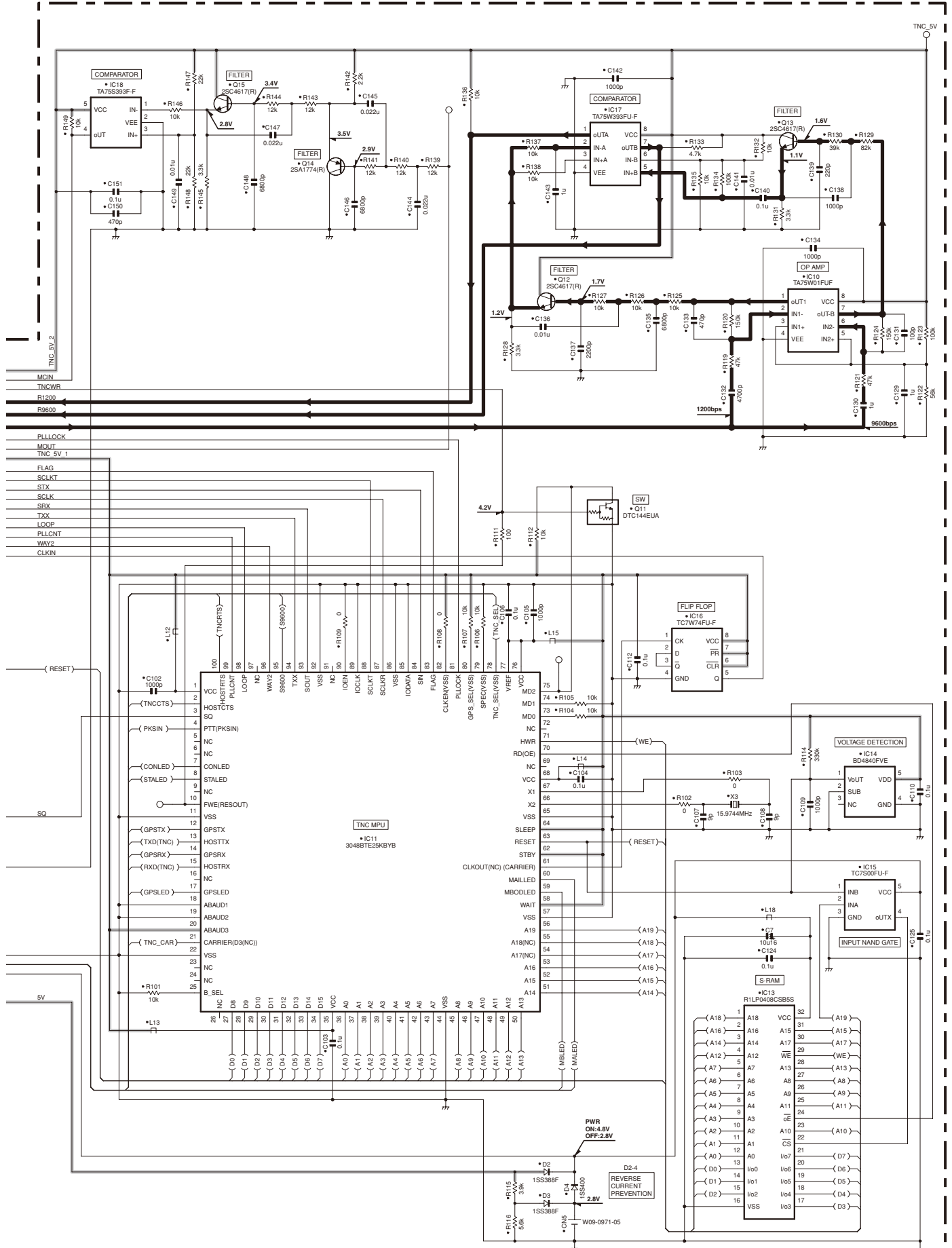

Note : The components marked with a dot (•) are parts of layer 1.

TM-D710A/D710E SCHEMATIC DIAGRAM

TX-RX UNIT (X57-731X-XX)(A/6) : TX-RX SECTION

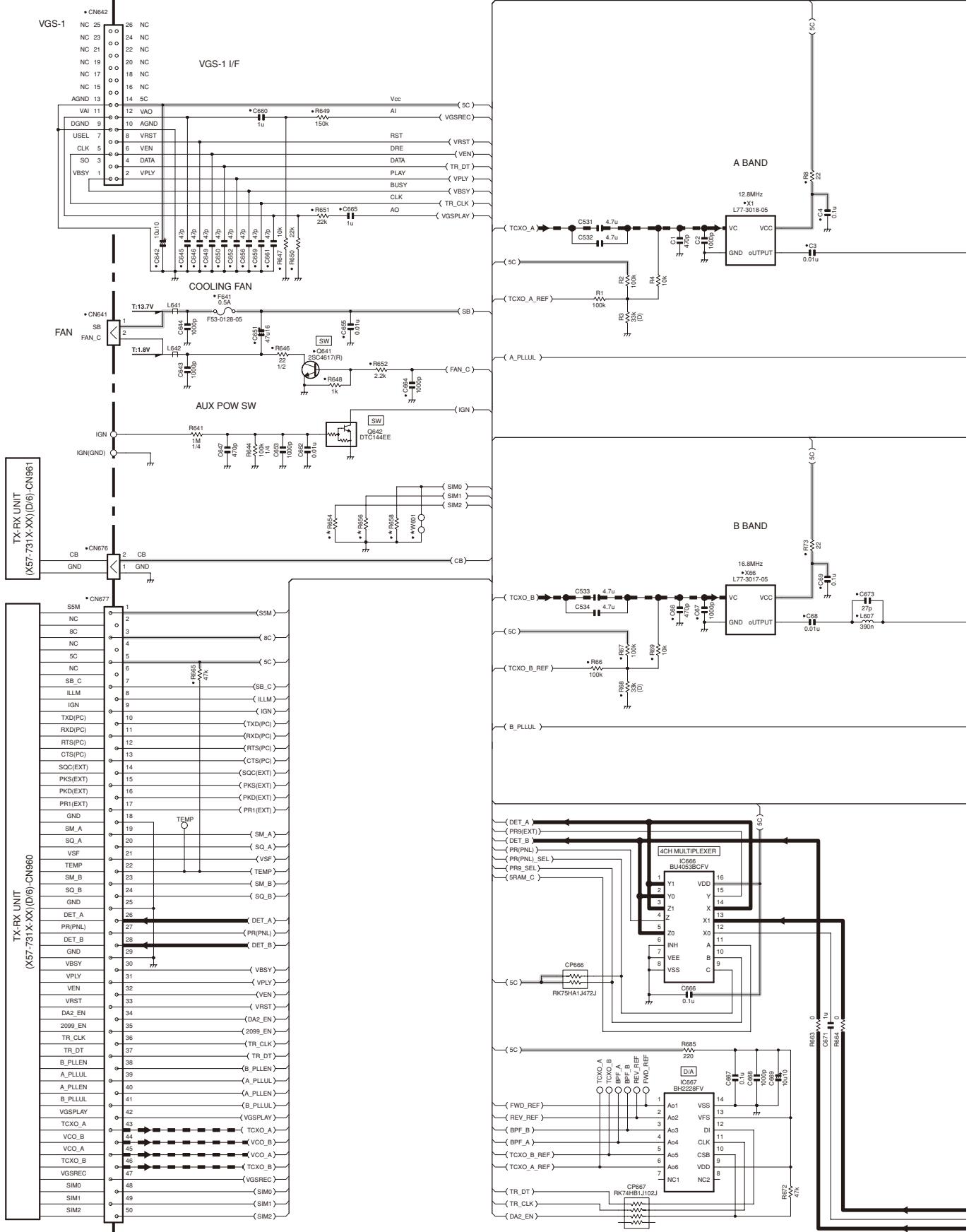

X57-731X-XX	R654	R656	R658	W601
0-11	K	0	0	NO
2-71	E	NO	NO	0
0-21	M4	NO	0	NO

SCHEMATIC DIAGRAM TM-D710A/D710E

TX-RX UNIT (X57-731X-XX) (A/6): TX-RX SECTION

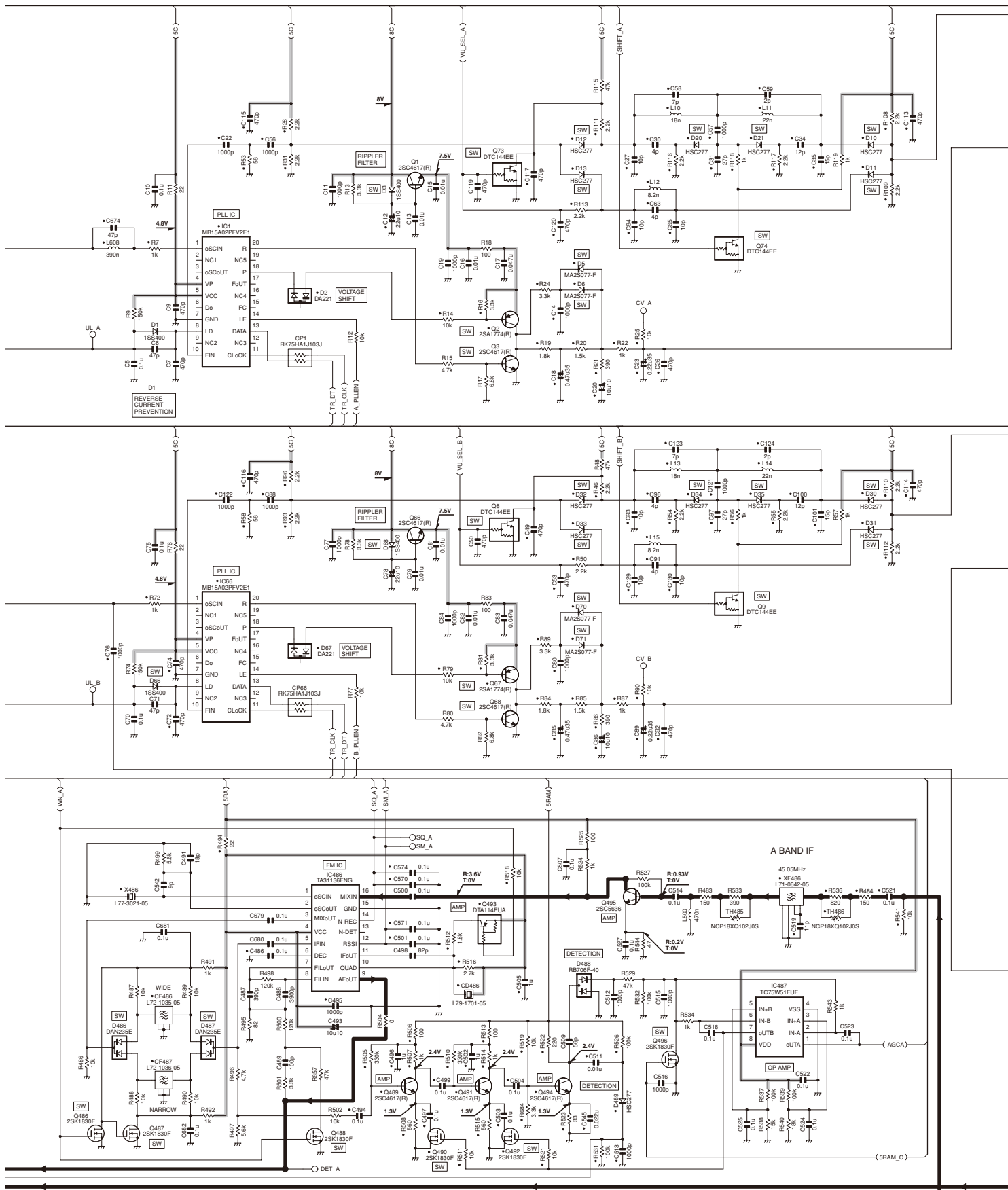

TM-D710A/D710E SCHEMATIC DIAGRAM

TX-RX UNIT (X57-731-XX) (A/6): TX-RX SECTION

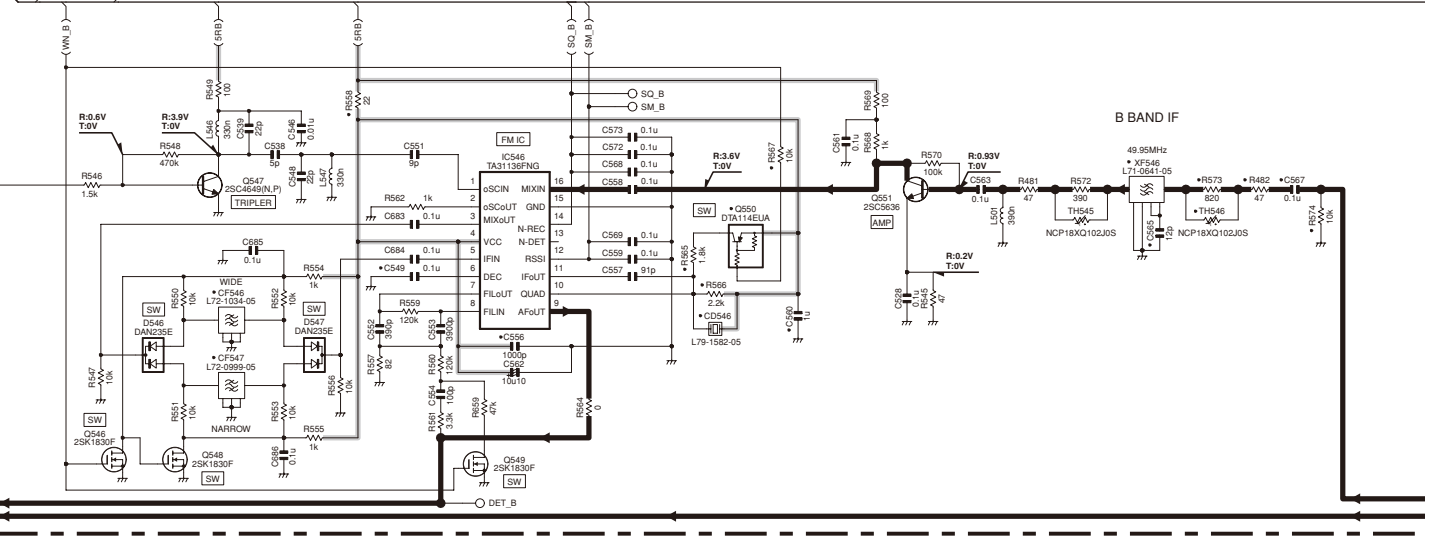
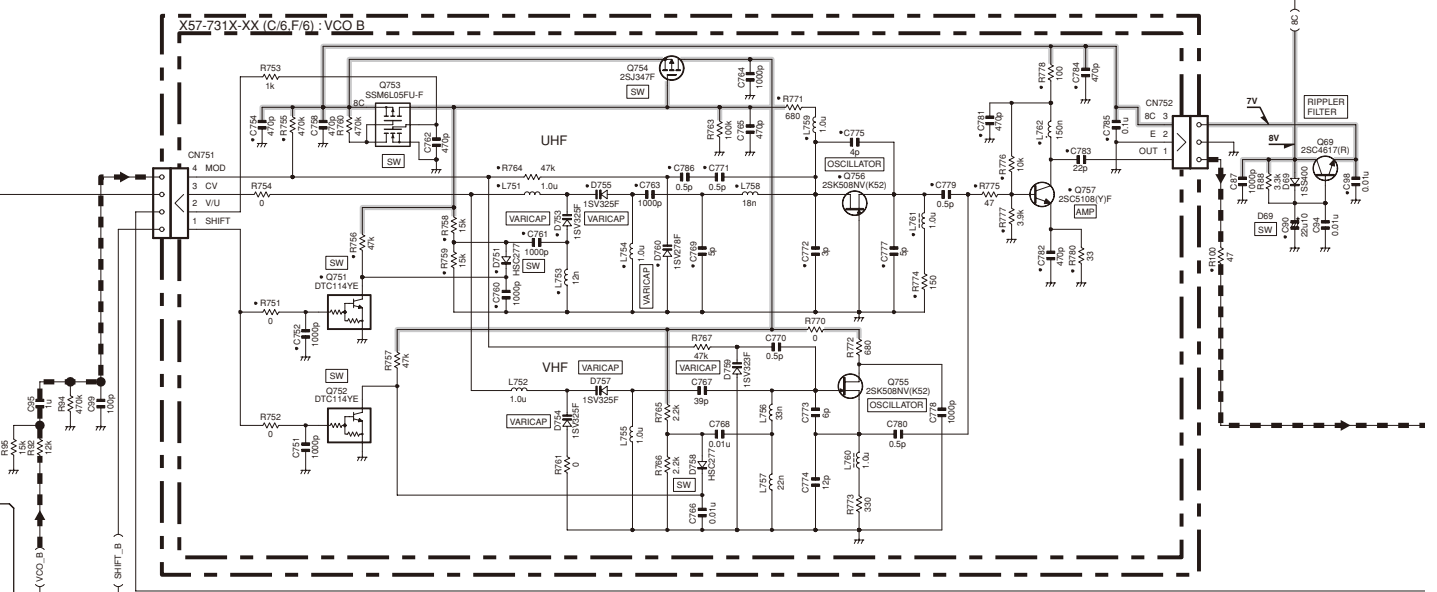
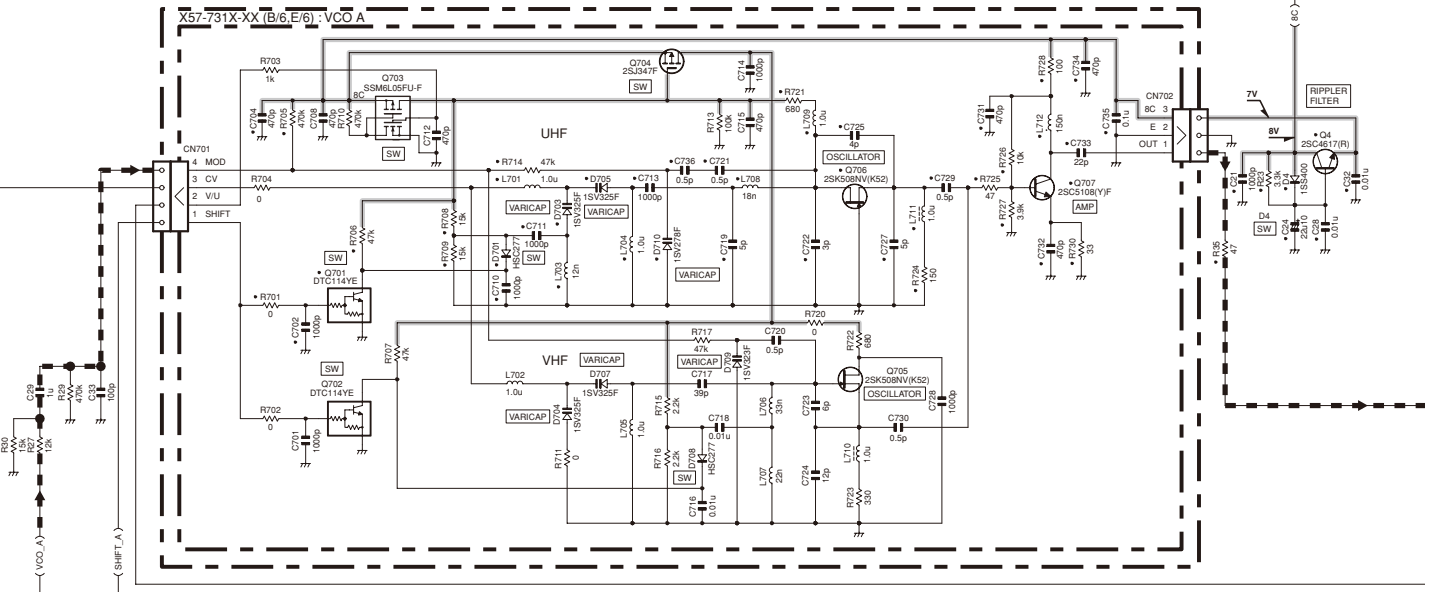

SCHEMATIC DIAGRAM TM-D710A/D710E

TX-RX UNIT (X57-731X-XX) (A/6): TX-RX SECTION

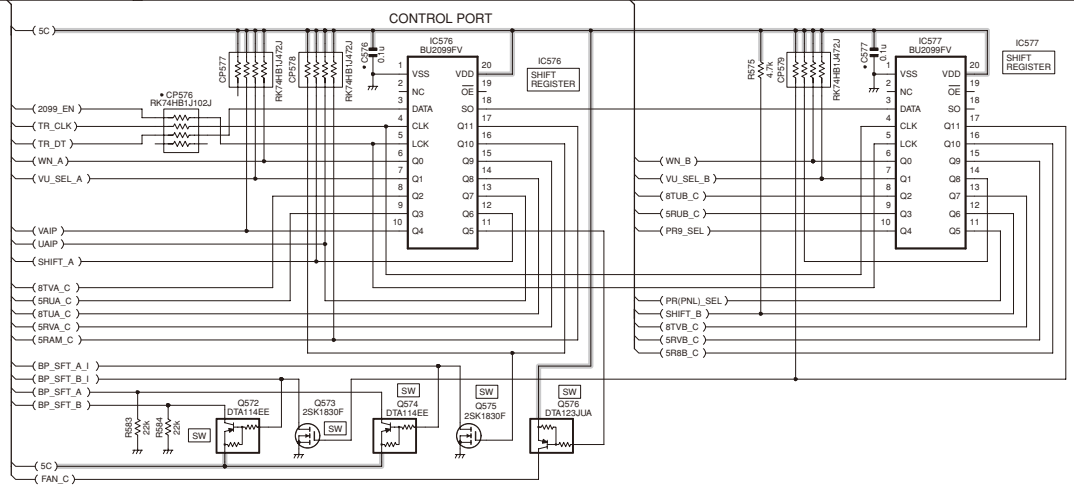
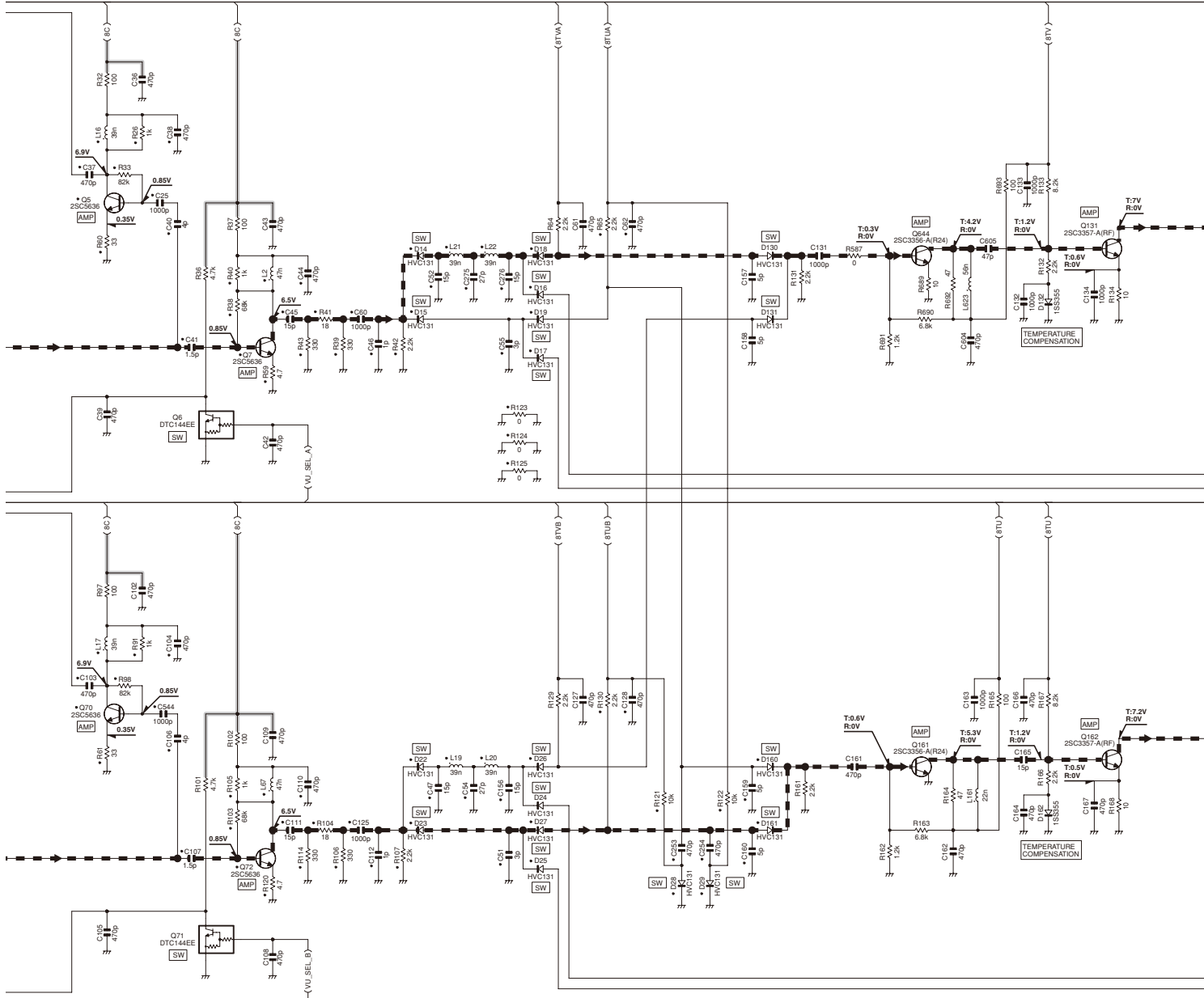

TM-D710A/D710E SCHEMATIC DIAGRAM

TX-RX UNIT (X57-731X-XX) (A/6): TX-RX SECTION

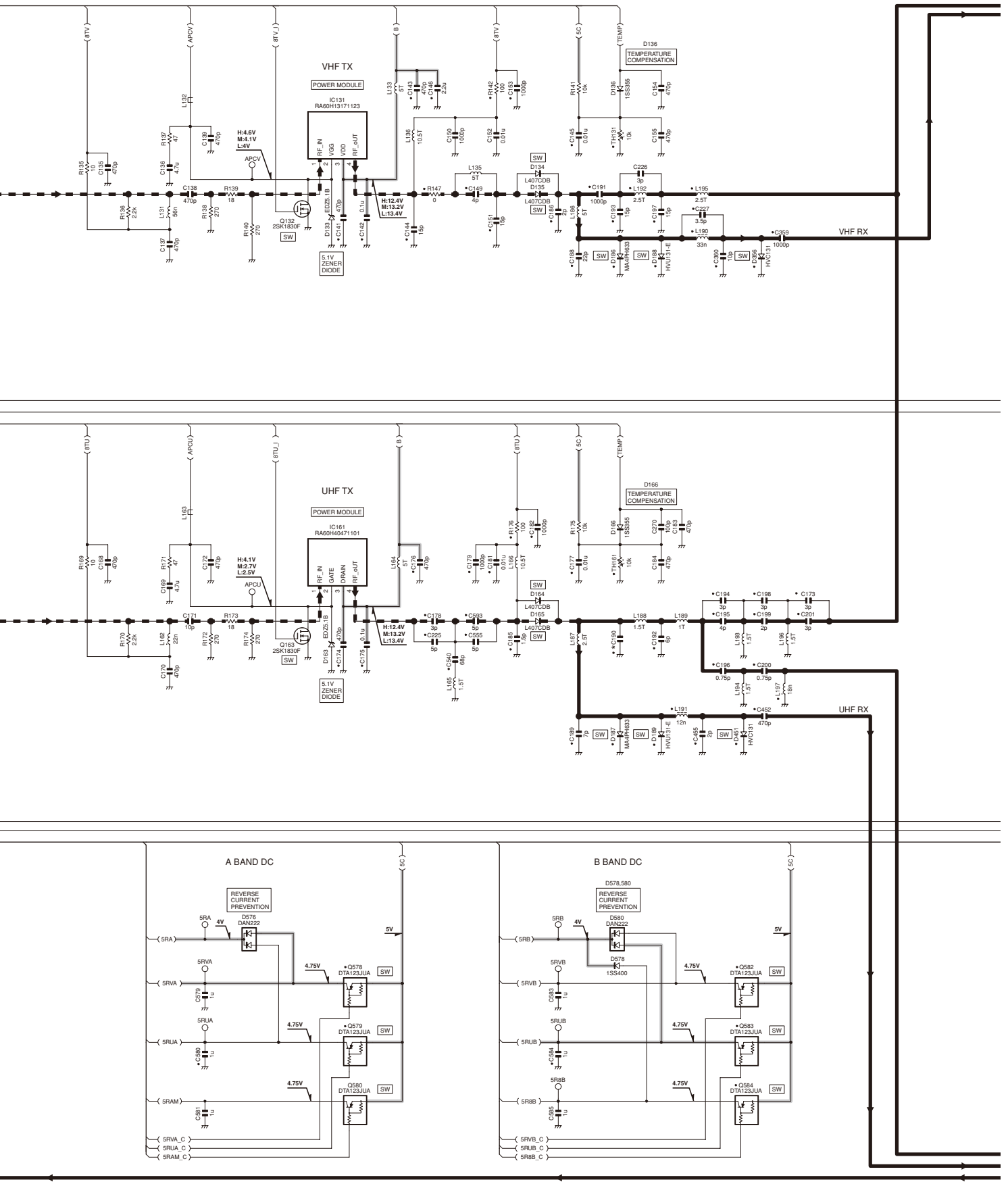

X57-731X-XX	C190
0-11	K 4p
2-71	E 5p
0-21	M4 4p

SCHEMATIC DIAGRAM TM-D710A/D710E

TX-RX UNIT (X57-731X-XX) (A/6): TX-RX SECTION

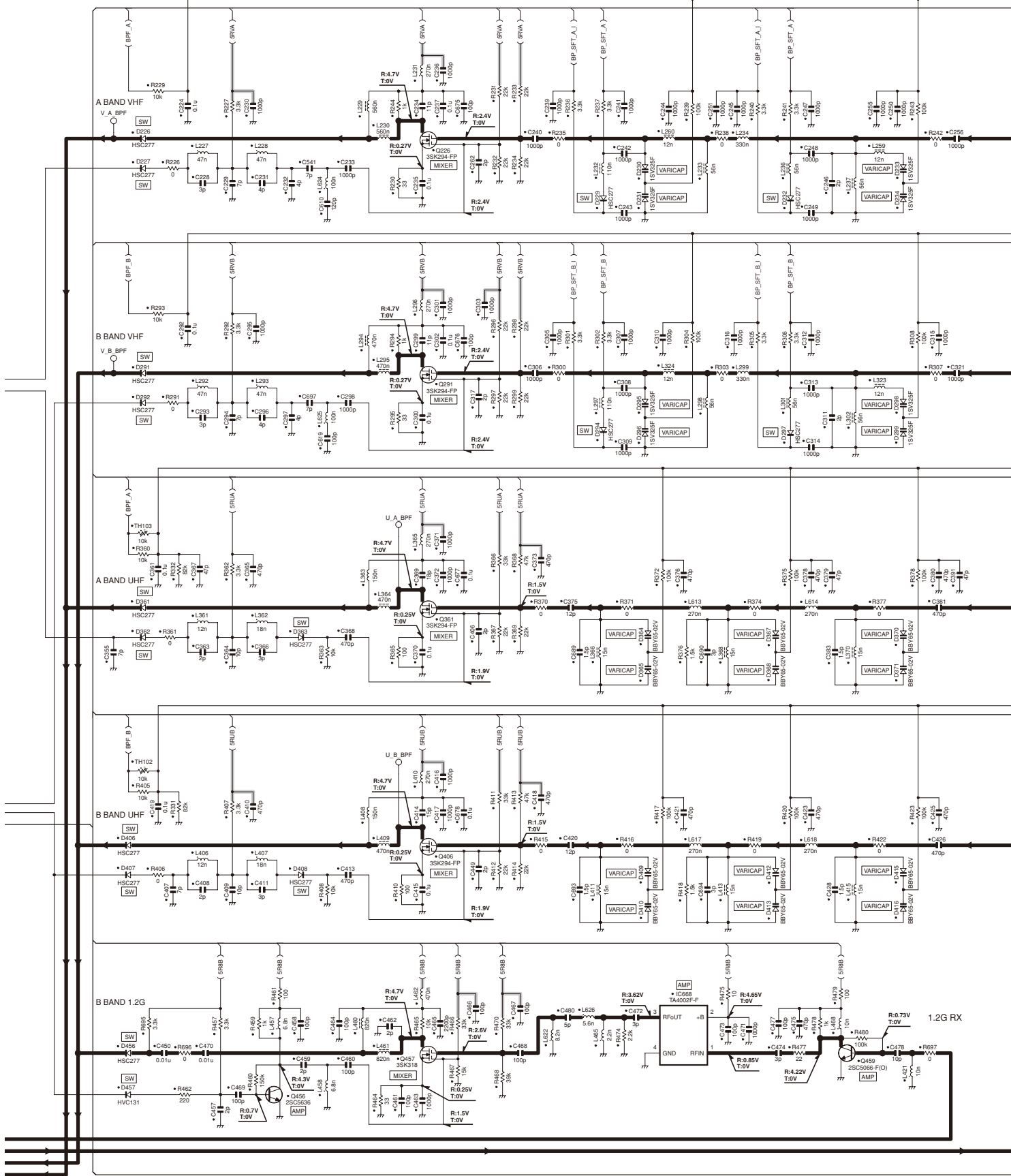

TM-D710A/D710E SCHEMATIC DIAGRAM

TX-RX UNIT (X57-731-XX) (A/6): TX-RX SECTION

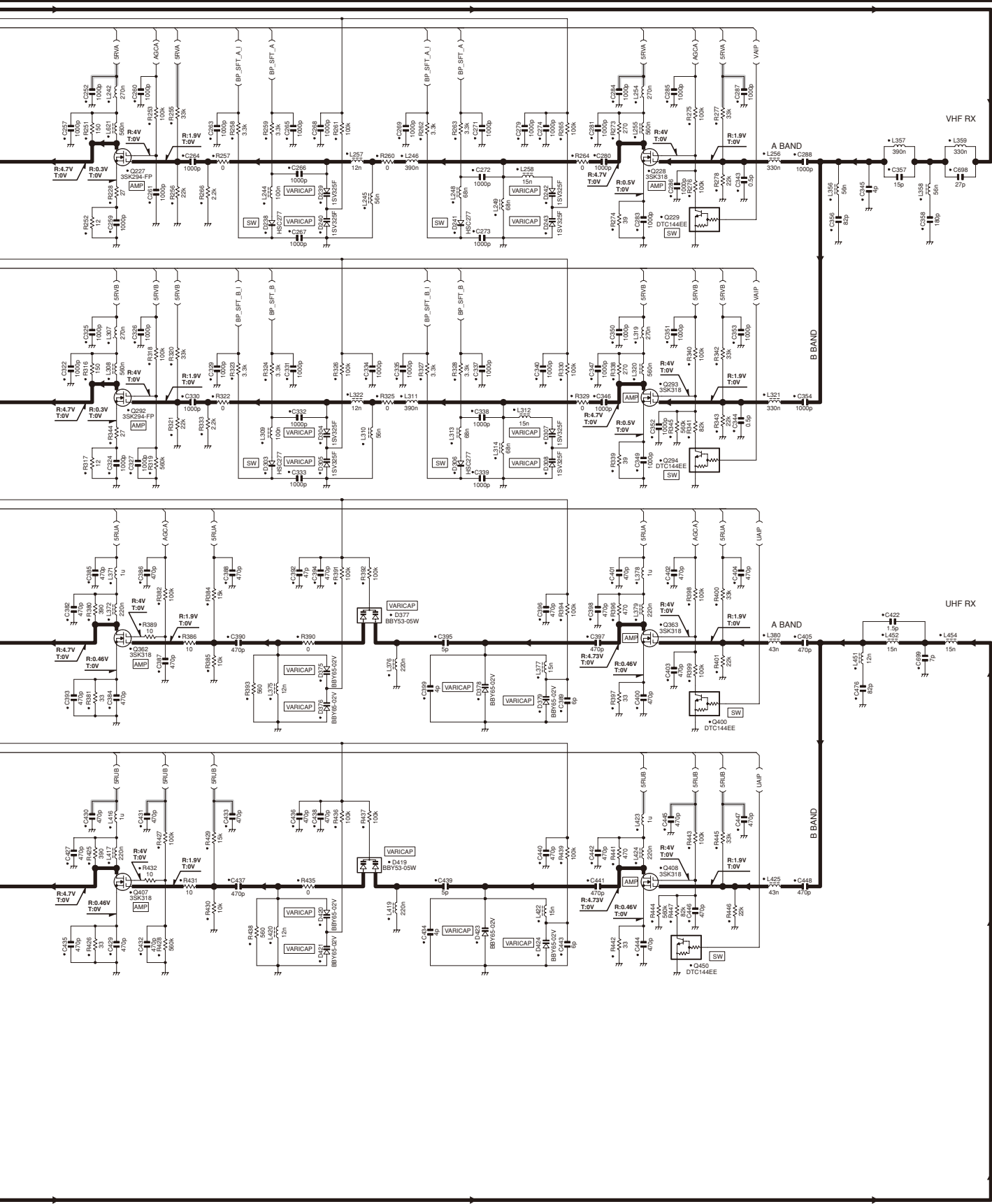

SCHEMATIC DIAGRAM TM-D710A/D710E

TX-RX UNIT (X57-731X-XX) (A/6): TX-RX SECTION

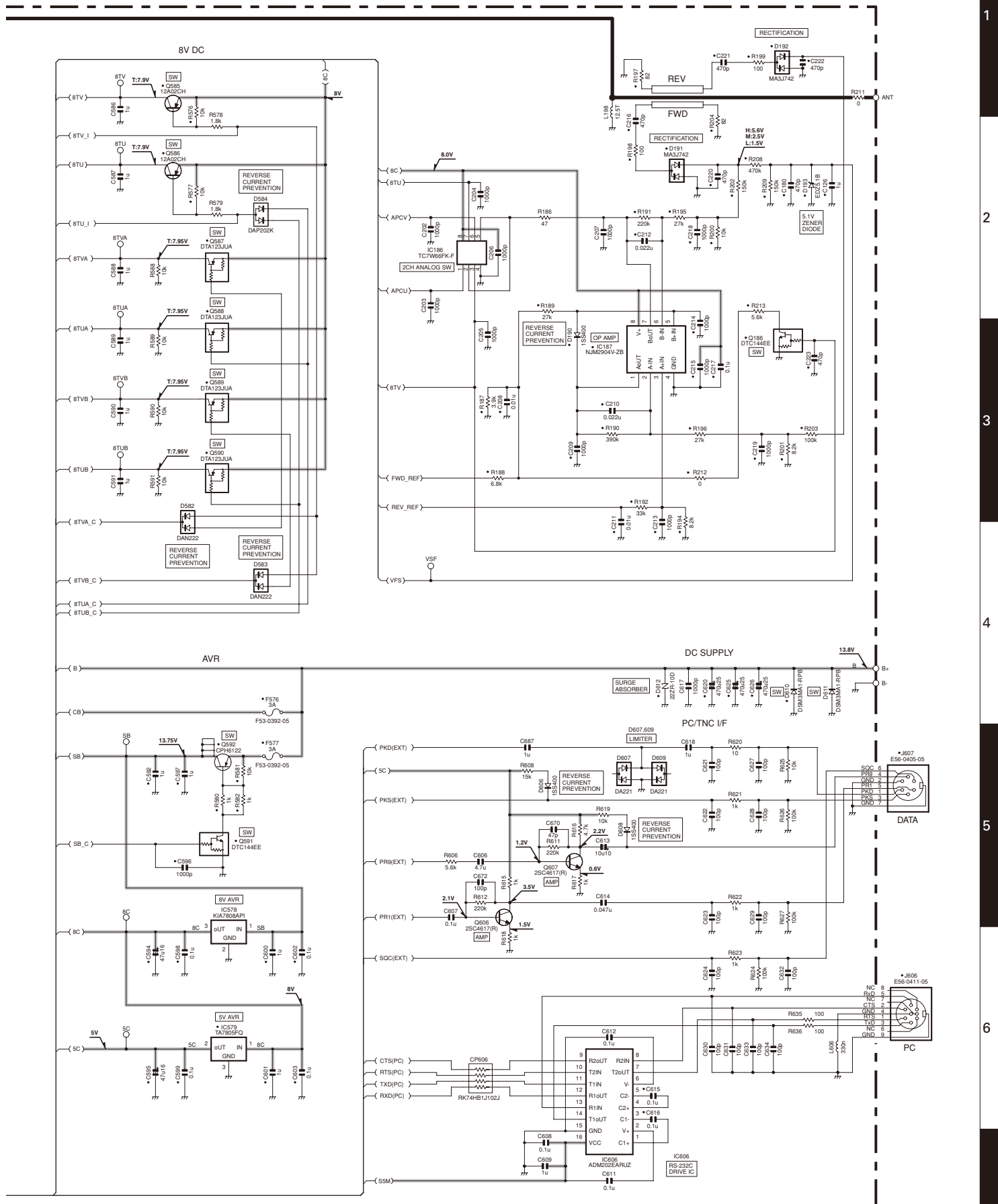

Note : The components marked with a dot (•) are parts of layer 1.

TM-D710A/D710E SCHEMATIC DIAGRAM

TX-RX UNIT (X57-731X-XX)(D/6) CONTROL SECTION

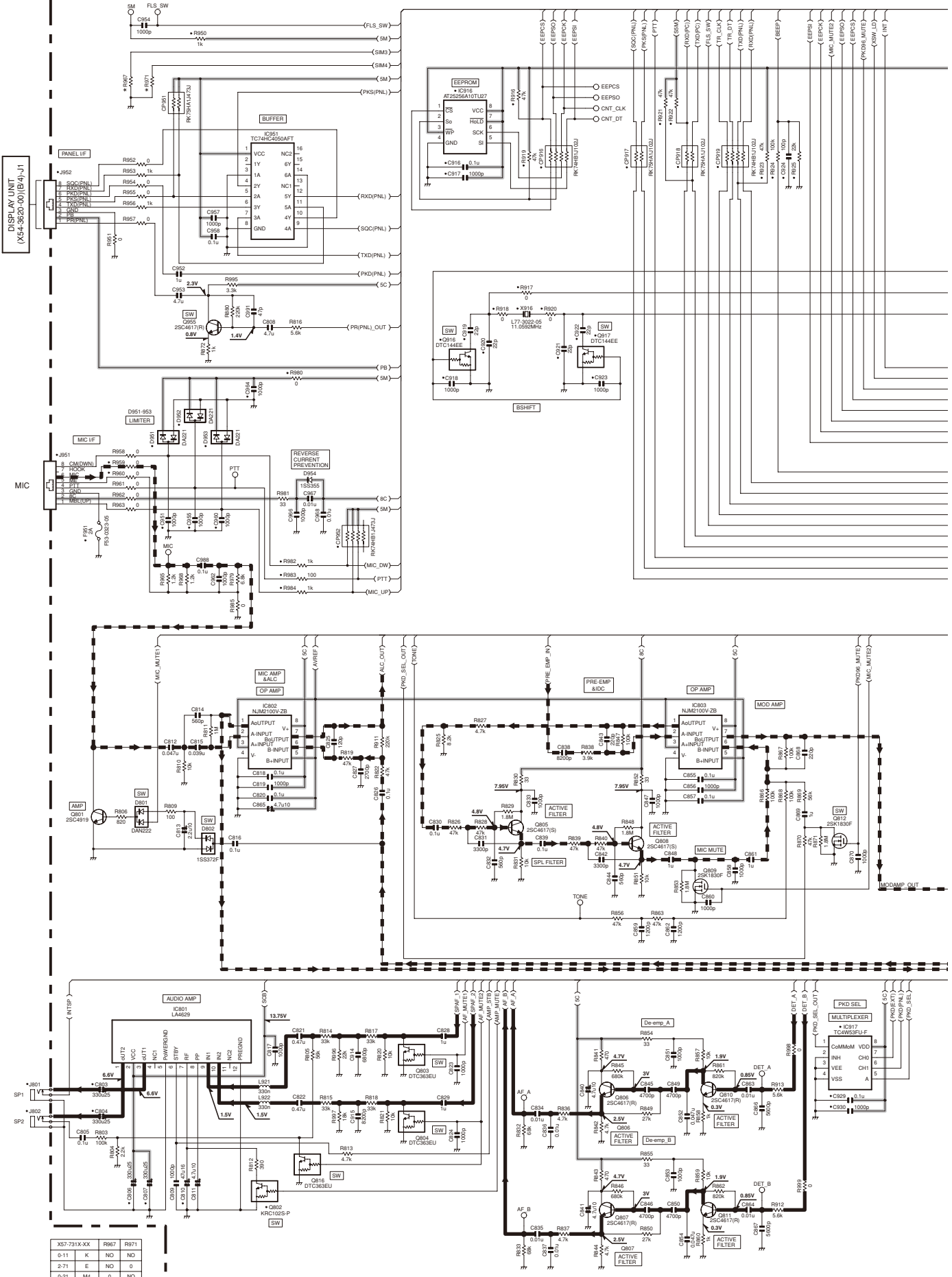

SCHEMATIC DIAGRAM TM-D710A/D710E

TX-RX UNIT (X57-731X-XX) (D/6): CONTROL SECTION

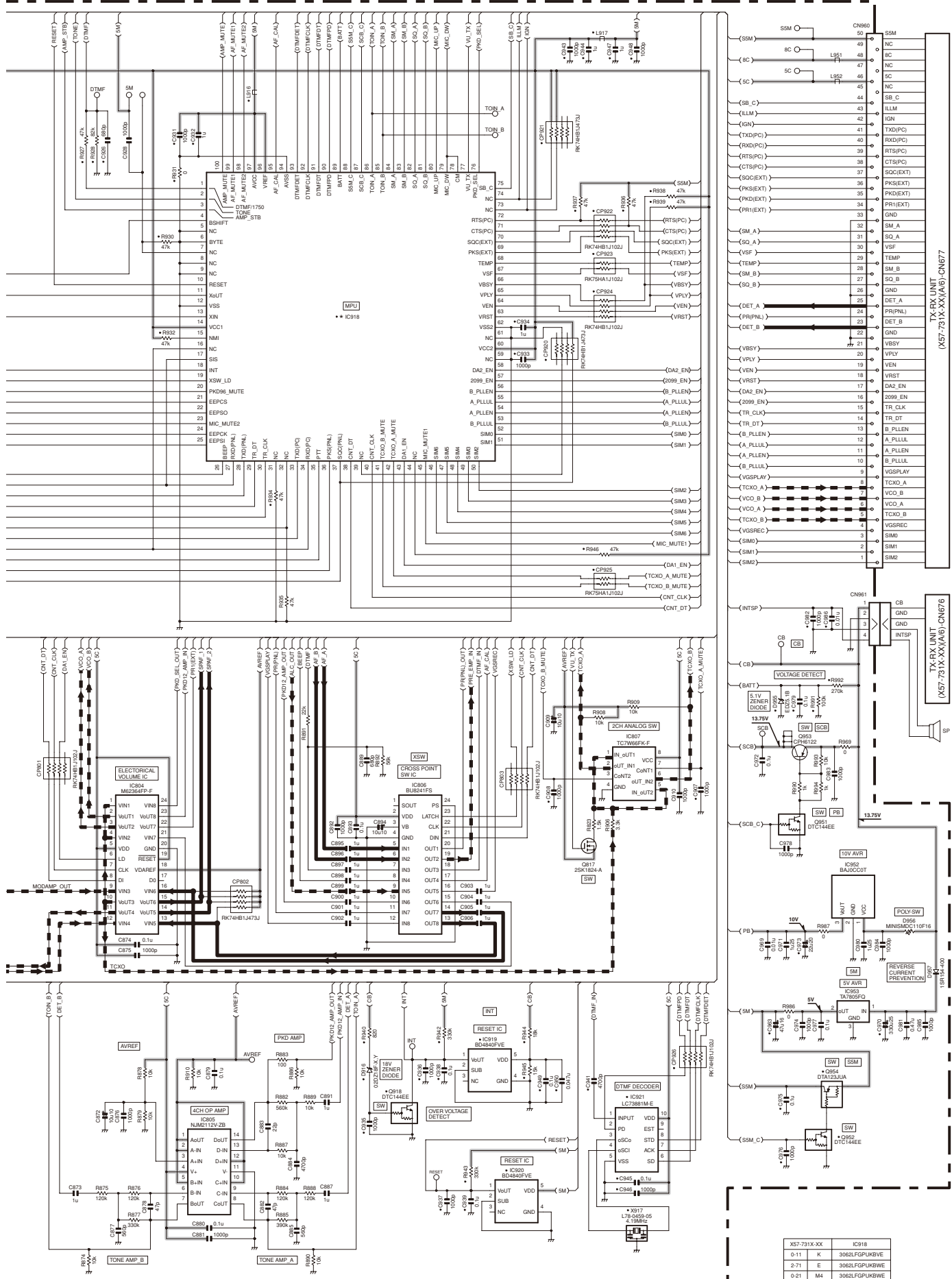

Note : The components marked with a dot (•) are parts of layer 1.

X57-731X-XX	IC318
0-11	K 3062LPGPUBKWE
2-71	E 3062LPGPUBKWE
0-21	M4 3062LPGPUBKWE

TM-D710A/D710E BLOCK DIAGRAM

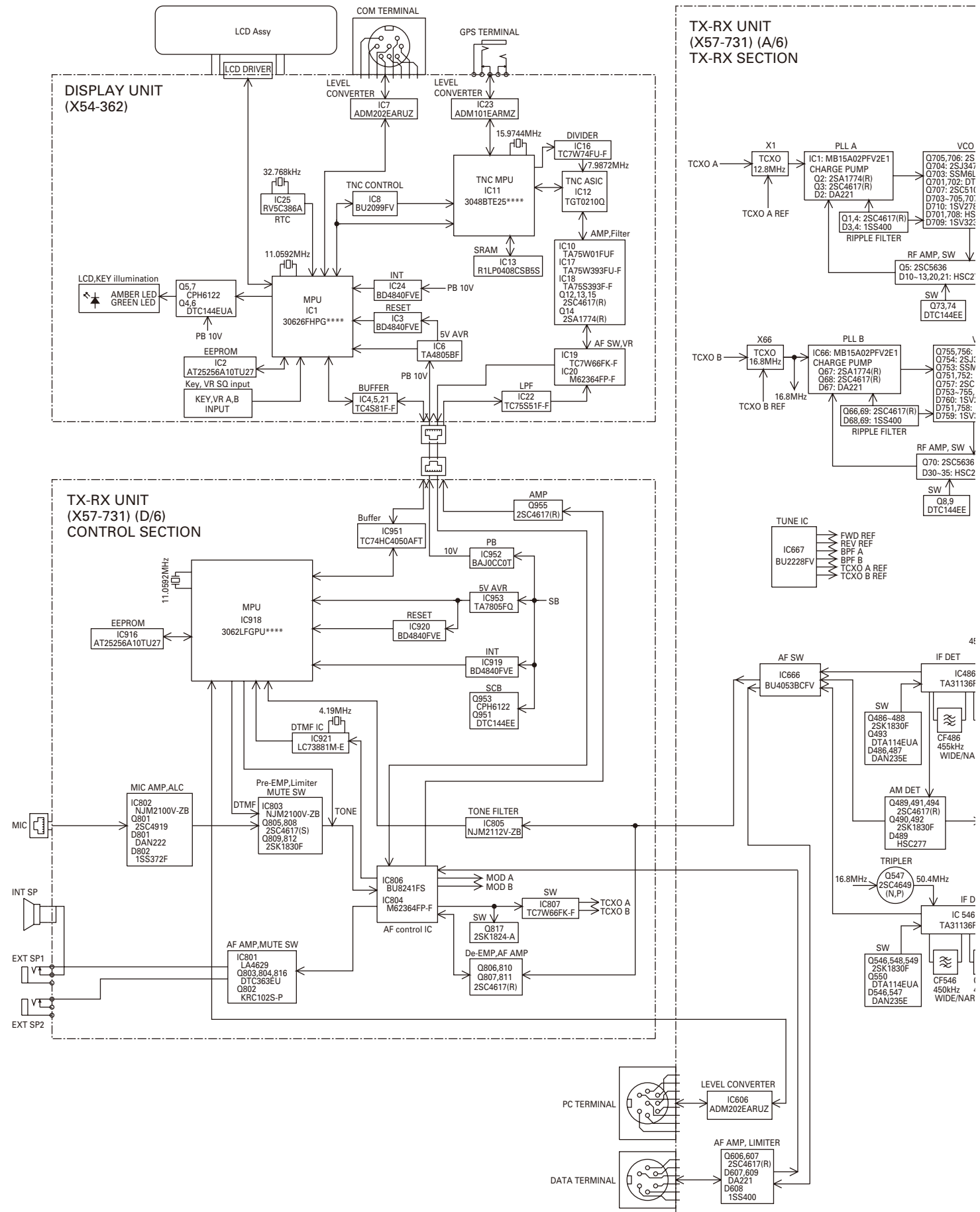

BLOCK DIAGRAM TM-D710A/D710E

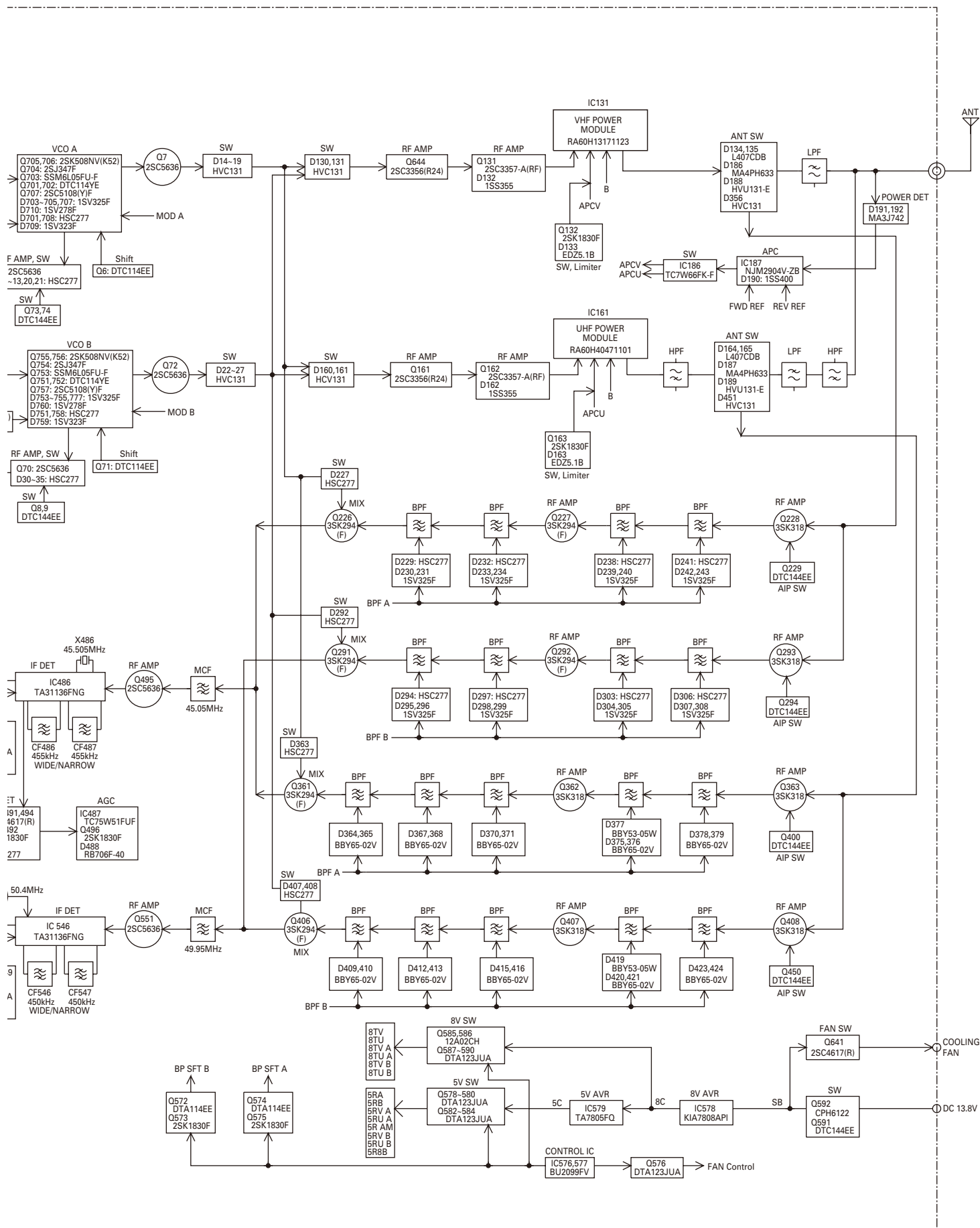

LEVEL DIAGRAM

Receiver Section

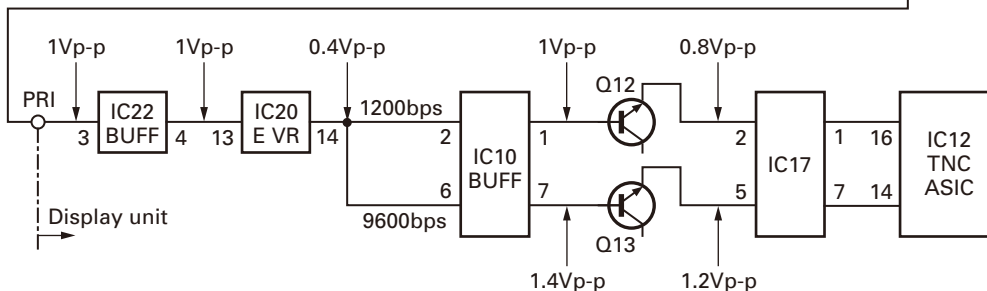
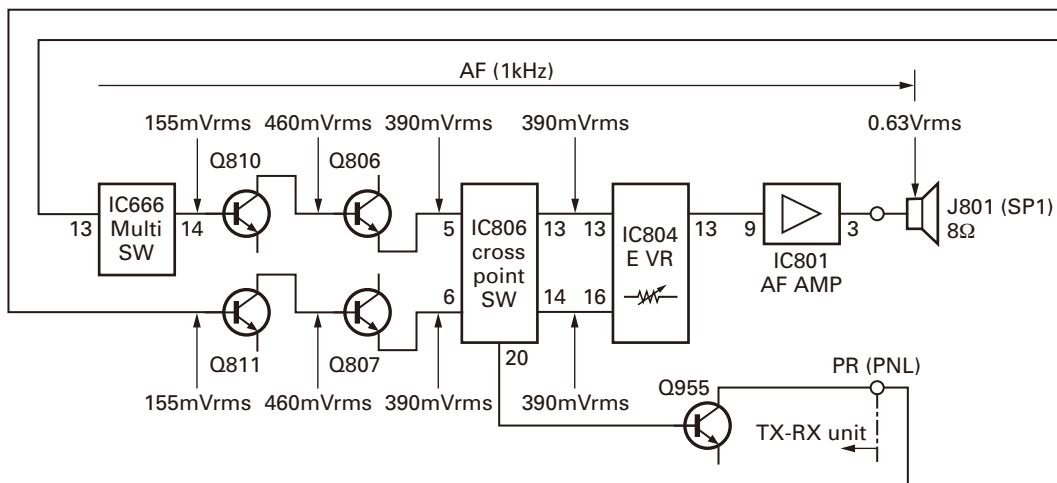
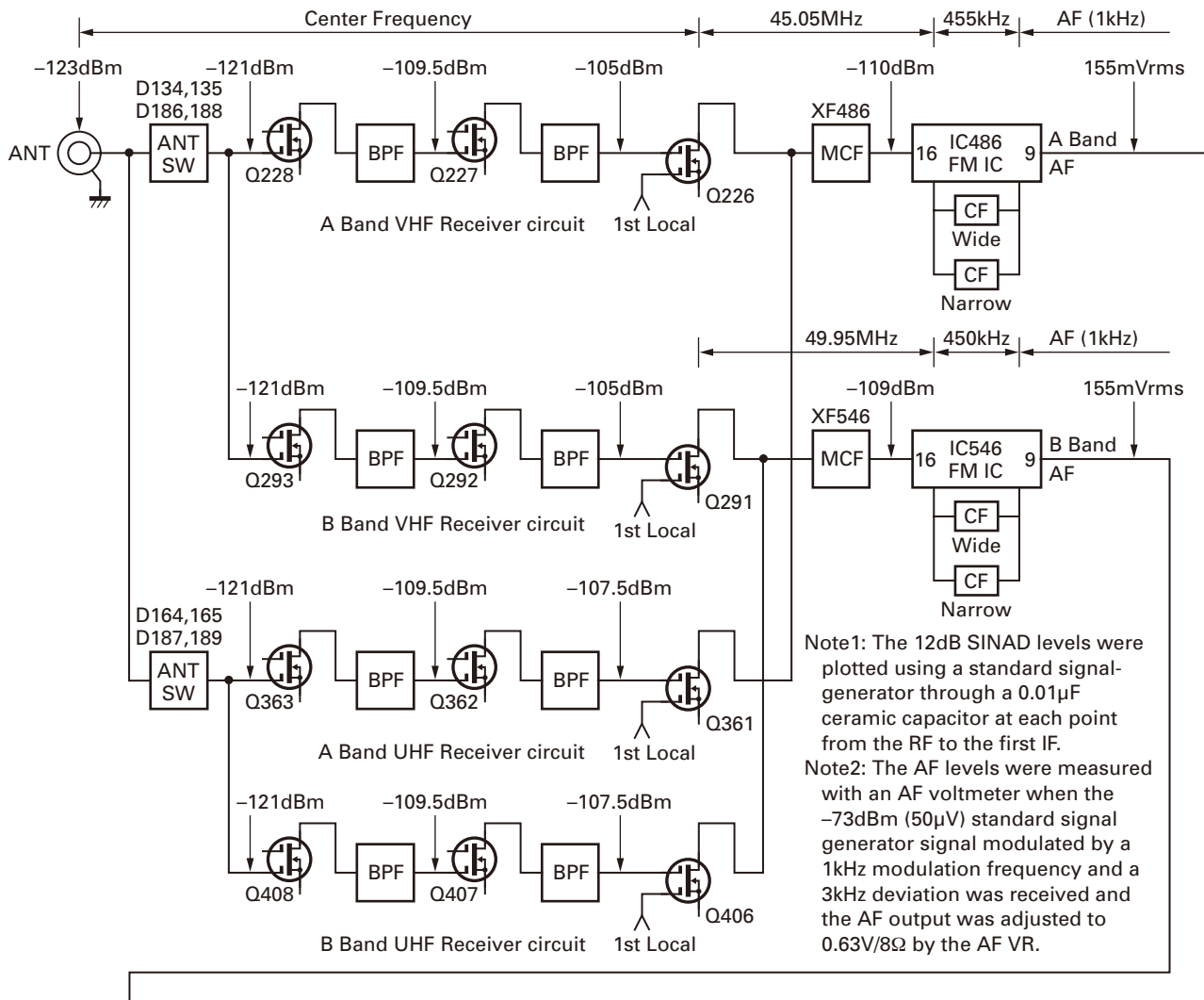

LEVEL DIAGRAM

Transmitter Section

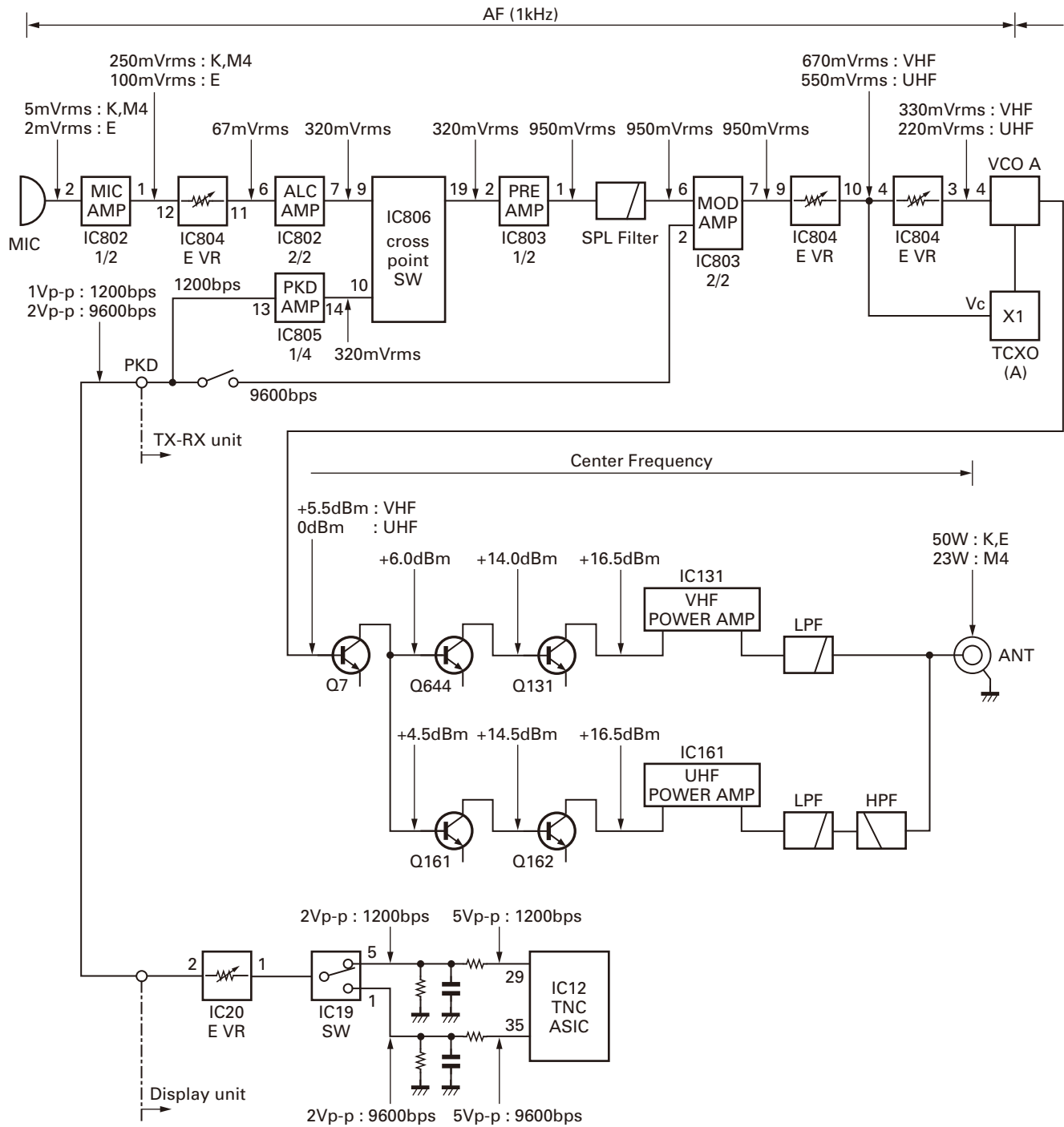

- Note 1: Set the AG so that the microphone socket input is 3kHz deviation at 1kHz modulation.
The data communication connector input level is 3kHz deviation at 1kHz modulation for 1200bps and 2kHz deviation at 1kHz modulation for 9600bps.
- Note 2: Set the transmit power to HI (K,E types) / MID (M4 type).
- Note 3: The measurements with the power meter, except for the ANT connector, are the values with the APC off.
- Note 4: When measuring the data level as 1200 or 9600 bps, perform the following settings in menu mode:
- BEACON TYPE: APRS (Menu mode: 600)
 - DATA SPEED: 1200 bps or 9600 bps (Menu mode: 601)

TM-D710A/D710E

OPTIONAL ACCESSORIES

MC-59 (Keypad Microphone)

■ External View



■ Cord Assembly

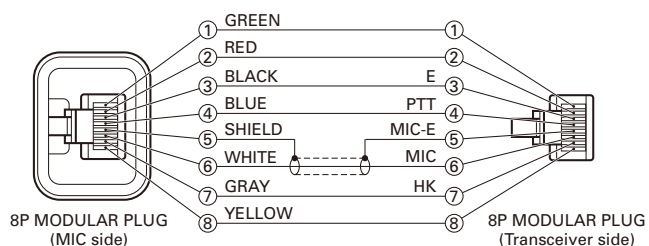

■ Specifications

Voltage Required8V±10%
 Operating Temperature Range
-20°C~+60°C (-4°F~+140°F)
 Current DrainLess than 12mA

* Refer to the MC-59 service manual (B51-8804-00) for servicing information, such as circuit diagram, parts list and etc.

PG-5G (Programming Interface Cable (2 m))

■ External View



■ PARTS LIST

Ref. No.	New parts	Parts No.	Q'ty	Description
①	*	E30-7607-05	1	PC cable (2m)

PG-5F (Extension Cable Kit (4 m))

■ External View

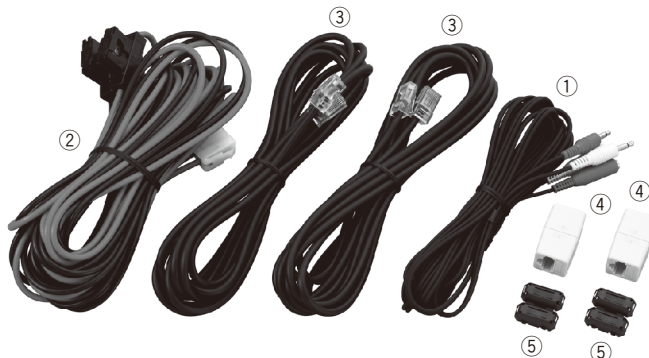

■ PARTS LIST

Ref. No.	New parts	Parts No.	Q'ty	Description
-	*	B62-2011-00	1	INSTRUCTION MANUAL
①		E30-3399-05	1	TRUNK CABLE (4m: SP)
②	*	E30-3462-05	1	DC CORD (6m)
③	*	E30-7639-05	2	MODULAR CABLE (4m: MIC/PANEL)
④	*	E58-0525-15	2	MODULAR JACK
-		G13-0978-04	1	CUSHION
-		J19-1433-05	2	HOLDER
⑤		L79-1417-05	2	LINE FILTER
-		N99-2016-15	1	SCREW SET

PG-5H (PC Interface Cable Kit (2 m))

■ External View

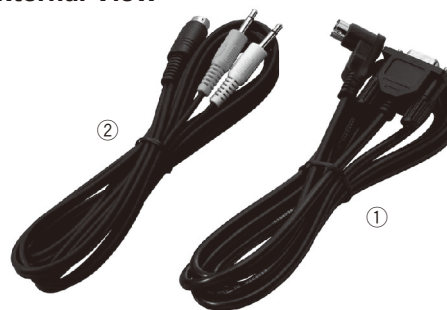

■ PARTS LIST

Ref. No.	New parts	Parts No.	Q'ty	Description
①	*	E30-7607-05	1	PC cable (2m)
②	*	E30-7608-05	1	Data cable (2m)

MCP-2A (Memory Control Program)

To download the MCP-2A software, go to:
http://www.kenwood.com/i/products/info/amateur/software_download.html

SPECIFICATIONS

General			TM-D710A	TM-D710E	TM-D710A
			K Type	E Type	M4 Type
Guaranteed range	Band A & B	TX & RX	144~148MHz	144~146MHz	
			438~450MHz	430~440MHz	
Frequency range	Band A	RX	118 ~ 524MHz		–
	Band B		136~524MHz		–
			800~1300MHz (K type: excluding cellular band)		–
Mode			F1D/ F2D/ F3E		
Antenna impedance			50 Ω		
Operating temperature range			–20°C~+60°C (–4°F~+140°F)		
Power requirement			13.8 V DC±15% (Negative ground)		
Frequency stability			Within ±5 ppm (–10°C~+50°C)		
Current	TX	VHF	HI	Less than 13.0A	–
			MID	Less than 5.5A	Less than 9.0A
			LOW	Less than 4.0A	
		UHF	HI	Less than 13.0A	–
			MID	Less than 6.5A	Less than 9.0A
			LOW	Less than 5.0A	
	RX		Less than 1.2A (at 2W audio output)		
Dimensions (W x H x D)	Without projections		Operation panel: 155 x 70 x 38 mm (6.20" x 2.80" x 1.52") TX/RX unit: 140 x 43 x 142 mm (5.60" x 1.72" x 5.68")		
	With projections		Operation panel: 156 x 71 x 56 mm (6.24" x 2.81" x 2.24") TX/RX unit: 140 x 44 x 158 mm (5.60" x 1.76" x 6.32")		
Weight (approx.)			Operation panel: 0.3 kg (0.66 lbs) TX/RX unit: 1.2 kg (2.64 lbs)		
Transmitter					
RF power output	HI		50W		–
	MID		Approx. 10W		25W
	LOW		Approx. 5W		
Modulation			Reactance modulation		
Maximum frequency deviation			Within ±5kHz		
Spurious radiation			Less than –60dB		
Modulation distortion (300Hz~3kHz)			Less than 3%		
Microphone impedance			600Ω		
Receiver					
Circuitry			Double super heterodyne		
Intermediate frequency	1st (Band A/ Band B)		45.05MHz/ 49.95MHz		
	2nd (Band A/ Band B)		455kHz/ 450kHz		
Sensitivity (144, 430/ 440MHz band)			Less than 0.16μV		
Squelch sensitivity (144, 430/ 440MHz band)			Less than 0.1μV		
Selectivity	–6dB		More than 11kHz		
	–50dB		Less than 30kHz		
Low frequency output (8Ω)			More than 2W (at 5% distortion)		

TM-D710A/D710E

SPECIFICATIONS

Sensitivity (approx.): excluding 144, 430/ 440MHz band

Frequency range	Band A		Band B
	FM: 12dB SINAD	AM: 10dB S/N	FM: 12dB SINAD
118~135.995MHz	0.32μV	0.40μV	-
136~173.995MHz	0.32μV	0.40μV	0.32μV
174~229.995MHz	0.40μV	0.50μV	0.40μV
230~299.995MHz	5.6μV	5.6μV	5.6μV
300~349.995MHz	1.0μV	1.0μV	1.0μV
350~399.995MHz	0.56μV	0.56μV	0.56μV
400~499.995MHz	0.28μV	0.36μV	0.28μV
500~523.995MHz	0.56μV	0.71μV	0.56μV
800~1239.99MHz	-	-	7.08μV
1240~1299.99MHz	-	-	2.24μV

Kenwood Corporation

2967-3, Ishikawa-machi, Hachioji-shi, Tokyo, 192-8525 Japan

Kenwood U.S.A. Corporation

P.O. BOX 22745, 2201 East Dominguez Street, Long Beach, CA 90801-5745, U.S.A.

Kenwood Electronics Canada Inc.

6070 Kestrel Road, Mississauga, Ontario, Canada L5T 1S8

Kenwood Electronics Deutschland GmbH

Rembrücker Str. 15, 63150 Heusenstamm, Germany

Kenwood Electronics Belgium N.V.

Leuvensesteenweg 248 J, 1800 Vilvoorde, Belgium

Kenwood Electronics France S.A.

L'Etoile Paris Nord 2, 50 Allée des Impressionnistes, Bp 58416 Villepinte, 95944 Roissy Ch De Gaulle Cedex

Kenwood Electronics UK Limited

KENWOOD House, Dwight Road, Watford, Herts., WD18 9EB United Kingdom

Kenwood Electronics Europe B.V.

Amsterdamseweg 37, 1422 AC Uithoorn, The Netherlands

Kenwood Electronics Italia S.p.A.

Via G. Sirtori, 7/9 20129 Milano, Italy

Kenwood Ibérica, S.A.

Bolivia, 239-08020 Barcelona, Spain

Kenwood Electronics Australia Pty. Ltd.

(A.C.N. 001 499 074)

16 Giffnock Avenue, Centrecourt Estate, North Ryde, N.S.W. 2113 Australia

Kenwood Electronics (Hong Kong) Ltd.

Unit 3712-3724, Level 37, Tower one Metroplaza, 223 Hing Fong Road, Kwai Fong, N.T., Hong Kong

Kenwood Electronics Singapore Pte Ltd

1 Ang Mo Kio Street 63, Singapore 569110



TM-D710A/D710E PC BOARD

DISPLAY UNIT (X54-3620-00) (A/4, B/4, C/4, D/4)
Component side view (J79-0141-09)

PC BOARD TM-D710A/D710E

DISPLAY UNIT (X54-3620-00) (A/4, B/4, C/4, D/4)
Component side view (J79-0141-09)

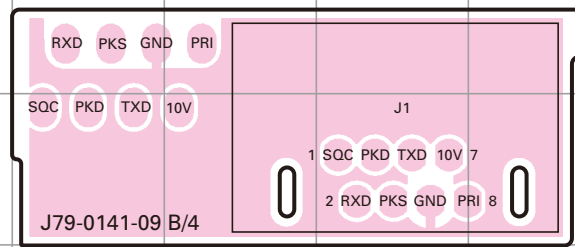
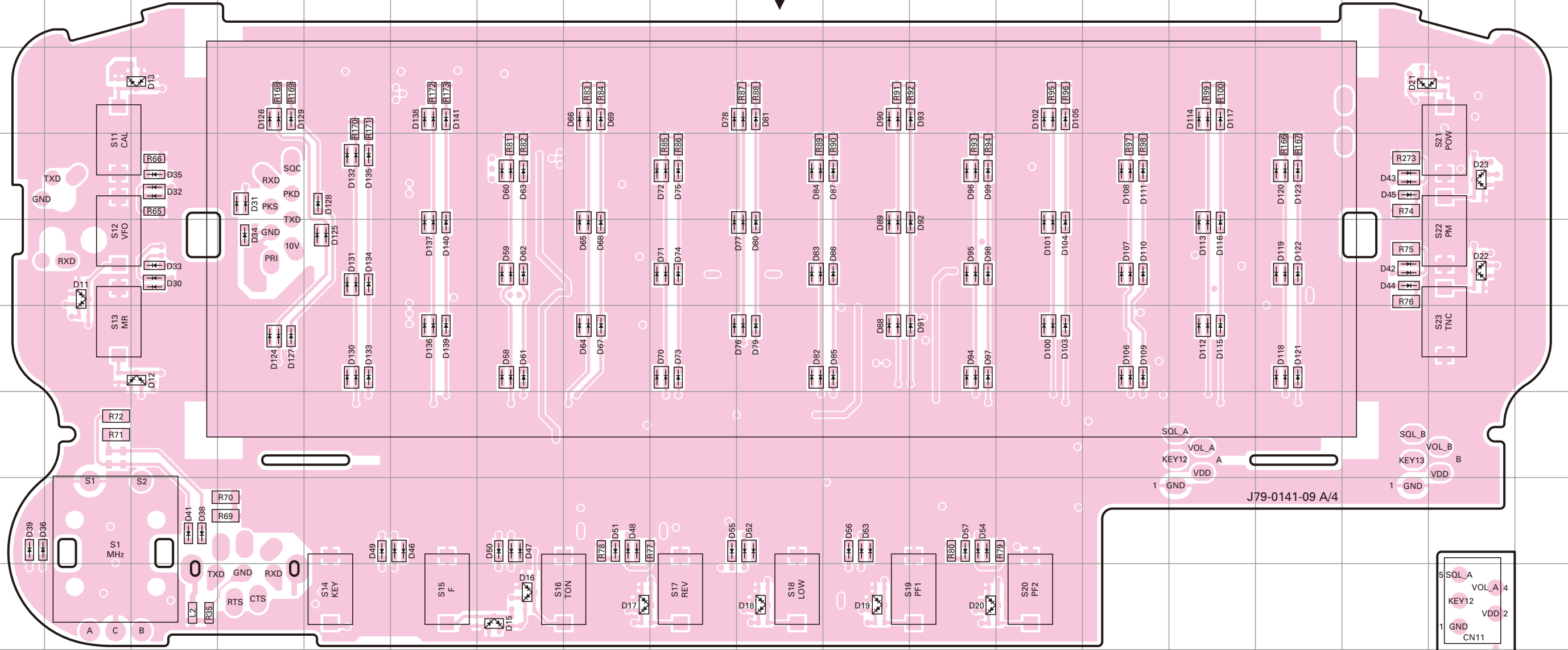

Ref. No.	Address	Ref. No.	Address	Ref. No.	Address	Ref. No.	Address	Ref. No.	Address	Ref. No.	Address	Ref. No.	Address		
D11	5B	D28	10R	D46	8F	D62	5G	D78	3J	D94	6L	D110	5N	D126	3D
D12	6C	D29	10R	D47	8G	D63	4G	D79	6J	D95	5L	D111	4N	D127	6D
D13	3C	D30	5C	D48	8H	D64	6H	D80	5J	D96	4L	D112	6O	D128	4E
D15	9G	D31	4D	D49	8E	D65	5H	D81	3J	D97	6L	D113	5O	D129	3D
D16	9G	D32	4C	D50	8G	D66	3H	D82	6J	D98	5L	D114	3O	D130	6E
D17	9H	D33	5C	D51	8H	D67	6H	D83	5J	D99	4L	D115	6O	D131	5E
D18	9J	D34	5D	D52	8H	D68	5H	D84	4J	D100	6M	D116	5O	D132	4E
D19	9K	D35	4C	D53	8K	D69	3H	D85	6K	D101	5M	D117	3O	D133	6E
D20	9L	D36	8A	D54	8L	D70	6I	D86	5K	D102	3M	D118	6P	D134	5E
D21	3Q	D38	8C	D55	8I	D71	5I	D87	4K	D103	6M	D119	5P	D135	4E
D22	5R	D39	8A	D56	8K	D72	4I	D88	6K	D104	5M	D120	4P	D136	6F
D23	4R	D41	8C	D57	8L	D73	6I	D89	5K	D105	3M	D121	6P	D137	5F
D24	13R	D42	5Q	D58	6G	D74	5I	D90	3K	D106	6N	D122	5P	D138	3F
D25	13R	D43	4Q	D59	5G	D75	4I	D91	6L	D107	5N	D123	4P	D139	6F
D26	13R	D44	5Q	D60	4G	D76	6J	D92	5L	D108	4N	D124	6D	D140	5F
D27	10R	D45	4Q	D61	6G	D77	5J	D93	3L	D109	6N	D125	5E	D141	3F

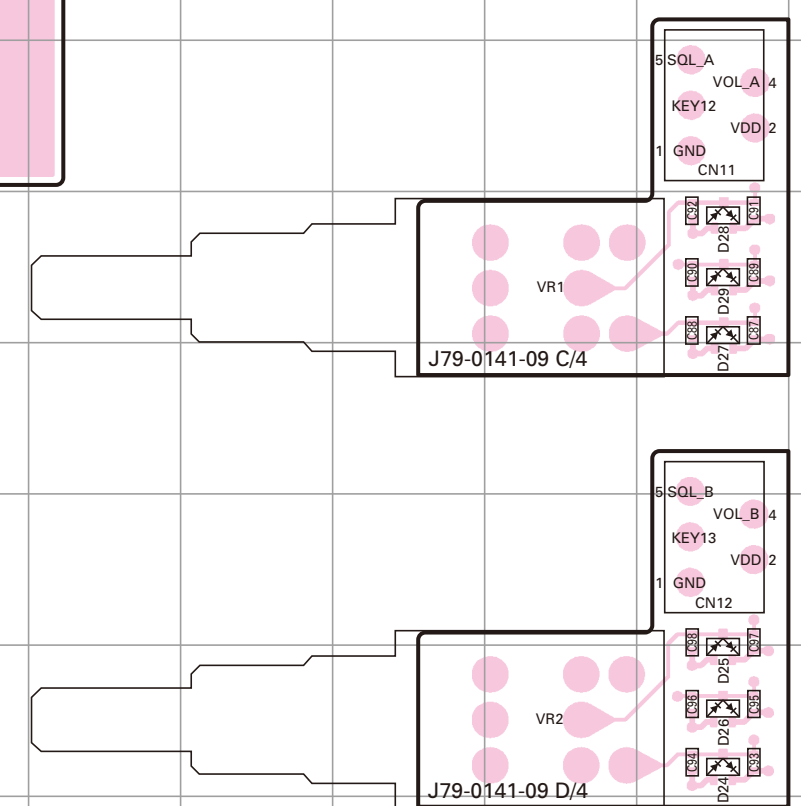
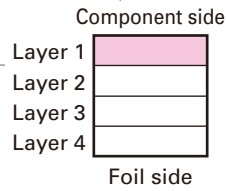

TM-D710A/D710E PC BOARD

DISPLAY UNIT (X54-3620-00) (A/4, B/4, C/4, D/4)
Foil side view (J79-0141-09)

PC BOARD TM-D710A/D710E

DISPLAY UNIT (X54-3620-00) (A/4, B/4, C/4, D/4)
Foil side view (J79-0141-09)

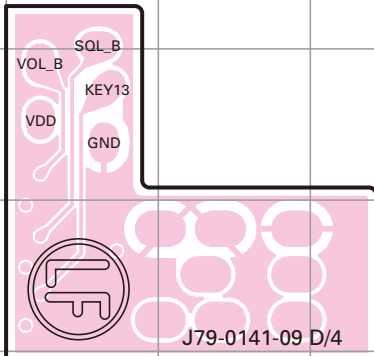
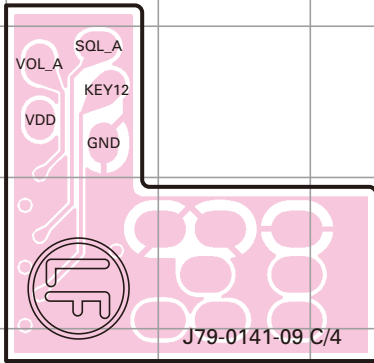
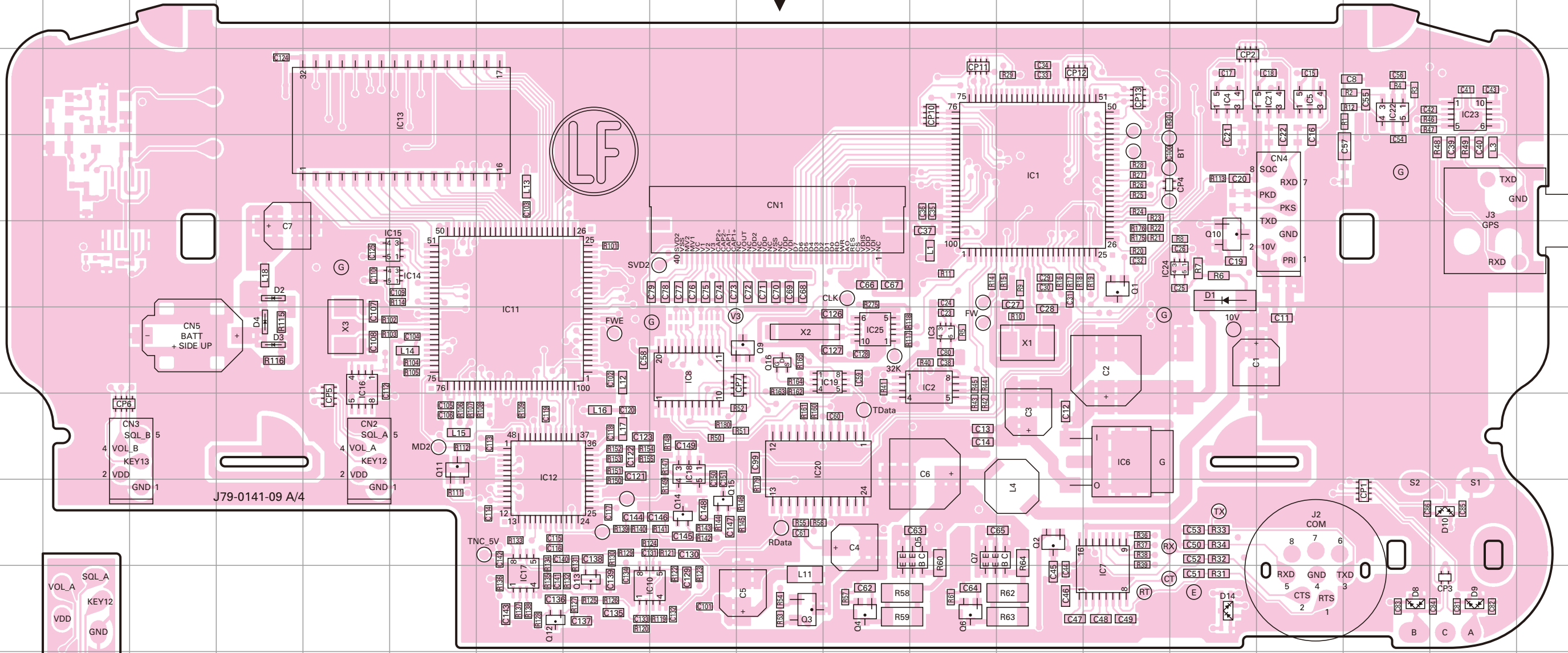

Ref. No.	Address	Ref. No.	Address	Ref. No.	Address	Ref. No.	Address
IC1	4M	IC16	6E	Q5	8L	D4	6D
IC2	6L	IC17	9G	Q6	9L	D8	9Q
IC3	6L	IC18	7I	Q7	8L	D9	9R
IC4	3O	IC19	6K	Q9	6J	D10	8R
IC5	3P	IC20	7J	Q10	5O	D14	9O
IC6	7N	IC21	3P	Q11	7F		
IC7	9N	IC22	3Q	Q12	9G		
IC8	6I	IC23	3R	Q13	9H		
IC10	9I	IC24	5O	Q14	8I		
IC11	6G	IC25	6K	Q15	8I		
IC12	7G	Q1	5N	Q16	6J		
IC13	3F	Q2	8M	D1	5O		
IC14	5F	Q3	9J	D2	5D		
IC15	5F	Q4	9K	D3	6D		

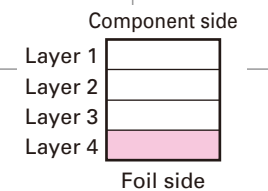
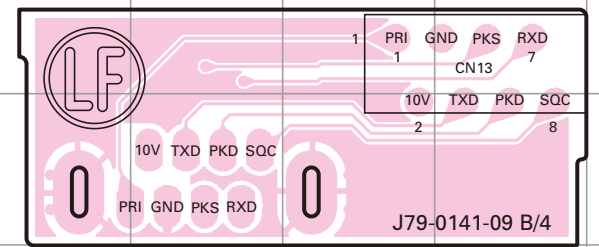

TM-D710A/D710E PC BOARD

**TX-RX UNIT
(X57-731X-XX)(A/6):
TX-RX SECTION
0-11:K 0-21:M4 2-71:E
Component side view
(J79-0142-19 A/6)**

Ref. No.	Address	Ref. No.	Address
IC1	13F	Q585	6F
IC66	8E	Q586	6F
IC187	10J	Q587	6E
IC579	6L	Q588	6E
IC578	6O	Q589	6E
IC668	7L	Q590	6E
Q2	13E	Q591	5N
Q4	12F	Q592	5M
Q5	11E	Q641	5O
Q7	11F	D2	13E
Q67	8F	D4	12G
Q70	10E	D5	13D
Q72	10E	D6	13D
Q186	10K	D10	11E
Q226	12H	D11	11E
Q227	13J	D12	12E
Q228	12L	D13	12E
Q229	11L	D14	11G
Q291	11H	D15	11G
Q292	12J	D16	12G
Q293	11L	D17	10G
Q294	11M	D18	12G
Q361	9H	D19	10G
Q362	9J	D20	12E
Q363	8L	D21	12E
Q400	8L	D22	10F
Q406	7H	D23	10G
Q407	8J	D25	9G
Q408	8L	D26	10F
Q450	7L	D27	10G
Q456	7J	D28	10G
Q457	7K	D29	9G
Q459	7M	D30	10E
Q489	4J	D31	10E
Q490	4K	D32	9E
Q491	4J	D33	9E
Q492	4K	D34	9E
Q493	5I	D35	9E
Q494	3J	D67	8F
Q550	5H	D70	8F
Q578	7E	D71	8F
Q579	7F	D160	10G
Q582	7E	D161	10G
Q583	7F	D186	13N
Q584	7F	D187	9M

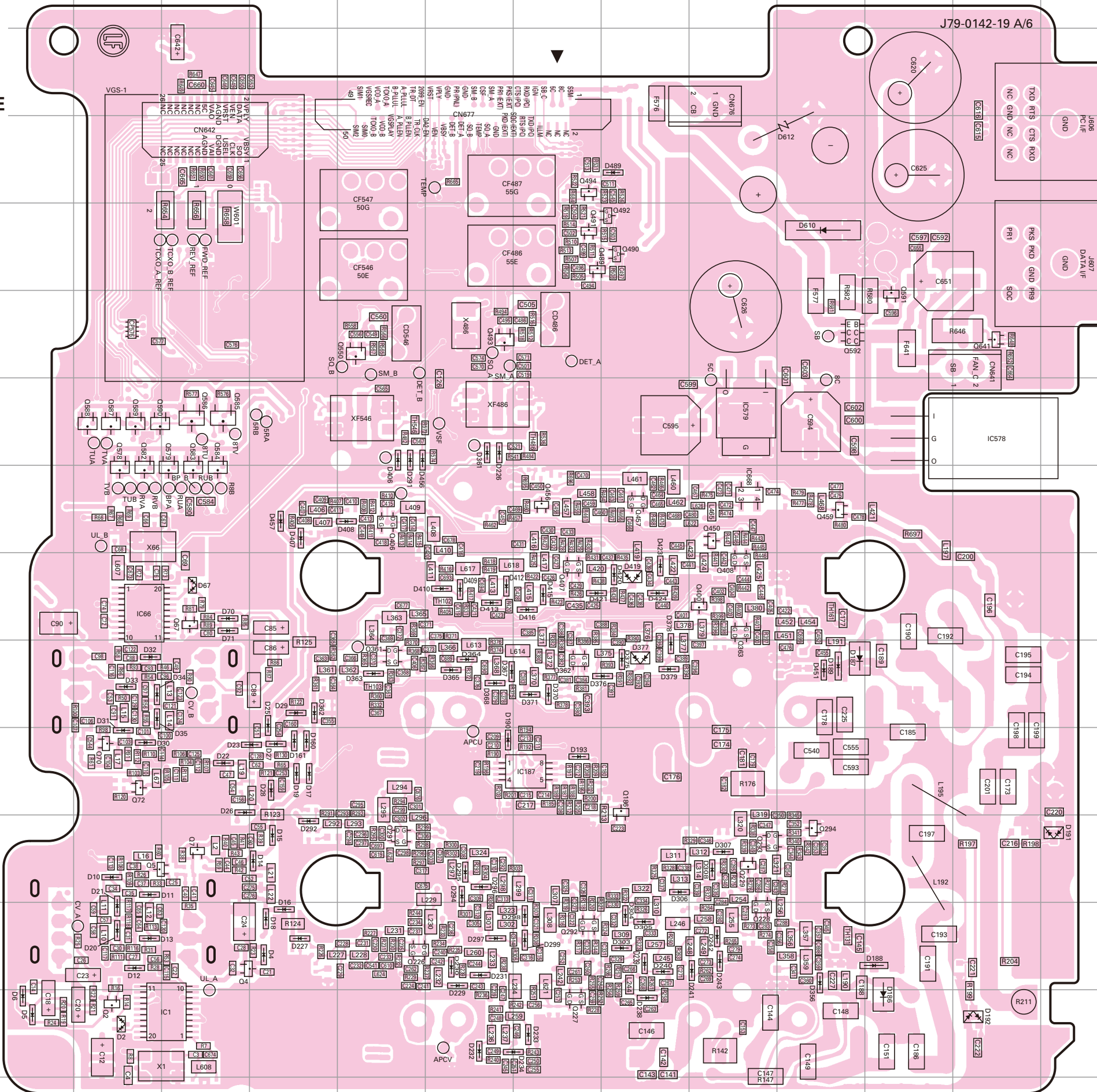

PC BOARD TM-D710A/D710E

**TX-RX UNIT
(X57-731X-XX)(A/6):
TX-RX SECTION
0-11:K 0-21:M4 2-71:E
Component side view
(J79-0142-19 A/6)**

Ref. No.	Address	Ref. No.	Address
D188	12N	D361	6I
D189	9M	D362	9G
D190	10I	D363	9H
D191	11P	D364	9I
D192	13O	D365	9I
D193	10J	D367	9I
D226	6I	D368	9I
D227	12G	D370	9J
D229	12I	D371	9J
D230	12I	D375	9K
D231	12I	D376	9K
D232	13I	D377	9K
D233	13J	D378	9K
D234	13J	D379	9K
D238	13K	D406	6H
D239	12K	D407	7G
D240	12K	D408	7H
D241	12L	D409	8I
D242	12L	D410	8I
D243	12L	D412	8I
D291	6H	D413	8I
D292	11G	D415	8J
D294	11I	D416	8J
D295	11I	D419	8K
D296	11I	D420	8K
D297	12I	D421	8J
D298	12J	D423	8K
D299	12J	D424	8K
D303	12K	D451	9M
D304	12K	D456	6H
D305	12K	D457	7G
D306	11K	D489	3K
D307	11L	D610	4M
D308	11L	D612	3M
D356	12M		

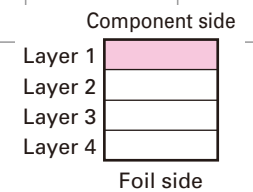

TM-D710A/D710E PC BOARD

PC BOARD TM-D710A/D710E

**TX-RX UNIT
(X57-731X-XX)(A/6):
TX-RX SECTION
0-11 : K 0-21 : M4 2-71 : E
Foil side view
(J79-0142-19 A/6)**

**TX-RX UNIT
(X57-731X-XX)(A/6):
TX-RX SECTION
0-11 : K 0-21 : M4 2-71 : E
Foil side view
(J79-0142-19 A/6)**

Ref. No.	Address	Ref. No.	Address
IC131	11I	Q576	4N
IC161	8I	Q580	4I
IC186	10J	Q606	4E
IC486	5J	Q607	4F
IC487	4I	Q642	4G
IC546	5L	Q644	13M
IC576	5O	D1	13N
IC577	5N	D3	13P
IC606	3E	D24	11M
IC666	3M	D66	8O
IC667	3N	D68	8N
Q1	13P	D69	9O
Q3	13O	D130	13M
Q6	12O	D131	13M
Q8	9N	D132	13M
Q9	9O	D133	13K
Q66	8N	D134	13F
Q68	8N	D135	13F
Q69	9O	D136	12F
Q71	9N	D162	10L
Q73	12O	D163	10K
Q74	12O	D164	9F
Q131	13L	D165	9F
Q132	13K	D166	9G
Q161	10L	D486	4K
Q162	10L	D487	4J
Q163	10K	D488	3J
Q486	4J	D546	4M
Q487	4J	D547	4K
Q488	5J	D576	7N
Q495	5K	D578	7N
Q496	3I	D580	7N
Q546	4L	D582	6O
Q547	5M	D583	6O
Q548	4L	D584	6N
Q549	6L	D606	4E
Q551	6L	D607	4E
Q572	5M	D608	5F
Q573	5N	D609	4E
Q574	5N	D611	3H
Q575	5N		

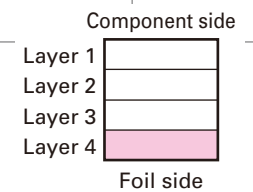
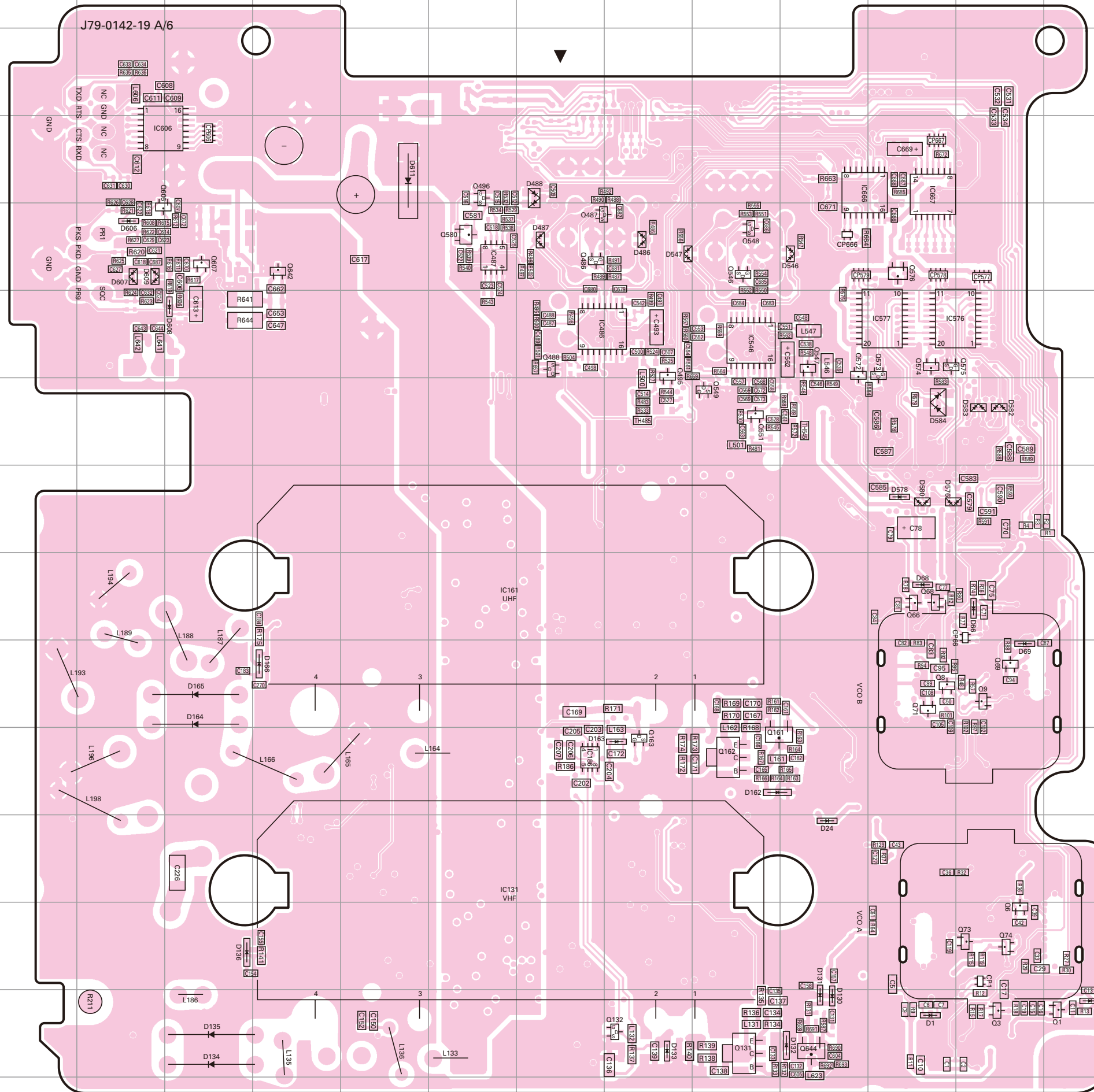

TM-D710A/D710E PC BOARD

TX-RX UNIT (X57-731X-XX) (D/6) : CONTROL SECTION
0-11 : K 0-21 : M4 2-71 : E Component side view (J79-0142-19 D/6)

PC BOARD TM-D710A/D710E

TX-RX UNIT (X57-731X-XX) (D/6) : CONTROL SECTION
0-11 : K 0-21 : M4 2-71 : E Component side view (J79-0142-19 D/6)

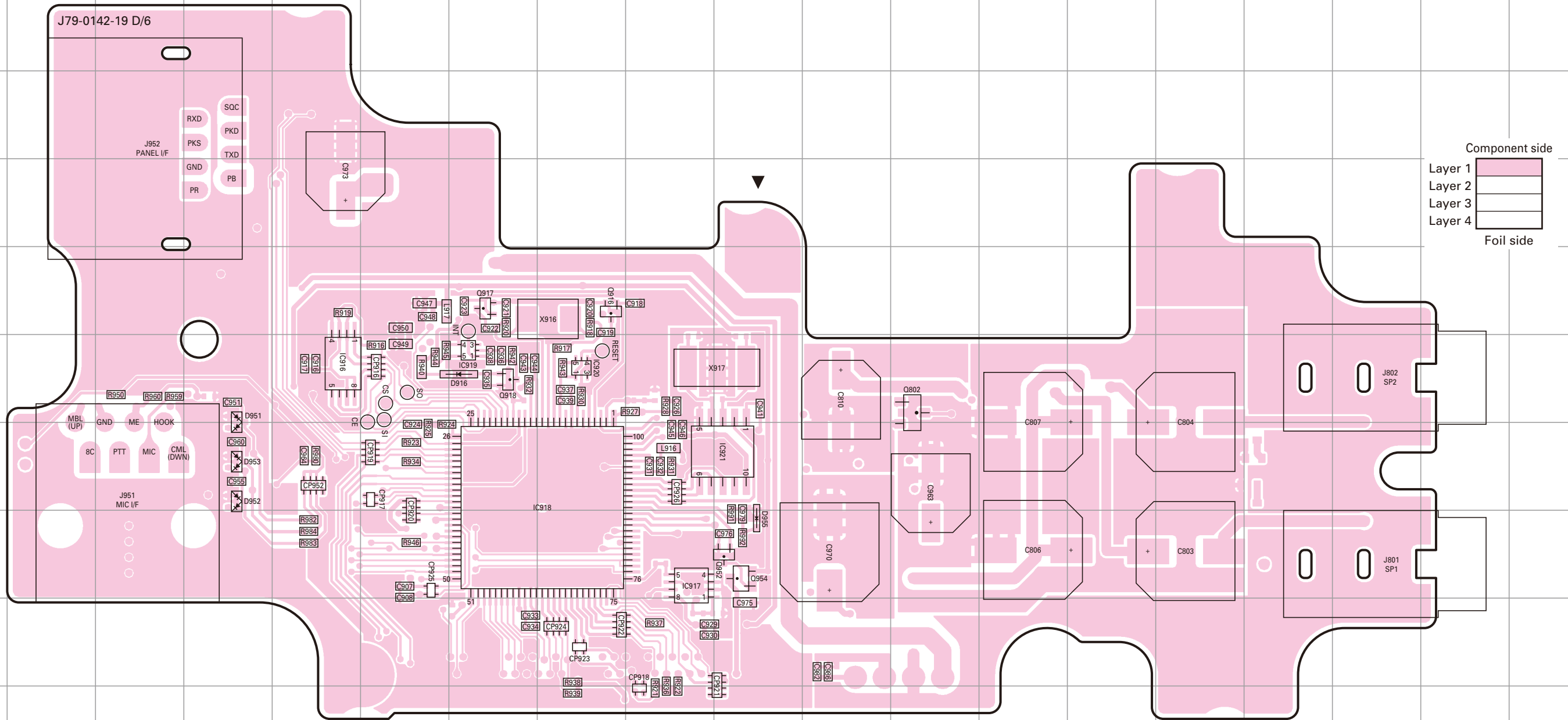

**TX-RX UNIT (E/6) :
VCO A SECTION**

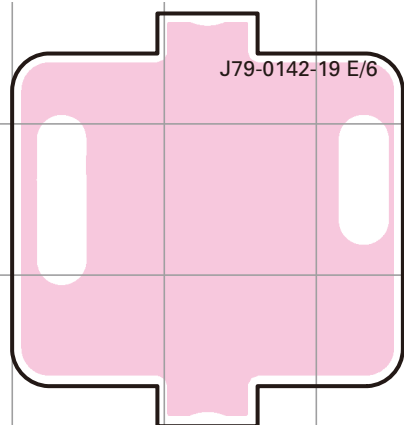

**TX-RX UNIT (B/6) :
VCO A SECTION**

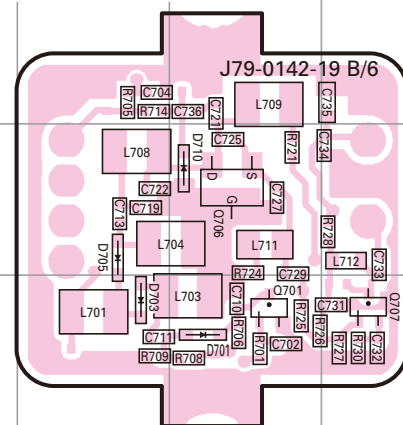

**TX-RX UNIT (C/6) :
VCO B SECTION**

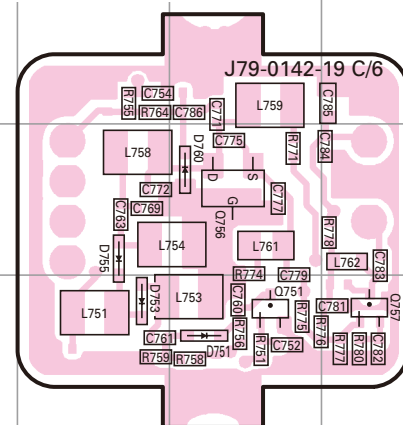

**TX-RX UNIT (F/6) :
VCO B SECTION**

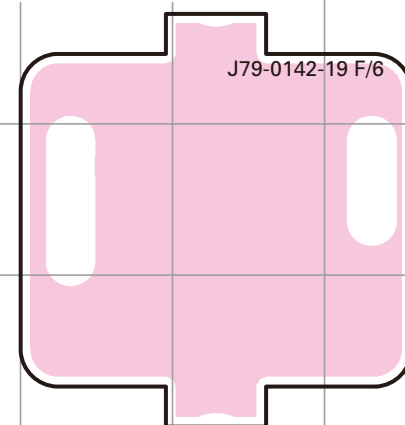

Ref. No.	Address	Ref. No.	Address	Ref. No.	Address
IC916	6E	Q757	13J	D751	13I
IC917	8I	Q802	6L	D753	13H
IC918	7H	Q916	5H	D755	12H
IC919	6G	Q917	5G	D760	12I
IC920	6H	Q918	6G	D916	6G
IC921	7J	Q952	8J	D951	6D
Q701	13F	Q954	8J	D952	7D
Q706	12F	D701	13F	D953	7D
Q707	13G	D703	13E	D955	8J
Q751	13I	D705	12E		
Q756	12I	D710	12F		

TM-D710A/D710E PC BOARD

TX-RX UNIT (X57-731X-XX) (D/6) : CONTROL SECTION
0-11 : K 0-21 : M4 2-71 : E Foil side view (J79-0142-19 D/6)

PC BOARD TM-D710A/D710E

TX-RX UNIT (X57-731X-XX) (D/6) : CONTROL SECTION
0-11 : K 0-21 : M4 2-71 : E Foil side view (J79-0142-19 D/6)

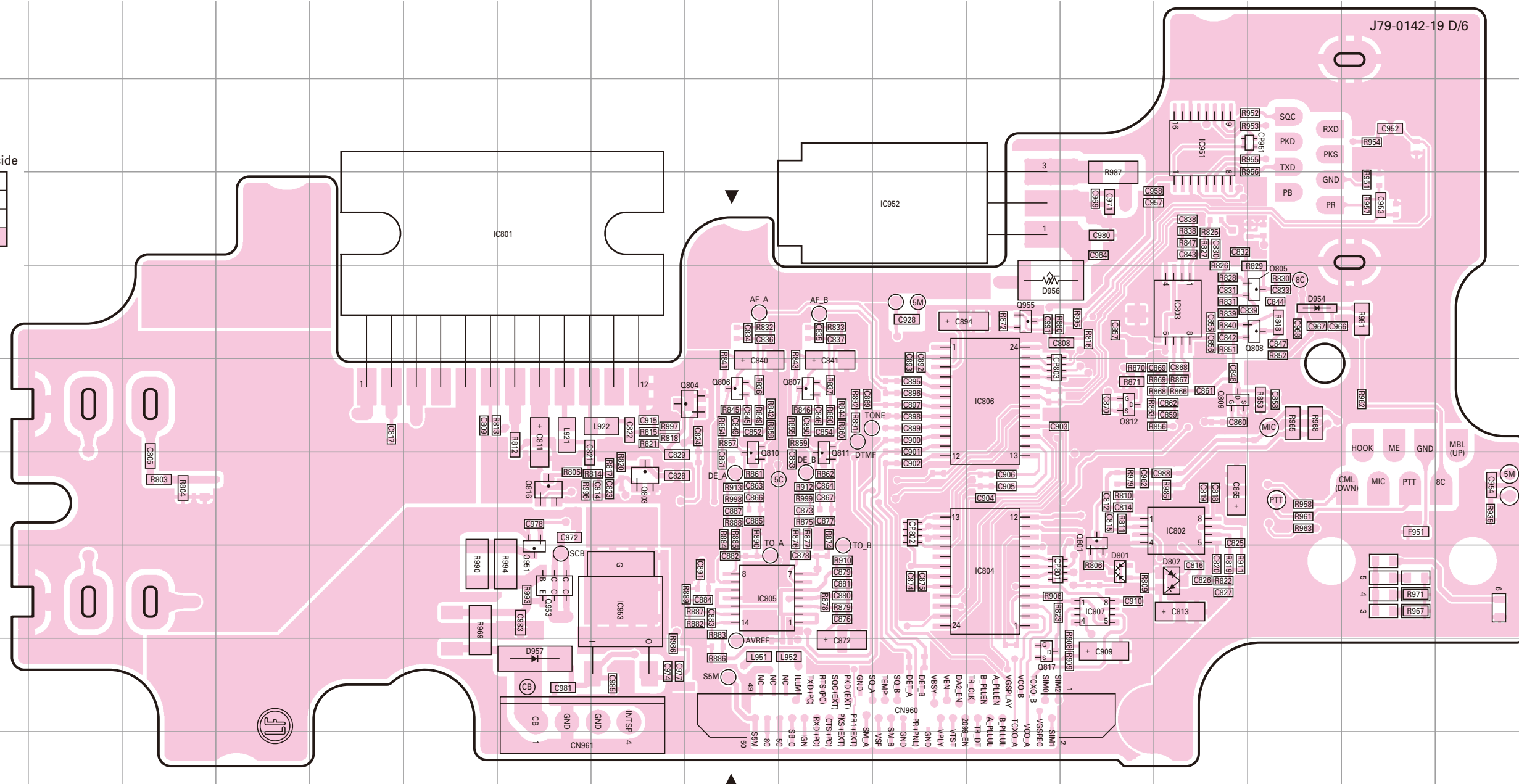
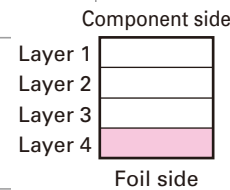

TX-RX UNIT (F/6) :
VCO B SECTION

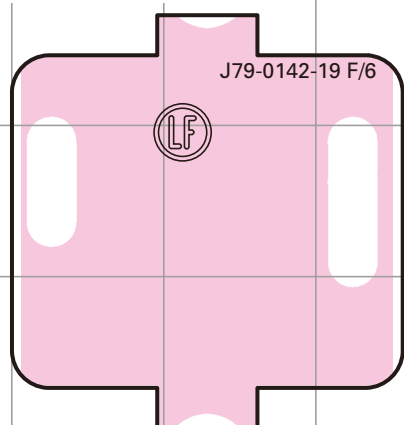

TX-RX UNIT (C/6) :
VCO B SECTION

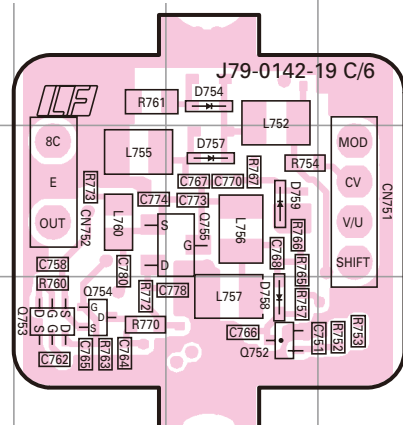

TX-RX UNIT (B/6) :
VCO A SECTION

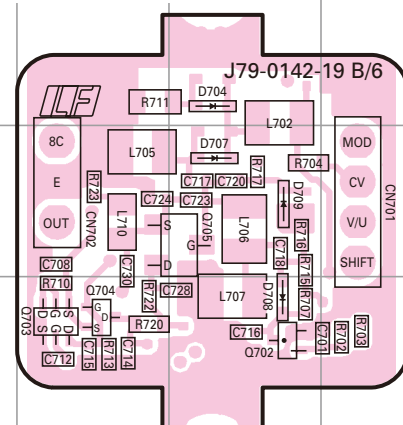

TX-RX UNIT (E/6) :
VCO A SECTION

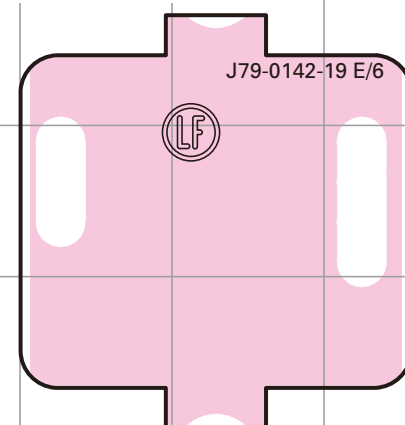

Ref. No.	Address	Ref. No.	Address	Ref. No.	Address	Ref. No.	Address
IC801	4H	Q704	13H	Q808	5P	D708	13I
IC802	7O	Q705	12I	Q809	6O	D709	12I
IC803	5O	Q752	13F	Q810	7J	D754	11F
IC804	8M	Q753	13E	Q811	7K	D757	12F
IC805	8J	Q754	13E	Q812	6N	D758	13F
IC806	6M	Q755	12F	Q816	7H	D759	12F
IC807	8N	Q801	7N	Q817	9M	D801	8N
IC951	3O	Q803	7I	Q951	8H	D802	8O
IC952	4L	Q804	6J	Q953	8H	D954	5P
IC953	8I	Q805	5P	Q955	5M	D956	5M
Q702	13I	Q806	6J	D704	11I	D957	9H
Q703	13H	Q807	6K	D707	12I		

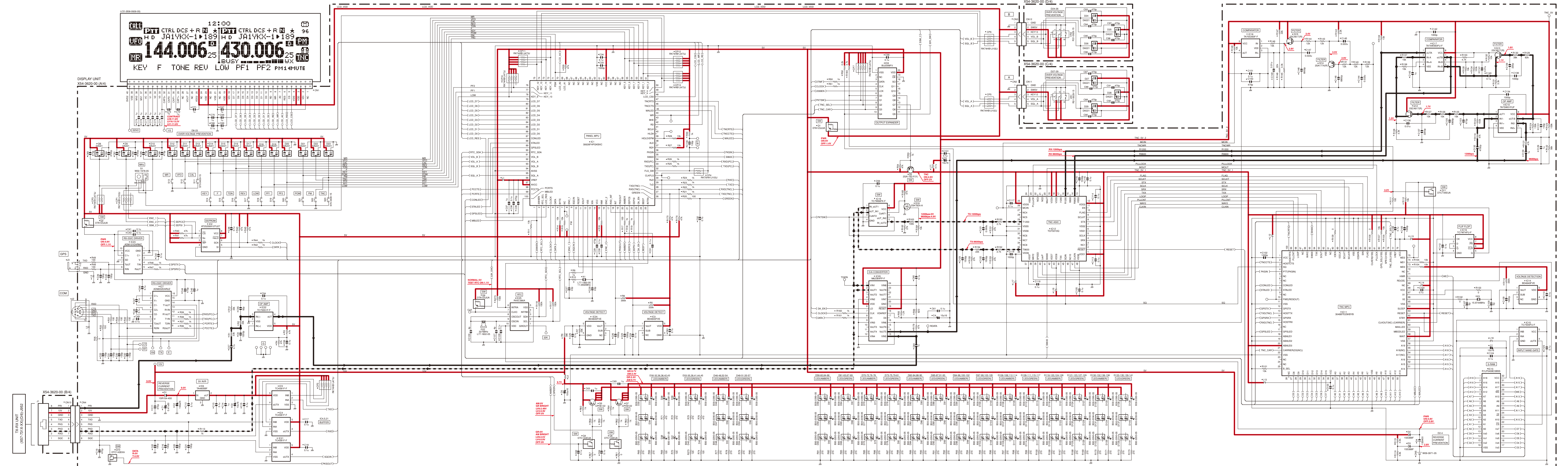

12:00
CTRL DCS + R *
H D JAIYKX-1 189
144.006 430.006
KEY F TONE REV LOW PF1 PF2 PM14MUTE

DISPLAY UNIT
X54-3620-00 (A4)

TX/RX UNIT
(A57-75 XX-XX)(B)J52

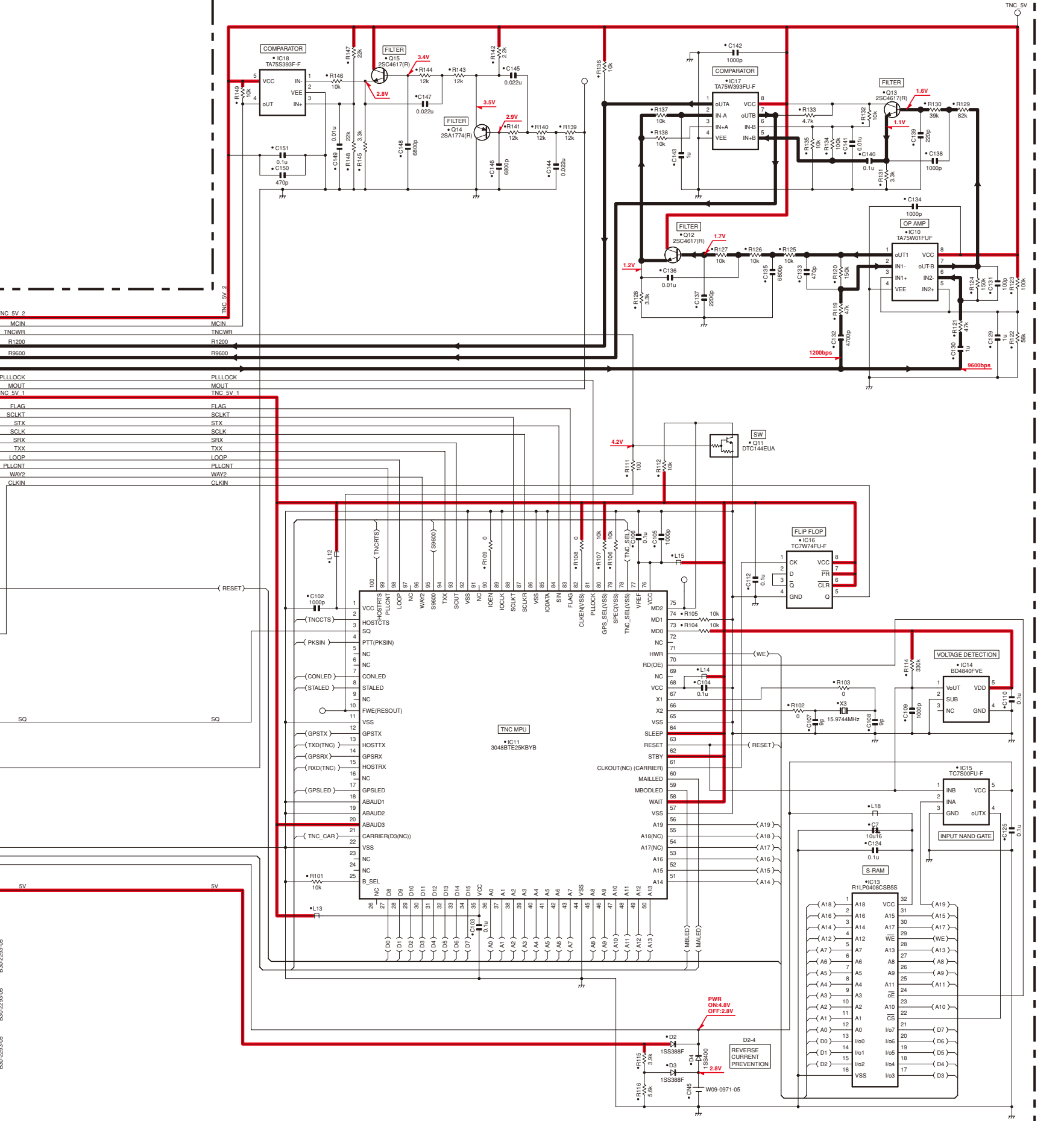
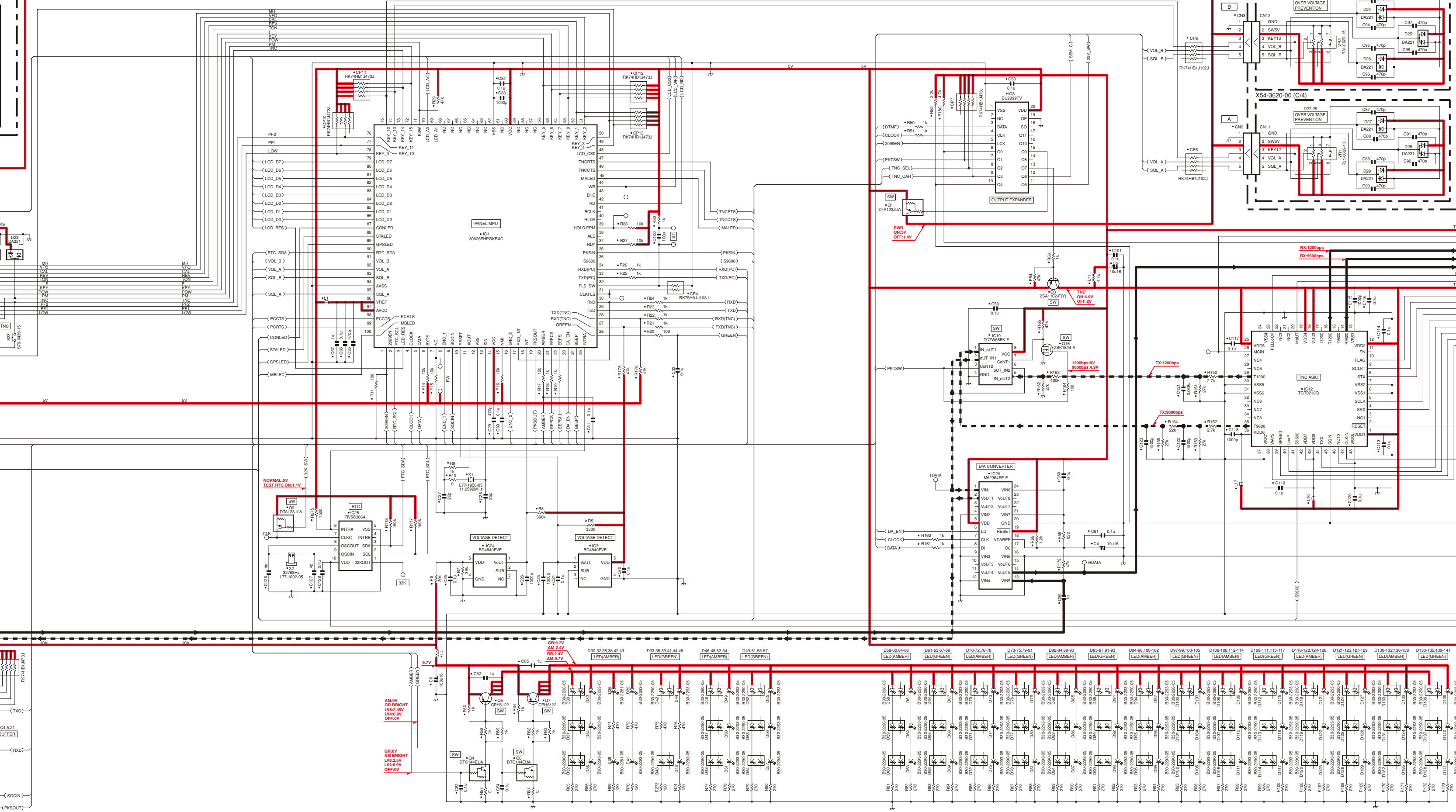
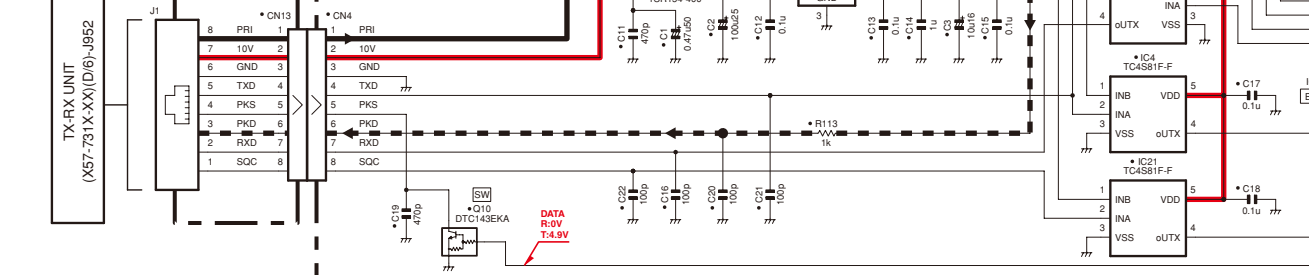

TX/RX UNIT
(A57-75 XX-XX)(B)J52

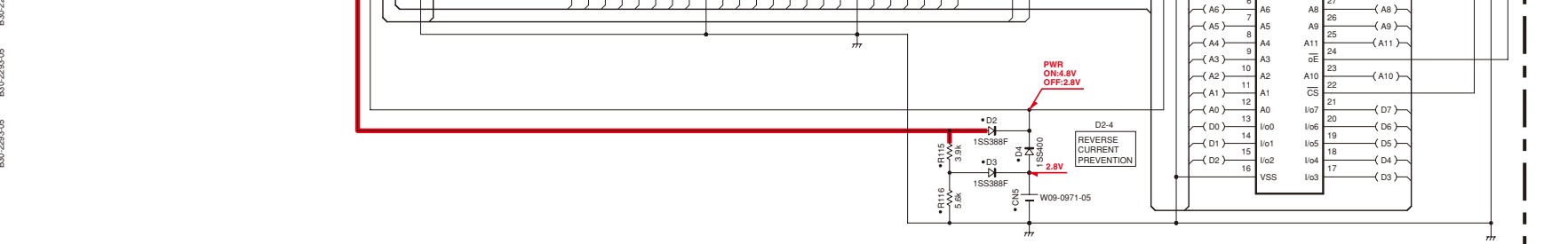



TX-RX UNIT (SET 721X, 2X1A, 1) TX-RX SECTION

NO.	SYMBOL	DESCRIPTION
1	1A	1A1
2	1A	1A2
3	1A	1A3
4	1A	1A4
5	1A	1A5
6	1A	1A6
7	1A	1A7
8	1A	1A8
9	1A	1A9
10	1A	1A10
11	1A	1A11
12	1A	1A12
13	1A	1A13
14	1A	1A14
15	1A	1A15
16	1A	1A16
17	1A	1A17
18	1A	1A18
19	1A	1A19
20	1A	1A20
21	1A	1A21
22	1A	1A22
23	1A	1A23
24	1A	1A24
25	1A	1A25
26	1A	1A26
27	1A	1A27
28	1A	1A28
29	1A	1A29
30	1A	1A30
31	1A	1A31
32	1A	1A32
33	1A	1A33
34	1A	1A34
35	1A	1A35
36	1A	1A36
37	1A	1A37
38	1A	1A38
39	1A	1A39
40	1A	1A40
41	1A	1A41
42	1A	1A42
43	1A	1A43
44	1A	1A44
45	1A	1A45
46	1A	1A46
47	1A	1A47
48	1A	1A48
49	1A	1A49
50	1A	1A50
51	1A	1A51
52	1A	1A52
53	1A	1A53
54	1A	1A54
55	1A	1A55
56	1A	1A56
57	1A	1A57
58	1A	1A58
59	1A	1A59
60	1A	1A60
61	1A	1A61
62	1A	1A62
63	1A	1A63
64	1A	1A64
65	1A	1A65
66	1A	1A66
67	1A	1A67
68	1A	1A68
69	1A	1A69
70	1A	1A70
71	1A	1A71
72	1A	1A72
73	1A	1A73
74	1A	1A74
75	1A	1A75
76	1A	1A76
77	1A	1A77
78	1A	1A78
79	1A	1A79
80	1A	1A80
81	1A	1A81
82	1A	1A82
83	1A	1A83
84	1A	1A84
85	1A	1A85
86	1A	1A86
87	1A	1A87
88	1A	1A88
89	1A	1A89
90	1A	1A90
91	1A	1A91
92	1A	1A92
93	1A	1A93
94	1A	1A94
95	1A	1A95
96	1A	1A96
97	1A	1A97
98	1A	1A98
99	1A	1A99
100	1A	1A100

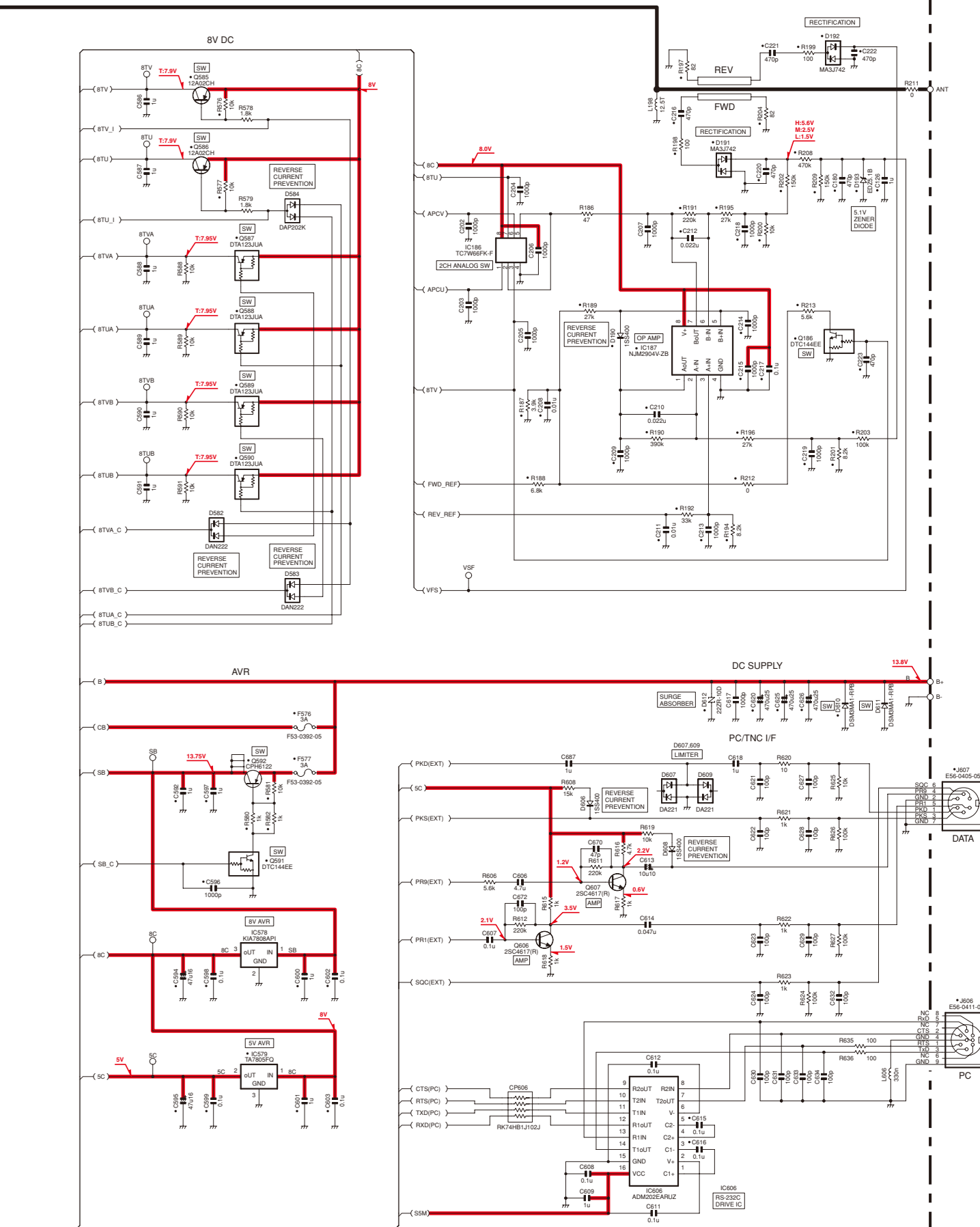

100	1A	1A100
101	1A	1A101
102	1A	1A102
103	1A	1A103
104	1A	1A104
105	1A	1A105
106	1A	1A106
107	1A	1A107
108	1A	1A108
109	1A	1A109
110	1A	1A110
111	1A	1A111
112	1A	1A112
113	1A	1A113
114	1A	1A114
115	1A	1A115
116	1A	1A116
117	1A	1A117
118	1A	1A118
119	1A	1A119
120	1A	1A120

121	1A	1A121
122	1A	1A122
123	1A	1A123
124	1A	1A124
125	1A	1A125
126	1A	1A126
127	1A	1A127
128	1A	1A128
129	1A	1A129
130	1A	1A130

TX-RX UNIT (X57-731X-XX)(D)(6) : CONTROL SECTION

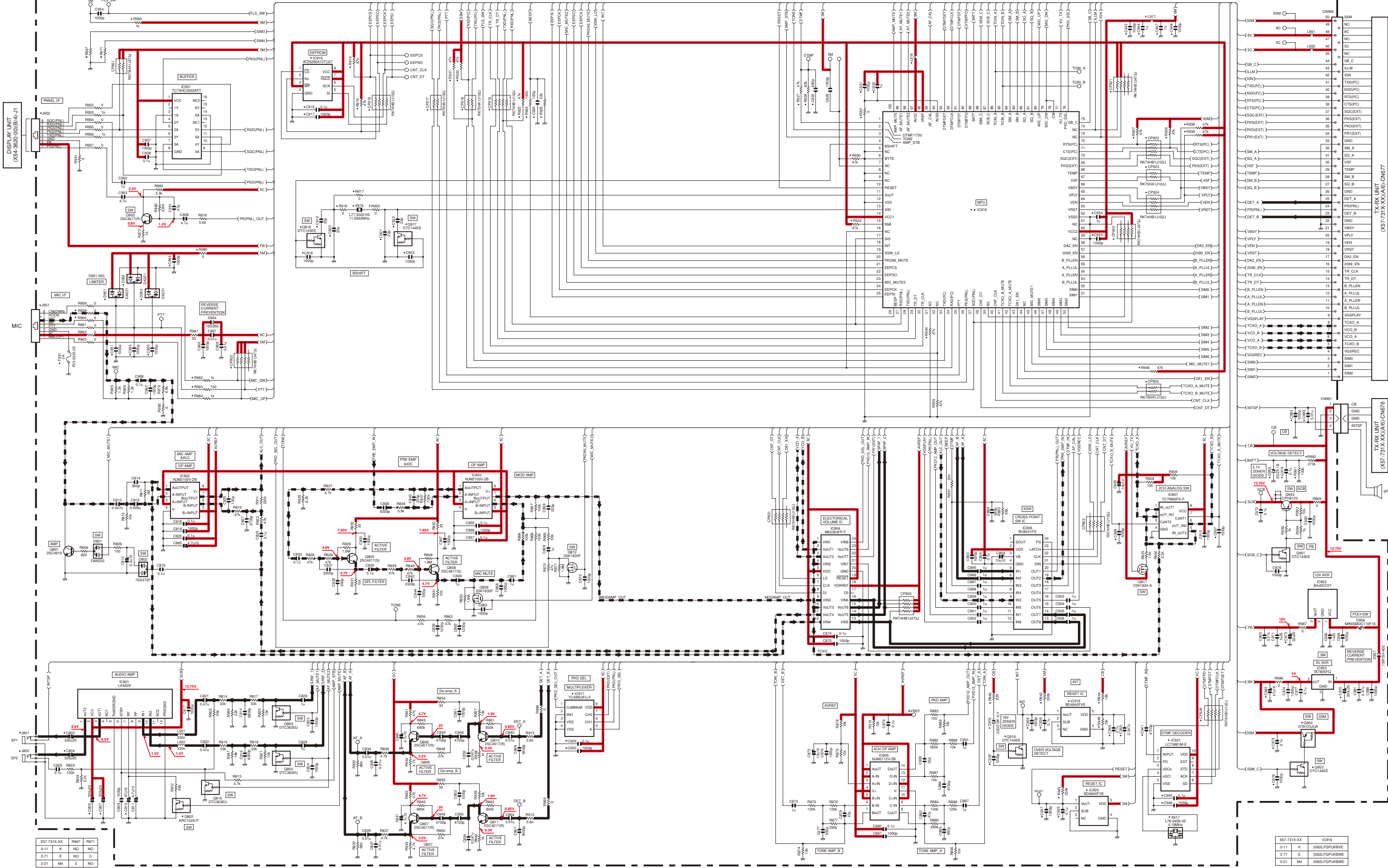

X57-731X-XX	R667	R671
0-11	K	NO
0-71	K	NO
0-21	M4	NO

X57-731X-XX	IC918
0-11	K
0-71	K
0-21	M4

